

	<h1>Product Specification</h1>	Specification Number	A196-20
		Revision	01

Part No. A196-20

Description Stainless Storage Drum with 1" Ferrule

Materials of Construction:

- Body: 316 stainless steel
- Ferrule: 316 stainless steel
- Lid: 316 stainless steel
- Clamp: 304 stainless steel
- Handles: 304 stainless steel
- Gasket: Silicone (FDA 177.2600 and USP Class VI compliant)

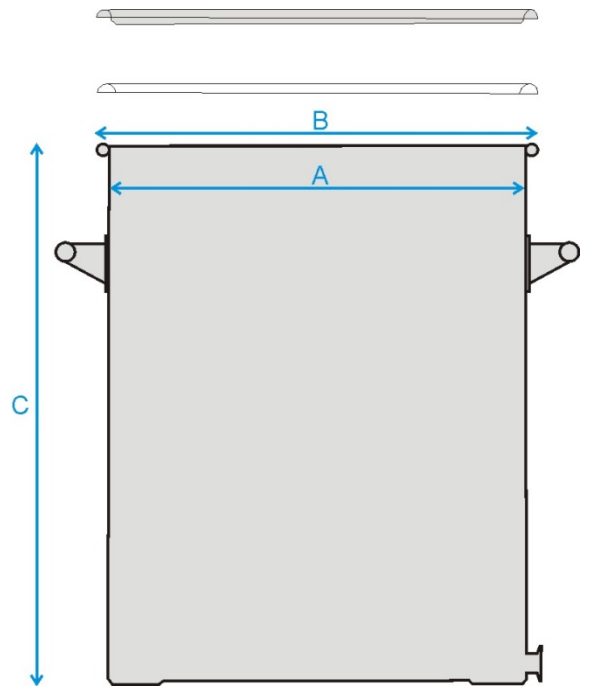

Nominal Volume: 20 Litres

Method of Construction: Welds ground and polished

Surface Finish: Better than 0.5 microns Ra

Dimensions  
A = 300 mm  
B = 320mm  
C = 310 mm

Graduation Marks: None

Handles: 2 side handles welded onto patch plates

Weight: 5.60 Kg (body + gasket + lid + clamp)

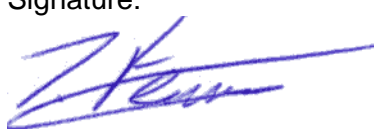
Specification Approved By:	Signature: 	Name: Jonathan Fenner Position: Director Date: 28-Sep-18
----------------------------	--	--