

1. Part Number: A926-30

2. Photograph:

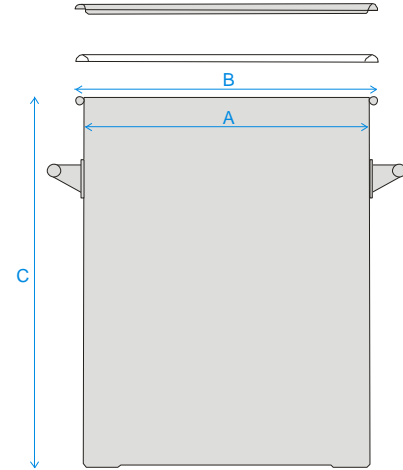

3. Product Information:

Description	Toggle Drum 30L
Materials of Construction:	<ul style="list-style-type: none"> - Body: 316L stainless steel - Lid: 316L stainless steel - Toggles: 304 stainless steel - Handles: 304 stainless steel - Gasket: Silicone (FDA 177.2600 compliant & BSE/TSE free)
Nominal Volume:	30 Litres
Brimful Volume:	31 Litres
Method of Construction:	Welds ground and polished
Surface Finish:	Better than 0.5 microns Ra
Dimensions	A = 300 mm B = 320 mm C = 450 mm
Graduation Marks:	None
Handles:	2 side handles welded onto patch plates
Number of Toggles:	4
Weight:	7.0 Kg (body + gasket + lid)
BSE/TSE statement:	All polishing compounds used in the manufacture of this product are of vegetable origin.
Recommended Storage Conditions:	Dry and ambient temperature

4. Approval:

Signed:



Name: Kuldeep Flora

Position: Quality Manager

Date: 13-Oct-20