

1. Part Number: A126-01

2. Photograph:

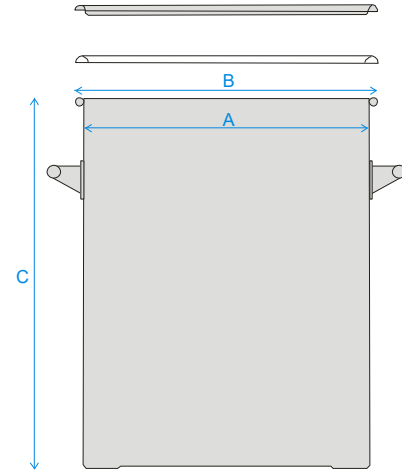

3. Product Information:

Description	Stainless Storage Drum 1L
Materials of Construction:	<ul style="list-style-type: none"> - Body: 316L stainless steel - Lid: 316L stainless steel - Clamp: 304 stainless steel - Handles: 304 stainless steel - Gasket: Silicone (FDA 177.2600 compliant & BSE/TSE free)
Nominal Volume:	1 Litres
Method of Construction:	Welds ground and polished
Surface Finish:	Better than 0.5 microns Ra
Dimensions	A = 140 mm B = 155 mm C = 90 mm
Drum Wall Thickness:	1.2mm
Graduation Marks:	None
Handles:	2 side handles welded onto patch plates
Weight:	1.19 Kg (body + gasket + lid + clamp)
BSE/TSE statement:	All polishing compounds used in the manufacture of this product are of vegetable origin.
Recommended Storage Conditions:	Dry and ambient temperature

4. Approval:

Signed:



Name: Kuldeep Flora

Position: Quality Manager

Date: 14-Aug-20