

BENCHTOP CENTRIFUGE

— ROTINA 380 | 380 R

HIGH SPEED WITH SPACE SAVING DESIGN

High performance unit supporting a wide array of accessories for multiple applications in just one rotor. Its size and performance make it the ideal bench top centrifuge for most clinical, research and industrial laboratories.

This unit is available with refrigeration and a temperature range from -20 °C to +40 °C (ROTINA 380 R).



— HIGHLIGHTS

- RPM: 50 - 15,000 min⁻¹
Adjustable in increments of 10
- RCF: 50 - 24,400
Adjustable in increments of 1
- max. capacity: 4 x 290 ml
- choice of 9 rotors
- IVD-conform according to directive 98/79/EC
- max. noise level of 54 dB(A) with rotor 1760
- easy operation with keypad and control knob
- 98 program memories for more individuality
- 9 individual acceleration and 10 deceleration stages
- model 380 R coolable from -20 to +40 °C with pre-cooling function

— FEATURES

- metal housing and lid
- viewing port in the lid
- powered one-hand lid lock
- lid dropping protection
- emergency lid lock release
- stainless steel chamber
- automatic rotor recognition
- brushless drive
- error display
- display in °C and °F possible
- imbalance switch-off
- backlit panel with actual values of all parameters
- auditory message after completion of the centrifugation run

TECHNICAL DATA

	ROTINA 380 non-refrigerated	ROTINA 380 R refrigerated
voltage *)	200 – 240 V 1 ~	200 – 240 V 1 ~
frequency	50 – 60 Hz	50 – 60 Hz
consumption	650 VA	1,300 VA
emission, immunity	EN/IEC 61326-1, class B	EN/IEC 61326-1, class B
max. capacity	4 x 290 ml	4 x 290 ml
max. RPM	15,000 min ⁻¹	15,000 min ⁻¹
max. RCF	24,400	24,400
running time	1 sec – 99 h: 59 min: 59 sec, ∞ continuous run, short cycle mode	1 sec – 99 h: 59 min: 59 sec, ∞ continuous run, short cycle mode
dimensions (WxDxH)	457x600x418 mm	457x750x418 mm
weight	approx. 51 kg	approx. 81 kg
noise level	54 dB (A) with rotor 1760	54 dB (A) with rotor 1760
temperature control, infinitely variable	-	from -20 to +40 °C
Cat. No.	1701	1706
100 – 127 V 1 ~ / 50 – 60 Hz *)	1701-01	1706-01
consumption	700 VA	1,400 VA
emission, immunity	FCC class B	FCC class B
weight	approx. 58.5 kg	approx. 88.5 kg

*) Other voltages on request.

AVAILABLE ROTORS

SWING-OUT ROTORS		angle	max. RPM	max. capacity	Cat. No.	page
	swing-out rotor, 4-place	90°	5,000 min ⁻¹	4x290 ml	1754	3
	swing-out rotor, 4-place	90°	4,000 min ⁻¹	4x290 ml	1798	5
	swing-out rotor, 6-place	90°	4,000 min ⁻¹	6x50 ml	1726	7
	swing-out rotor, 2-place	90°	4,000 min ⁻¹	10 plates	1760	9
	swing-out rotor, 2-place	90°	5,100 min ⁻¹	12 plates	1770	9
ANGLE ROTORS						
	angle rotor, 6-place	45°	10,000 11,000 min ⁻¹	6x94 ml	1720	10
	angle rotor, 6-place inclusive lid bioseal	45°	10,000 11,000 min ⁻¹	6x94 ml	1792	11
	angle rotor, 30-place	45°	15,000 min ⁻¹	30x2 ml	1789-A	12
	angle rotor, 8-place	45°	4,500 min ⁻¹	8x50 ml	1721	12

SWING-OUT ROTOR, 4-PLACE | 1754



Rotor

max. RPM max. RCF	5,000 min ⁻¹ 4,863
max. capacity	4 x 290 ml
run-up run-down, braked in sec	42 27
angle max. noise level	90° 60 dB (A)
temperature in °C ¹⁾	0
Cat. No.	1754



Bucket

lid bioseal ⁵⁾	1751
Cat. No.	1752

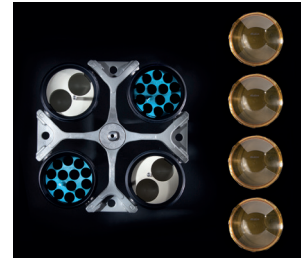

Vessels

capacity in ml	1.5	2.0	3	4	5	6	7	9	15	20	25	45	50	94	100
Ø x L in mm	11 x 38	11 x 38	10 x 60	12 x 60	12 x 75	12 x 82	12 x 100	14 x 100	17 x 100	21 x 100	24 x 100	31 x 100	34 x 100	38 x 102	40 x 115
max. RCF ²⁾	3,494 / 4,779	3,494 / 4,779	4,779	4,668	4,668	4,668	4,668	4,668	4,668	4,668	4,668	4,668	4,668	4,807	4,640
radius in mm	125 / 171	125 / 171	171	167	167	167	167	167	167	167	167	167	167	172	166
Cat. No.	microliter tubes			tubes²⁾											



Adapter

boring Ø x L in mm	11.2x39.5	11.2x39.5	11.2x39.5	12.5x56	12.5x56	12.5x56	12.5x56	12.5x56	17.5x62	17.5x62	25.5x81	25.5x81	35.5x81	35.5x81	38.5x80	41x97
vessels per rotor	144	144	72	96	96	96	96	96	52	52	24	24	12	12	8	4
Cat. No.	1761	1761	1761	1762-A	1762-A	1762-A	1762-A	1762-A	1763-A	1763-A	1764	1764	1765	1765	1777	1767

Vessels

capacity in ml	100	250	1.1-1.4	2.6-3.4	2.7-3	4-5.5	4.5-5	4.5-5	4.9	4.9	7.5-8.5	9-10	10	1.6-5	4-7
Ø x L in mm	44 x 100	65 x 115	8 x 66	13 x 65	11 x 66	15 x 75	11 x 92	11 x 92	13 x 90	13 x 90	15 x 92	16 x 92	15 x 102	13 x 75	13 x 100
max. RCF ²⁾	4,640	4,640	4,668	4,668	4,668	4,668	4,668	4,668	4,668	4,668	4,668	4,668	4,668	4,668	4,668
radius in mm	166	166	167	167	167	167	167	167	167	167	167	167	167	167	167
Cat. No.	tubes²⁾		blood collection tubes / urine tubes												



Adapter

boring Ø x L in mm	45 x 87	66 x 104.5	9 x 49	13.5 x 54	12.5 x 56	17.5 x 62	12.5 x 56	13.2 x 72	13.5 x 54	13.2 x 72	17.5 x 62	17.5 x 62	17.5 x 62	13.5 x 54	13.5 x 54
vessels per rotor	4	4	96	64	96	52	96	76	64	76	52	52	52	64	64
Cat. No.	1766	1768	1781	1783-A	1762-A	1763-A	1762-A	1787	1783-A	1787	1763-A	1763-A	1763-A	1783-A	1783-A

1) For cooled versions: Lowest temperature achievable with precooling and max. speed.
 2) Please note that the RCF values indicated refer only to rotor performance. The max. permissible RCF of tubes used should be verified with the individual manufacturers. The max. RCF for glass tubes annotated with footnote 2) is 4,000.
 5) Tested by the TÜV in conformity with DIN EN 61010, section 2 - 020.

SWING-OUT ROTOR, 4-PLACE | 1754



Rotor	
max. RPM max. RCF	5,000 min ⁻¹ 4,863
max. capacity	4 x 290 ml
run-up run-down, braked in sec	42 27
angle max. noise level	90° 60 dB (A)
temperature in °C ¹⁾	0
Cat. No.	1754



Bucket	
lid bioseal ⁵⁾	1751
Cat. No.	1752

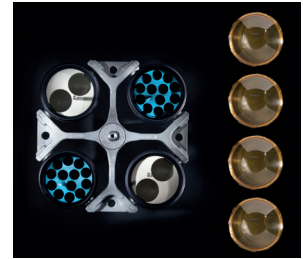

Vessels																
capacity in ml		4-7	4-7	8	8,5-10	5	15	50	12	25	30	50	50	14	10	30
Ø x L in mm		13x100	16x75	16x125	16x100	17x59	17x120	29 x 115	17x100	25x90	25x110	29x115	29x115	16,5x106	16x80	26x95
max. RCF ²⁾		4,668	4,668	4,668	4,668	4,863	4,863	4,863	4,696	4,528	4,528	4,752	4,752	4,668	4,668	4,807
radius in mm		167	167	167	167	174	174	174	168	162	162	170	170	167	167	172
Cat. No.		blood collection tubes / urine tubes				-	tubes with screw cap									

Adapter																
boring Ø x L in mm		13.2x72	17.5x62	17.5x62 ²¹⁾	17.5x62	17x52	17x84	30x84	17x78	26.5x72	26.5x72	30x80	30x80	17.5x62	17.5x62	26.5x70
vessels per rotor		76	52	12	52	32	36	16	36	20	20	16	16	52	52	24
Cat. No.		1787	1763-A	1763-A	1763-A	1738	1771-A	1772-A	1773	1779	1779	1774-A	1774-A	1763-A	1763-A	1775

Vessels										
capacity in ml		50	85	94	175	175 ^{3.3)}	200	225	250	290 ^{3.3)}
Ø x L in mm		29x107	38x106	38x102	61 x 118	62 x 144	60 x 130	61 x 137	61 x 122	62 x 137
max. RCF ²⁾		4,752	4,807	4,807	4,863	4,863	4,863	4,863	4,863	4,863
radius in mm		170	172	172	174	174	174	174	174	174
Cat. No.		tubes with screw cap			Falcon	Nalgene	Nunc [®]	Falcon	5127 ²⁴⁾	- ²⁴⁾

Adapter										
boring Ø x L in mm		30 x 80	38.5 x 80	38.5 x 80	62 x 111	62 x 111	62 x 111	62 x 111	62 x 100	62 x 100
vessels per rotor		16	8	8	4	4	4	4	4	4
Cat. No.		1774-A	1777	1777	1782	1778	1778	1782	1769	1769

1) For cooled versions: Lowest temperature achievable with precooling and max. speed.
 2) Please note that the RCF values indicated refer only to rotor performance. The max. permissible RCF of tubes used should be verified with the individual manufacturers. The max. RCF for glass tubes annotated with footnote 2) is 4,000.
 3.3) When using these tubes, bucket 1752 or 5051 cannot be closed with lid 1751 or 5053.
 5) Tested by the TÜV in conformity with DIN EN 61010, section 2 - 020.
 13) Tube No. 0538 also available with screwing cap. Dimensions with cap 38 x 110 mm. Cat. No. 0539.
 21) Adapter must be loaded as illustrated.
 24) At temperatures of over +40 °C and / or when not filled to capacity, bottles may warp during centrifugation.

SWING-OUT ROTOR, 4-PLACE | 1798



Rotor

max. RPM max. RCF	4.000 min ¹⁾ 2,898
max. capacity	4 x 100 ml
run-up run-down, braked in sec	24 17
angle max. noise level	90° 55 dB (A)
temperature in °C ¹⁾	-8
Cat. No.	1798

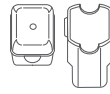

Bucket

lid	5053
Cat. No.	5051

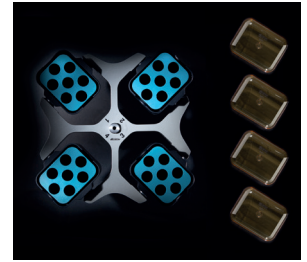

Vessels

capacity in ml	1.5	2	1.5	2	3	5	6	7	9	15	25	50	100	100
Ø x L in mm	11 x 38	11 x 38	11 x 38	11 x 38	10 x 60	12 x 75	12 x 82	12 x 100	14 x 100	17 x 100	24 x 100	34 x 100	40 x 115	44 x 100
max. RCF ²⁾	top / bottom		1,950 / 2,826	1,950 / 2,826	2,826	2,826	2,737	2,773	2,773	2,755	2,773	2,755	2,755	2,755
radius in mm	109 / 158	109 / 158	158	158	153	155	155	154	155	154	154	154	154	154
Cat. No.	microliter tubes							tubes²⁾						



Adapter

boring Ø x L in mm	12.5 x 42	12.5 x 42	11.5 x 50	11.5 x 50	11 x 44	12.5 x 42	12.5 x 42	12.5 x 86	16 x 50	17.5 x 86	26 x 86	36 x 86	42 x 86	45.5 x 86
vessels per rotor	160	160	64	64	80	80	80	80	48	48	20	8	4	4
Cat. No.	5257	5257	5281	5281	5267	5227	5227	5247¹⁵⁾	5264	5248¹⁵⁾	5242	5243	5249	5262

Vessels

capacity in ml	1.1–1.4	2.6–3.4	2.7–3	4–5.5	4.5–5	4.9	7.5–8.5	9–10	10	1.6–5	4–7	4–7	8.5–10
Ø x L in mm	8 x 66	13 x 65	11 x 66	15 x 75	11 x 92	13 x 90	15 x 92	16 x 92	15 x 102	13 x 75	13 x 100	16 x 75	16 x 100
max. RCF ²⁾	2,737	2,808	2,773	2,773	2,773	2,808	2,773	2,755	2,755	2,808	2,808	2,773	2,755
radius in mm	153	157	155	155	155	157	155	154	154	157	157	155	154
Cat. No.	blood collection tubes / urine tubes												



Adapter

boring Ø x L in mm	11 x 44	13.5 x 52	12.5 x 42	16 x 50	12.5 x 42	13.5 x 52	16 x 50	17.6 x 86	17.6 x 86	13.5 x 52	13.5 x 52	16 x 50	17.5 x 86
vessels per rotor	80	48	80	48	80	48	48	44	44	48	48	48	48
Cat. No.	5267	5268	5227	5264	5227	5268	5264	5258	5258	5268	5268	5264	5248

Vessels

capacity in ml	30	50	15	12	30	50	1–8		
Ø x L in mm	25 x 110	29 x 115	17 x 120	17 x 100	25 x 110	29 x 115	simple / multiple		
max. RCF ²⁾	top / bottom		2,755	2,826	2,898	2,898	2,755	2,755	1,735 / 2,737
radius in mm	154	158	162	162	154	154	97 / 153		
Cat. No.	tubes with screw cap						cyto chambers		



Adapter

boring Ø x L in mm	26 x 86	30 x 86	17 x 90	17 x 90	26 x 86	36 x 86	-
vessels per rotor	20	8	28	28	20	8	8
Cat. No.	5266	5259	6306	6306	5266	5243	5280

- 1) For cooled versions: Lowest temperature achievable with precooling and max. speed.
- 2) Please note that the RCF values indicated refer only to rotor performance. The max. permissible RCF of tubes used should be verified with the individual manufacturers. The max. RCF for glass tubes annotated with footnote 2) is 4,000.
- 3.3) When using these tubes, bucket 1752 or 5051 cannot be closed with lid 1751 or 5053.
- 15) Also available with decanting aid. (Cat. No. 5247-91 or 5248-91).

SWING-OUT ROTOR, 4-PLACE | 1798



Rotor	
max. RPM max. RCF	4,000 min ⁻¹ 3,095
max. capacity	4 x 290 ml
run-up run-down, braked in sec	24 17
angle max. noise level	90° 56 dB (A)
temperature in °C ¹⁾	-8
Cat. No.	1798



Bucket	
lid bioseal ⁵⁾	5093
Cat. No.	5092

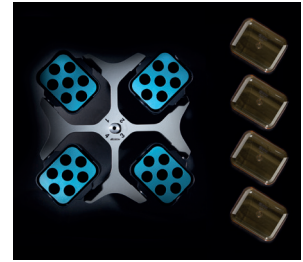

Vessels															
capacity in ml	5	6	7	15	25	50	100	100	250	15	30	50	12	25	30
Ø x L in mm	12x75	12x82	12x100	17x100	24x100	34x100	44x100	40x115	65x115	17x120	25 x 110	29x115	17x100	25x90	25x110
max. RCF ²⁾	3,005	3,005	3,005	2,952	2,898	2,952	2,952	2,952	3,095	3,095	2,898	3,095	3,005	2,826	2,898
radius in mm	168	168	168	165	162	165	165	165	173	173	162	173	168	158	162
Cat. No.	tubes²⁾									tubes with screw cap					

Adapter															
boring Ø x L in mm	12.8x45	12.8x45	12.8x82	17.5x60.7	25.5x82	35.5x85	45.5x85	42x85	66x103	17x85	25.5x82	30x85	17.5x82	26x73	25.5x82
vessels per rotor	48	48	48	32	16	4	4	4	4	28	16	8	28	12	16
Cat. No.	5128	5128	5120	5136	5122	5124	5125	5126	1791	5129	5122	5123	5121	5134	5122

Vessels															
capacity in ml	50	10	250	290	1.1-1.4	2.6-3.4	2.7-3	4-5.5	4.5-5	4.9	7.5-8.5	9-10	10	1.6-5	4-7
Ø x L in mm	29x115	16 x 80	61 x 122	62 x 137	8 x 66	13 x 65	11x66	15x75	11x92	13x90	15x92	16x92	15x102	13x75	16x75
max. RCF ²⁾	3,023	2,952	3,095	3,095	2,540	2,540	2,540	2,952	3,005	2,952	2,952	2,952	2,952	2,540	2,952
radius in mm	169	165	173	173	142	142	142	165	168	165	165	165	165	142	165
Cat. No.	tubes with screw cap		5127²⁴⁾	-²⁴⁾	blood collection tubes / urine tubes										

Adapter															
boring Ø x L in mm	30x99	17.5x60.7	66x103	66x103	13x54.5	13x54.5	13x54.5	17.5x60.7	12.8x82	13.5x60.7	17.5x60.7	17.5x60.7	17.5x60.7	13x54.5	17.5x60.7
vessels per rotor	8	32	4	4	48	48	48	32	48	32	32	32	32	48	32
Cat. No.	5135	5136	6319	6319	5138	5138	5138	5136	5120	5137	5136	5136	5136	5138	5136

Vessels				
capacity in ml	4-7	4-7	8	8.5-10
Ø x L in mm	16x75	13x100	16x125	16x100
max. RCF ²⁾	3,005	3,005	3,059	2,952
radius in mm	168	168	171	165
Cat. No.	blood collection / urine tubes			

Adapter				
boring Ø x L in mm	17.5x52	12.8x82	17.5x82	17.5x60.7
vessels per rotor	28	48	28	32
Cat. No.	5121-93	5120	5121⁴⁾	5136

1) For cooled versions: Lowest temperature achievable with precooling and max. speed.
 2) Please note that the RCF values indicated refer only to rotor performance. The max. permissible RCF of tubes used should be verified with the individual manufacturers.
 The max. RCF for glass tubes annotated with footnote 2) is 4,000.
 3.5) When using these tubes, bucket 5092 cannot be closed with lid 5093.
 4) Please remove the spacer.
 24) At temperatures of over +40 °C and / or when not filled to capacity, bottles may warp during centrifugation.

SWING-OUT ROTOR, 6-PLACE | 1726



Rotor	
max. RPM max. RCF	4,000 min ⁻¹ 2,808
max. capacity	6 x 50 ml
run-up run-down, braked in sec	19 18
angle	90°
temperature in °C ¹⁾	-6
Cat. No.	1726

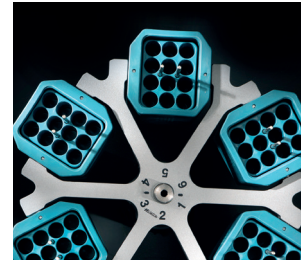

Vessels														
capacity in ml	5	5	6	7	9	15	20	25	45	50	8.5 x 10	30	1-8	
Ø x L in mm	12x75	12x75	12x82	12x100	14x100	17x100	21x100	24x100	31x100	34x100	16x100	26x95	simple / multiple	
max. RCF ²⁾	2,576	2,522	2,665	2,665	2,665	2,665	2,719	2,808	2,719	2,808	2,665	2,808	2,003	
radius in mm	144	141	149	149	149	149	152	157	152	157	149	157	112	
Cat. No.	tubes²⁾											-	-	cyto chambers
Carrier														
boring Ø x L in mm	12.5x64.4	13.5x65	12.5x71.5	12.5x71.5	14.6x74	17.6x74	21.5x74	26x78	32x74	35x78	17.6x74	26x78	-	
vessels per rotor	24	102	24	24	30	24	12	12	6	6	24	12	6	
Cat. No.	1369-91	1372	1369-92	1369-92	1370	1369	1346	1745	1345	1746	1369	1745	1660	

SWING-OUT ROTOR, 6-PLACE | 1726



Rotor	
max. RPM max. RCF	4,000 min ⁻¹ 2,808
max. capacity	42 x 15 ml
run-up run-down, braked in sec	19 18
angle max. noise level	90° 54 dB (A)
temperature in °C ¹⁾	-6
Cat. No.	1726

Carrier	
Cat. No.	1742



Vessels										
capacity in ml	15	2.6-3.4	4-5.5	7.5-8.5	9-10	10	1.6-5	4-7	8.5-10	15
Ø x L in mm	17x100	13x65	15x75	15x92	16x92	15x102	13x75	16x75	16x100	17x120
max. RCF ²⁾	2,808	2,683	2,683	2,808	2,808	2,808	2,683	2,683	2,808	2,808
radius in mm	157	150	150	157	157	157	150	150	157	157
Cat. No.	-²⁾	blood collection tubes / urine tubes								-
Adapter										
boring Ø x L in mm	17.6 x 78	17.6 x 78	17.6 x 78	17.6 x 78	17.6 x 78	17.6 x 78	17.6 x 78	17.6 x 78	17.6 x 78	17.6 x 78
vessels per rotor	42	42	42	42	42	18	42	42	42	18
Cat. No.	-	0716	0716	-	-	-	0716	0716	-	-

1) For cooled versions: Lowest temperature achievable with precooling and max. speed.

2) Please note that the RCF values indicated refer only to rotor performance. The max. permissible RCF of tubes used should be verified with the individual manufacturers. The max. RCF for glass tubes annotated with footnote 2) is 4,000.

21) Adapter must be loaded as illustrated.

SWING-OUT ROTOR, 6-PLACE | 1726



Rotor	
max. RPM max. RCF	4,000 min ⁻¹ 2,325
max. capacity	72 x 4 ml
run-up run-down, braked in sec	19 18
angle max. noise level	90° 54 dB (A)
temperature in °C ¹⁾	-6
Cat. No.	1726



Bucket	
Cat. No.	1366

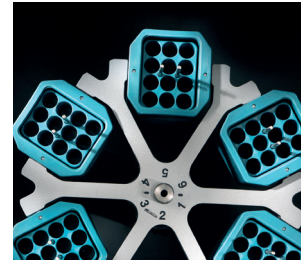

Vessels					
capacity in ml	1.5	2.0	1	3	4
Ø x L in mm	11 x 38	11 x 38	6 x 45	10 x 60	12 x 60
max. RCF ²⁾	2,325	2,325	2,308	2,290	2,290
radius in mm	130	130	129	128	128
Cat. No.	microliter tubes	Rhesus	tubes²⁾		



Adapter					
boring Ø x L in mm	11.5 x 38	11.5 x 38	6.5 x 23	10.5 x 23	12.5 x 44
vessels per rotor	54	54	180	72	72
Cat. No.	5277	5277	1357	1327	1326

SWING-OUT ROTOR, 6-PLACE | 1726



Rotor	
max. RPM max. RCF	4,000 min ⁻¹ 2,808
max. capacity	60 x 9 ml
run-up run-down, braked in sec	19 18
angle max. noise level	90° 54 dB (A)
temperature in °C ¹⁾	-6
Cat. No.	1726



Carrier	
Cat. No.	1741



Vessels						
capacity in ml	9	1.1 - 1.4	4.5 - 5	4.9	1.6 - 5	4 - 7
Ø x L in mm	14 x 100	8 x 66	11 x 92	13 x 90	13 x 75	13 x 100
max. RCF ²⁾	2,773	2,773	2,808	2,808	2,486	2,808
radius in mm	155	155	157	157	139	157
Cat. No.	-²⁾	blood collection tubes / urine tubes				



Adapter					
boring Ø x L in mm	14.6 x 78	14.6 x 78	14.6 x 78	14.6 x 78	14.6 x 78
vessels per rotor	60	60	36	60	60
Cat. No.	0701	0701	-	-	6x0768¹⁶⁾

1) For cooled versions: Lowest temperature achievable with precooling and max. speed.
 2) Please note that the RCF values indicated refer only to rotor performance. The max. permissible RCF of tubes used should be verified with the individual manufacturers. The max. RCF for glass tubes annotated with footnote 2) is 4,000.
 16) Packaging unit 10 pieces.
 21) Adapter must be loaded as illustrated.

— SWING-OUT ROTOR, 2-PLACE | 1760

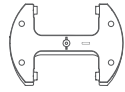

Rotor

max. RPM max. RCF	4,000 min ⁻¹ 2,397
max. capacity	10 plates
run-up run-down, braked in sec	30 23
angle max. noise level	90° 54 dB (A)
temperature in °C ¹⁾	-8
Cat. No.	1760



Plates

W x D x H in mm	128x86x15	128x86x17.5	128x86x22	128x86x44.5	128x86x46	128x86x83	84x59x11	124x82x20	-
capacity in ml	-	-	-	-	-	-	-	-	0,2
max. RCF ²⁾	2,397	2,397	2,397	2,397	2,397	2,397	2,397	2,397	2,397
radius in mm	134	134	134	134	134	134	134	134	134
Cat. No.	MTP	MTP	CP	DWP	MS	QP	Microtest plates	PCR plate	PCR strips



Bucket

boring Ø x L in mm	-	-	-	-	-	-	-	-	-
plates / strips per rotor	10	8	6	2	2	2	4	2	24 x 8
Cat. No.	1753-A	1753-A	1753-A	1753-A	1753-A	1753-A	1753-A	1753-A+1485	1753-A+1485

— SWING-OUT ROTOR, 2-PLACE | 1770

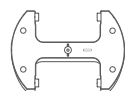

Rotor

max. RPM max. RCF	5,100 min ⁻¹ 3,926
capacity in ml	12 plates
run-up run-down, braked in sec	65 30
angle	90°
temperature in °C ¹⁾	-3
Cat. No.	1770



Bucket

lid bioseal ⁵⁾	4627
Cat. No.	4745



Plates

W x D x H in mm	128x86x15	128x86x17.5	128x86x22	128x86x44.5	128x86x46	128x86x83	84x59x11	124x82x20	-
Ø x L in mm	-	-	-	-	-	-	-	-	0,2
max. RCF ²⁾	3,926	3,926	3,926	3,926	3,926	3,926	3,926	3,926	3,926
radius in mm	135	135	135	135	135	135	135	135	135
Cat. No.	MTP	MTP	CP	DWP	MS	QP	Microtest plates	PCR plate	PCR strips



Removal frame

boring Ø x L in mm	-	-	-	-	-	-	-	-	-
plates / strips per rotor	12	10	8	2	2	2	4	2	24 x 8
Cat. No.	4626	4626	4626	4626	4626	4626	4626	4626 + 1485	4626 + 1485

1) For cooled versions: Lowest temperature achievable with precooling and max. speed.

2) Please note that the RCF values indicated refer only to rotor performance. The max. permissible RCF of tubes used should be verified with the individual manufacturers. The max. RCF for glass tubes annotated with footnote 2) is 4,000.

5) Tested by the TÜV in conformity with DIN EN 61010, section 2 - 020.

ANGLE ROTOR, 6-PLACE | 1720



Rotor

max. RPM	ROTINA 380 380 R	10,000 min ⁻¹ 11,000 min ⁻¹
max. RCF		13,528 16,369
max. capacity		6 x 94 ml
run-up / run-down, braked in sec		39 / 36 45 / 44
angle max. noise level		45° 59 dB (A)
temperature in °C ¹⁾		+1
Cat. No.		1720

Vessels

capacity in ml	1.5	2.0	15	25	50	94	7.5-8.5	9-10	8.5-10	5	15	50	10	30	50	
Ø x L in mm	11 x 38	11 x 38	17 x 100	24 x 100	34 x 100	38 x 102	15 x 92	16 x 92	16 x 100	17 x 59	17 x 120	29 x 115	16 x 80	26 x 95	29 x 107	
max. RCF ²⁾	ROTINA 380	12,969	12,969	12,745	12,410	13,304	13,528	12,745	12,745	12,745	12,857	13,081	12,745	12,410	12,410	12,969
max. RCF ²⁾	ROTINA 380 R	15,692	15,692	15,422	15,016	16,098	16,369	15,422	15,422	15,422	15,557	15,828	15,422	15,016	15,016	15,692
radius in mm	116	116	114	111	119	121	114	114	114	115	117	114	111	111	116	
Cat. No.	microliter tubes			tubes²⁾			blood collection tubes / urine tubes			-	tubes with screw cap					



Adapter

boring Ø x L in mm	11.4 x 39	11.4 x 39	17.5 x 92	26 x 85	35 x 89	38.4 x 89	17.5 x 92	17.5 x 92	17.5 x 92	17 x 51	17 x 106	29.8 x 97	16.5 x 74	26 x 85	29 x 92
vessels per rotor	24	24	6	6	6	6	6	6	6	6	6	6	12	6	6
Cat. No.	1449	1449	1451	1447	1463	-	1451	1451	1451	1476	1466	1454	1448	1447	1446

Vessels

capacity in ml	85	94	
Ø x L in mm	38 x 106	38 x 102	
max. RCF ²⁾	ROTINA 380	13,528	13,528
max. RCF ²⁾	ROTINA 380 R	16,369	16,369
radius in mm	121	121	
Cat. No.	tubes with screw cap		



Adapter

boring Ø x L in mm	38.4 x 89	38.4 x 89
vessels per rotor	6	6
Cat. No.	-	-

1) For cooled versions: Lowest temperature achievable with precooling and max. speed.

2) Please note that the RCF values indicated refer only to rotor performance. The max. permissible RCF of tubes used should be verified with the individual manufacturers. The max. RCF for glass tubes annotated with footnote 2) is 4,000.

— ANGLE ROTOR, 6-PLACE | 1792

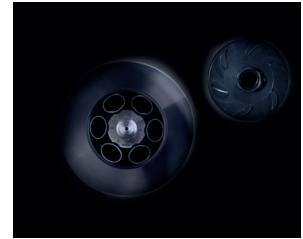

Rotor

max. RPM	ROTINA 380 380 R	10,000 min ⁻¹ 11,000 min ⁻¹
max. RCF		13,640 16,504
max. capacity		6 x 94 ml
run-up run-down, braked in sec		40 / 37 48 / 44
angle max. noise level		45° 59 dB (A)
temperature in °C ¹⁾		+4
Cat. No.		1792

lid bioseal⁵⁾

Cat. No.	INCLUSIVE
-----------------	------------------

Vessels

capacity in ml	1.5	2.0	15	25	50	94	7.5 – 8.5	9 – 10	10	8.5 – 10	5	15	50	10	30	
Ø x L in mm	11 x 38	11 x 38	17 x 100	24 x 100	34 x 100	38 x 102	15 x 92	16 x 92	15 x 102	16 x 100	17 x 59	17 x 120	29 x 115	16 x 80	26 x 95	
max. RCF ²⁾	ROTINA 380	13,081	13,081	12,857	12,522	13,416	13,640	12,857	12,857	12,857	12,857	12,745	13,081	13,304	12,857	12,522
max. RCF ²⁾	ROTINA 380 R	15,828	15,828	15,557	15,151	16,233	16,504	15,557	15,557	15,557	15,557	15,422	15,828	16,098	15,557	15,151
radius in mm	117	117	115	112	120	122	115	115	115	115	114	117	119	115	112	
Cat. No.	microliter tubes			tubes²⁾			blood collection tubes / urine tubes				tubes with screw cap					

Adapter

boring Ø x L in mm	11.4x39	11.4x39	17.5x92	26x85	35x89	38.2x89.6	17.5x92	17.5x92	17.5x92	17.5x92	17x51	17x106	29.8x97	16.5x74	26x85
vessels per rotor	24	24	6	6	6	6	6	6	6	6	6	6	6	12	6
Cat. No.	1449	1449	1451	1447	1463	-	1451	1451	1451	1451	1476	1466	1454	1448	1447

Vessels

capacity in ml	50	85	
Ø x L in mm	29 x 107	38 x 106	
max. RCF ²⁾	ROTINA 380	13,081	13,640
max. RCF ²⁾	ROTINA 380 R	15,828	16,504
radius in mm	117	122	
Cat. No.	tubes with screw cap		

Adapter

boring Ø x L in mm	29 x 92	38.2 x 89.6
vessels per rotor	6	6
Cat. No.	1446	-

1) For cooled versions: Lowest temperature achievable with precooling and max. speed.
 2) Please note that the RCF values indicated refer only to rotor performance. The max. permissible RCF of tubes used should be verified with the individual manufacturers. The max. RCF for glass tubes annotated with footnote 2) is 4,000.
 5) Tested by the TÜV in conformity with DIN EN 61010, section 2 - 020.

— ANGLE ROTOR, 30-PLACE | 1789-A



Rotor

max. RPM max. RCF	15,000 min ⁻¹ 24,400 min ⁻¹
max. capacity	30 x 2 ml
run-up run-down, braked in sec	24 24
angle max. noise level	45° 60 dB (A)
temperature in °C ¹⁾	+4
Cat. No.	1789-A



Lid bioseal[®], phenol-resistant

Cat. No.

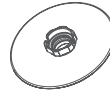

INCLUSIVE

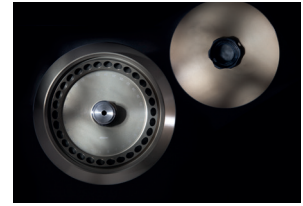

Vessels

capacity in ml	0.2	0.4	0.5	0.8	1.5	2	0.5
Ø x L in mm	6x18	6x45	8x30	8x45	11x38	11x38	10,7x36
max. RCF ²⁾	24,400	24,400	24,400	24,400	24,400	24,400	23,394
radius in mm	97	97	97	97	97	97	93
Cat. No.	microliter tubes						Pediatric



Adapter

boring Ø x L in mm	6x40	6x40	8x40	8x40	-	11,2x40,9	11,2x40,9
vessels per rotor	30	30	30	30	30	30	15
Cat. No.	2024	2024	2023	2023	2031⁷⁾	-	0788¹⁷⁾

— ANGLE ROTOR, 8-PLACES | 1721



Rotor

max. RPM max. RCF	4,500 min ⁻¹ 3,305
max. capacity	8x50 ml
run-up run-down, braked in sec	17 14
angle	45°
temperature in °C ¹⁾	-11
Cat. No.	1721

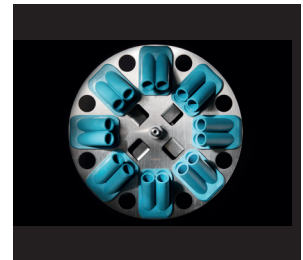

Vessels

capacity in ml	5	15	1.1–1.4	2.6–3.4	2.7–3	9–10	1.6–5	4–7	8.5–10	12	15	50	12	50	50
Ø x L in mm	12x75	17x100	8x66	13x65	11x66	16x92	13x75	13x100	16x100	17x102	17x120	29x115	17x100	29x115	29x107
max. RCF ²⁾	2,762	3,215	2,762	2,762	2,762	3,215	2,762	3,305	3,215	3,215	3,283	3,147	3,215	3,147	3,147
radius in mm	122	142	122	122	122	142	122	146	142	142	145	139	142	139	139
Cat. No.	tubes²⁾		blood collection tubes / urine tubes						tubes with screw cap						



Carrier

boring Ø x L in mm	17.4x91	17.4x91	17.4x91	17.4x91	17.4x91	17.4x91	17.4x91	17.4x91	17.4x91	17.4x91	17.4x91	30.2x92	17.4x91	30.2x92	30.2x92
vessels per rotor	32	32	32	32	32	32	32	32	32	32	32	8	32	8	8
Cat. No.	1467	1467	1467	1467	1467	1467	1467	1467	1467	1467	1467	1468	1467	1468	1468

1) For cooled versions: Lowest temperature achievable with precooling and max. speed.

2) Please note that the RCF values indicated refer only to rotor performance. The max. permissible RCF of tubes used should be verified with the individual manufacturers. The max. RCF for glass tubes annotated with footnote 2) is 4,000.

5) Tested by the TÜV in conformity with DIN EN 61010, section 2 - 020.

7) For centrifugation at high speeds, we recommend to use form-fitting, phenol-resistant adapters. Cat. No. 2031.

17) Packaging unit 15 pieces.

CERTIFICATIONS / REGISTRATIONS

Product certification:



Product registration:



Company certifications:



DOWNLOADS

[↓ Operating manual – ROTINA 380 | 380 R](#)

[↓ Complete Range Catalogue](#)

DIMENSIONS

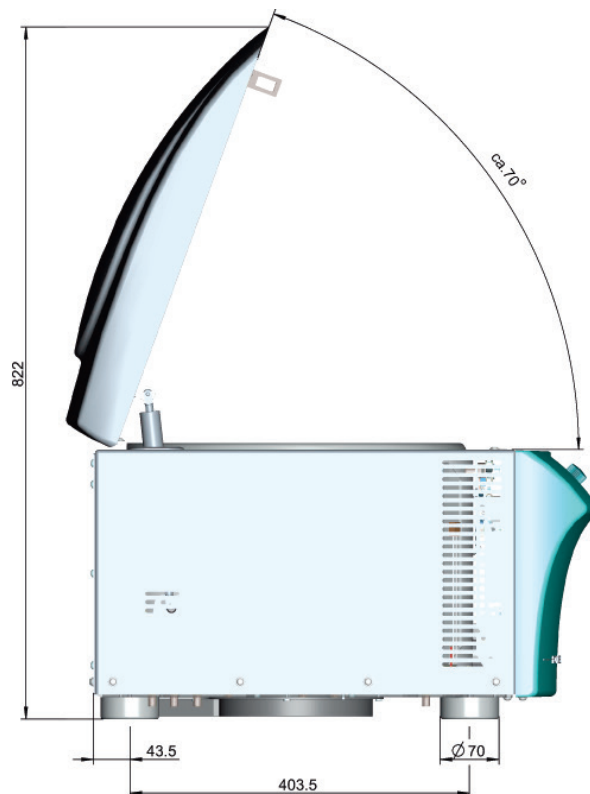
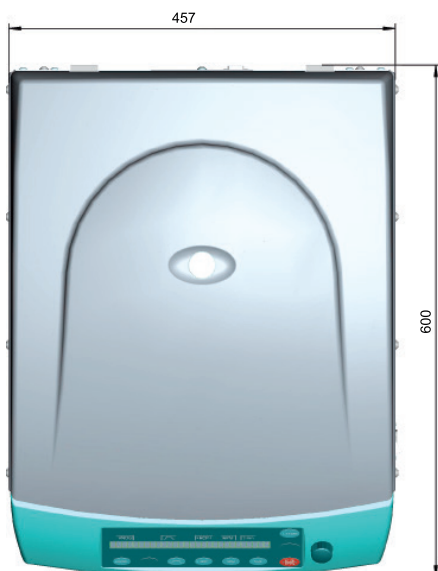

DIMENSIONS

