

Syringe Selection Guide

Complete Guide to Selecting the Right Hamilton Microliter,[™] Gastight,[®] and Specialty Syringes for Your Application

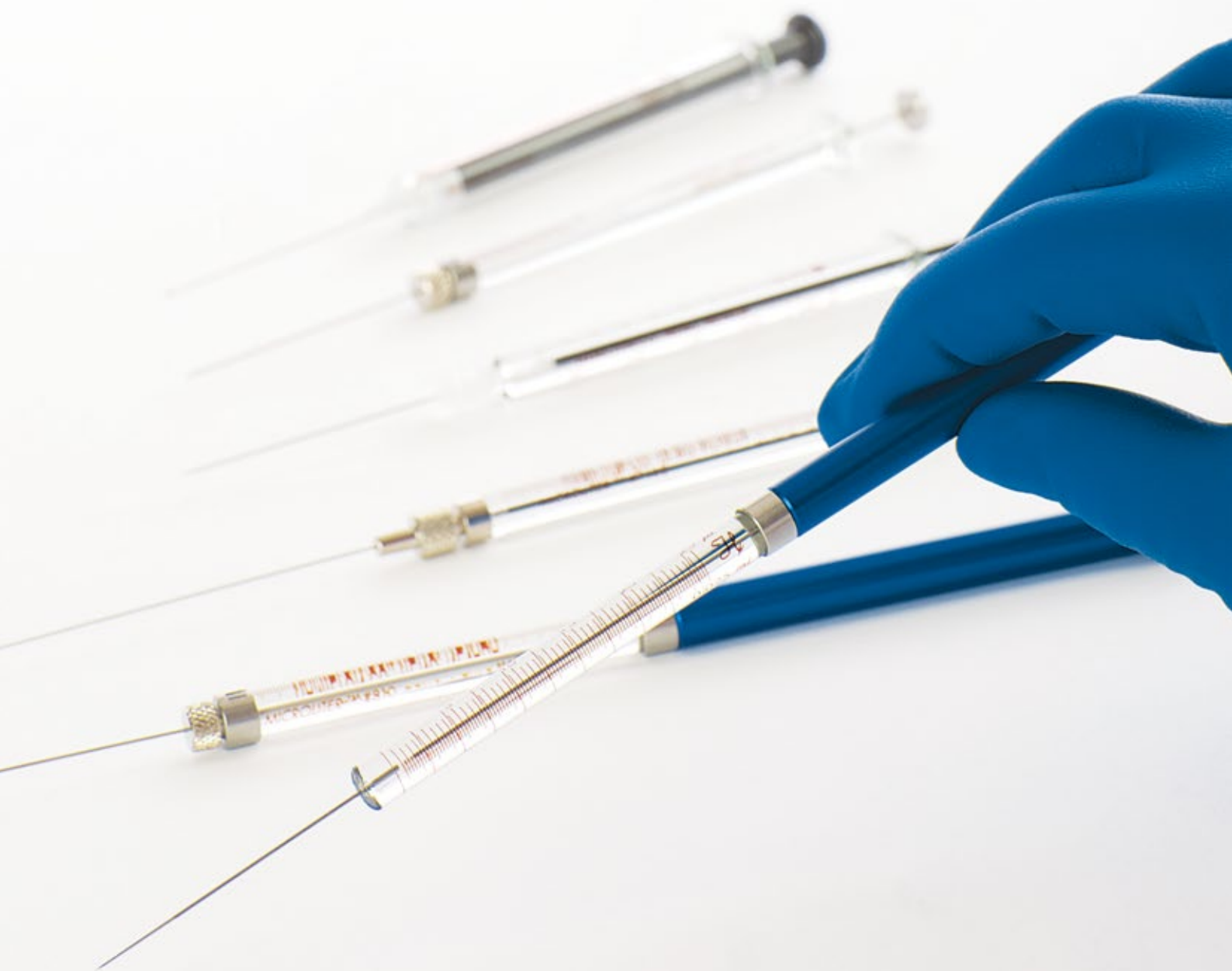

Table of Contents

Introduction	4
Syringe Schematics	5
Selecting the Right Syringe for Your Application Step-by-Step Guide	5
Hamilton Syringe Selection Worksheet	6
Example of Completed Worksheet	7
1. Syringe Types	8
Microliter Syringes For Liquids.....	8
Gastight Syringes For Liquids and Gases	8
2. Syringe Series	9
3. Series Descriptions	10
Microliter Syringes	10
600 Series (0.25 μ L — 5 μ L Delivery Volume)	10
700 Series (0.5 μ L – 500 μ L Delivery Volume)	10
Modified Microliter Syringes	11
800 Series (0.5 μ L — 250 μ L Delivery Volume)	11
7000 Series (0.05 μ L – 5 μ L Delivery Volume)	11
Gastight Syringes	12
1000 Series (100 μ L — 100 mL Delivery Volume)	12
1700 Series (1 μ L – 500 μ L Delivery Volume)	12
Super Syringes — Specialty Syringes for Gases	13
1800 Series (1 μ L – 250 μ L Delivery Volume)	13
Super Syringe (50 mL – 2L Delivery Volume)	13
4. Terminations	14
Cemented Needle (N)	14
Special Cemented Needle (SN)	14
Luer Tip Cemented Needle (LTN)	14
Luer Tip Special Cemented Needle (LTSN).....	14
Luer Tip (LT).....	15
Removable Needle (RN).....	15
Knurled Hub (KH)	15
PTFE Luer Lock (TLL)	15
SampleLock™ (SL).....	15



5. Needle Selection	16
Standard Needles	16
Custom Needles	16
Selecting a Needle Hub	16
Selecting a Needle Gauge	16
Selecting a Needle Point Style	17
Custom Needle Hubs	17
Point Styles and Applications	18
Needle Point Style Chart	18
Custom Needle Gauge and Length	18
Gauge Index Table	19
Accessories, Replacement Parts, and Services	20
Additional Technical Information	22
Technical Support	23

Introduction

Hamilton syringes are the finest quality precision fluid measuring devices available. Top quality materials and skilled workmanship ensure Hamilton syringes consistently deliver the highest possible performance for reliable analyses. With proper care and handling, Hamilton syringes provide unsurpassed performance year after year.

This guide presents all the information needed to select the right syringe for your manual application. In addition, Hamilton offers a complete line of syringes for use with instrumentation such as autosamplers and syringe pumps, including replacement syringes for pumps produced by other manufacturers. Top quality materials and skilled workmanship ensure that Hamilton syringes consistently deliver the highest possible performance for reliable analyses.

For manual dispenses, our syringes are accurate to within $\pm 1\%$ of nominal volume with a precision of 1% at 80% of the total volume. The fluid path of a Hamilton syringe is designed to be chemically inert with stainless steel, borosilicate glass, and PTFE used for most syringes. N.I.S.T. traceable certification is available as an additional service for the majority of the syringes in our product line.

All Hamilton products are unconditionally guaranteed to be free of defects in materials and workmanship for one year (12 months) from date of purchase. Hamilton Company is ISO 9001 Certified. Consult our published specifications to determine the material compatibility of Hamilton products with your application.

Hamilton continuously researches new materials and methods to improve the form, fit, and function of our syringes. You can be confident that when you buy from Hamilton you are receiving a top-quality instrument. For the latest information on new products, detailed product and part descriptions, published specifications, and our *Syringe Care and Use Guide*, please visit www.hamiltoncompany.com.

Syringes and needles manufactured by Hamilton Company are intended for scientific research and laboratory use only and are not intended for human *in vivo* use.



Syringe Schematics

Examples of Hamilton Microliter and Gastight Precision Syringes

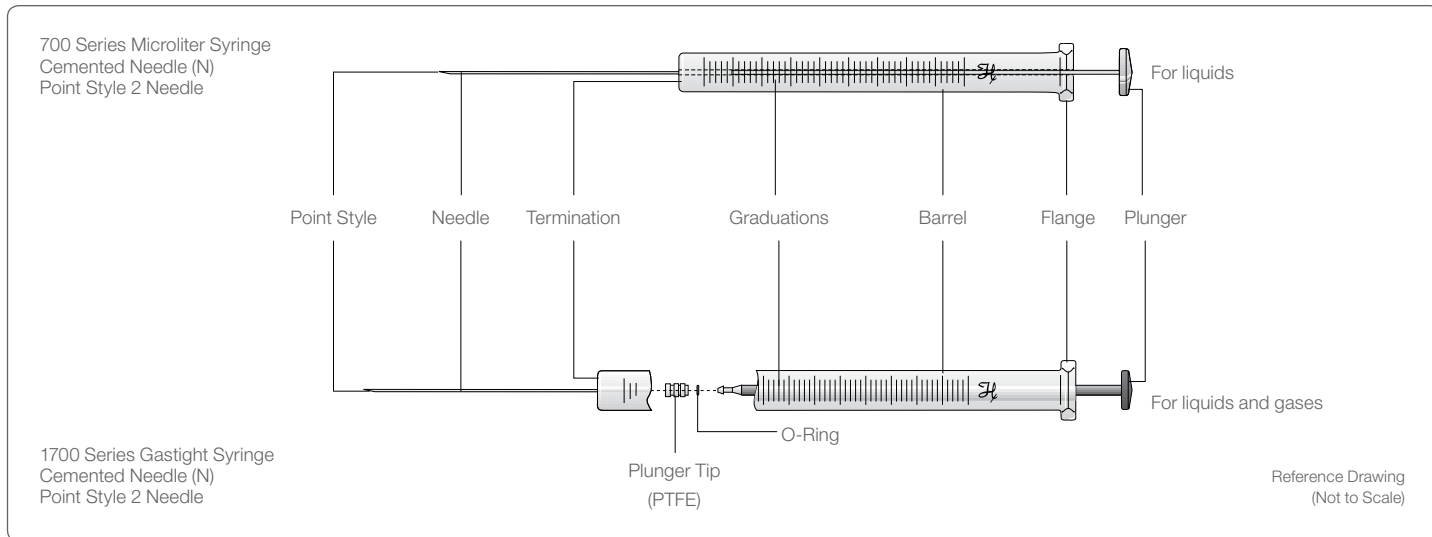

Microliter syringes have a stainless steel plunger which is individually hand-fitted to its matching glass barrel. The hand-fitting process is finely controlled to create a liquid-tight seal between the barrel and the plunger. Plungers for Microliter syringes cannot be interchanged or replaced if damaged.

Gastight syringes have a precision machined PTFE plunger tip which provides a tight seal for both liquids and gases. Replacement plunger assemblies are available for most Gastight syringes.

Selecting the Right Syringe for Your Application Step-by-Step Guide

Hamilton offers six core series with a wide range of delivery volumes, termination types, needle gauges, and needle point styles plus numerous speciality syringes. Hamilton’s syringe series are grouped by sample type, application, and volume range. Our syringes are further supported by an array of accessories that improve durability and reproducibility.

Use our five-step guide and worksheet to choose the ideal syringe for your application. The next page is a blank Hamilton Syringe Selection Worksheet. The blank

worksheet is followed by a sample of a completed worksheet. Instructions for using the worksheet are included on the form. Once the worksheet is completed, you can fully describe the syringe needed for your application.

NOTE: You may want to make copies of the blank worksheet for future use.

Hamilton Syringe Selection Worksheet

To use this worksheet, define the sample type and required dispensing volume. For additional details on any of the items, go to the appropriate reference section in this guide. Choose the feature needed and enter your selection on the worksheet. The completed worksheet fully describes

the Hamilton syringe needed for your application. Visit www.hamiltoncompany.com to identify the part number using the syringe selection tool or Hamilton Customer Service, the numbers are listed on the back of this guide.

Steps to Choosing a Syringe

1. See *Syringe Types, page 8*, to decide whether a Microliter or Gastight syringe is best for the application.

NOTE: Gastight syringes are recommended for viscous samples. With Microliter syringes, it is possible for air to slip past a plunger as a vacuum is created.

2. Use the *Syringe to Series Chart, page 9*, to determine the available syringe series in the volume range needed.
3. See the *Series Descriptions, starting on page 10*, to determine the most appropriate series, and the available volumes and terminations for that series.
4. See *Terminations, starting on page 14*, to determine the most suitable termination.
5. See *Needle Selection, page 16*, to determine the most appropriate needle if a termination or application requires the selection of a specific needle.
 - a. **Standard Needles.** Most Hamilton syringes are available with 51 mm (2 inches) needles of an appropriate gauge with either Point Style 2 (sharp point) or Point Style 3 (blunt point).
 - b. **Custom Needles.** If the application requires a non-standard length, gauge or point style, then Hamilton offers several custom options. See *Custom Needles, page 16*, to determine the appropriate needle for any application.

Your Selection

1. Microliter _____
 Gastight _____
 Your dispensing volume in μL _____
2. Series available _____

3. Series selected _____
 Volume selected _____
 Terminations available _____

4. Terminations selected _____
5. Standard Needle
 Point Style 2 _____
 Point Style 3 _____
 Custom Needle
 Gauge _____
 Length (mm or inches) _____
 Point Style _____
 Needle Hub _____

The right Hamilton syringe for my application is:

Type	Series	Volume	Termination	Needle
------	--------	--------	-------------	--------

Example of Completed Worksheet

In this example, Jane needs a syringe that is capable of doing nine rapid 10 μL injections of a blood serum solution for a nitric oxide study using GC analysis.

Steps to Choosing a Syringe

1. See *Syringe Types, page 8*, to decide whether a Microliter or Gastight syringe is best for the application.

Jane's sample is a liquid, but it is viscous and contains numerous dissolved components that over time could cause a fitted plunger to freeze, so she elects to use a Gastight syringe.

2. Use the *Syringe to Series Chart, page 9*, to determine the available syringe series in the volume range needed.

Using the chart, she determines that syringes in the 1700 and 1800 series are available in her volume range.

3. See the *Series Descriptions, starting on page 10*, to determine the most appropriate series, and the available volumes and terminations for that series.

From the descriptions, she determines that although the 1700 series would work, the 1800 series has a supported plunger which eliminates the chance of bending the fragile plunger during the nine rapid injections. She selects the appropriate volume and lists the terminations available for the 1800 series syringes.

4. See *Terminations, starting on page 14*, to determine the most suitable termination.

She sees that the 1800 series syringes are available with either Cemented Needle or Removable Needle terminations. She determines that a Removable Needle is the most appropriate termination because if her serum sample clogs the needle she can replace the needle and not the whole syringe.

5. See *Needle Selection, page 16*, to determine the most appropriate needle if a termination or application requires the selection of a specific needle.

Since a standard needle is suitable for her application, Jane does not need to supply information for a custom needle. She requires piercing a septum, for which point style 2 is appropriate.

Your Selection

1. Microliter _____

Gastight X _____

Your dispensing volume 10 μL _____

2. Series available 1700 and 1800 _____

3. Series selected 1800 _____

Volume selected 10 μL _____

Terminations available N and RN _____

4. Terminations selected RN _____

5. Standard Needle

Point Style 2 X _____

Point Style 3 _____

Custom Needle

Gauge _____

Length (mm or inches) _____

Point Style _____

Needle Hub _____

The right Hamilton syringe for my application is:

Gastight

1800

10 μL

RN

Point Style 2

Type

Series

Volume

Termination

Needle

Jane calls Hamilton Customer Service and orders a Gastight 1800 series 10 μL syringe with an RN hub and a standard sharp needle (Point Style 2).

1. Syringe Types

The key to selecting the right syringe for your application is to identify your sample type and determine the smallest volume to be dispensed or injected. Hamilton offers two types of syringes, Microliter and Gastight, which differ in the design of the plunger.

Microliter Syringes For Liquids

Microliter syringes incorporate a hand-fitted stainless steel plunger with a finely bored syringe barrel. These syringes are ideal for organic samples that are not prone to precipitation, crystallization or bonding with glass.

Under the proper conditions, plunger wear is minimal and the life of a Microliter syringe is almost unlimited. However, when using heterogeneous solutions with a Microliter syringe, the user must be especially diligent about cleaning the syringe after each use. For more information, see our *Syringe Care and Use Guide*.

In some cases, even diligent cleaning is not sufficient and the barrel will become soiled. The deposits on the glass will compromise the tight tolerances between the glass and the plunger resulting in a frozen plunger. Plungers for Microliter syringes cannot be interchanged or replaced if damaged. For aqueous and low volatile solutions, a Gastight syringe is the best option.

Gastight Syringes For Liquids and Gases

Gastight syringes have a precision-machined polymer plunger tip, often PTFE, which creates a leak-free seal. With the tight fit, the tip essentially wipes the interior of the syringe barrel free of sample. This feature is particularly useful with aqueous and low volatile organic samples because it reduces the chance that a deposit will occur and cause the plunger to freeze.

The Gastight series still requires careful and regular cleaning to minimize deposits on the glass which might score the soft PTFE plunger tip and result in a leak. Replacement plunger assemblies are available for Gastight syringes. However, a replacement plunger should not be put into a barrel that still contains deposits because the new plunger tip is likely to be scored by the deposit after only a few strokes. It is important to remember that over time, the increased friction created by the tight seal may cause the PTFE tip to wear out and the plunger will have to be replaced.



2. Syringe Series

For organic liquid samples, there are four Microliter syringe series. For gas samples and aqueous or low volatile liquids, there are four Gastight syringe series from which to choose. Given the variety of syringe series available with Microliter and Gastight plungers, an easy way to narrow down the list of series is to use delivery (or dispensing) volume as a discriminating factor. For the most accurate dispenses always choose a syringe that has a nominal volume as close to the dispense volume as possible.

For accuracy and precision, the smallest dispensing volume for a given syringe should be greater than or equal to 10% of its total capacity. For example, the smallest dispensing volume recommended for a 10 μL syringe is 1 μL . The following Syringe Type to Series Chart shows the volumes that each series is capable of dispensing within 10 – 100% of the syringes' nominal volume.

The Hamilton Syringe Type to Series Chart

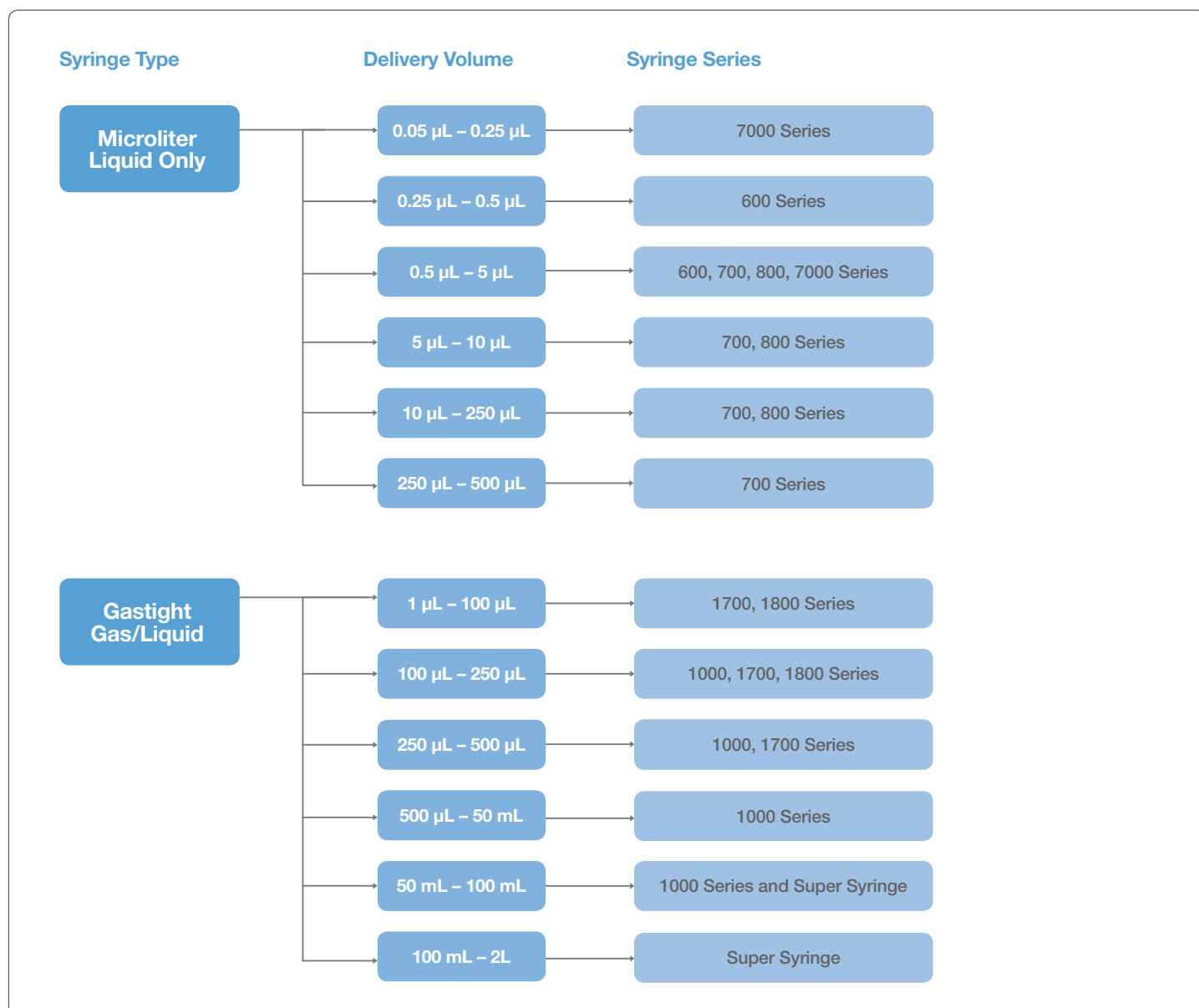

3. Series Descriptions

Complete descriptions for Hamilton syringe series used for manual applications are given below. The descriptions include product features and typical applications along with the volumes, terminations, and accessories available for each series. For some volumes, several series may include syringes with equivalent volume ranges and similar terminations.

Microliter Syringes

(0.05 μL – 500 μL Delivery Volume)

This type of syringe is for use with liquids and incorporates a stainless steel plunger that is individually fitted to its matching syringe barrel. These micro-volume syringes have a very close tolerance between the plunger and the barrel which creates a liquid-tight seal without parts such as o-rings that eventually wear out.

600 Series (0.25 μL – 5 μL Delivery Volume)

The 600 series are robust syringes consisting of two distinct parts. The bottom half of the barrel accurately measures the liquid sample and the top half supports the plunger. In addition, the top section of the plunger is thicker to further reduce the risk of bending the plunger. These syringes require half of the standard stroke length making them ideal for one-handed operation. The plungers and barrels are not interchangeable or replaceable.

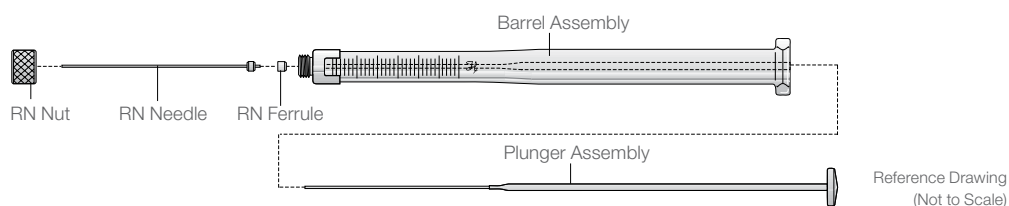

Recommended Use:

The 600 series is great for animal injections because one hand is free for manipulating the animal.

Volumes:

2.5 μL and 5 μL

Terminations:

Removable Needle (RN)

Accessories:

Syringe Guide and Reproducibility Adapter

700 Series (0.5 μL – 500 μL Delivery Volume)

The 700 series is the original Hamilton syringe. It was designed to solve the general liquid handling requirements of manufacturing and research laboratories and remains the industry standard. The plungers and barrels are not interchangeable or replaceable.

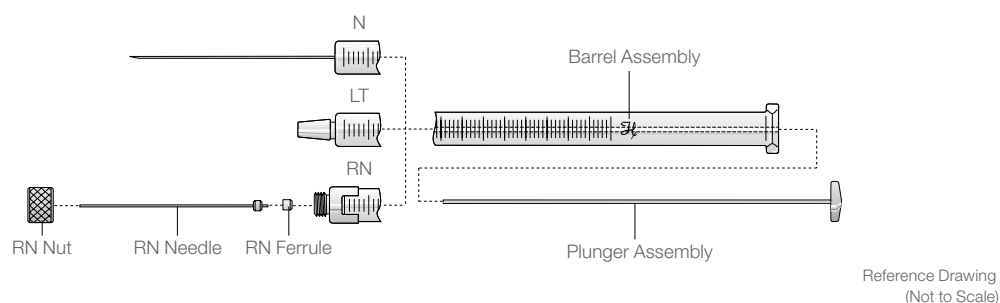

Recommended Use:

The 700 series is used for manual and automated GC and HPLC injections. Also, it is used for everyday applications that require accurate measuring and dispensing of liquid.

Volumes:

5 μL , 10 μL , 25 μL , 50 μL , 100 μL , 250 μL , and 500 μL

Terminations:

Cemented Needle (N), Special Cemented Needle (SN), Removable Needle (RN), and Luer Tip (LT)

Accessories:

PB600-1 Repeating Dispenser, Reproducibility Adapter, Syringe Guide, and Digital Syringe



800 Series (0.5 µL – 250 µL Delivery Volume)

The 800 series has the same liquid handling capabilities as the 700 series but with the addition of an aluminum syringe holder designed to eliminate plunger damage. The syringe holder screws onto the glass barrel. A two-piece extended plunger further eliminates the risk of breakage. A friction screw at the top of the barrel can be adjusted to give the user some control over dispensing speed and prevent the accidental removal of the plunger. In addition, the syringe holder can be fitted with different barrel/plunger assemblies to cover a range of volumes.

Recommended Use:

This syringe is intended for applications where the plunger on a 700 series syringe might be bent. Excellent for novice users.

Volumes:

5 µL, 10 µL, 25 µL, 50 µL, 100 µL, and 250 µL

Terminations:

Cemented Needle (N) and Removable Needle (RN)

Accessories:

Reproducibility Adapter

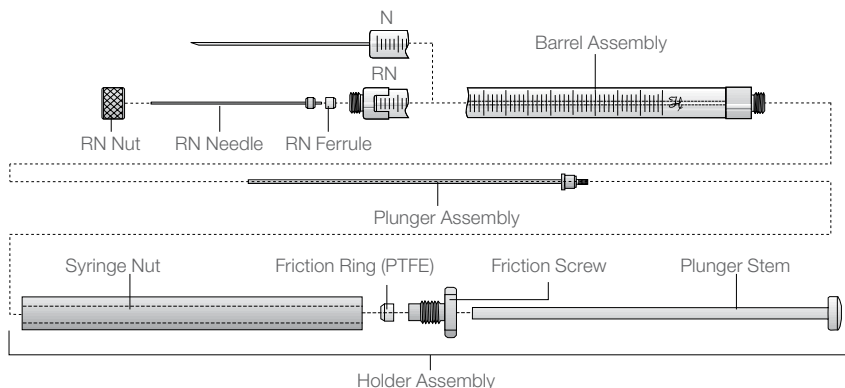

Reference Drawing (Not to Scale)

Modified Microliter Syringes

7000 Series (0.05 µL – 5 µL Delivery Volume)

The 7000 series employs a plunger wire inside the needle to accurately dispense ultra-low volumes. The needle is bored to extremely accurate tolerances to accommodate the plunger wire. With the plunger inside the needle, the standard dead volume inside the needle is eliminated.

Recommended Use:

The 7000 series is used for manual and automated GC and HPLC injections. Also, it is used for everyday applications that require ultra-small measurements of liquid.

Volumes:

0.5 µL, 1 µL, 2 µL, and 5 µL

Terminations:

Knurled Hub (KH)

Accessories:

Reproducibility Adapter, Syringe Guide, Digital Syringe, and Syringe Cleaner

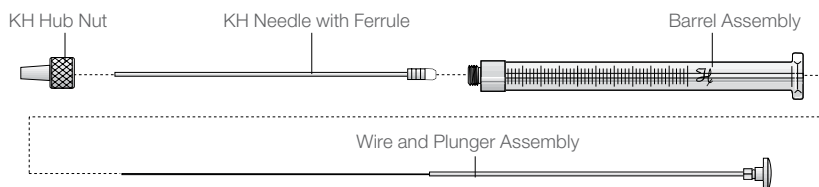

Reference Drawing (Not to Scale)

Gastight Syringes

(1 μL – 100 mL Delivery Volume)

These syringes can be used with both liquids and gases. The precision-machined PTFE plunger tip creates a leak-free seal. The plungers are replaceable.

1000 Series (100 μL – 100 mL Delivery Volume)

The 1000 series is a mid-volume solution for all liquid and gas handling needs.

Recommended Use:

The 1000 series is ideal for manual and automated HPLC injections. This syringe is commonly used in syringe pumps and other liquid handling instrumentation.

Volumes:

1 mL, 1.25 mL, 2.5 mL, 5 mL, 10 mL, 25 mL, 50 mL, and 100 mL

Terminations:

Luer Tip Cemented Needle (LTN), Luer Tip Special Cemented Needle (LTSN), Luer Tip (LT), Removable Needle (RN), PTFE Luer Lock (TLL), and SampleLock (SL)

Accessories:

PB600-1 Repeating Dispenser for volumes (1 to 2.5 mL)

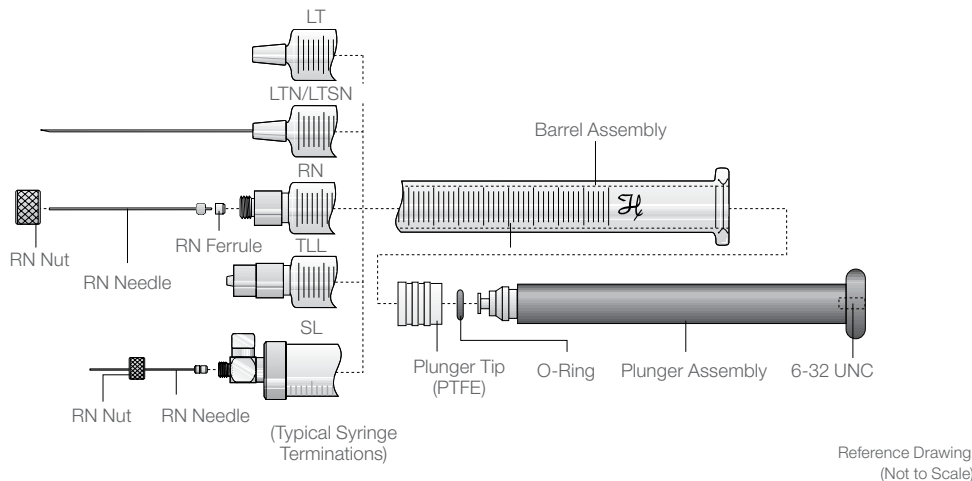

1700 Series (1 μL – 500 μL Delivery Volume)

This is the Gastight version of the original Hamilton 700 series syringe. It was designed to meet the low volume liquid or gas handling needs of research and manufacturing laboratories.

Recommended Use:

The 1700 series is excellent for manual and automated GC and HPLC injections. This syringe is commonly used in syringe pumps and other liquid handling instrumentation.

Volumes: 10 μL , 25 μL , 50 μL , 100 μL , 250 μL , and 500 μL

Terminations:

Cemented Needle (N), Special Cemented Needle (SN), Luer Tip Cemented Needle (LTN), Luer Tip Special Cemented Needle (LTSN), Luer Tip (LT), Removable Needle (RN), PTFE Luer Lock (TLL), and SampleLock (SL)

Accessories:

PB600-1 Repeating Dispenser, Reproducibility Adapter, Syringe Guide, and Digital Syringe

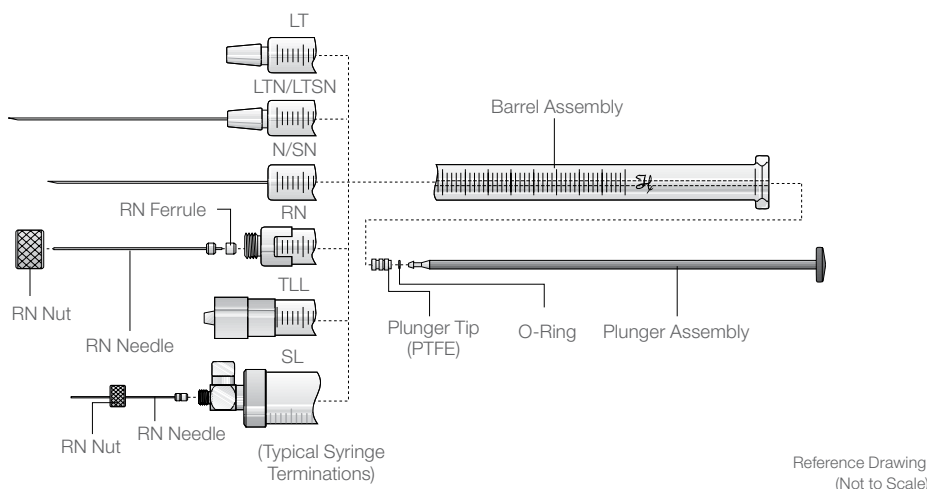

1800 Series (1 µL – 250 µL Delivery Volume)

The 1800 series was designed to eliminate the possibility of plunger damage. It has the same liquid handling capabilities as the 1700 series but the extended plunger eliminates breakage and allows the user some control over the dispense speed.

Recommended Use:

This syringe is intended for applications where the plunger on a 1700 series syringe might be bent.

Volumes:

10 µL, 25 µL, 50 µL, 100 µL, and 250 µL

Terminations:

Cemented Needle (N) and Removable Needle (RN)

Accessories:

Reproducibility Adapter

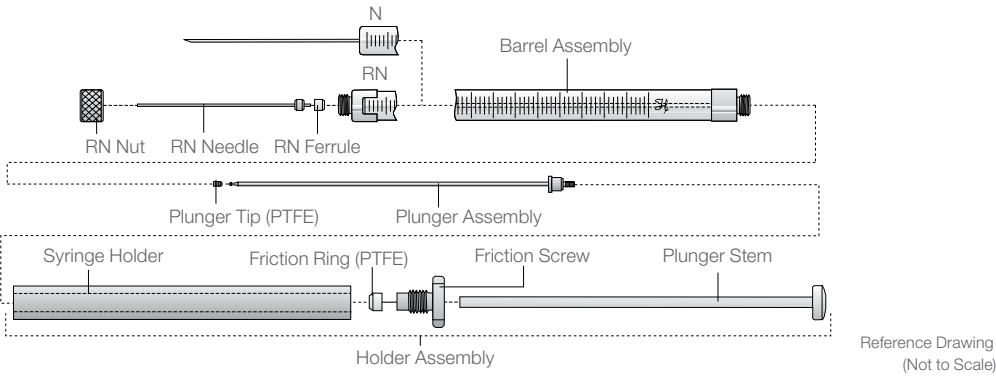

Super Syringes — Specialty Syringes for Gases

Super Syringe (50 mL – 2L Delivery Volume)

Super Syringes were designed primarily for air sampling, preparing gas standards, calibrating reservoirs and pneumographs. The Super Syringe is the only Hamilton syringe with an acrylic barrel, which makes this syringe slightly less chemically resistant.

Recommended Use:

This syringe is intended for sampling or transfer of gases.

Volumes:

0.5 L, 1 L, 1.5 L, and 2 L

Terminations:

PTFE Luer Lock (TLL) and Tracheal Adapter (accepts 5/8 inch I.D. flexible tubing)

Accessories:

None

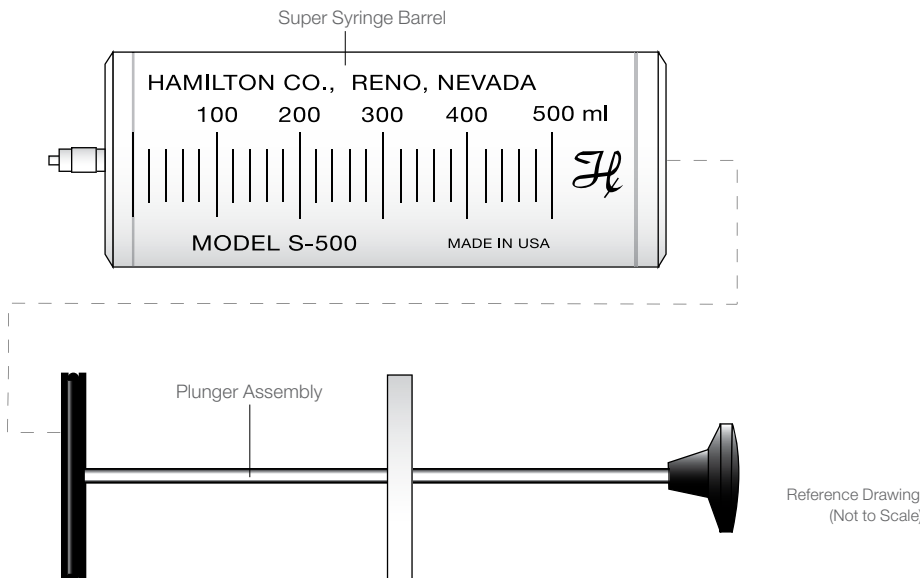

4. Terminations

Terminations are located at the end of the syringe barrel and function as the interface between the syringe and its mating connection such as the needle. Terminations are offered in a number of different needle and connection configurations to accommodate a broad range of applications. Below is a listing of the most popular syringe terminations. For a complete overview, please visit www.hamiltoncompany.com.

Cemented Needle (N)

For low volume syringes

The needles are cemented into the glass syringe barrel at a point corresponding to the zero graduation mark. With this termination, dead volume is limited to the internal volume of the needle. Not autoclavable. Needle gauge is determined by the syringe volume and are not user-selectable. For available needle gauges, visit www.hamiltoncompany.com.



Special Cemented Needle (SN)

For low volume syringes

The special needle terminations are the same as the Cemented Needle terminations except they allow for a variety of user-defined gauges, lengths, and point styles to be attached.



Luer Tip Cemented Needle (LTN)

For mid volume syringes

The needles are cemented into the glass syringe barrel at a point corresponding to the zero graduation mark. With this termination, dead volume is limited to the internal volume of the needle. Not autoclavable. Needle gauge is determined by the syringe volume and are not user-selectable. For available needle gauges, see www.hamiltoncompany.com.



Luer Tip Special Cemented Needle (LTSN)

For low volume syringes

The special needle terminations are the same as the Luer Tip Cemented Needle terminations except they allow for a variety of user-defined gauges, lengths, and point styles to be attached.



Luer Tip (LT)

The needles are removable and fit over a ground glass hub which is tapered in the shape of a male Luer. This Luer tip is manufactured to the ANSI standard for Luer connections. The LT termination will accept most hypodermic needles but was designed specifically for use with Hamilton Kel-F needles. This termination increases the dead volume in the syringe, which may not be appropriate for some applications. Autoclavable when disassembled.



Removable Needle (RN)

The needles are removable and are a Hamilton-specific design. The design allows the needles to seat precisely at the zero graduation mark of the syringe. Users can select the needle gauge, length and point style to optimize the syringe for custom applications. Additionally, this termination allows for a removable needle without increasing the dead volume of the syringe and is ideal when there is a risk of the needle clogging. Autoclavable when disassembled. Repeated autoclaving will shorten syringe life. For more information, see our *Syringe Care and Use Guide*.

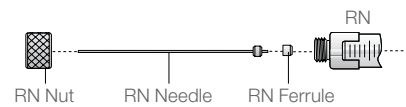

Knurled Hub (KH)

The knurled hub is used exclusively on 7000 Series syringes. The hub handles up to 6000 psig maximum injection pressure. The needle is removable but with a limited number of gauges available because the plunger is fitted inside the needle. Autoclavable when disassembled. Repeated autoclaving will shorten syringe life. For more information, see our *Syringe Care and Use Guide*.

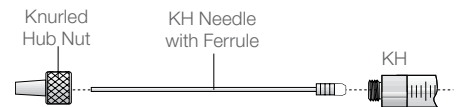

PTFE Luer Lock (TLL)

This termination has a PTFE, male Luer taper with nickel-plated brass locking hub for use with Kel-F needles, metal hub needles and universal connectors. Also, the TLL is used with Hamilton diluters/dispensers, liquid handling applications, and manual operations. Autoclavable when disassembled, except on 25 mL and greater syringes. Repeated autoclaving will shorten syringe life. For more information, see our *Syringe Care and Use Guide*.



SampleLock™ (SL)

The sample lock incorporates an on/off syringe valve with RN needle. This termination is used for headspace, environmental sample collection and storage, pre-pressurization of gaseous samples for GC analysis and sample spiking. Not autoclavable.

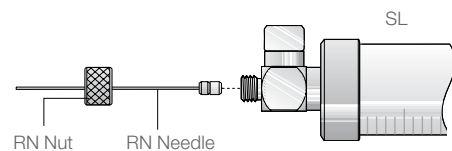

Reference Drawing (Not to Scale)

5. Needle Selection

Needle point styles range from blunt points for HPLC injections to conical points for penetrating vinyl and plastics. With most syringes, Hamilton provides a standard 51 mm (2 inches) needle of an appropriate gauge and point style. However, if your project requires a non-standard needle gauge or point style, Hamilton offers a wide variety of custom options.

Standard Needles

Many Hamilton syringes come with a preselected needle that is installed into the syringe. The default gauge (22 or 26), length (51 mm), and point style (2 or 3) is selected to provide optimum performance from each syringe. For example a 10 μ L syringe uses a 26s gauge needle. The 's' gauge tubing has a small inner diameter and a low dead volume which can be easily primed by the small 10 μ L syringe. By contrast a 10 mL syringe uses a 22 gauge needle which has a larger inner diameter allowing faster flow from the larger syringe. Throughout our website and catalogs, the needles are designated by gauge, length (mm), and point style in this format (22s/51/2). Review the Needle Point Style Chart to determine if a standard point style is suitable or if a custom needle is necessary for your application.

Custom Needles

For our custom needles, the user-defined parameters are indicated by asterisk like (22s/**). Review the following sections to fully define the custom needle that is required. There are limits to the gauge, length, and point style combinations that are available so contact Hamilton Technical Support or your local dealer for assistance. Below are some general rules to keep in mind when selecting a needle hub, gauge, length, and point style.

Selecting a Needle Hub

The chart to the right shows the available needle hubs that allow for customization. The Metal and Kel-f Luer Lock hubs are an industry standard connection that accommodates a wide range of needle gauges. For syringes 250 μ L and above this is a good option. However, for syringes smaller than 250 μ L the dead volume in the Luer lock connector can trap air and make it more difficult to prime. For these small syringes a Removable Needle or Cemented Needle connection may be a better choice.

Selecting a Needle Gauge

Selecting the proper needle gauge is dependent on the application but the gauge index on page 19 and the following general guidelines should be considered:

- If the application requires septum penetrations do not choose a gauge smaller than 26 gauge or there will be an increased risk of bending the needle. Also avoid needles larger than 22 gauge to avoid coring the septum resulting in a clogged needle.
- When choosing a needle gauge to connect to a small syringe it is critical to take into account the needle's dead volume which is listed in μ L/inch in the gauge index. Selecting a needle with too large of a dead volume could make the syringe difficult to prime.
- When the sample to be dispensed is viscous a small gauge needle (27 – 34) can make it difficult to aspirate sample into the syringe. If a small gauge needle is required it may be necessary to backfill the syringe. Additionally, slower rates may be required so the syringe is not over pressurized.



Selecting a Needle Point Style

Review the list of needle point styles on page 18 to select the best option for the application.

Custom Needle Hubs

Choose a needle hub based on the syringe volume and the compatible termination for the specific syringe you have selected for your application.

Special Cemented Needle (SN): These Cemented Needle syringes allow for user-defined needles to be attached from the factory.

Luer Tip Special Needle (LTSN): These Luer Tip Cemented Needles allow for user-defined needles to be attached from the factory.

Metal Hub Luer Lock Needle (N): These needles are designed for use with the TLL syringe termination and are available in a variety of gauges between 33 and 10.

Kel-F Hub Luer Lock Needle (KF): These needles are designed for use with the LT and TLL syringe terminations and are available in a variety of gauges between 31 and 10.

Small Hub Removable Needle: These needles are designed for use with the RN syringe termination on syringes with a nominal volume less than or equal to 100 μL . The needles are available in a variety of gauges between 34 and 18. Note: Remove the original needle and PTFE ferrule from the RN termination before inserting the replacement needle assembly.

Large Hub Removable Needle: These needles are designed for use with the RN syringe termination on syringes with a nominal volume greater than or equal to 250 μL . The needles are available in a variety of gauges between 26s and 20. Note: Remove the original needle and PTFE ferrule from the RN termination before inserting the replacement needle assembly.

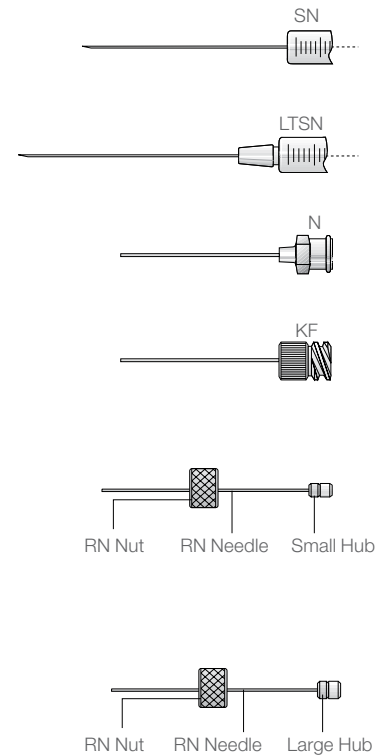

NOTE: For assembly instructions for N, KF and RN needles, refer to our *Syringe and Needle Assembly Guide* in the downloads section of our website.

Point Styles and Applications

The correct point style varies depending on the intended application. Below are a few examples of common applications.

GC Injections: Historically a point style 2 was required to achieve efficient septum penetration with minimized coring. With Hamilton's GC septa there is evidence that indicates the point style AS will consistently extend septa life by as much as 10-fold.





HPLC Injections: Most HPLC injection valves are designed to be used with a 22 gauge point style 3 needle.

Animal Injections: Point style 4, the bevel degree can be changed from 12 – 60° allows for the most accurate targeting of a specific biological structure.

GC and GC Headspace Injections: Point style 5 allows for penetration of septa while eliminating coring by featuring a side port hole in the needle.

Autosampler Injections: Point style AS allows for repeated autosampler injections while maintaining needle integrity.

Needle Point Style Chart

Point Style 2		Sharp, beveled, curved, non-coring needle point recommended for septum penetration. Available gauges: 34 – 10.
Point Style 3		Blunt needle point for use with HPLC injection valves and for sample pipetting. Available gauges: 34 – 10.
Point Style 4		Standard 12° beveled needle point is recommended for life science applications. Available gauges: 34 – 10. Special point styles such as 30°, 45°, or any other angle are available upon request.
Point Style 5		Conical needle with side port for penetration of septa, thin-gauged vinyls and plastics without coring. Available gauges: 26s – 10.
Point Style AS		Special conical style needle point used on autosampler syringes the non-coring needle point is recommended for septum penetration. Available gauges: 26s – 10.

Custom Needle Gauge and Length

When selecting a needle gauge it is important to keep in mind the volume of the syringe and the dead volume of the needle. For example, it will be very difficult to prime a 10 µL syringe if the dead volume in the needle is greater than 10 µL. Refer to the gauge index to choose a needle gauge with an appropriate µL/inch before selecting a needle. Select the minimum length that allows you to carry out your application comfortably.

The 's' on a 22s needle represents a smaller inner diameter (I.D.) for the needle and a thicker needle wall for better durability. For example, a 26 gauge needle has an outer diameter (O.D.) of 0.46 mm and an I.D. of 0.26 mm while the 26s gauge needle has an O.D. of 0.47 mm and an I.D. of 0.13 mm. The 26s has half the I.D. of the 26 gauge needle. Also, the difference in the wall thickness nearly doubles with 26s gauge having a thickness of 0.35 mm while the 26 gauge is only 0.20 mm.



Gauge Index Table

Gauge	Nominal O.D.		Nominal I.D.		Wall Thickness		Volume μL/Inch
	Inch	mm*	Inch	mm*	Inch	mm*	
34	0.0060 – 0.0065	0.159	0.0015 – 0.0025	0.051	0.004	0.11	0.052
33	0.0080 – 0.0085	0.210	0.0035 – 0.0050	0.108	0.004	0.10	0.233
32	0.0090 – 0.0095	0.235	0.0035 – 0.0050	0.108	0.005	0.13	0.233
31	0.0100 – 0.0105	0.261	0.0045 – 0.0060	0.133	0.005	0.13	0.353
30	0.0120 – 0.0125	0.312	0.0055 – 0.0070	0.159	0.006	0.15	0.504
29	0.0130 – 0.0135	0.337	0.0065 – 0.0080	0.184	0.006	0.15	0.675
28	0.0140 – 0.0145	0.362	0.0065 – 0.0080	0.184	0.007	0.18	0.675
27	0.0160 – 0.0165	0.413	0.0075 – 0.0090	0.210	0.008	0.20	0.876
26s	0.0184 – 0.0189	0.474	0.0045 – 0.0055	0.127	0.014	0.35	0.322
26	0.0180 – 0.0185	0.464	0.0095 – 0.0110	0.260	0.008	0.20	1.349
25s	0.0200 – 0.0205	0.515	0.0055 – 0.0065	0.153	0.014	0.36	0.464
25	0.0200 – 0.0205	0.515	0.0095 – 0.0110	0.260	0.010	0.25	1.349
24	0.0220 – 0.0225	0.566	0.0115 – 0.0130	0.311	0.010	0.25	1.930
23s	0.0250 – 0.0255	0.642	0.0040 – 0.0051	0.116	0.021	0.53	0.268
23	0.0250 – 0.0255	0.642	0.0125 – 0.0140	0.337	0.012	0.30	2.266
22s	0.0280 – 0.0285	0.718	0.0055 – 0.0077	0.168	0.022	0.55	0.563
22	0.0280 – 0.0285	0.718	0.0155 – 0.0170	0.413	0.012	0.30	3.403
21	0.0320 – 0.0325	0.819	0.0195 – 0.0210	0.514	0.012	0.30	5.271
20	0.0355 – 0.0360	0.908	0.0230 – 0.0245	0.603	0.012	0.30	7.255
19	0.0415 – 0.0425	1.067	0.0255 – 0.0285	0.686	0.015	0.38	9.389
18	0.0495 – 0.0505	1.270	0.0315 – 0.0345	0.838	0.017	0.43	14.011
17	0.0575 – 0.0585	1.473	0.0405 – 0.0435	1.067	0.016	0.41	22.715
16	0.0645 – 0.0655	1.651	0.0455 – 0.0485	1.194	0.018	0.46	28.444
15	0.0715 – 0.0725	1.829	0.0525 – 0.0555	1.372	0.018	0.46	37.529
14	0.0820 – 0.0840	2.109	0.0610 – 0.0650	1.600	0.020	0.51	51.076
13	0.0940 – 0.0960	2.413	0.0690 – 0.0730	1.804	0.024	0.61	64.895
12	0.1080 – 0.110	2.769	0.0830 – 0.0870	2.159	0.024	0.61	93.000
11	0.1190 – 0.1210	3.048	0.0920 – 0.0960	2.388	0.026	0.66	113.728
10	0.1330 – 0.1350	3.404	0.1040 – 0.1080	2.693	0.028	0.71	144.641

* mm are nominal

Accessories, Replacement Parts, and Services

Hamilton offers a variety of accessories to improve durability and reproducibility, including the ones described below, as well as replacement parts for our syringes. Details can be found at www.hamiltoncompany.com.

Cleaning Solution Concentrate

The concentrate is a biodegradable cleaning agent for removal of stubborn residues. Hamilton P/N 18311 (500 mL).



Needle Cleaning Kit

Contains a selection of various diameter tungsten wires as well as a biodegradable Cleaning Solution Concentrate for cleaning clogged needles. Hamilton P/N 76620A. Additional cleaning wires and Cleaning Solution Concentrate can be purchased separately.



Syringe Cleaner

The unit is designed to clean 7000 series Microliter syringes with only heat (370 °C) or add a vacuum source (0.1 mm mercury) to remove suspected residuals. Hamilton P/N 76610 (120 VAC) and P/N 76615 (220 VAC).



Syringe Guide

The guide is easily installed on a syringe to prevent the plunger from bending or being pulled out. Two models are offered for different syringe volumes and series. Hamilton P/N 14806 (5 – 10 µL) and 14906 (25 – 500 µL).



Reproducibility (Chaney) Adapter

The Chaney Adapter is easily installed on a syringe for consistent, reproducible injections. Also, the adapter prevents plunger bending while an adjustable stop provides increased accuracy and precision. Three models are available to accommodate a range of syringe volumes and series. Hamilton P/N 14700 (5 – 10 μL 700 and 1700 series), P/N 14725 (25 – 500 μL 700 and 1700 series), and P/N 32146 (5 – 250 μL 800 and 1800 series).



PB600-1 Repeating Dispenser

The PB600-1 Hamilton P/N 83700 can be used with liquids or gases to consistently dispense 1/50th of the syringe volume. The dispenser fits Microliter and Gastight syringes with volumes up to 2.5 mL.



Digital Syringe

The base unit can be used with Hamilton syringes in the 700, 1700, and 7000 series with nominal volumes between 0.5 μL and 500 μL . An easy-to-read LCD screen displays the volume contained in the syringe to within $\pm 0.5\%$ of the syringe nominal volume for syringes above 2 μL and $\pm 1\%$ of the syringe nominal volume for all 7000 series syringes. The Digital Syringe is ordered by adding 'DS' as a prefix to the required syringe part number.

Digital Syringes are automatically N.I.S.T. traceably calibrated to the base unit prior to shipment. Recalibration service is available for the Digital Syringe. Contact Hamilton Customer Service Department to obtain an RMA number (Returned Materials Authorization number). Include the syringe part number used with the base unit on the RMA and return the digital unit without the syringe. The customer will be charged the calibration fee plus the cost of a new syringe.



N.I.S.T. Traceable Certification

This calibration service is available for most of our precision syringes. A Certificate of Calibration is shipped with the product and the procedure is performed with an unbroken chain of calibration with N.I.S.T. traceable weights. Calibrated syringes must be specified at the time of ordering by adding the prefix 'CAL' to the beginning of the syringe's part number. For example, to order a 701N, 10 μL syringe Hamilton P/N 80300 as a calibrated syringe, request P/N CAL80300.



Additional Technical Information

The following information is available on our website and as PDFs.

Hamilton Precision Syringes Care and Use

With proper care and handling, Hamilton syringes will provide unsurpassed performance year after year. See our complete *Syringe Care and Use Guide*.

Determining the Performance of Hamilton Syringes

Follow the protocol on this document to confirm the accuracy of a syringe. The Hamilton Company Quality System is ISO 9001 certified.

Inner and Outer Dimensions

For applications and projects where the physical dimensions of a syringe are important, specifications are provided for the most popular syringes in our product line.

Product Instruction Sheets

Electronic versions of the documentation shipped with new products contains information on assembly, use, replacement parts, etc. Refer to these instruction sheets if you have misplaced an original instruction sheet or would like to see more information on a specific product prior to purchase.

Syringe Graduations

Hamilton provides information relating to the scale divisions on a syringe to the delivery volume. A series of tables detail this information for all of our syringes.

Technical Support

Hamilton Americas & Pacific Rim

Hamilton Company

4970 Energy Way
Reno, Nevada 89502

Customer Service

(888) 525-2123

Technical Support/Service

(800) 648-5950

Outside of the U.S.

+1 (775) 858-3000

Email: sales@hamiltoncompany.com

Hamilton Europe, Asia, & Africa

Hamilton Central Europe S.R.L.

str. Hamilton no. 2-4
307210 Giarmata, Romania

Customer Service

+40-356-635-050

Fax: +40-356-635-060

Email: contact.lab.ro@hamilton.ch

Frequently Asked Questions

Many of your questions can be answered by visiting the FAQ located in the Technical Information drop-down menu within the Syringes & Needles section of www.hamiltoncompany.com.



©2017 Hamilton Company. All rights reserved.
All other trademarks are owned and/or registered by Hamilton Company in the U.S. and/or other countries.
Lit. No. L20082 Rev. B— 05/2017

HAMILTON 

Web: www.hamiltoncompany.com

USA: 800-648-5950

Europe: +40-356-635-050

Hamilton Americas & Pacific Rim

Hamilton Company Inc.
4970 Energy Way
Reno, Nevada 89502 USA
Tel: +1-775-858-3000
Fax: +1-775-856-7259
sales@hamiltoncompany.com

Hamilton Europe, Asia, & Africa

Hamilton Central Europe S.R.L.
str. Hamilton no. 2-4
307210 Giarmata, Romania
Tel: +40-356-635-050
Fax: +40-356-635-060
contact.lab.ro@hamilton.ch

To find a representative in your area, please visit hamiltoncompany.com/contacts.