



memmert

Incubators

PERFECTLY COORDINATED. PERFECTLY CONTROLLED.

INCUBATOR I

CO₂ INCUBATOR IC₀med

COMPRESSOR-COOLED INCUBATOR IC_Peco/IC_P

PELTIER-COOLED INCUBATOR IPP

COOLED STORAGE INCUBATOR IPS

100% ATMOSAFE. MADE IN GERMANY.

www.memmert.com | www.atmosafe.net



Stable. Safe. Sensitive.

Memmert incubators for microbiology.
Energy efficient, precise, 100% AtmoSAFE.

Even slight temperature deviations in the working chamber of an incubator may cause a test to fail. For this reason, the heating and control system of Memmert incubators are perfectly adapted to each other. During heating up and cooling down as well as in running operation, all appliances precisely keep the desired parameters within the smallest tolerance limits. Not only at one measuring point, but in the entire working chamber. Each individual Memmert incubator complies with the strict requirements of DIN 12880:2007-05 and is equipped with a maximum of safety functions. Each individual Memmert incubator is 100% AtmoSAFE.

INCUBATORS I**PAGE 4 - 8**

Microbiological tests, colony counts, virology, toxicology

CO₂ INCUBATORS IC₀med**PAGE 9 - 13**

Medical device class IIa for cultivation of cells or tissue, in-vitro fertilisation, gene expression

COMPRESSOR-COOLED INCUBATORS ICP₀eco**PAGE 14 - 17**

Microbiological tests, colony counts, virology, toxicology, cultivation above and below room temperature, alternate stability tests

COMPRESSOR-COOLED INCUBATORS ICP**PAGE 18 - 19**

Microbiological tests, colony counts, virology, toxicology, cultivation above and below room temperature, alternate stability tests

PELTIER-COOLED INCUBATORS IPP**PAGE 20 - 24**

Protein crystallography, microbiological tests, colony counts, virology, toxicology, cultivation above and below room temperature, alternate stability tests

COOLED STORAGE INCUBATORS IPS**PAGE 25 - 28**

Microbiological tests, cultivation above and below room temperature, stability tests

ADDITIONAL INFORMATION**PAGE 29**



Incubator IN/INm and IF/IFm with SingleDISPLAY
Incubator INplus/INmplus and IFplus/IFmplus
with TwinDISPLAY
Natural convection or forced air circulation
AtmoCONTROL software

Model sizes:
30 / 55 / 75 / 110 / 160 / 260 / 450 / 750
+20 °C to +80 °C

INCUBATOR I Memmert incubators I are at home in the world of research, medicine, pharmaceuticals and food technology. Organic chamber loads require gentle heating. For this reason, the heating and control system are especially optimised for low temperatures of up to +80 °C. To prevent temperature overshoots, temperature is increased within a very narrow control range and kept exactly at the setpoint value. As required, the models with natural convection or with forced air circulation are available.

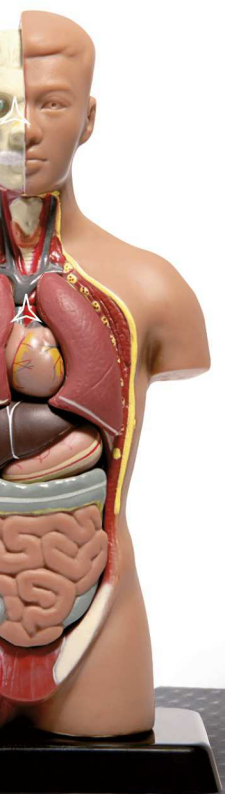

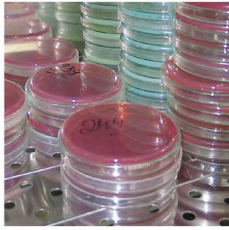

As little air circulation as possible in the incubator

Forced air convection may destroy the protective layer from moist air that is generated during incubation over the samples. This would lead to dehydration of the culture. In a Memmert incubator, the perfect combination of all-round surface heating and temperature control system ensures that incubation generally takes place without forced air circulation. Provided the chamber is fully loaded and forced air circulation is required, it can be precisely adjusted in 10 % steps from 0 to 100 %.

Sterilisation

The chamber of the incubators INplus/IFplus/INmplus and IFmplus, including all installations and sensors, can be sterilised at +160 °C in a 4-hour programme to guarantee optimum hygiene.

Fresh air is preheated

Temperature deviations caused by fresh air can influence sample characteristics or prolong drying. In Memmert incubators, the fresh air is therefore fed through a pre-heating chamber and seamlessly introduced into the working chamber.

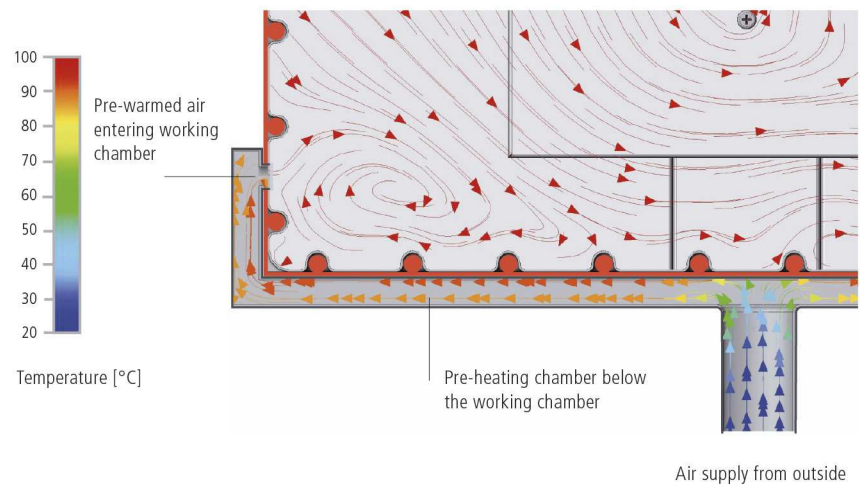

The incubator Im is a medical device:

The incubator Im is a Class I medical device in accordance with the EU directive 93/42/EEC. In accordance with the intended use incubators INmplus and IFmplus may be used for warming of rinsing solutions and infusions as well as of contrast agents. Incubators INm are intended for heating fango, silicate and APS packs for physical therapy and keeping them warm.

INCUBATORS I

according to DIN 12880:2007-05, EN 61010-1 (IEC 61010-1), EN 61010-2-010

Standard units are safety-approved and bear the test marks:
(EAC not valid for medical devices)



- Interior:** Stainless steel, material 1.4301 (ASTM 304) with all-round deep-drawn ribs to integrate the large-area heating with ceramic-metal sheath
- Housing:** Textured stainless steel, rear zinc-plated steel, intuitively operated SingleDISPLAY or TwinDISPLAY (TFT colour display) with touchscreen; inner glass door, outside fully insulated stainless steel door (from size 450 two leaves)
- Fresh air:** Admixture of pre-heated fresh air by electronically adjustable airflap
- Connection:** Mains cable with plug (German type)
- Installation:** 4 feet; sizes 450/750 mounted on lockable castors
- Interfaces:**
- Ethernet
LAN

USB
- USB: only TwinDISPLAY

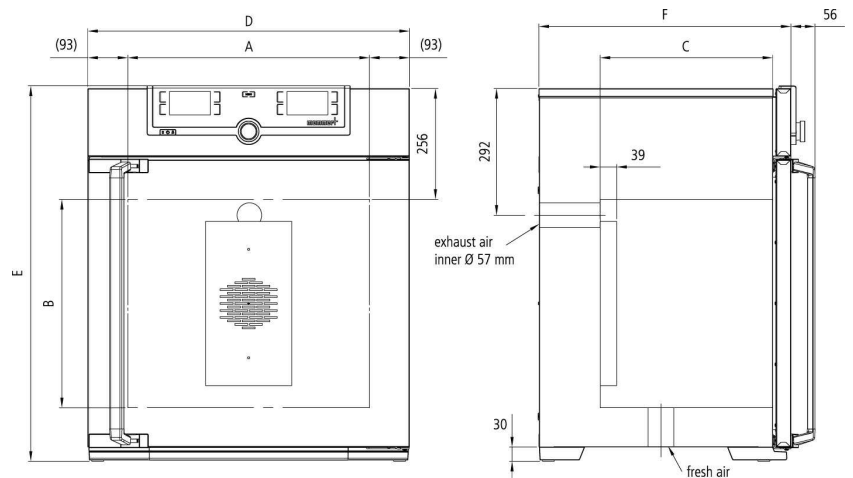

Model sizes/Description			30	55	75	110	160	260	450	750	
Stainless steel interior	Volume	approx. l	32	53	74	108	161	256	449	749	
	Width	(A) mm	400		560		640		1040		
	Height	(B) mm	320	400	560	480	720	800	720	1200	
	Depth (less 39 mm for fan)	(C) mm	250	330		400		500		600	
	Max. number of grids/shelves	number	3	4	6	5	8	9	8	14	
	Max. loading per grid/shelf	kg	20								30
	Max. loading of chamber	kg	60	80	120	175	210	300			
	Max. loading per slide-in drip tray	kg	1,5			3		4		8	
Max. loading per bottom drip tray	kg	1,5			3		4		8		
Textured stainless steel exterior	Width	(D) mm	585		745		824		1224		
	Height (size 450, 750 with castors)	(E) mm	704	784	944	864	1104	1183	1247	1720	
	Depth (without door handle), door handle +56 mm	(F) mm	434	514		584		684		784	
Standard equipment	Stainless steel grids, electropolished	number	1			2					
	Standard works calibration certificate (measuring point chamber center)	°C	+37								
Temperature	Working temperature range	°C	at least 5 (IN/INplus/INm/INmplus) 10 (IF/IFplus/IFm/IFmplus) above ambient temperature up to +80								
	Setting temperature range	°C	+20 to +80								
	Setting accuracy	°C	0.1								
Further data	Electrical load at 230 V, 50/60 Hz	approx. W	1600	1000	1250	1400	1600	1700	1800	2000	
	Electrical load at 115 V, 50/60 Hz	approx. W	800	900			1500		1800		
Packing data	Net weight	approx. kg	48	57	66	76	96	110	161	217	
	Gross weight (packed in carton)	approx. kg	64	76	85	101	122	161	227	288	
	Width	approx. mm	660	730		830		930		1330	
	Height	approx. mm	890	950	1130	1050	1300	1380	1440	1910	
	Depth	approx. mm	650	670		800		930		1050	

Order No. Incubators

I = Incubator

N = Natural convection

F = Forced convection

m = Medical device

plus = Model with TwinDISPLAY

IN30	IN55	IN75	IN110	IN160	IN260	IN450	IN750
IN30m	IN55m	IN75m	IN110m	IN160m	IN260m	IN450m	IN750m
IN30plus	IN55plus	IN75plus	IN110plus	IN160plus	IN260plus	IN450plus	IN750plus
IN30mplus	IN55mplus	IN75mplus	IN110mplus	IN160mplus	IN260mplus	IN450mplus	IN750mplus
IF30	IF55	IF75	IF110	IF160	IF260	IF450	IF750
IF30m	IF55m	IF75m	IF110m	IF160m	IF260m	IF450m	IF750m
IF30plus	IF55plus	IF75plus	IF110plus	IF160plus	IF260plus	IF450plus	IF750plus
IF30mplus	IF55mplus	IF75mplus	IF110mplus	IF160mplus	IF260mplus	IF450mplus	IF750mplus

Options	30	55	75	110	160	260	450	750
Voltage 115 V, 50/60 Hz						X2		
Extended overtemperature protection by additionally integrated Pt100 sensor for independent temperature monitoring for models with SingleDISPLAY						A6		
Chamber modification for the application of reinforced perforated stainless steel shelves or stainless steel grids (bearing rails mounted in the working chamber) - includes replacement of standard grids by reinforced grids				-			K1	
Interior lighting for observing the load						R0		
Interior socket (can only be ordered with limited temperature range - max. +70 °C), ampacity 230 V, 2.2 A, can be switched off with the On/Off switch, cannot be switched individually, moisture tight IP68 (only with SingleDISPLAY), (option A8 necessary)						R3		
Interior socket (can only be ordered with limited temperature range - max. +70 °C), ampacity 230 V/2.2 A, can be switched on/off via tumbler switch in control panel, moisture tight IP68 (requires option A8)						R4		
Entry port, 23 mm clear diameter, for introducing connections at the side, can be closed by flap and silicone stopper, standard positions				left centre/centre left centre/top right centre/centre right centre/top		F0 F1 F2 F3		
Entry port, 23 mm clear diameter, can be closed by flap, in special positions (please state location)				left right rear		F4 F5 F6		
Entry port, 14 mm clear diameter, can be closed by flap, in special positions in the back wall (please, state location)						D6		
Entry port, 38 mm clear diameter, can be closed by flap, in special positions in the back wall (please, state location)						F7		
Entry port, 57 mm clear diameter, can be closed by flap, in special positions in the back wall (please, state location; not possible for IF/IFplus/IFm/IFmplus size 30-75)						F8		
Entry port, 100 mm clear diameter, can be closed by flap, in special positions in the back wall (please, state location; not possible for UF/UFplus/UFm/UFmplus size 75)		-				F9		
4 - 20 mA current loop interface (0 to +90 °C = 4 - 20 mA)			Temperature controller, actual value			V3		
			Temperature of a Pt100 sensor positioned flexibly in chamber for external temperature monitoring (max. 1 SingleDISPLAY, max. 3 TwinDISPLAY) - price per sensor			V6		
Fan speed monitoring with switching-off the heating and with alarm in case of failure - only for IFplus/IFmplus						V4		
Works calibration certificate for 3 temperatures: +37 °C, +52 °C, +70 °C						D00126		
Works calibration certificate for one (freely selectable) temperature value according to customer specification						D00109		
Door with lock and key (safety lock)						B6		
Door hinged on the left				B8				-
Potential-free contact (24 V/2 A) with socket, according to NAMUR NE 28 for external monitoring (indicates when setpoint is reached)						H5		
Potential-free contact for combination error message (e.g. supply failure, sensor fault, fuse)						H6		
Potential-free contact (24 V/2 A) with socket to NAMUR NE 28, for signal generation, controlled by programme segment, for free-selectable functions to be activated (e.g. activation of audible and visual signals, exhaust motors, fans, stirrers, etc.). Only for units with TwinDISPLAY			2 contacts			H72		
Process-dependent programmable door lock (only for units with TwinDISPLAY)						D4		
Door-open-recognition (only for units with TwinDISPLAY)						V5		
Flexible Pt100 for positioning in chamber or in load with socket, 4-pin, according to NAMUR NE 28, for external temperature recording (load temperature) max. 3 sensors						H4		
Flexible Pt100 temperature sensor, positioned flexibly in chamber or load, for local temperature measurement (up to 3 additional sensors are possible). The measured temperature can, if required, be indicated on the display, recorded in the integral data store, and can be documented via the AtmoCONTROL software						H8		
MobileALERT, notification by SMS in case of any error or alarm of the device. Requires option H6						C3		
Temperature restriction; Temperatures: +50, +55, +60, +65, +70 or +75°C (Please, indicate upon ordering)						A8		
Fresh-air filter (filtration efficiency 80 %) mounted at the appliance bottom (for IF/IFplus/IFm/IFmplus). For sizes 30 – 260 castor frame R9 or subframe necessary						R8		
Castor frame (2-part), height 140 mm				R9				-

Accessories	30	55	75	110	160	260	450	750	
Stainless steel grid, electropolished	E28884	E20164		E20165		E28891	E20182		
Additional reinforced stainless steel grid, electropolished, max. loading 60 kg; from size 450 with guide bars and fixing screws (only in connection with option K1). Please consider max. loading of chamber		-		E29767		E29766	B32190		
Perforated stainless steel shelf	B29727	B03916		B00325		B29725	B00328		
Additional reinforced stainless steel shelf, max. loading 60 kg; with guide bars and fixing screws (only in connection with option K1). Please consider max. loading of chamber		-					B32191		
Stainless steel slide-in drip tray, 15 mm rim (may affect the temperature distribution) - cannot be used in connection with option K1	E02070	E02072		E02073		E29726	E02075		
Stainless steel slide-in drip tray, 15 mm rim, with guide bars and fixing screws (may affect the temperature distribution) - can be used only in connection with option K1		-					B32763		
Stainless steel bottom drip tray, 15 mm rim (may affect the temperature distribution) - cannot be used in connection with option K1	B04356	B04358		B04359		B29722	B04362		
Stainless steel bottom drip tray, 15 mm rim (may affect the temperature distribution) - can be used only in connection with option K1		-					B34055		
Wall bracket for wall mounting	B29755	B29756	B29757	B29758	B29759	-			
Guarantee extension by 1 year	GA1Q5					GA2Q5			
USB-Ethernet adapter						E06192			
Ethernet connection cable 5 m for computer interface						E06189			
USB User-ID stick (with User-ID licence): Oven-linked authorisation licence (User-ID-programme) on Memory-stick, prevents undesired manipulation by unauthorised third parties. When reordering please specify serial number (only for units with TwinDISPLAY)						B33170			
USB stick with documentation software AtmoCONTROL and operation manual for products with SingleDISPLAY (the standard equipment of appliances with TwinDISPLAY includes one USB stick with AtmoCONTROL). When reordering please specify serial number						B33172			
Set of height adjustable feet (4 pcs)	B29768					-			
Stacking set (4 pcs) for stacking of appliances of same size	B29744					-			
Plug-in tube extension (outer diam. 60.3 mm, inner 57 mm), straight, for exhaust air ducting (if necessary for connection by hose)						B29718			
Plug-in tube extension (outer diam. 60.3 mm, inner 57 mm), angled, for exhaust air ducting (if necessary for connection by hose)						B29719			
Flush-fit unit (stainless steel frame covering gap between oven and wall opening), with air slots	B29728	B29730	B29732	B29734	B29736	B29738	B29740	B29742	
Flush-fit unit (stainless steel frame covering gap between oven and wall opening), without air slots	B29729	B29731	B29733	B29735	B29737	B29739	B29741	B29743	
Subframe, adjustable in height (size 30 to 75: height 600 mm, size 110 to 450: height 500 mm)	B29745	B29747		B29749		B29751	B29753	-	
Subframe, on castors (size 30 to 75: height 660 mm, size 110 to 160: height 560 mm)	B29746	B29748		B29750		-			
Subframe, adjustable in height, height 130 mm, for example for units with fresh air filter	B33657	B33659		B33661		B33664	-		
Software conforming to FDA AtmoCONTROL. Meets the requirements for the use of electronically stored data sets and electronic signatures as laid down in Regulation 21 CFR Part 11 of the US Food and Drug Administration (FDA). Base licence for the control of one unit (only for units with TwinDISPLAY). Respective IQ/OQ documents available in German and English language (without surcharge)						FDAQ1			
Integration of one additional unit (up to max. 15 units) into an already existent FDA-software licence (only for units with TwinDISPLAY)						FDAQ2			
IQ document with device-specific works test data, OQ/PQ check list as support for validation by customer						D00124			
IQ/OQ document with device-specific works test data for one free-selectable temperature value, incl. temperature distribution survey at Memmert for 9 measuring points (size 30), 27 measuring points (sizes 55 - 1060) to DIN 12880:2007-05. PQ check list as support for validation by customer. 305 € for further temperature values and validation at customer site on demand (GER, AT, CH only)	D00125						D00127		



CO₂ Incubator ICOMed with TwinDISPLAY
Software AtmoCONTROL

Model sizes: 50 / 105 / 150 / 240
+18 °C to +50 °C
Humidity 40 to 97 % rh
CO₂ concentration 0 to 20 %
O₂ concentration 1 to 20 %

CO₂ INCUBATOR ICOMed Safety at all times. When it comes to safety and user friendliness, the highly modern CO₂ incubator ICOMed is the perfect solution: Thanks to the battery-buffered ControlCOCKPIT, the operating display, logging and CO₂ control remain fully functional even when there is a power failure. All parameters are logged in accordance with the FDA and, when individually adjusted ranges for CO₂, O₂, temperature and humidity are exceeded, notifications can be sent to a mobile phone in addition to an alarm.

The control technology is so finely tuned that the setpoint temperature is guaranteed to be reached without temperature overshoots. With its rounded corners, the interior is easy to clean and can be sterilised for 60 minutes at 180 °C (including all sensors).

All ICOMed models are classified as medical product class IIa.

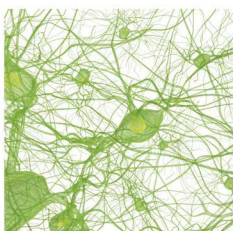

Unrivalled user friendliness

All parameters can be set easily and intuitively both with the ControlCOCKPIT or the AtmoCONTROL software. The shutter box can be opened, allowing fast access to controls. Maintenance is possible even if the appliances are stacked. The appliance has USB and Ethernet connections as well as a data logger with a ten-year storage capacity. Data can be read and programmes can be transferred by remote access.



Minimising vaporisation and condensation

The active humidity control minimises vaporisation in the interior and ensures short recovery times after the door has been opened. Together with the heating of the interior from all six sides including the heated inner glass door, it prevents the dangerous formation of condensation and offers maximum protection for cell and tissue cultures. The turbulence-free chamber ventilation ensures a constant and uniform atmosphere.



IVF module for models ICO50med/ICO105med

In order to keep vaporisation, condensation and recovery times at a minimum during in vitro fertilisation, the Petri dishes are cultivated in separate slide-in units. The slide-in units in the optional IVF module can be pulled out easily and with low vibration and are equipped with a pull-out lock.



The CO₂ Incubator ICOfed is a medical device:

Memmert subjected its CO₂ incubator ICOfed to a comprehensive medical device evaluation. Every Memmert CO₂ incubator ICOfed is classified as a Class IIa medical device. The ICOfed is intended for the creation and maintenance of constant environmental conditions for application in the field of in vitro fertilisation (IVF), especially for the incubation of oocytes, spermatozoa and zygotes in special culture dishes for IVF application as well as for gene expression and the biosynthesis of RNA and proteins. The CE label on the appliances includes the mark 0197, denoting TRLP – TÜV Rheinland as the notified body.



CO₂ INCUBATORS IComed

according to DIN 12880:2007-05, EN 61010-1 (IEC 61010-1), EN 61010-2-010

Standard units are safety-approved and bear the test marks:



Interior: Stainless steel, material 1.4301 (ASTM 304), deep-drawn, seamlessly welded

Housing: Textured stainless steel, rear zinc-plated steel, intuitively operated TwinDISPLAY (TFT colour display) with touchscreen; fully insulated stainless steel door and heated inner glass door

Automatic sterilisation: Humidity and CO₂ sensor sterilised inside the CO₂ incubator

Connection: Mains cable with plug (German type)

Installation: 4 adjustable feet

Interfaces:

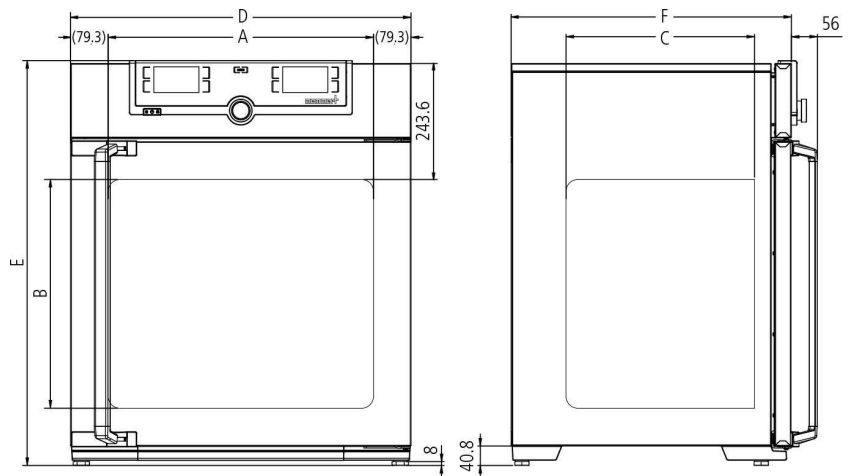
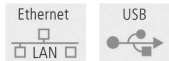

Model sizes/Description			50	105	150	240
Stainless steel interior	Volume	approx. l	56	107	156	241
	Width	(A) mm	400	560		600
	Height	(B) mm	425	480	700	810
	Depth (less 35 mm for fan)	(C) mm	330	400		500
	Max. number of perforated shelves	number	5	6	10	12
	Max. loading per perforated shelf	kg	15			
	Max. loading of chamber	kg	75	90	120	140
Textured stainless steel exterior	Width	(D) mm	559	719		759
	Height (variable through adjustable feet)	(E) mm	795	850	1070	1180
	Depth (without door handle, depth of door handle 56 mm)	(F) mm	521	591		691
	Fully insulated heated stainless steel door			●		
	Additional heated inner glass door			●		
Standard equipment	Stainless steel shelves, perforated	number	1	2		
	Stainless steel water dish (not applicable with option K7)	number		1		
	Works calibration certificate (measuring point chamber centre) at +37 °C, 5 % CO ₂ for standard units			●		
	Works calibration certificate at 37 °C, 5 % CO ₂ , 90 % rh and 10 % O ₂ (requires option K7 and option T6); standard equipment for units with O ₂ control			●		
	Works calibration certificate at 37 °C, 5 % CO ₂ and 90 % rh (requires option K7); standard equipment for units with active humidity control			●		
	CO ₂ connection set: hose with coupling and clamp			●		
	Standard sterilisation programme (without removing the sensors), humidity and CO ₂ sensor sterilised inside the CO ₂ incubator			60 minutes at 180 °C		
Membrane filter (in order to remove impurities and pollutants, all incoming gases pass through a membrane filter before they reach the chamber)			●			
Temperature	Working temperature range	°C	at least 5 above ambient temperature up to +50			
	Setting temperature range	°C	+18 to +50			
	Setting accuracy	°C	0.1			
	Temperature fluctuations with time at 37 °C (to DIN 12880:2007-05)	K	+/- 0.1			
	Temperature variation in chamber at + 37 °C (to DIN 12880:2007-05)	K	+/- 0.3			
Humidity	Humidity limitation thanks to a Peltier element; when water dish is full and inserted, the Peltier element limits the value of relative humidity in the interior to 93 % rh +/- 2.5 %		●			
	Setting range active humidity control (with option K7)	% rh	40 to 97 and rh-Off			
	Setting accuracy	% rh	0.5			
CO ₂ / O ₂	Digital electronic CO ₂ control with dual beam NDIR system, with auto-diagnostic system and acoustic fault indication, barometric pressure compensation		●			
	Setting range CO ₂	% CO ₂	0 to 20			
	Variation in time CO ₂	% CO ₂	+/- 0.2			
	Setting accuracy CO ₂	% CO ₂	0.1			
	Setting range O ₂	% O ₂	1 to 20			
	Setting accuracy O ₂	% O ₂	0.1			
Further data	Electrical load at 230/115 V, 50/60 Hz	approx. W	1100	1300	1500	1650

Model sizes/Description		50	105	150	240	
Packing data	Net weight	approx. kg	55	75	90	110
	Gross weight (packed in carton)	approx. kg	74	100	116	145
	Width	approx. mm	730	800		840
	Height	approx. mm	950	1030	1250	1360
	Depth	approx. mm	640	800		900
Order No. CO₂ Incubators			IC050med	IC0105med	IC0150med	IC0240med
Options		50	105	150	240	
Voltage 115 V, 50/60 Hz			X2			
Battery-buffered ControlCOCKPIT: Uninterrupted supply for the entire display unit (ControlCOCKPIT) and therefore complete documentation of all parameters even when there is a power failure. The CO ₂ parameter is continuously regulated			C2			
Two gas connections with quick release connectors for automatic switch-over of gas cylinders; incl. two CO ₂ connection sets: hose with coupling and clamp			T1			
Electropolished interior			T2			
Active microprocessor control for humidifying and dehumidifying (40 - 97 % rh), incl. digital indication and auto-diagnostic system ensures even more rapid reaching of set humidity and very short recovery times while avoiding condensate formation. Humidity supply with water (only for demineralised water with a conductivity of 5 to 10 µS/cm and a pH value between 5 and 7; from an external tank) by a self-priming pump; integral bacteria block by generating hot steam, dehumidifying via sterile filter			K7			
Control of oxygen concentration by N ₂ inlet; adjustment range 1 % up to 20 % O ₂ ; setting accuracy 0.1 % (requires option K7). Incl. N ₂ connection set: hose with coupling and clamp			T6			
Peltier cooling unit enables a working temperature of 37 °C even at higher ambient temperatures of up to 35 °C			K5			
Capacitive humidity sensor for measuring and displaying the relative humidity			K6			
Entry port (silicone), 40 mm clear diameter, moisture tight, can be closed by silicone stopper, at the back, centre right; not available for IC050med with active humidity control (option K7) or humidity display (option K6)			F7			
Inner door with partitioned glass doors (cannot be used in connection with option B8); size 105/150/240 has 2/3/4 partitioned glass doors		-	K4			
4 - 20 mA current loop interface	Temperature controller, actual value (0 to +70 °C = 4 - 20 mA)		V3			
	Humidity controller, actual value (0 to 100 % rh = 4 - 20 mA) (requires option K7 or K6)		V7			
	CO ₂ controller, actual value (0 to 25 % CO ₂ = 4 - 20 mA)		V9			
	O ₂ controller, actual value (0 to 25 % O ₂ = 4 - 20 mA) (requires option T6)		V1			
Works calibration certificate for 5 %, 7 % and 10 % CO ₂ (measured at +37 °C) special works calibration certificates upon request			D00106			
Works calibration certificate for one (freely selectable) temperature, humidity and CO ₂ value according to customer specification (requires K7)			D00131			
Works calibration certificate for one (freely selectable) temperature, humidity, CO ₂ and O ₂ value according to customer specification (requires T6)			D00143			
Start-up of ICOMed incubators and brief training (GER, AT, CH only), through Memmert service, not subject to discount			K9			
Door hinged on the left			B8			
Potential-free contact (24 V/2 A) with socket to NAMUR NE 28 for external monitoring (indicates when set points of temperature and CO ₂ are reached)			H5			
Potential-free contact for combination error message (e.g. supply failure, sensor fault, fuse)			H6			
MobileALERT, notification by SMS in case of any error or alarm of the device. Requires option H6			C3			
MobileALERT for up to 4 alarm notifications; temperature and CO ₂ alarm (standard), additionally humidity alarm (when equipped with option K7) and O ₂ alarm (when equipped with option T6)			C4			
Accessories		50	105	150	240	
Perforated stainless steel shelf		E35160		E37418	E35158	
Water dish			B38737			
Subframe (622 mm high) adjustable in height (sizes 150/240: should not be used for 2 stacked units)		B33504		B33505	B33506	
Subframe (130 mm high); sizes 150/240: only in combination with the corresponding stacking sets for stacked appliances		B33507		B33508	B33509	
Subframe, on castors (height 120 mm; stainless steel, material 1.4301)			-		B43598	
HEPA-filter for chamber according to EN 1822, packed in sterile condition, incl. fixing unit			B38739			
CO ₂ pressure reducing valve to DIN 8546, incl. gas cylinder monitor			E02087			
N ₂ pressure reducing valve to DIN EN ISO 2503, incl. gas cylinder monitor (requires option T6)			E06162			
Central water supply, with filter cartridges for connection to the domestic water supply, only in combination with option K7. Product information on demand			ZWVR6			
Central water supply, without filter cartridges for connection to the domestic water supply (only for demineralised water with a conductivity of 5 to 10 µS/cm and a pH value between 5 and 7) only in combination with option K7. Product information on demand			ZWVR7			
Guarantee extension by 1 year			GA3Q5			
Celltron benchtop shaker (not subject to discount) - accessories upon request		-	E06724			

Accessories	50	105	150	240
IVF-module for IC050med: patented consisting of 6 slide-in units, a total of 12 special racks with indentations for 12 Petri dishes (60 mm diam.) resp. 24 Petri dishes (35 mm diam.), 2 racks with indentations for 3 special media tubes each; racks with indentations for 4-well dishes on demand; only for IC050med with the options K7 and F7; works calibration certificate (measuring point chamber centre) at +37 °C, 5 %, 6 % and 7 % CO ₂ as well as 90 % rh; 5 % O ₂ for IVF unit equipped with option T6	B44128		-	
IVF-module for IC0105med: patented, consisting of 8 slide-in units, a total of 16 special racks with indentations for 16 Petri dishes (60 mm) resp. 32 Petri dishes (35 mm diam.), 2 racks with indentations for 3 special media tubes each; racks with indentations for 4-well dishes on demand; only for IC0105med with the options K7 and F7; works calibration certificate (measuring point chamber centre) at 37 °C, 5 %, 6 % and 7 % CO ₂ as well as 90 % rh; 5 % O ₂ for IVF unit equipped with option T6	-	B42398		-
Holder for Petri dishes round (only in combination with IVF-module)		E37026		-
Holder for Petri dishes square (only in combination with IVF-module)		E37308		-
Holder for test tube (only in combination with IVF-module)		E37069		-
Magnetic foil, can be labelled with a non-permanent board marker (only in combination with IVF-module)	E07620	E36651		-
USB-Ethernet adapter			E06192	
Ethernet connection cable 5 m for computer interface			E06189	
USB User-ID stick (with User-ID licence): Oven-linked authorisation licence (User-ID-programme) on Memory-stick, prevents undesired manipulation by unauthorised third parties. When reordering please specify serial number			B33170	
Stacking set (4 pcs) for stacking of appliances of same size		B29744		-
Stacking set (consisting of stacking corners, one connecting plate for the rear, two wall brackets) for stacking of two units of same size		-	B42114	-
Stacking set (consisting of stacking corners, one connecting plate for the rear, two wall brackets) for stacking of two units of same size (only in combination with subframe B33509 or B43598)		-		B48129
FDA conforming software AtmoCONTROL (FDA edition). Meets the requirements for the use of electronically stored data sets and electronic signatures as laid down in Regulation 21 CFR Part 11 of the US Food and Drug Administration (FDA). Base licence for the control of one unit. Respective IQ/OQ documents available in German and English language (without surcharge)			FDAQ1	
Integration of additional units (up to max. 15 units) into an already existent FDA-software licence			FDAQ2	
IQ document with device-specific works test data, OQ/PQ check list as support for validation by customer			D00124	
IQ/OQ document with device-specific works test data for one free-selectable CO ₂ , humidity and temperature value, incl. temperature distribution survey at Memmert for 27 measuring points to DIN 12880:2007-05, PQ check list as support for validation by customer (a free-selectable humidity value is only possible with option K7). Price for validation at customer site on demand (GER, AT, CH only)			D38897	
IQ/OQ document with device-specific works test data for one free-selectable CO ₂ and temperature value, incl. temperature distribution survey at Memmert for 27 measuring points to DIN 12880:2007-05, PQ check list as support for validation by customer. Price for validation at customer site on demand (GER, AT, CH only)			D38898	
External measuring instrument with additional measuring head for temperature and humidity measurement. Product information on demand			B04714	



CO₂-cooled incubator ICPeco
with TwinDISPLAY
AtmoCONTROL software

Model sizes: 110 / 260 / 450 / 750
-12 °C to +60 °C

COMPRESSOR-COOLED INCUBATOR ICPeco These environmentally-friendly cooled incubators are cooled with almost climate-neutral CO₂. Thanks to this refrigerant's excellent thermodynamic properties and the finely adjusted control technology, an ICPeco is both powerful and high-precision. Without critical temperature overshoots, it keeps the temperatures exactly at the setpoint.



Refrigerant CO₂ is climate-friendly

A CO₂-cooled incubator ICPeco is in every respect positive for the ecological balance of a laboratory. Legal restrictions for use are completely excluded in the future, as the refrigerant CO₂ (R744), unlike fluorine-based refrigerants, has no greenhouse gas reduction potential. It is a by-product of industrial processes, which is why far less energy is used for its manufacture than for synthetic, fluorinated refrigerants. R744 is neither flammable nor toxic and does not cause ozone depletion in the atmosphere.



Refrigerant CO₂ ensures better cooling performance

The contribution to process optimisation is also impressive. An ICPeco is extremely powerful. Compared to appliances with R134a as refrigerant, it has faster temperature change rates during cooling-down.



Completely enclosed working chamber

Cooling and heating units are situated outside the working chamber inside the air jacket temperature control system surrounding the entire chamber interior ensuring quick and precise temperature control. The motor-driven forced air circulation, adjustable in 10 % steps via the ControlCOCKPIT ensures optimum temperature distribution.

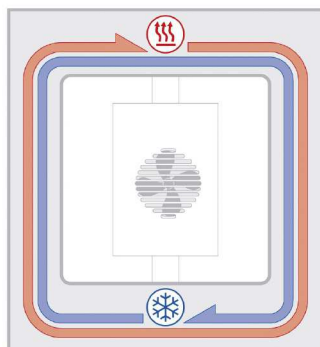

ICP air jacket temperature control system

Integrated energy saving function

The cooling unit works extremely energy-efficient because the heating is completely switched off in cooling mode. An intelligent DEFROST function enables defrosting as required.

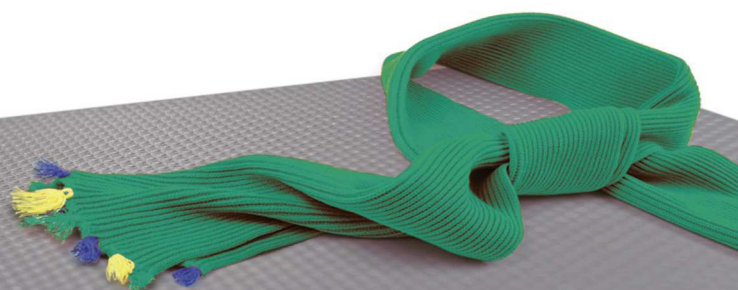

COMPRESSOR-COOLED INCUBATORS ICPeco

according to DIN 12880:2007-05, EN 61010-1 (IEC 61010-1), EN 61010-2-010

Standard units are safety-approved and bear the test marks:



Interior: Stainless steel, material 1.4301 (ASTM 304)
Housing: Textured stainless steel, rear zinc-plated steel, intuitively operated TwinDISPLAY (TFT colour display) with touchscreen; inside glass door, outside fully insulated stainless steel door (from size 450 two leaves)

Connection: Mains cable with plug (German type)

Installation: Mounted on lockable castors

Interfaces:

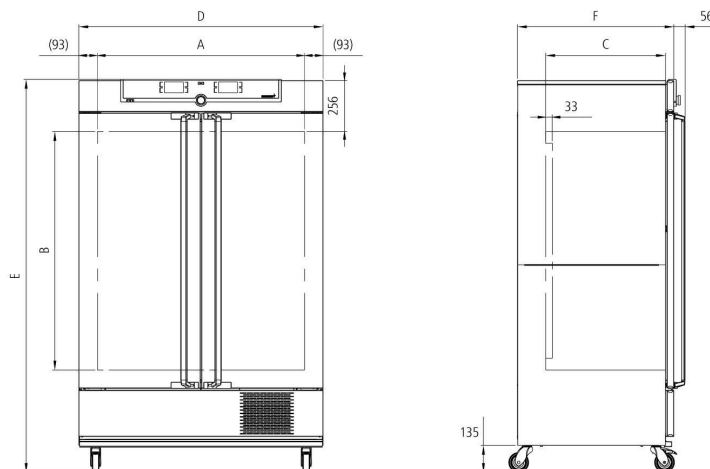

Model sizes/Description			110	260	450	750
Stainless steel interior	Volume	approx. l	108	256	449	749
	Width	(A) mm	560	640	1040	
	Height	(B) mm	480	800	720	1200
	Depth (less 33 mm for fan)	(C) mm	400	500	600	
	Max. number of grids/shelves	number	5	9	8	14
	Max. loading per grid/shelf	kg	20		30	
	Max. loading of chamber	kg	150	200		
	Max. loading per slide-in drip tray	kg	3	4	8	
Max. loading per bottom drip tray	kg	3	4	8		
Textured stainless steel exterior	Width	(D) mm	745	824	1224	
	Height (with castors)	(E) mm	1233	1552	1467	1950
	Depth (without door handle), door handle + 56 mm	(F) mm	584	684	784	
Standard equipment	Stainless steel grids, electropolished	number	2			
	Standard works calibration certificate (measuring point chamber center)	°C	+10 and +37			
Temperature	Working temperature range (not suitable for long-term storing at sub-zero temperatures. During permanent operation, the inner glass door may ice over)	°C	-12 to +60			
	Setting temperature range	°C	-12 to +60			
	Setting accuracy	°C	0.1			
Further data	Electrical load at 230 V, 50 Hz	approx. W	1200			
Packing data	Net weight	approx. kg	118	162	222	254
	Gross weight (packed in carton)	approx. kg	146	219	287	324
	Width	approx. mm	880	930	1330	
	Height	approx. mm	1410	1760	1700	2150
	Depth	approx. mm	810	930	1050	
Order No. Compressor-Cooled Incubators			ICP110eco	ICP260eco	ICP450eco	ICP750eco

Options	110	260	450	750
Chamber modification for the application of reinforced perforated stainless steel shelves or stainless steel grids (bearing rails mounted in the working chamber) - includes replacement of standard grids by reinforced grids	-			K1
Interior socket, ampacity 230 V/2.2 A, can be switched off with the On/Off switch, cannot be switched individually, moisture tight IP68			R3	
Interior socket (can only be ordered with limited temperature range - max. +70 °C), ampacity 230 V/2.2 A, can be switched on/off via tumbler switch in control panel, moisture tight IP68			R4	
Entry port, 23 mm clear diameter, for introducing connections at the side, can be closed by flap and silicone stopper, standard positions		left centre/centre left centre/top right centre/top	F0 F1	F3
Entry port (silicone), 40 mm clear diameter, moisture tight, can be closed by silicone stopper, at the back (please, state location)			F7	
4 - 20 mA current loop interface		Temperature controller, actual value (-20 to +70 °C = 4 - 20 mA)	V3	
		Temperature of a Pt100 sensor positioned flexibly in chamber for external temperature monitoring (max. 3) - price per sensor (-20 to +70 °C = 4 - 20 mA)	V6	
Fan speed monitoring with switching off the heating and with alarm in case of failure			V4	
Works calibration certificate for 3 temperatures: 0 °C, +37 °C, +60 °C			D00130	
Works calibration certificate for one (freely selectable) temperature value according to customer specification			D00109	
Door with lock and key (safety lock)			B6	
Door hinged on the left	B8			-
Potential-free contact (24 V/2 A) with socket, according to NAMUR NE 28 for external monitoring (indicates when setpoint is reached)			H5	
Potential-free contact for combination error message (e.g. supply failure, sensor fault, fuse)			H6	
Potential-free contact (24 V/2 A) with socket to NAMUR NE 28, for signal generation, controlled by programme segment, for free-selectable functions to be activated (e.g. activation of audible and visual signals, exhaust motors, fans, stirrers, etc.)		2 contacts	H72	
Process-dependent programmable door lock			D4	
Door-open-recognition			V5	
Flexible Pt100 for positioning in chamber or in load with socket, 4-pin, according to NAMUR NE 28, for external temperature recording (load temperature) max. 3 sensors			H4	
Flexible Pt100 temperature sensor, positioned flexibly in chamber or load, for local temperature measurement (up to 2 additional sensors are possible). The measured temperature can, if required, be indicated on the display, recorded in the integral data store, and can be documented via the AtmoCONTROL software			H8	
MobileALERT, notification by SMS in case of any error or alarm of the device. Requires option H6			C3	

Accessories	110	260	450	750
Stainless steel grid, electropolished	E20165	E28891		E20182
Additional reinforced stainless steel grid, electropolished, max. loading 60 kg; from size 450 with guide bars and fixing screws (only in connection with option K1). Please consider max. loading of chamber	E29767	E29766		B32190
Perforated stainless steel shelf	B00325	B29725		B00328
Additional reinforced stainless steel shelf, max. loading 60 kg; with guide bars and fixing screws (only in connection with option K1). Please consider max. loading of chamber		-		B32191
Stainless steel slide-in drip tray, 15 mm rim (may affect the temperature distribution) - cannot be used in connection with option K1	E02073	E29726		E02075
Stainless steel slide-in drip tray, 15 mm rim, with guide bars and fixing screws (may affect the temperature distribution) - can be used only in connection with option K1		-		B32763
Stainless steel bottom drip tray, 15 mm rim (may affect the temperature distribution) - cannot be used in connection with option K1	B04359	B29722		B04362
Stainless steel bottom drip tray, 15 mm rim (may affect the temperature distribution) - can be used only in connection with option K1		-		B34055
USB-Ethernet adapter			E06192	
Ethernet connection cable 5 m for computer interface			E06189	
USB User-ID stick (with User-ID licence): Oven-linked authorisation licence (User-ID-programme) on Memory-stick, prevents undesired manipulation by unauthorised third parties. When reordering please specify serial number			B33170	
FDA conforming software AtmoCONTROL (FDA edition). Meets the requirements for the use of electronically stored data sets and electronic signatures as laid down in Regulation 21 CFR Part 11 of the US Food and Drug Administration (FDA). Base licence for the control of one unit. Respective IQ/OQ documents available in German and English language (without surcharge)			FDAQ1	
Integration of additional units (up to max. 15 units) into an already existent FDA-software licence			FDAQ2	
IQ document with device-specific works test data, OQ/PQ check list as support for validation by customer			D00124	
IQ/OQ document with device-specific works test data for one free-selectable temperature value, incl. temperature distribution survey at Memmert for 27 measuring points to DIN 12880:2007-05. PQ check list as support for validation by customer. 305 € for further temperature values and validation at customer site on demand (GER, AT, CH only)			D00127	

COMPRESSOR-COOLED INCUBATORS ICP

according to DIN 12880:2007-05, EN 61010-1 (IEC 61010-1), EN 61010-2-010

Standard units are safety-approved and bear the test marks: 

Interior: Stainless steel, material 1.4301 (ASTM 304)
Housing: Textured stainless steel, rear zinc-plated steel, intuitively operated TwinDISPLAY (TFT colour display) with touchscreen; inside glass door, outside fully insulated stainless steel door (from size 450 two leaves)

Connection: Mains cable with plug (German type)

Installation: Mounted on lockable castors

Interfaces:

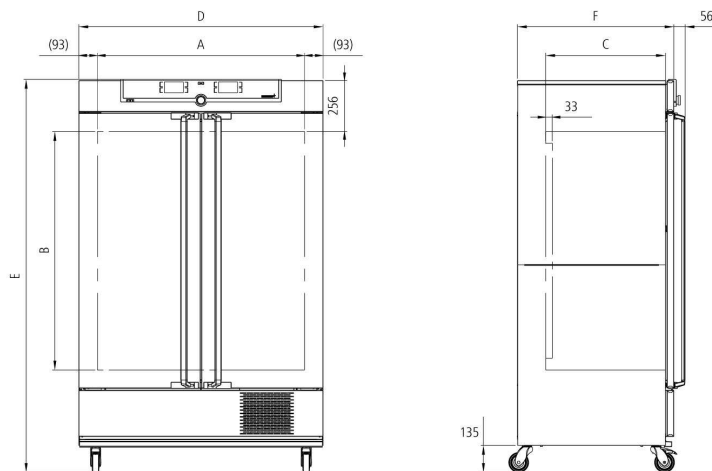

Model sizes/Description			110	260	450	750
Stainless steel interior	Volume	approx. l	108	256	449	749
	Width	(A) mm	560	640	1040	
	Height	(B) mm	480	800	720	1200
	Depth (less 33 mm for fan)	(C) mm	400	500	600	
	Max. number of grids/shelves	number	5	9	8	14
	Max. loading per grid/shelf	kg	20		30	
	Max. loading of chamber	kg	150	200		
	Max. loading per slide-in drip tray	kg	3	4	8	
Max. loading per bottom drip tray	kg	3	4	8		
Textured stainless steel exterior	Width	(D) mm	745	824	1224	
	Height (with castors)	(E) mm	1233	1552	1467	1950
	Depth (without door handle), door handle + 56 mm	(F) mm	584	684	784	
Standard equipment	Stainless steel grids, electropolished	number	2			
	Standard works calibration certificate (measuring point chamber center)	°C	+10 and +37			
Temperature	Working temperature range (not suitable for long-term storing at sub-zero temperatures. During permanent operation, the inner glass door may ice over)	°C	-12 to +60			
	Setting temperature range	°C	-12 to +60			
	Setting accuracy	°C	0.1			
Further data	Electrical load at 230/115 V, 50/60 Hz	approx. W	1200			
Packing data	Net weight	approx. kg	113	157	217	249
	Gross weight (packed in carton)	approx. kg	141	214	282	319
	Width	approx. mm	880	930	1330	
	Height	approx. mm	1410	1760	1700	2150
	Depth	approx. mm	810	930	1050	
Order No. Compressor-Cooled Incubators			ICP110	ICP260	ICP450	ICP750

Options	110	260	450	750
Voltage 115 V, 50/60 Hz			X2	
Chamber modification for the application of reinforced perforated stainless steel shelves or stainless steel grids (bearing rails mounted in the working chamber) - includes replacement of standard grids by reinforced grids		-		K1
Interior socket, ampacity 230 V/2.2 A, can be switched off with the On/Off switch, cannot be switched individually, moisture tight IP68			R3	
Interior socket (can only be ordered with limited temperature range - max. +70 °C), ampacity 230 V/2.2 A, can be switched on/off via tumbler switch in control panel, moisture tight IP68			R4	
Entry port, 23 mm clear diameter, for introducing connections at the side, can be closed by flap and silicone stopper, standard positions			F0 F1	F3
Entry port (silicone), 40 mm clear diameter, moisture tight, can be closed by silicone stopper, at the back (please, state location)			F7	
4 - 20 mA current loop interface		4 - 20 mA current loop interface (-20 to +70 °C = 4 to 20 mA)	V3	
		Temperature of a Pt100 sensor positioned flexibly in chamber for external temperature monitoring (max. 3) - price per sensor (-20 to +70 °C = 4 - 20 mA)	V6	
Fan speed monitoring with switching off the heating and with alarm in case of failure			V4	
Works calibration certificate for 3 temperatures: 0 °C, +37 °C, +60 °C			D00130	
Works calibration certificate for one (freely selectable) temperature value according to customer specification			D00109	
Door with lock and key (safety lock)			B6	
Door hinged on the left		B8		-
Potential-free contact (24 V/2 A) with socket, according to NAMUR NE 28 for external monitoring (indicates when setpoint is reached)			H5	
Potential-free contact for combination error message (e.g. supply failure, sensor fault, fuse)			H6	
Potential-free contact (24 V/2 A) with socket to NAMUR NE 28, for signal generation, controlled by programme segment, for free-selectable functions to be activated (e.g. activation of audible and visual signals, exhaust motors, fans, stirrers, etc.)		2 contacts	H72	
Process-dependent programmable door lock			D4	
Door-open-recognition			V5	
Flexible Pt100 for positioning in chamber or in load with socket, 4-pin, according to NAMUR NE 28, for external temperature recording (load temperature) max. 3 sensors			H4	
Flexible Pt100 temperature sensor, positioned flexibly in chamber or load, for local temperature measurement (up to 3 additional sensors are possible). The measured temperature can, if required, be indicated on the display, recorded in the integral data store, and can be documented via the AtmoCONTROL software			H8	
MobileALERT, notification by SMS in case of any error or alarm of the device. Requires option H6			C3	

Accessories	110	260	450	750
Stainless steel grid, electropolished	E20165	E28891		E20182
Additional reinforced stainless steel grid, electropolished, max. loading 60 kg; from size 450 with guide bars and fixing screws (only in connection with option K1). Please consider max. loading of chamber	E29767	E29766		B32190
Perforated stainless steel shelf	B00325	B29725		B00328
Additional reinforced stainless steel shelf, max. loading 60 kg; with guide bars and fixing screws (only in connection with option K1). Please consider max. loading of chamber		-		B32191
Stainless steel slide-in drip tray, 15 mm rim (may affect the temperature distribution) - cannot be used in connection with option K1	E02073	E29726		E02075
Stainless steel slide-in drip tray, 15 mm rim, with guide bars and fixing screws (may affect the temperature distribution) - can be used only in connection with option K1		-		B32763
Stainless steel bottom drip tray, 15 mm rim (may affect the temperature distribution) - cannot be used in connection with option K1	B04359	B29722		B04362
Stainless steel bottom drip tray, 15 mm rim (may affect the temperature distribution) - can be used only in connection with option K1		-		B34055
USB-Ethernet adapter			E06192	
Ethernet connection cable 5 m for computer interface			E06189	
USB User-ID stick (with User-ID licence): Oven-linked authorisation licence (User-ID-programme) on Memory-stick, prevents undesired manipulation by unauthorised third parties. When reordering please specify serial number			B33170	
FDA conforming software AtmoCONTROL (FDA edition). Meets the requirements for the use of electronically stored data sets and electronic signatures as laid down in Regulation 21 CFR Part 11 of the US Food and Drug Administration (FDA). Base licence for the control of one unit. Respective IQ/OQ documents available in German and English language (without surcharge)			FDAQ1	
Integration of additional units (up to max. 15 units) into an already existent FDA-software licence			FDAQ2	
IQ document with device-specific works test data, OQ/PQ check list as support for validation by customer			D00124	
IQ/OQ document with device-specific works test data for one free-selectable temperature value, incl. temperature distribution survey at Memmert for 27 measuring points to DIN 12880:2007-05. PQ check list as support for validation by customer. 305 € for further temperature values and validation at customer site on demand (GER, AT, CH only)			D00127	



Peltier-cooled incubator IPP with SingleDISPLAY
Peltier-cooled incubator IPPplus with TwinDISPLAY
AtmoCONTROL software

Model sizes: 30 / 55 / 110 / 260 / 410 / 750 / 1060
0 °C to +70 °C

PELTIER-COOLED INCUBATOR IPP Heating and cooling seamlessly with one system thanks to Peltier technology. In this respect, cooled incubators IPP not only contribute to climate protection, but it also achieves an additional decrease in operating costs of up 90 % compared to compressor technology. This perfect development from the environmentally friendly and energy-saving heating/cooling technology by Memmert convinces by outstanding control precision and extremely small fluctuations.



Extremely quiet and vibration-free

The fact that no compressor is required saves space and brings peace and quiet to the laboratory. As Peltier-cooled incubators IPP are almost vibration-free, they can also be applied in entomology. If defined humidity is also required, an alternative would be the constant climate chamber HPP, which is also equipped with Peltier technology.

No condensation in the interior chamber

Due to the closed Peltier cooling system, no outside air is exchanged. Physically derived, unavoidable formation of condensation during the cooling process does not take place in the interior chamber but on the outside heat sink. In addition, the in the Peltier elements integrated fans ensure a rapid transport of energy as well as an optimal temperature distribution.

Energy-saving heating/cooling technology combination

In contrast to compressor systems, Peltier technology is particularly economical at temperatures close to the ambient temperature, since energy is only required during heating or cooling. Therefore heating and cooling function are particularly precisely adjusted to each other.

Comparison between compressor and Peltier technology

Reduction in energy consumption of up to 90 %

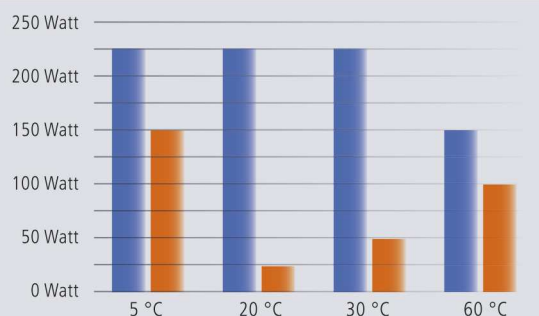

PELTIER-COOLED INCUBATORS IPP

according to DIN 12880:2007-05, EN 61010-1 (IEC 61010-1), EN 61010-2-010

Standard units are safety-approved and bear the test marks:



Interior: Stainless steel, material 1.4301 (ASTM 304), deep-drawn

Housing: Textured stainless steel, rear zinc-plated steel, intuitively operated SingleDISPLAY or TwinDISPLAY (TFT colour display) with touchscreen

Double doors: Outside stainless steel, fully insulated, inside glass (size 750 and 1060 two leaves)

Connection: Mains cable with plug (German type)

Installation: 4 feet; sizes 410 to 1060 mounted on lockable castors

Interfaces:  

USB: only for TwinDISPLAY

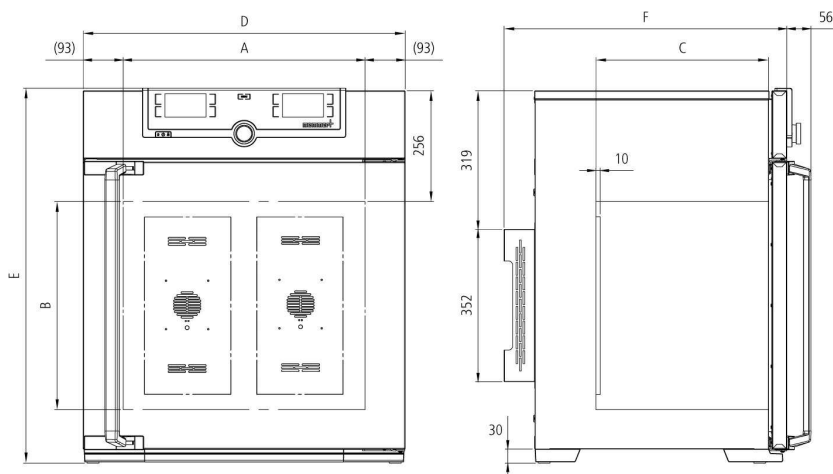

Model sizes/Description			30	55	110	260	410	750	1060	
Stainless steel interior	Volume	approx. l	32	53	108	256	384	749	1060	
	Width	(A) mm	400		560	640		1040		
	Height	(B) mm	320	400	480	800		1200		
	Depth (less 10 mm for fan – Peltier)	(C) mm	250	330	400	500		600	850	
	Max. number of grids/shelves	number	3	4	5	9		14		
	Max. loading per grid/shelf	kg	20					30	20	
	Max. loading of chamber	kg	60	80	150	200				
	Max. loading per slide-in drip tray	kg	1,5		3	4		8		
Max. loading per bottom drip tray	kg	1,5		3	4		8			
Textured stainless steel exterior	Width	(D) mm	585		745	824		1224		
	Height (sizes 400, 750, 1060 with castors)	(E) mm	704	784	864	1183		1720		
	Depth (without door handle), door handle + 56 mm	(F) mm	506	586	656	756		856	1107	
Standard equipment	Stainless steel grids, electropolished	number	1		2					
	Standard works calibration certificate (measuring point chamber center)	°C	+10 and +37							
Temperature	Working temperature range without light	°C	0 (at least 20 below ambient temperature) to +70							
	Working temperature range with light	°C	-		+10 to +40				-	
	Setting temperature range	°C	0 to +70							
	Setting accuracy	°C	0.1							
Further data	Electrical load at 230/115 V, 50/60 Hz	approx. W	140	275	550	820	1030	1300	1500	
	Peltier elements in the rear	number	1		2	3	4	6		
Packing data	Net weight	approx. kg	40	52	78	114	157	230	255	
	Gross weight (packed in carton)	approx. kg	56	71	103	165	210	301	419	
	Width	approx. mm	660	730	830	930		1330	1370	
	Height	approx. mm	890	950	1050	1380	1930	1910	1970	
	Depth	approx. mm	650	670	800	930		1050	1300	

Order No. Peltier-Cooled Incubators

IPP = Peltier-Cooled Incubators

plus = Model with TwinDISPLAY

IPP30	IPP55	IPP110	IPP260	IPP410	IPP750	IPP1060
IPP30plus	IPP55plus	IPP110plus	IPP260plus	IPP410plus	IPP750plus	IPP1060plus

Options	30	55	110	260	410	750	1060
Voltage 115 V, 50/60 Hz	X2						
Chamber modification for the application of reinforced perforated stainless steel shelves or stainless steel grids (bearing rails mounted in the working chamber) - includes replacement of standard grids by reinforced grids						K1	-
Light module cold white 6,500 K: light strips arranged on the side walls of the interior, 10 strips for model 110, 14 for model 260/400/750, programme-controlled dimming from 0 to 100 % (in 1 % steps), ramp programming in combination with temperature (only with TwinDISPLAY; not in combination with F6, D6, F7)	-			T7			-
Light module cold white 6,500 K + warm white 2,700 K: LED light strips - 10 strips for model 110, 14 for model 260/400/750 - (5 resp. 7 alternating cold white light strips and 5 resp. 7 warm white light strips) on the side walls of the interior, programme-controlled dimming from 0 to 100 % (in 1 % steps), ramp programming in combination with temperature (only with TwinDISPLAY; not in combination with F6, D6, F7)	-			T8			-
Light module warm white 2,700 K: light strips arranged on the side walls of the interior, 10 strips for model 110, 14 for model 260/400/750, programme-controlled dimming from 0 to 100 % (in 1 % steps), ramp programming in combination with temperature (only with TwinDISPLAY; not in combination with D6, F6, F7)	-			T9			-
Interior socket, ampacity 230 V/2.2 A, can be switched off with the On/Off switch, cannot be switched individually, moisture tight IP68	R3						
Interior socket (can only be ordered with limited temperature range - max. +70 °C), ampacity 230 V/2.2 A, can be switched on/off via tumbler switch in control panel, moisture tight IP68	R4						
Entry port, 23 mm clear diameter, for introducing connections at the side, can be closed by flap, standard positions (F0 and F2 not for model size 260 with light module; F0 - F3 not for model size 110 with light module)	left centre/centre			F0			
	left centre/top			F1			
	right centre/centre			F2			
	right centre/top			F3			
Entry port, 23 mm clear diameter, can be closed by flap (please, state location)	left			F4			
	right			F5			
	rear			F6			
Entry port, 14 mm clear diameter, can be closed by flap, in special positions in the back wall (please, state location; not in combination with T7, T8, T9)	D6						
Entry port, 38 mm clear diameter, can be closed by flap, in special positions in the back wall (please, state location; not in combination with T7, T8, T9)	F7						
4 - 20 mA current loop interface (-10 to +80 °C = 4 - 20 mA)	Temperature controller, actual value			V3			
	Temperature of a Pt100 sensor positioned flexibly in chamber for external temperature monitoring (max. 1 SingleDISPLAY, max. 3 TwinDISPLAY) - price per sensor			V6			
Works calibration certificate for 3 temperatures: +5 °C, +37 °C, +60 °C	D00129						
Works calibration certificate for one (freely selectable) temperature value according to customer specification	D00109						
Door with lock and key (safety lock)	B6						
Door hinged on the left	B8						
Potential-free contact (24 V/2 A) with socket, according to NAMUR NE 28 for external monitoring (indicates when setpoint is reached)	H5						
Potential-free contact for combination error message (e.g. supply failure, sensor fault, fuse)	H6						
Potential-free contact (24 V/2 A) with socket to NAMUR NE 28, for signal generation, controlled by programme segment, for free-selectable functions to be activated (e.g. activation of audible and visual signals, exhaust motors, fans, stirrers, etc.). Only for units with TwinDISPLAY	2 contacts		H72				
Process-dependent programmable door lock (only for units with TwinDISPLAY)	D4						
Door-open-recognition (only for units with TwinDISPLAY)	V5						
Flexible Pt100 for positioning in chamber or in load with socket, 4-pin, according to NAMUR NE 28, for external temperature recording (load temperature) max. 3 sensors	H4						
Flexible Pt100 temperature sensor, positioned flexibly in chamber or load, for local temperature measurement (up to 3 additional sensors are possible). The measured temperature can, if required, be indicated on the display, recorded in the integral data store, and can be documented via the AtmoCONTROL software	H8						
MobileALERT, notification by SMS in case of any error or alarm of the device. Requires option H6	C3						
Castor frame (2-part), height 140 mm	R9						

Accessories	30	55	110	260	410	750	1060
Stainless steel grid, electropolished	E28884	E20164	E20165		E28891	E20182	B41251

Accessories	30	55	110	260	410	750	1060
Additional reinforced stainless steel grid, electropolished, max. loading 60 kg; size 750 with guide bars and fixing screws (only in connection with option K1). Please consider max. loading of chamber	-		E29767	E29766	B32190	B32550	
Perforated stainless steel shelf	B29727	B03916	B00325	B29725	B00328	B32549	
Additional reinforced stainless steel shelf, max. loading 60 kg; with guide bars and fixing screws (only in connection with option K1). Please consider max. loading of chamber	-				B32191	-	
Stainless steel slide-in drip tray, 15 mm rim (may affect the temperature distribution) - cannot be used in connection with option K1	E02070	E02072	E02073	E29726	E02075	B32599	
Stainless steel slide-in drip tray, 15 mm rim, with guide bars and fixing screws (may affect the temperature distribution) - can be used only in connection with option K1	-				B32763	-	
Stainless steel bottom drip tray, 15 mm rim (may affect the temperature distribution) - cannot be used in connection with option K1	B04356	B04358	B04359	B29722	B04362	B29769	
Stainless steel bottom drip tray, 15 mm rim (may affect the temperature distribution) - can be used only in connection with option K1	-				B34055	-	
Guarantee extension by 1 year	GA1Q5			GA2Q5		GA4Q5	
USB-Ethernet adapter				E06192			
Ethernet connection cable 5 m for computer interface				E06189			
USB User-ID stick (with User-ID licence): Oven-linked authorisation licence (User-ID-programme) on Memory-stick, prevents undesired manipulation by unauthorised third parties. When reordering please specify serial number (only for units with TwinDISPLAY)				B33170			
USB stick with documentation software AtmoCONTROL and operation manual for products with SingleDISPLAY (the standard equipment of appliances with TwinDISPLAY includes one USB stick with AtmoCONTROL). When reordering please specify serial number				B33172			
Set of height adjustable feet (4 pcs)	B29768					-	
Stacking set (4 pcs) for stacking of appliances of same size	B29744					-	
Flush-fit unit (stainless steel frame covering gap between oven and wall opening), with air slots	B29728	B29730	B29734	B29738	B42116	B29742	
Flush-fit unit (stainless steel frame covering gap between oven and wall opening), without air slots	B29729	B29731	B29735	B29739	B42117	B29743	
Subframe, adjustable in height (size 30 and 55: height 600 mm, size 110 and 260: height 500 mm)	B29745	B29747	B29749	B29751			-
Subframe, on castors (size 30 and 55: height 660 mm, size 110: height 560 mm)	B29746	B29748	B29750			-	
Subframe, adjustable in height, height 130 mm, for example for units with fresh air filter	B33657	B33659	B33661	B33664			-
Software conforming to FDA AtmoCONTROL. Meets the requirements for the use of electronically stored data sets and electronic signatures as laid down in Regulation 21 CFR Part 11 of the US Food and Drug Administration (FDA). Base licence for the control of one unit (only for units with TwinDISPLAY). Respective IQ/OQ documents available in German and English language (without surcharge)				FDAQ1			
Integration of one additional unit (up to max. 15 units) into an already existent FDA-software licence (only for units with TwinDISPLAY)				FDAQ2			
IQ document with device-specific works test data, OQ/PQ check list as support for validation by customer				D00124			
IQ/OQ document with device-specific works test data for one free-selectable temperature value, incl. temperature distribution survey at Memmert for 9 measuring points (size 30), 27 measuring points (sizes 55 - 1060) to DIN 12880:2007-05. PQ check list as support for validation by customer. 305 € for further temperature values and validation at customer site on demand (GER, AT, CH only)	D00125	D00127					
External measuring instrument with sensors for daylight and UV-light. Product information on demand (models IPPplus)				B04713			-
External measuring instrument with additional measuring head for temperature and humidity measurement. Product information on demand (models IPPplus)				B04714			-



Cooled storage incubator IPS
with SingleDISPLAY
AtmoCONTROL software

Model sizes: 260 / 750
+14 °C to +45 °C

COOLED STORAGE INCUBATOR IPS Save energy and reduce the strain on the climate at the same time! If microbiological cultures, BOB5 samples, drinks containers or cosmetics need to be stored over a long period at constant temperatures, cooled storage incubators IPS with energy-efficient Peltier technology are the perfect choice: absolute reliability, precision, durability and eco-friendliness.



Considerable potential for savings in acquisition and operating costs

Temperature changes are not always necessary for long-term storage or incubating. So why design heating, cooling and controlling systems for rapid heating up and cooling down times? The performance of the IPS was tailor-made for permanent operation at constant temperatures close to room temperature. The advantage: Acquisition costs and operating costs are considerably reduced in comparison to conventional cooled incubators with compressor technology, as well as to a large Peltier-cooled incubator.



Ideal for high ambient temperatures

Thanks to Peltier elements integrated for cooling the working chamber, the chamber load won't break into sweat even at high ambient temperatures. Constant and precise incubation at room temperature is guaranteed.



Low in vibration and durable for absolutely safe long-term storage

Like the cooled incubator IPP, the IPS offers all the advantages of Peltier technology to the user. Its interior chamber that is completely insulated from the environment minimises the risk of drying out of the samples. It is practically noise-free and not only reduces stress on the chamber load but also soothes the nerves of employees thanks to its quiet operation.



Glimpse into a Memmert storage incubator: Peltier elements guarantee perfect climate inside the chamber.



COOLED STORAGE INCUBATORS IPS

according to DIN 12880:2007-05, EN 61010-1 (IEC 61010-1), EN 61010-2-010

Standard units are safety-approved and bear the test marks:



- Interior: Stainless steel, material 1.4301 (ASTM 304), deep-drawn
- Housing: Textured stainless steel, rear zinc-plated steel, intuitively operated SingleDISPLAY (TFT colour display) with touchscreen
- Double doors: Outside stainless steel, fully insulated, inside glass (size 750 two leaves)
- Connection: Mains cable with plug (German type)
- Installation: 4 feet; size 750 mounted on lockable castors
- Interfaces:

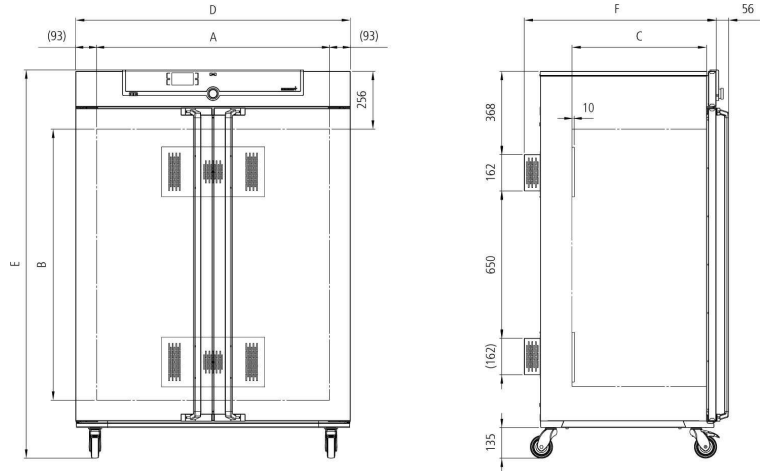

Model sizes/Description			260	750
Stainless steel interior	Volume	approx. l	256	749
	Width	(A) mm	640	1040
	Height	(B) mm	800	1200
	Depth (less 10 mm for fan – Peltier)	(C) mm	500	600
	Max. number of grids/shelves	number	9	14
	Max. loading per grid/shelf	kg	20	30
	Max. loading of chamber	kg	200	
	Max. loading per slide-in drip tray	kg	4	8
Textured stainless steel exterior	Max. loading per bottom drip tray	kg	4	8
	Width	(D) mm	824	1224
Standard equipment	Height (size 750 with castors)	(E) mm	1183	1720
	Depth (without door handle), door handle + 56 mm	(F) mm	754	856
Temperature	Standard equipment	number	2	
	Working temperature range	°C	+18 and +25	
	Setting temperature range	°C	+14 to +45	
Further data	Setting accuracy	°C	0.1	
	Electrical load at 230/115 V, 50/60 Hz	approx. W	550	
	Peltier elements in the rear	number	2	
Packing data	Net weight	approx. kg	113	230
	Gross weight (packed in carton)	approx. kg	164	301
	Width	approx. mm	930	1330
	Height	approx. mm	1380	1910
	Depth	approx. mm	930	1050
Order No. Cooled Storage Incubators			IPS260	IPS750

Options	260	750
Voltage 115 V, 50/60 Hz		X2
Chamber modification for the application of reinforced perforated stainless steel shelves or stainless steel grids (bearing rails mounted in the working chamber) - includes replacement of standard grids by reinforced grids	-	K1
Interior socket, ampacity 230 V/2.2 A, can be switched off with the On/Off switch, cannot be switched individually, moisture tight IP68		R3
Interior socket (can only be ordered with limited temperature range - max. +70 °C), ampacity 230 V/2.2 A, can be switched on/off via tumbler switch in control panel, moisture tight IP68		R4
Entry port, 23 mm clear diameter, for introducing connections at the side, can be closed by flap, standard positions	left centre/centre	F0
	left centre/top	F1
	right centre/centre	F2
	right centre/top	F3
Entry port, 23 mm clear diameter, can be closed by flap, in special positions (please state location)	left	F4
	right	F5
	rear	F6
Entry port, 14 mm clear diameter, can be closed by flap, in special positions in the back wall (please, state location)		D6
Entry port, 38 mm clear diameter, can be closed by flap, in special positions in the back wall (please, state location)		F7
4 - 20 mA current loop interface (0 to +70 °C = 4 - 20 mA)	Temperature controller, actual value	V3
	Temperature of a Pt100 sensor positioned flexibly in chamber for external temperature monitoring	V6
Works calibration certificate for one (freely selectable) temperature value according to customer specification		D00109
Door with lock and key (safety lock)		B6
Door hinged on the left	B8	-
Potential-free contact (24 V/2 A) with socket, according to NAMUR NE 28 for external monitoring (indicates when setpoint is reached)		H5
Potential-free contact for combination error message (e.g. supply failure, sensor fault, fuse)		H6
Flexible Pt100 for positioning in chamber or in load with socket, 4-pin, according to NAMUR NE 28, for external temperature recording (load temperature) max. 3 sensors		H4
Flexible Pt100 temperature sensor, positioned flexibly in chamber or load, for local temperature measurement (up to 3 additional sensors are possible). The measured temperature can, if required, be indicated on the display, recorded in the integral data store, and can be documented via the AtmoCONTROL software		H8
MobileALERT, notification by SMS in case of any error or alarm of the device. Requires option H6		C3
Castor frame (2-part), height 140 mm	R9	-

Accessories	260	750
Stainless steel grid, electropolished	E28891	E20182
Additional reinforced stainless steel grid, electropolished, max. loading 60 kg; size 750 with guide bars and fixing screws (only in connection with option K1). Please consider max. loading of chamber	E29766	B32190
Perforated stainless steel shelf	B29725	B00328
Additional reinforced stainless steel shelf, max. loading 60 kg; with guide bars and fixing screws (only in connection with option K1). Please consider max. loading of chamber	-	B32191
Stainless steel slide-in drip tray, 15 mm rim (may affect the temperature distribution) - cannot be used in connection with option K1	E29726	E02075
Stainless steel slide-in drip tray, 15 mm rim, with guide bars and fixing screws (may affect the temperature distribution) - can be used only in connection with option K1	-	B32763
Stainless steel bottom drip tray, 15 mm rim (may affect the temperature distribution) - cannot be used in connection with option K1	B29722	B04362
Stainless steel bottom drip tray, 15 mm rim (may affect the temperature distribution) - can be used only in connection with option K1	-	B34055
Guarantee extension by 1 year		GA2Q5
USB-Ethernet adapter		E06192
Ethernet connection cable 5 m for computer interface		E06189
USB stick with documentation software AtmoCONTROL and operation manual. When reordering please specify serial number		B33172
Set of height adjustable feet (4 pcs)	B29768	-
Flush-fit unit (stainless steel frame covering gap between oven and wall opening), with air slots	B29738	B29742
Flush-fit unit (stainless steel frame covering gap between oven and wall opening), without air slots	B29739	B29743
Subframe, adjustable in height (height 500 mm)	B29751	-
Subframe, adjustable in height, height 130 mm, for example for units with fresh air filter	B33664	-
IQ document with device-specific works test data, OQ/PQ check list as support for validation by customer		D00124
IQ/OQ document with device-specific works test data for one free-selectable temperature value, incl. temperature distribution survey at Memmert for 27 measuring points to DIN 12880:2007-05. PQ check list as support for validation by customer. 305 € for further temperature values and validation at customer site on demand (GER, AT, CH only)		D00127

MODEL VARIANTS

SingleDISPLAY ControlCOCKPIT with one TFT display	TwinDISPLAY ControlCOCKPIT with two TFT displays
AVAILABLE APPLIANCES UN/UNm / UF/UFm / IN/INm / IF/IFm / IFbw / SN / SF / IPP / IPS	AVAILABLE APPLIANCES UNplus/UNmplus / UFplus/UFmplus / UF TS / UNpa INplus/INmplus / IFplus/IFmplus / SNplus / SFplus / VO IComed / IPPplus / ICPeco / ICP / HPP / ICHeco / ICH / HCP
One high-resolution TFT colour display with touch-sensitive buttons for selection of functions	Two high-resolution TFT colour displays with touch-sensitive buttons for selection of functions
Available parameters on the ControlCOCKPIT: Temperature (Celsius or Fahrenheit), fan speed, exhaust air flap position, programme time	Available parameters on the ControlCOCKPIT: Temperature (Celsius or Fahrenheit), fan speed, exhaust air flap position, programme time, relative humidity, illumination, CO ₂
One temperature sensor Pt100 DIN class A in a 4-wire circuit	Two Pt100 sensors DIN class A in a 4-wire circuit for mutual monitoring, taking over functions in case of an error
	HeatBALANCE function for application specific adjustment of heat output distribution (balance) between the upper and lower heating groups in an adjustment range between -50 % and +50 % (not valid for models 30, HPP110, IPP110plus, ICP, ICH)
AtmoCONTROL software for reading out, managing and organising the data logger via Ethernet interface (temporary trial version can be downloaded). USB stick with AtmoCONTROL software available as accessory (on demand)	AtmoCONTROL software on a USB stick for programming, managing and transferring programmes via Ethernet interface or USB port
	ControlCOCKPIT with USB port for uploading programmes, reading out protocol logs, activating the User-ID function
	Displaying of already logged protocol data on the ControlCOCKPIT (max 10,000 values correspond to approx. 1 week)
Ethernet interface on the rear of the appliance for reading out the protocol log and for online logging	Ethernet interface on the rear of the appliance for reading out the protocol log and for uploading programmes and for online logging
Double overtemperature protection: Electronic temperature monitoring with freely adjustable monitoring temperature, for models U, I, S with option A6 TWW/TWB (protection class 3.1 or 2), mechanical temperature limiter TB acc. to DIN 12880	Multiple overtemperature protection: Electronic temperature monitoring TWW/TWB (protection class 3.1 or 2 resp. 3.3 for units with active cooling) and mechanical temperature limiter TB (protection class 1) acc. to DIN 12880, AutoSAFETY automatically adjusts to the set value within a freely adjustable tolerance range. Setting individual MIN / MAX values for over/undertemperature and also for all other parameters such as relative humidity, CO ₂
PID microprocessor control with integrated auto-diagnostic system	
Structured stainless steel housing, scratch-resistant, robust and durable; rear of zinc-plated steel	
High-temperature connectors on the rear of the appliance for single-phase power connection according to country specific systems and IEC standards	
Internal data logger with a storage capacity of at least 10 years	
German, English, French, Spanish, Polish, Czech, Hungarian language settings available on the ControlCOCKPIT	
Digital backwards counter with target time setting, adjustable from 1 minute to 99 days	
The SetpointWAIT function guarantees that the process time does not start until the set temperature is reached at all measuring points – optional for temperature values recorded by the freely positionable Pt100 sensors inside the chamber	
Adjustment of three calibration values for temperature and additional appliance specific parameters directly at the ControlCOCKPIT	

SOFTWARE AtmoCONTROL

AtmoCONTROL

The innovative control and logging software

Parameters such as temperature and humidity as well as the process time can be set directly at the ControlCOCKPIT. Ramp programming is done via the control and logging software AtmoCONTROL, which features a completely new software design.

Drag, drop & go!

Numerical and graphic programming of complex processes is a thing of the past. Today, programming is done via AtmoCONTROL by means of the mouse or touchpad on your notebook. Even the most complex ramp programmes are created within minutes. Simply drag & drop the graphical symbols for the desired parameters to the input field and change the values according to your wishes with a mouse click.

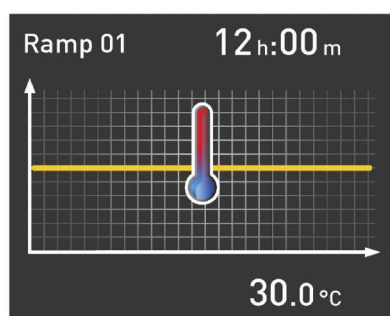

Programme functions for appliances with SingleDISPLAY and TwinDISPLAY

- Reading out, managing and organising the data logger
- Saving the log memory in various formats
- Online monitoring of up to 32 connected appliances
- Optical alarms when the alarm limits individually set at the ControlCOCKPIT are exceeded
- Automatic alarm to one or several e-mail addresses

Additional functions for appliances with TwinDISPLAY

- Intuitive programming and archiving of ramps and programme sequences
- Synchronous visualisation of the created programme sequence during programming
- Application-specific repeat functions (loops) can be inserted within a temperature control programme in any place
- Simple creation of repeating weekly programmes
- Programming, managing and transferring programmes via Ethernet interface or USB port

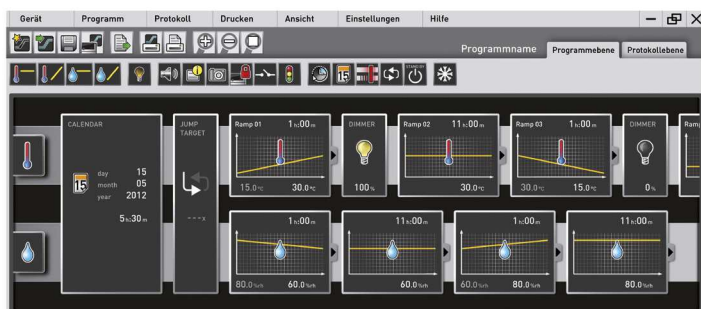



Customisation department as a "development assistant"



Customisation department

Memmert myAtmoSAFE meets any specific customer demand.

The customisation department adapts standard appliances to special needs. Their solutions are economic as well as technologically advanced and customers profit from the full guarantee period. Some customer-specific development projects, such as special model sizes 400, 1400 and 2200 of the HPP even made their way into the standard product range.

If users want to make sure they chose the right appliance offering the right suit of parameters and functions, they can have their application tested in advance in the Memmert MPTC Test Centre.

Customer-specific adjustment of standard models:

- Feed-throughs and ducts
- Special fittings for special applications (e.g. weighing equipment)
- Limiting temperatures in the heating and cooling range
- Air exchange rates
- Relative humidity
- (Wall) Frames
- Telescopic trays
- Heavy duty appliances, heavy duty bottom grids
- Special bases, stacking frames
- Central or integrated water supply
- Special model sizes
- Appliances for integration in the production lines



HEATING AND DRYING OVENS

UNIVERSAL OVEN U

PASS-THROUGH OVEN UF TS

PARAFFIN OVEN UNpa

STERILISER S

VACUUM OVEN VO

BLANKET WARMER IFbw

INCUBATORS

INCUBATOR I

CO₂ INCUBATOR ICOmed

COMPRESSOR-COOLED INCUBATOR ICPeco/ICP

PELTIER-COOLED INCUBATOR IPP

COOLED STORAGE INCUBATOR IPS

CLIMATE CHAMBERS

CONSTANT CLIMATE CHAMBER HPP

HUMIDITY CHAMBER HCP

CLIMATE CHAMBER ICHeco/ICH

ENVIRONMENTAL TEST CHAMBER CTC/TTC

WATERBATHS / OILBATHS

WATERBATH W

OILBATH O

YOUR MEMMERT PARTNER

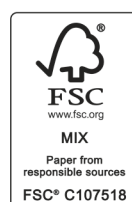

Memmert GmbH + Co. KG
P.O. Box 1720 | D-91107 Schwabach
Tel. +49 9122 925-0 | Fax +49 9122 14585
E-Mail: sales@memmert.com
facebook.com/memmert.family
instagram.com/memmert.family
The platform for experts: www.atmosafe.net