

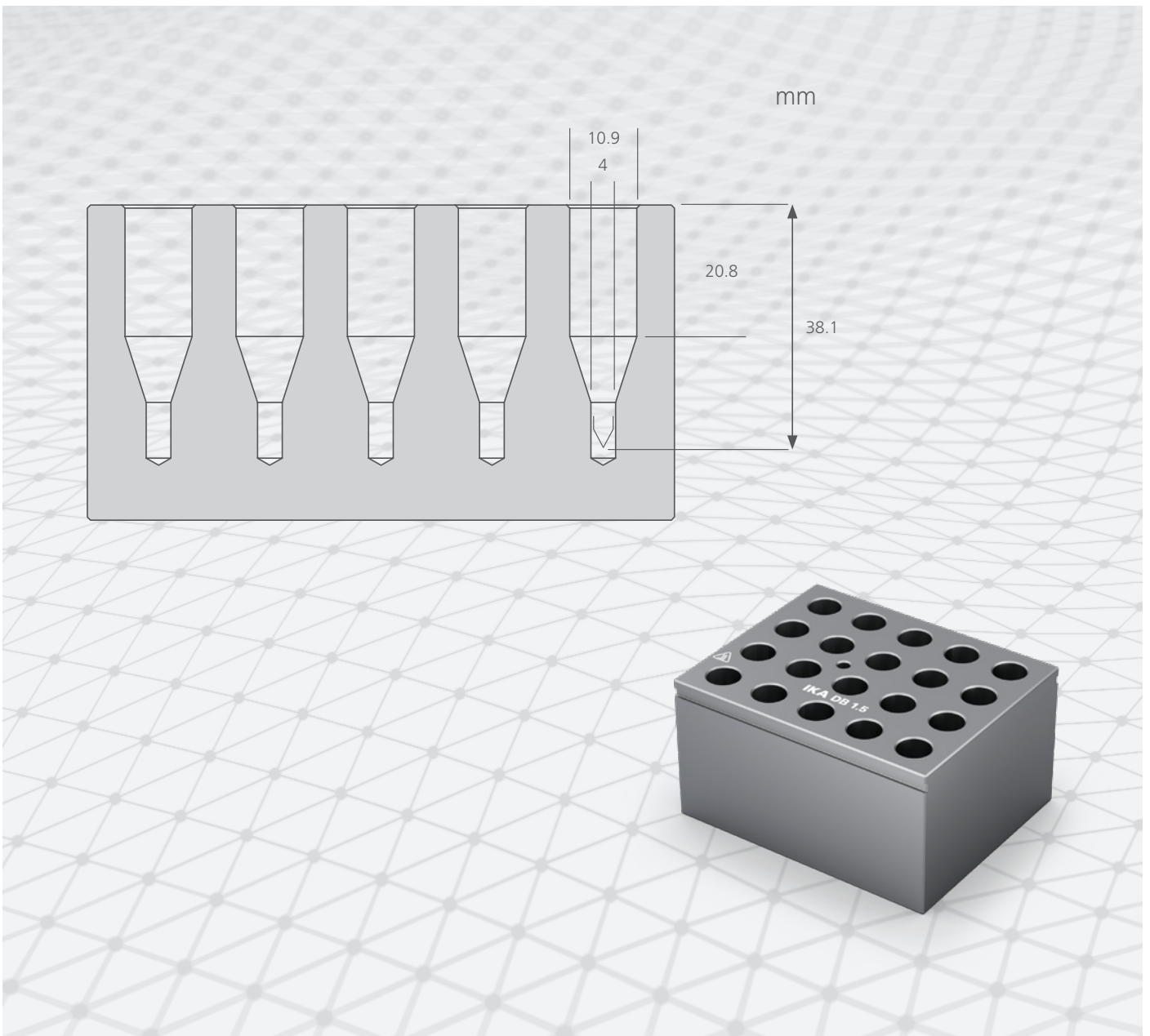

designed for scientists

EN



Overview | [Heating block geometries](#)

# Heating blocks

DB 1



DB 1.1 | 3

DB 2



DB 2.1 | 8

DB 3



DB 3.1 | 10

DB 4



DB 4.1 | 13

DB 5



DB 5.1 | 22

DB 6



DB 6.1 | 31



DB 1.2 | 4



DB 2.2 | 9



DB 3.2 | 11



DB 4.2 | 14



DB 5.2 | 23



DB 6.2 | 32



DB 1.3 | 5



DB 3.3 | 12



DB 4.3 | 15



DB 5.3 | 24

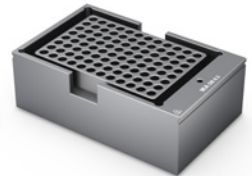

DB 6.3 | 33



DB 1.4 | 6



DB 4.4 | 16



DB 5.4 | 25



DB 1.5 | 7



DB 4.5 | 17



DB 5.5 | 26



DB 4.6 | 18



DB 5.6 | 27



DB 4.7 | 19



DB 5.7 | 28



DB 4.8 | 20



DB 5.8 | 29



DB 4.9 | 21



DB 5.9 | 30

DB 7



DB 7.1 | 34

DB 8



DB 8.1 | 35

# Heating Block DB 1.1



# Heating Block DB 1.2



# Heating Block DB 1.3



# Heating Block DB 1.4

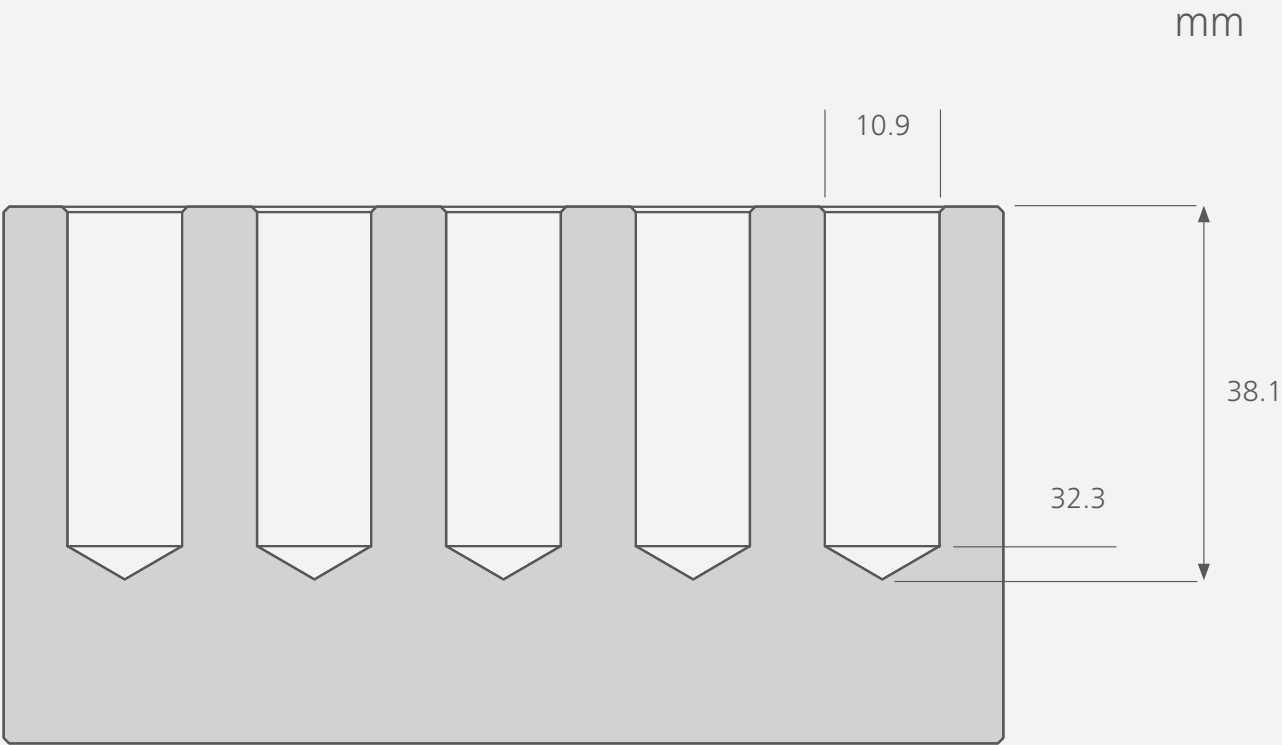

# Heating Block DB 1.5

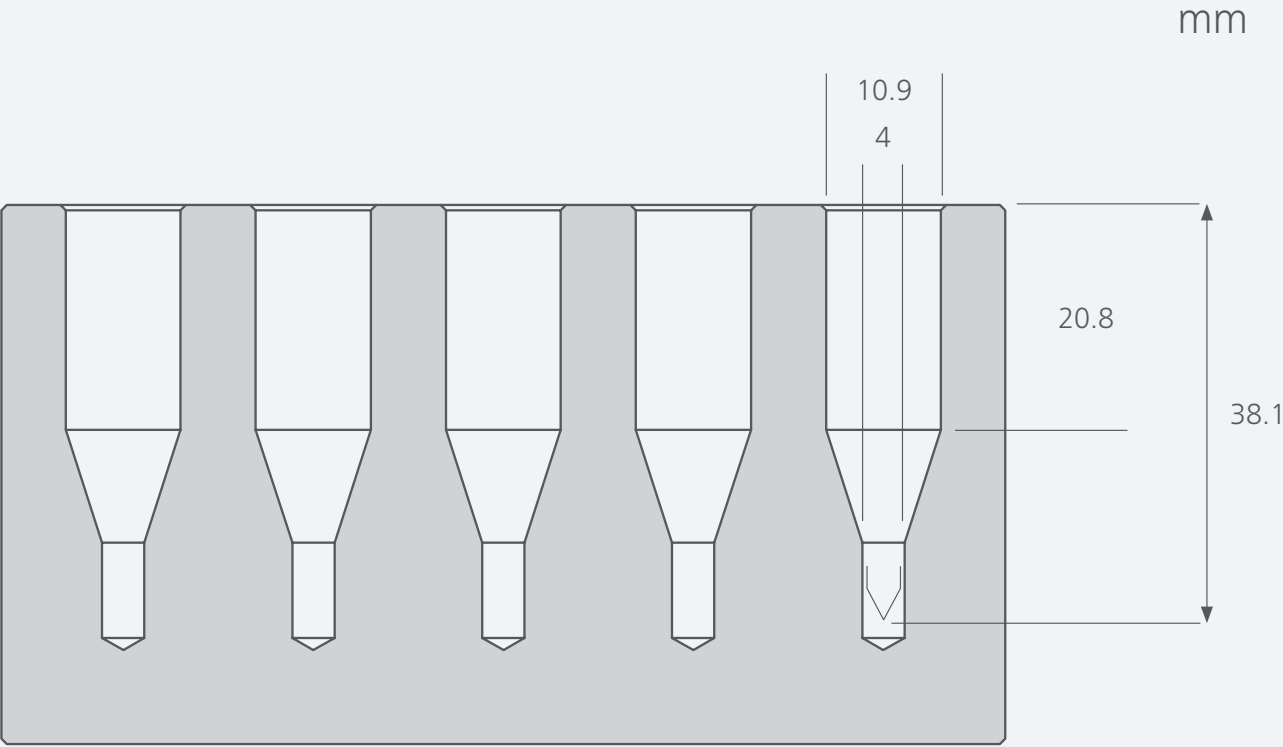

# Heating Block DB 2.1





# Heating Block DB 2.2



mm

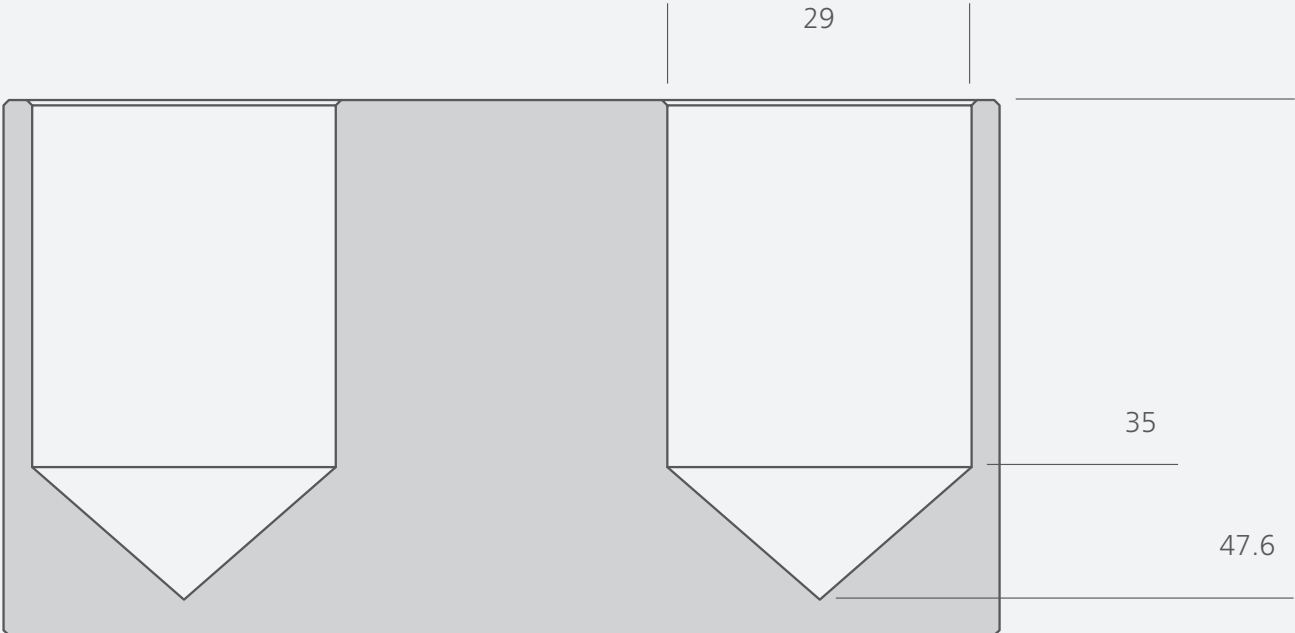

# Heating Block DB 3.1



A-A (1:1)



B-B (1:1)



C-C (1:1)

# Heating Block DB 3.2

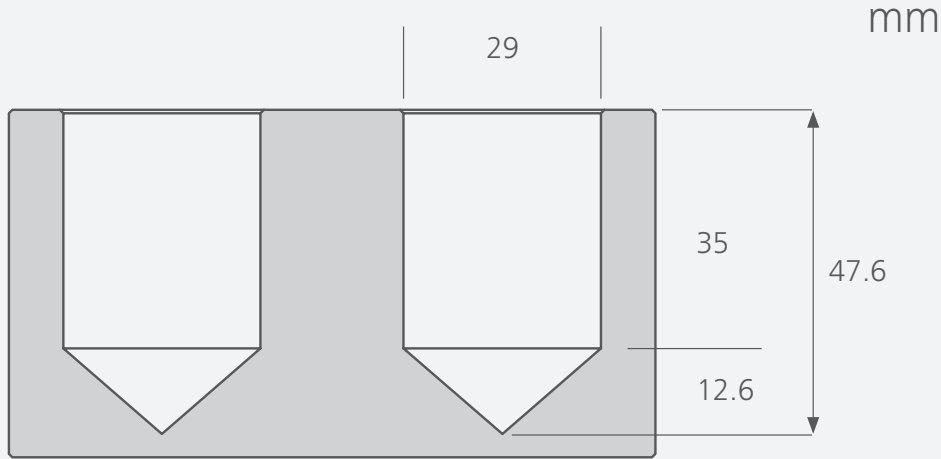

A-A (1:1)

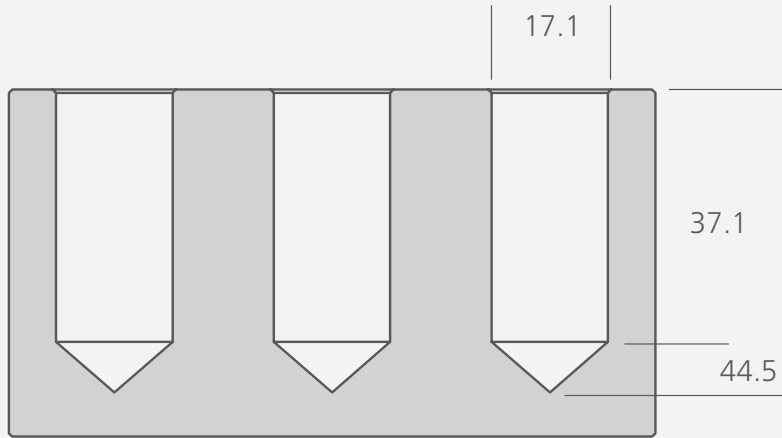

B-B (1:1)

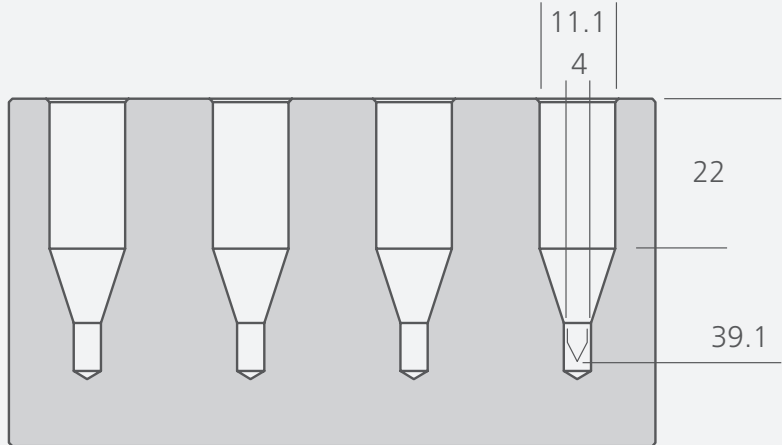

C-C (1:1)

# Heating Block DB 3.3

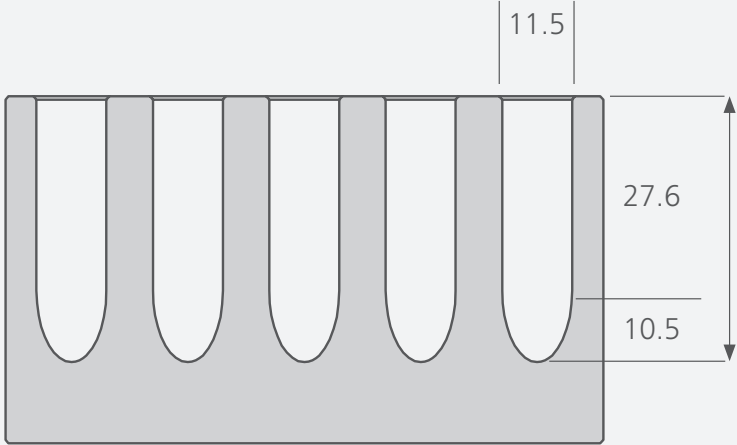
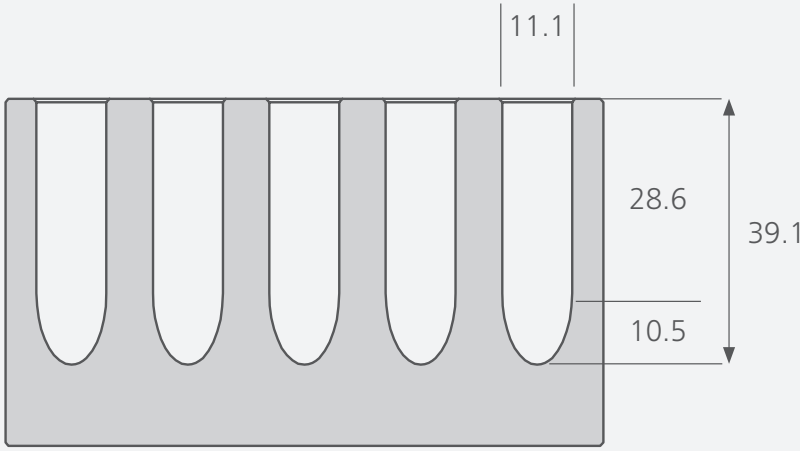
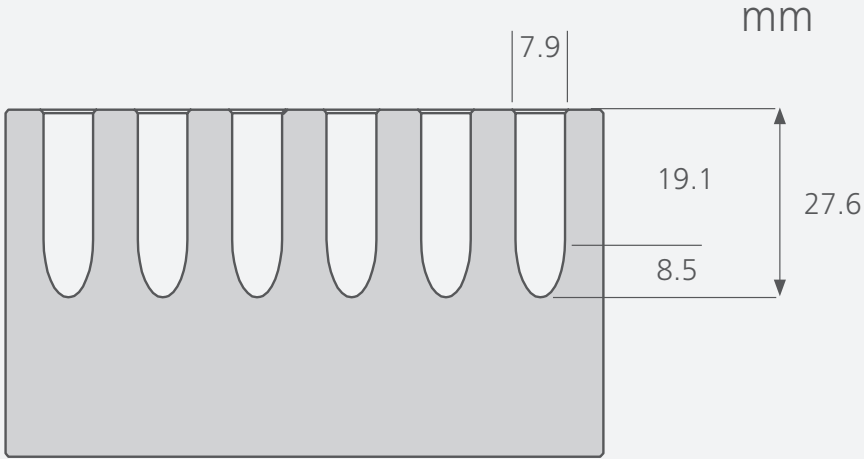
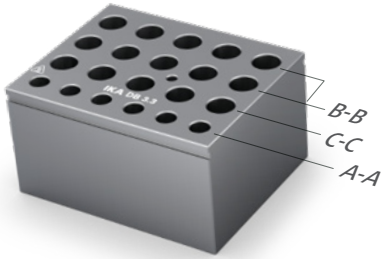

# Heating Block DB 4.1



mm

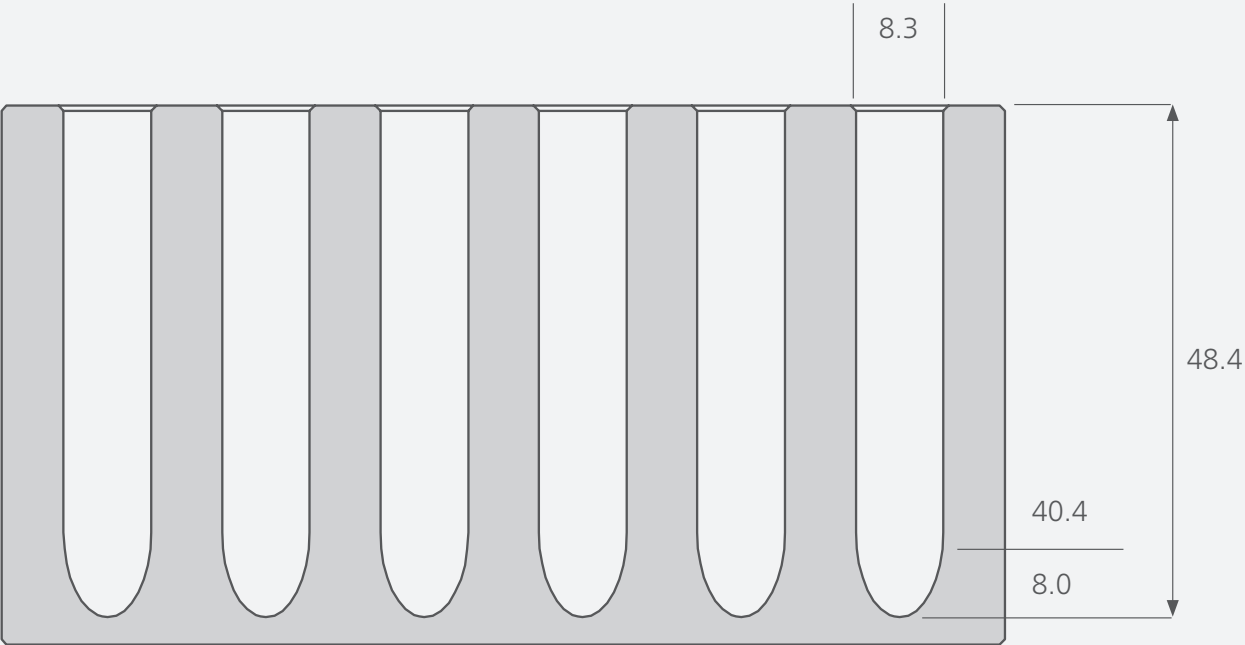

# Heating Block DB 4.2

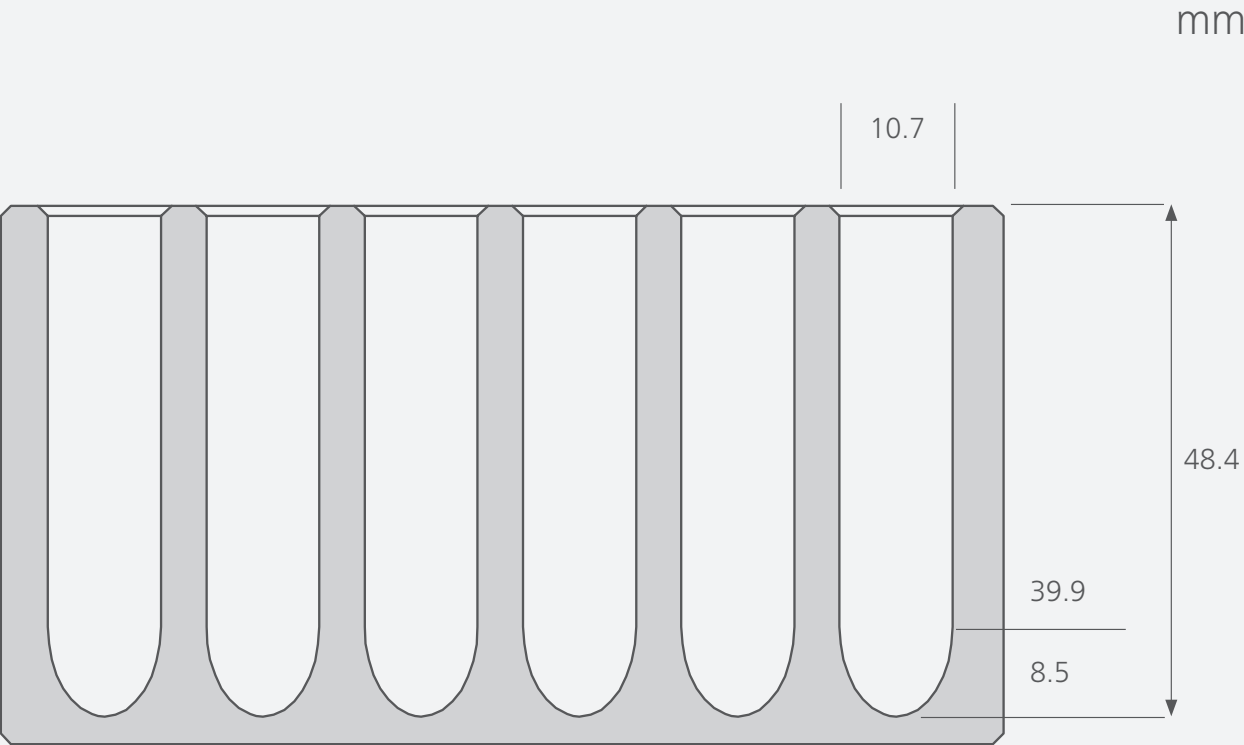

# Heating Block DB 4.3

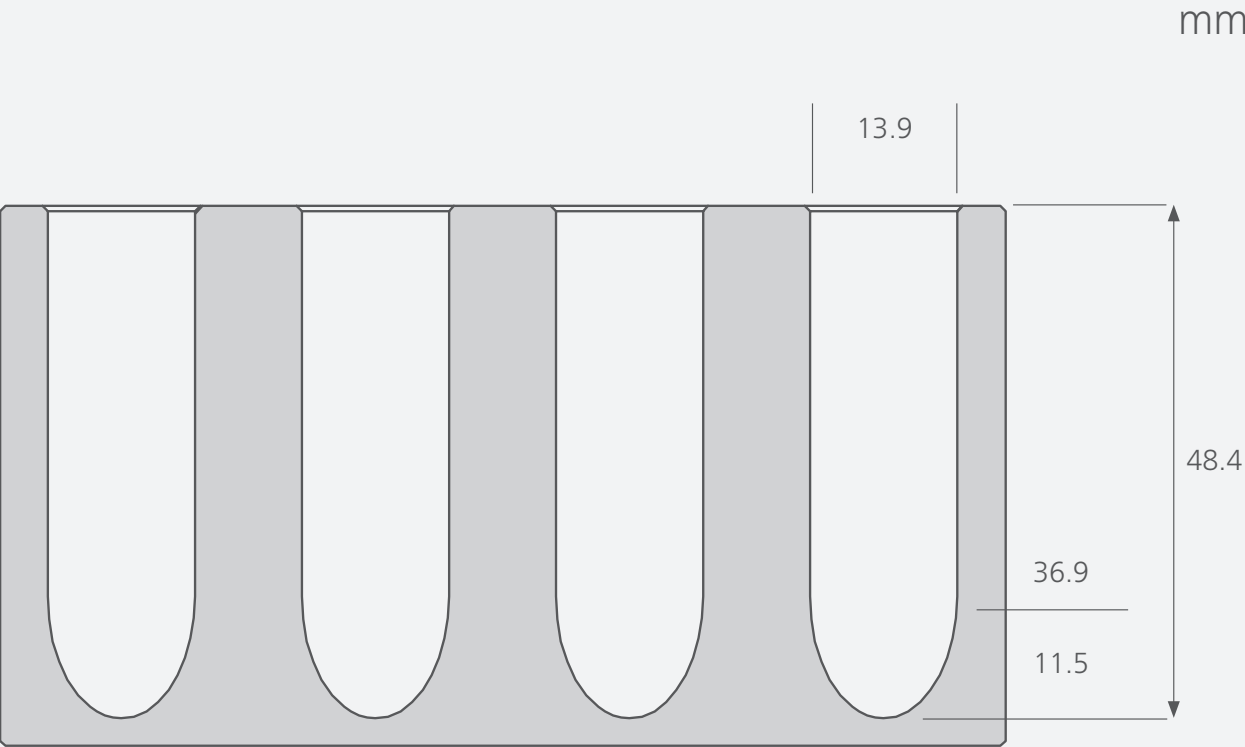

# Heating Block DB 4.4

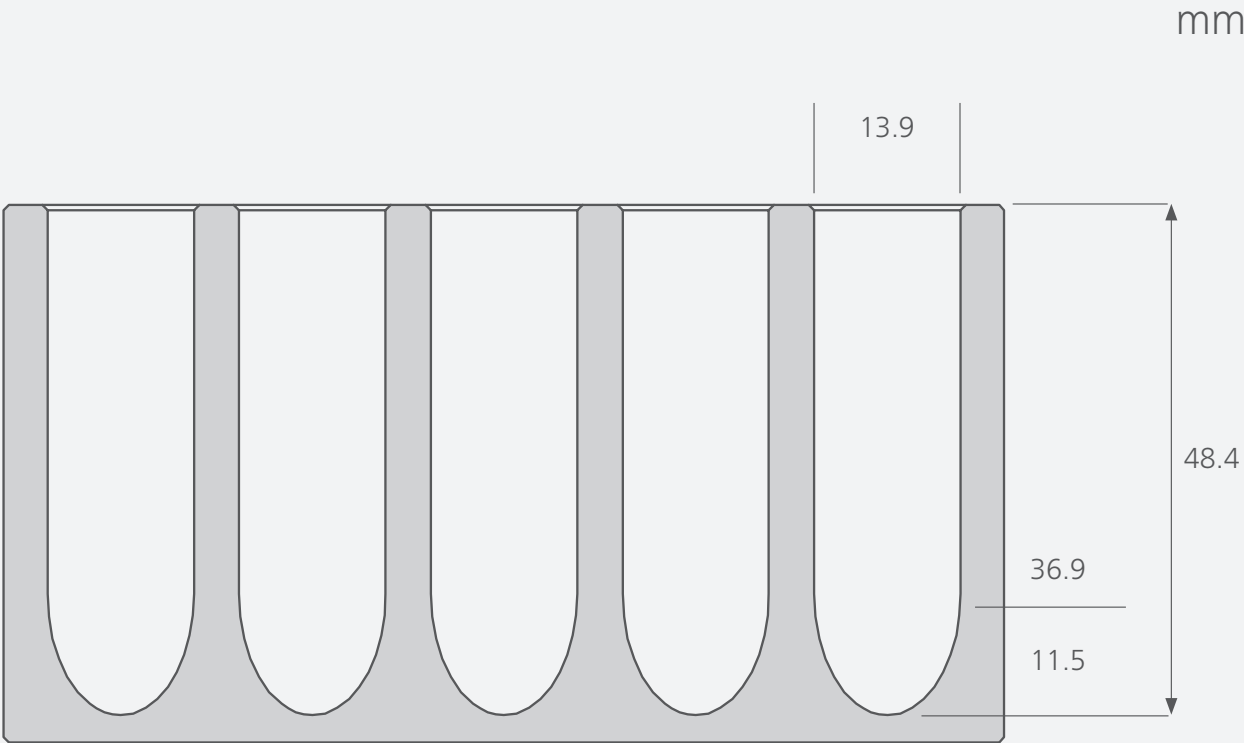



# Heating Block DB 4.5

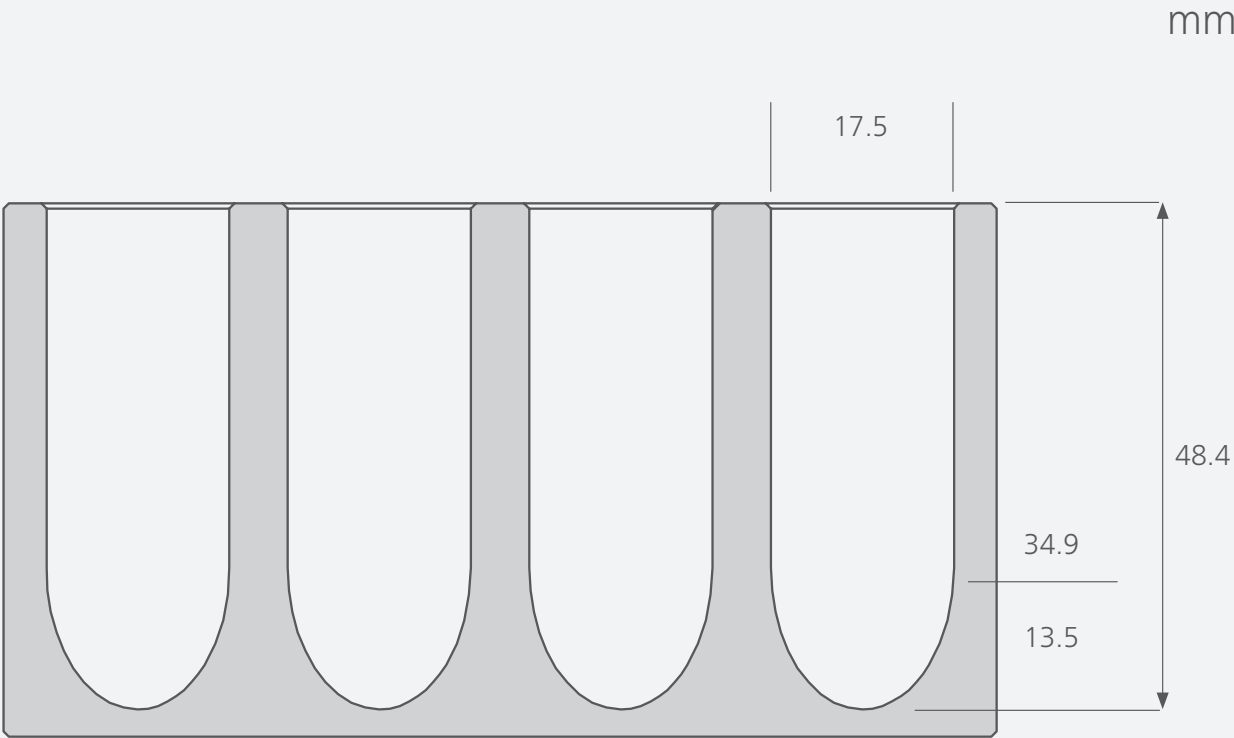

# Heating Block DB 4.6

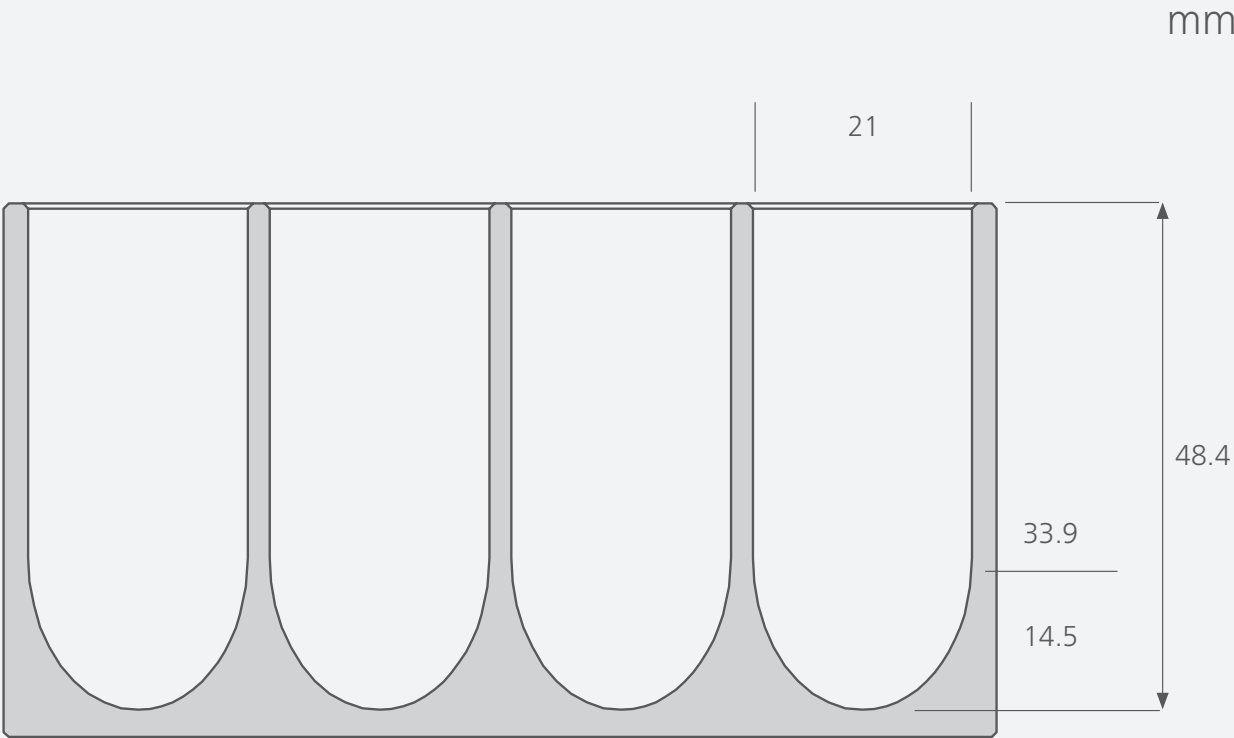

# Heating Block DB 4.7

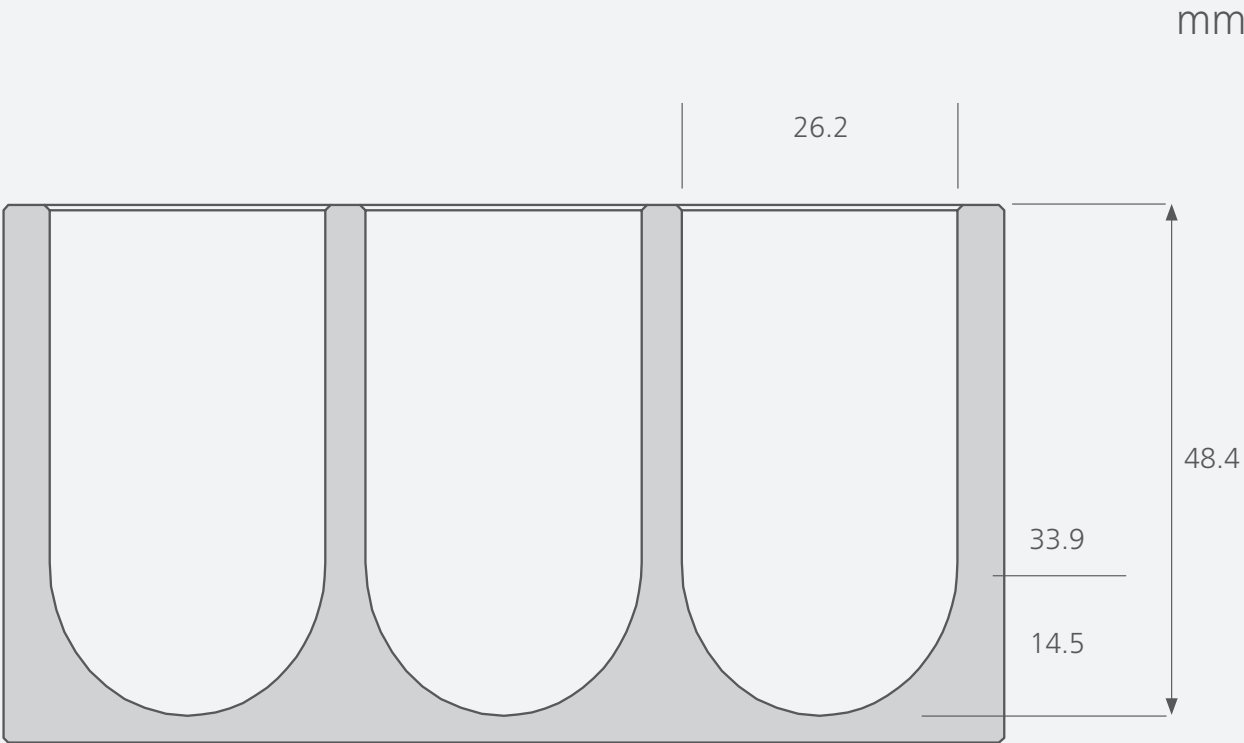

# Heating Block DB 4.8

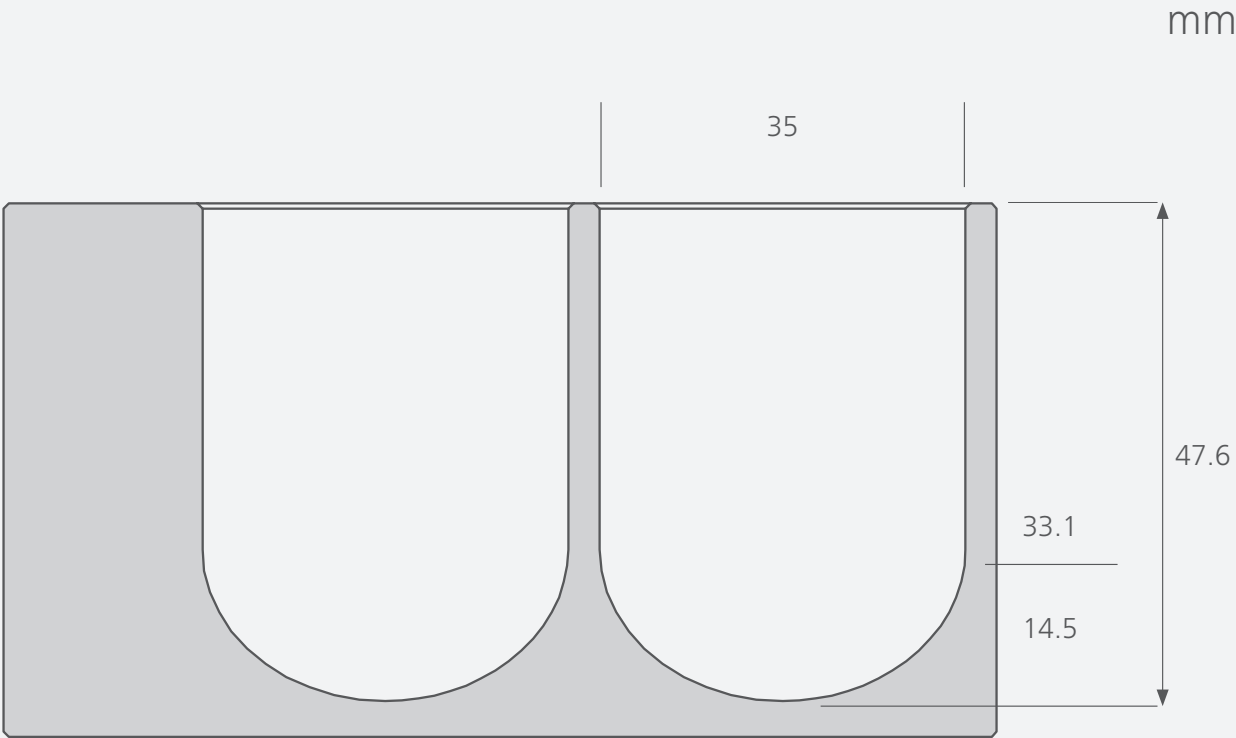

# Heating Block DB 4.9

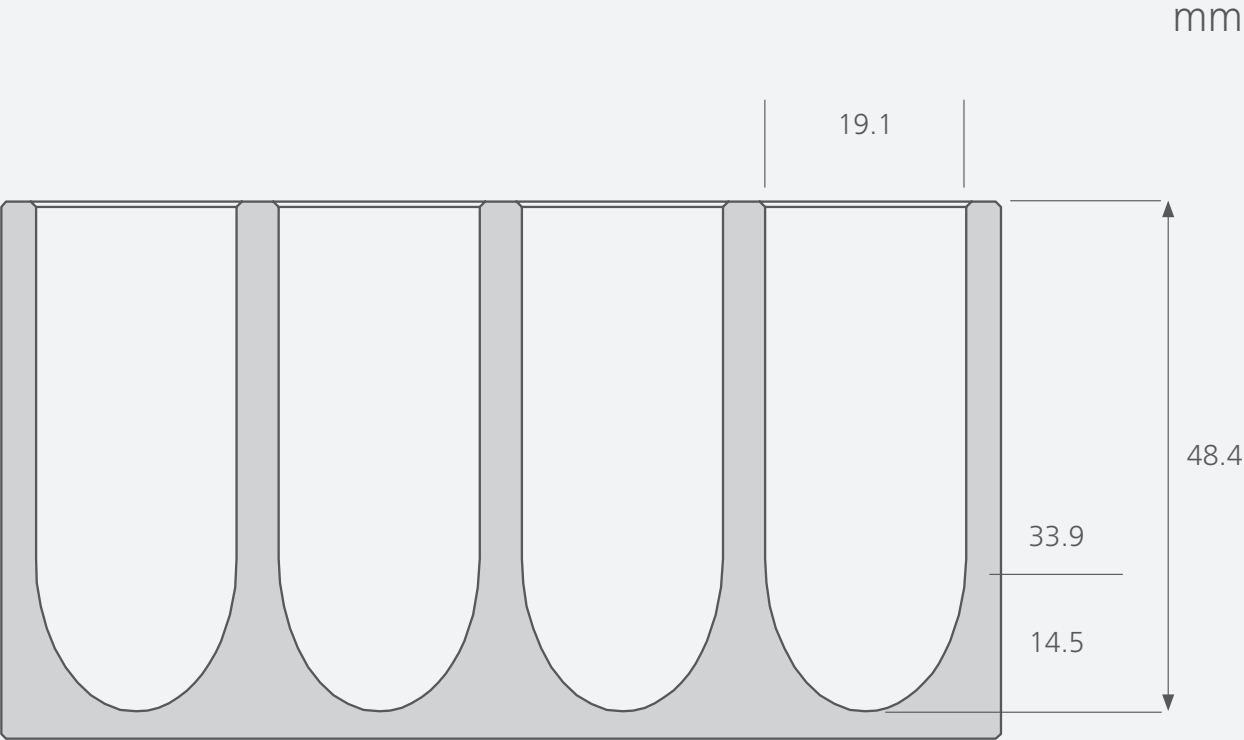

# Heating Block DB 5.1



mm



# Heating Block DB 5.2



mm

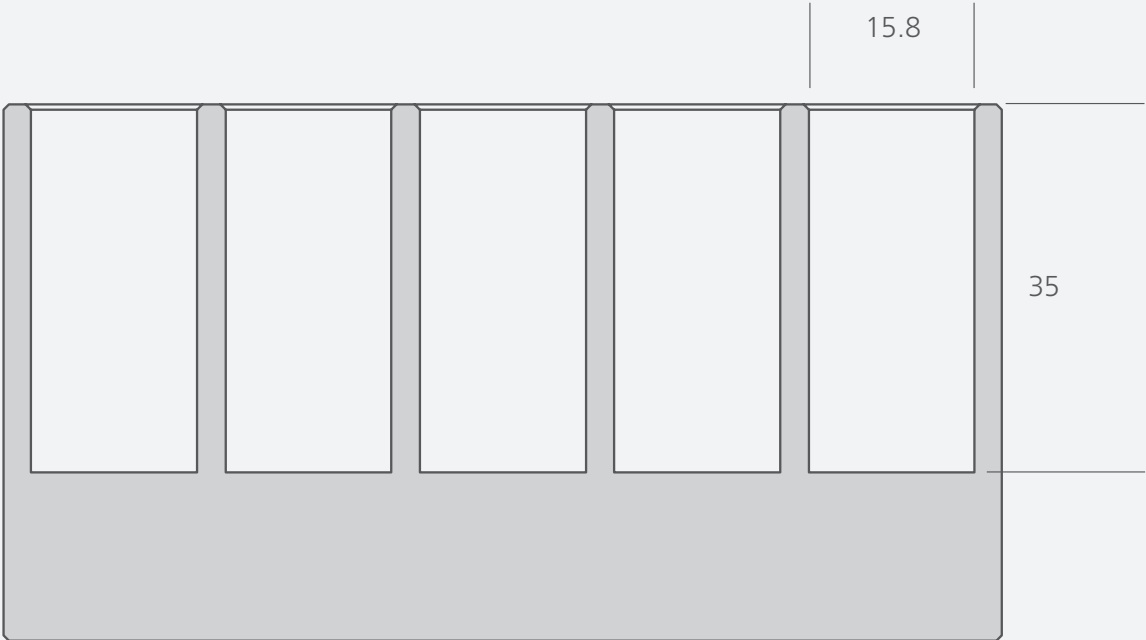

# Heating Block DB 5.3



mm





# Heating Block DB 5.4



mm



# Heating Block DB 5.5



mm

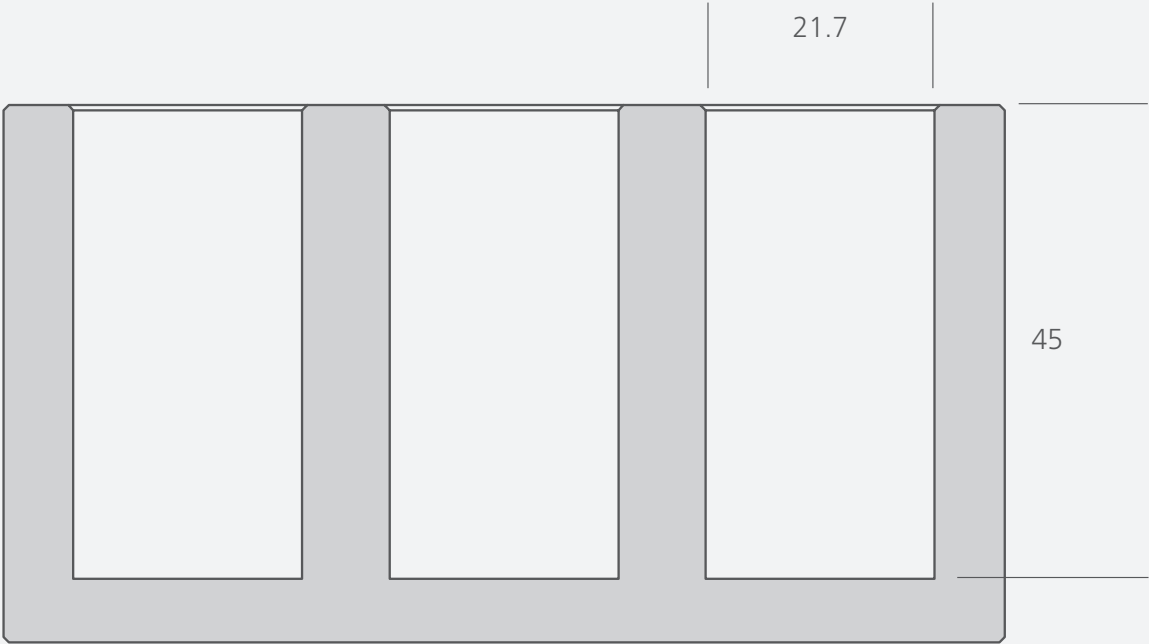

# Heating Block DB 5.6



mm



# Heating Block DB 5.7



mm

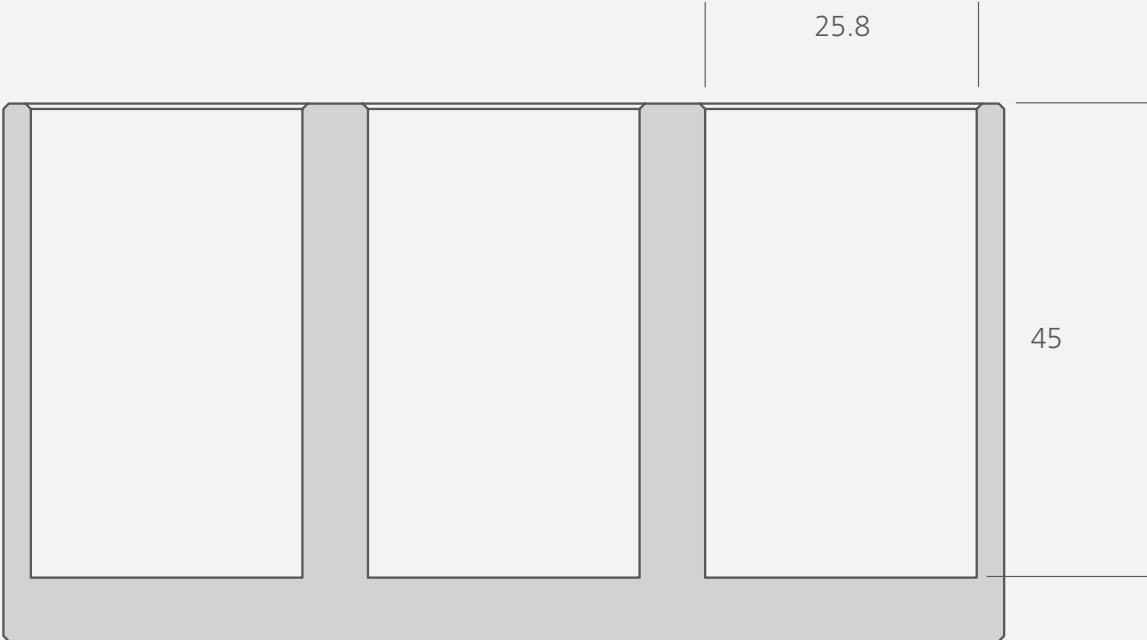

# Heating Block DB 5.8



mm



# Heating Block DB 5.9



mm



# Heating Block DB 6.1



mm



# Heating Block DB 6.2



mm

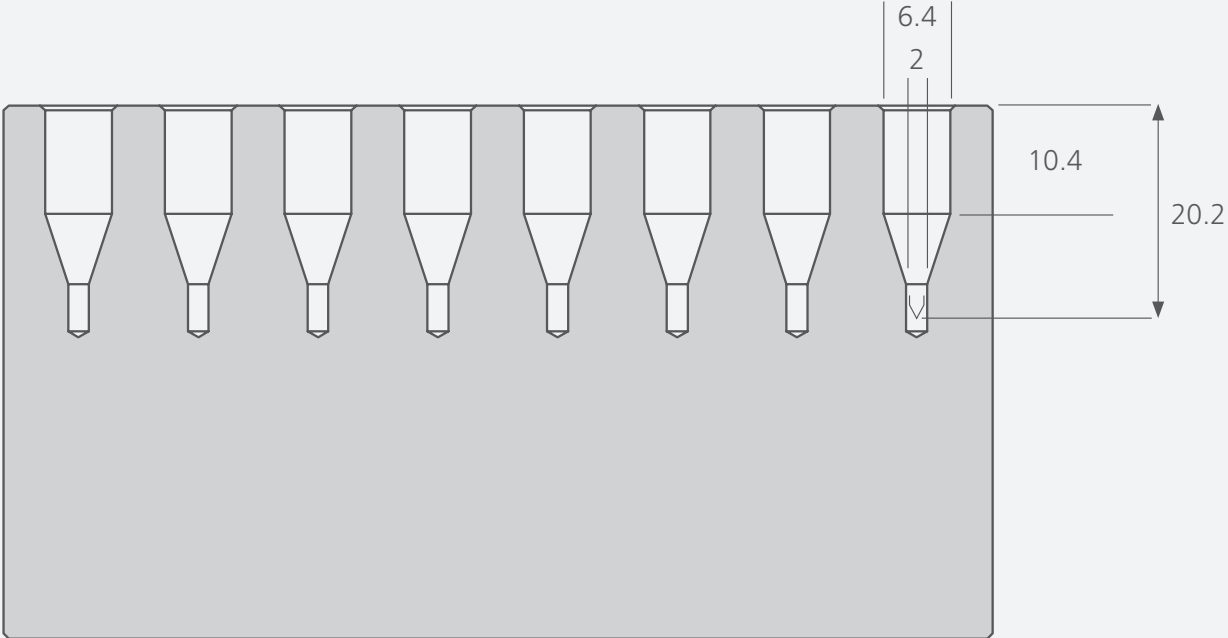



# Heating Block DB 6.3



# Heating Block DB 7.1



mm

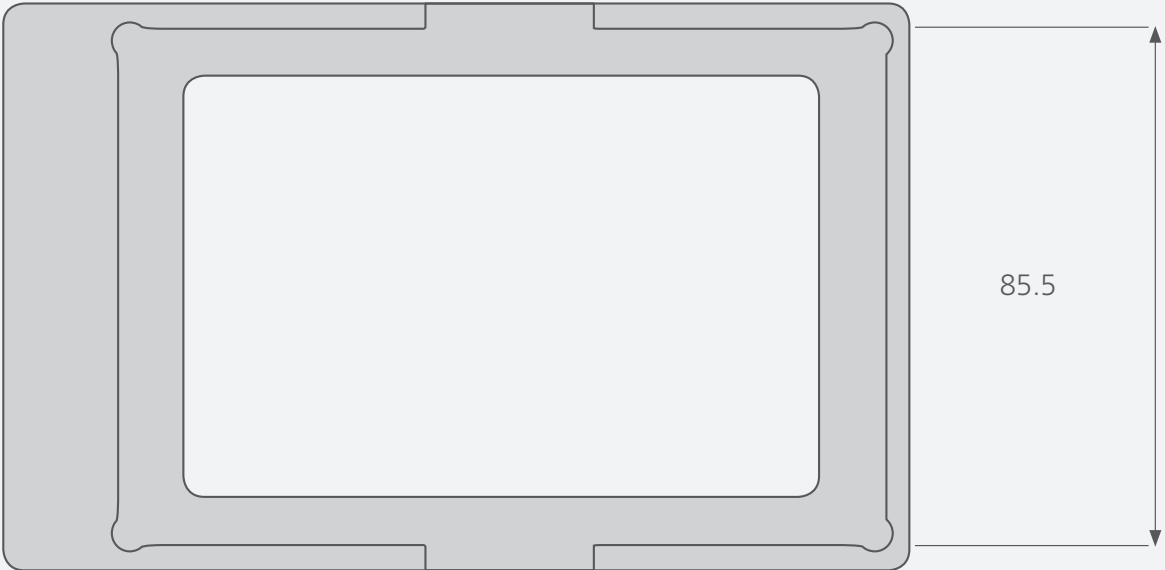
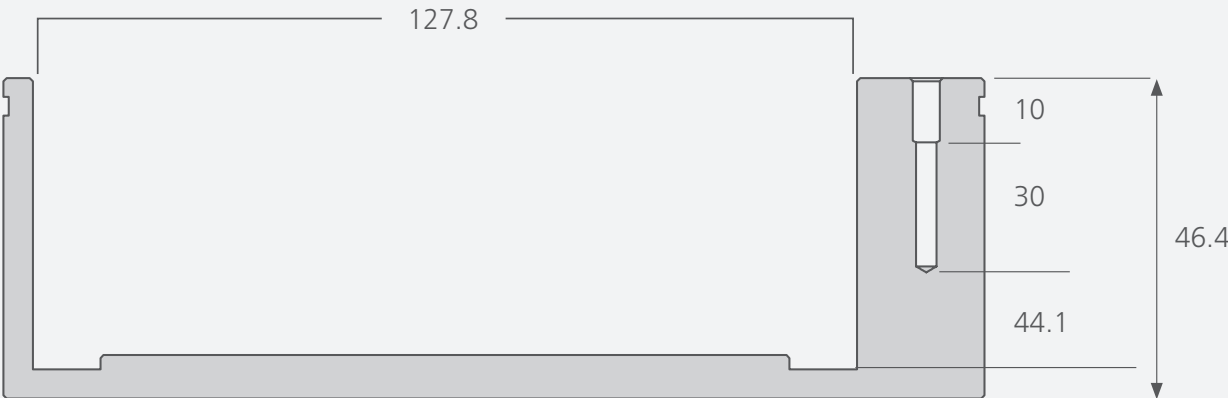

A-A (1:1) top view

# Heating Block DB 8.1



mm

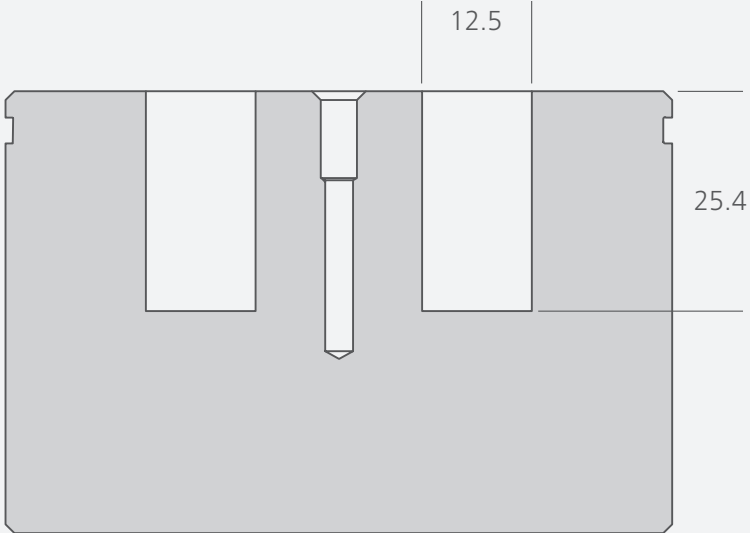

A-A (1:1)

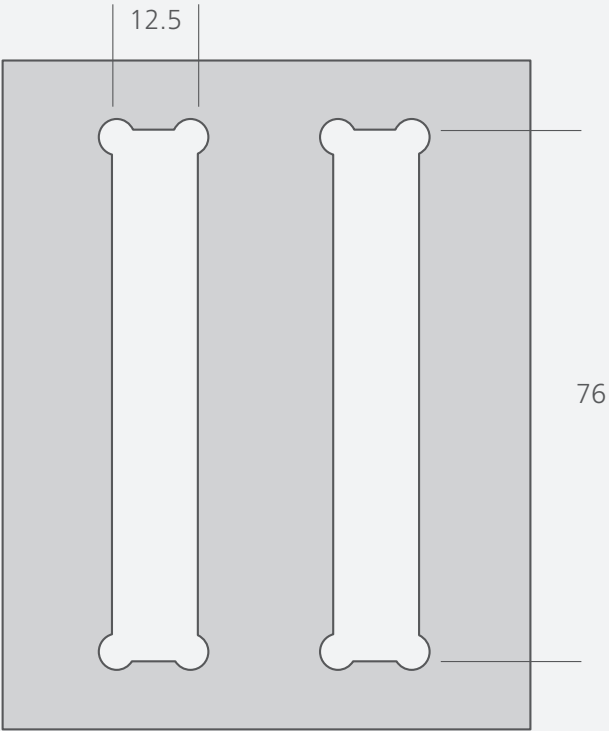

A-A (1:1) top view

## Dry Block Heater for a broad range of applications

---



### Dry Block Heater

Digital block heater for one to four aluminum blocks provides precise temperature control in small vessels. Included PT-1000 temperature sensor allows temperature control directly in the sample vessel. It is used with PCR tubes, PCR strips, Greiner tubes, microplates and cuvettes. The block heater is ideal for melting and boiling point determination, enzyme reactions, incubation and activation of cultures, immunoassays, DNA denaturation, culture media test, coagulation test, blood-urea-nitrogen determination and in situ hybridizations.



**Dry Block Heater 1**  
Ident. No. 0004025100

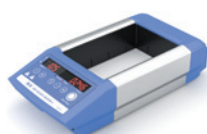

**Dry Block Heater 2**  
Ident. No. 0004025200

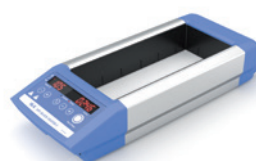

**Dry Block Heater 3**  
Ident. No. 0004025300

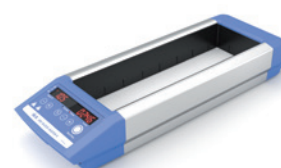

**Dry Block Heater 4**  
Ident. No. 0004025400