



Blood Bank Refrigerators

TSX Series

Installation and Operation

327930H01

Rev. G

December 2019

Visit us online to register your warranty
www.thermofisher.com/labwarranty

thermoscientific

IMPORTANT Read this instruction manual. Failure to follow the instructions in this manual can result in damage to the unit, injury to operating personnel, and poor equipment performance.

CAUTION All internal adjustments and maintenance must be performed by qualified service personnel.

Material in this manual is for informational purposes only. The contents and the product it describes are subject to change without notice. Thermo Fisher Scientific makes no representations or warranties with respect to this manual. In no event shall Thermo be held liable for any damages, direct or incidental, arising from or related to the use of this manual.

© 2019 Thermo Fisher Scientific Inc. All rights reserved.

For your future reference and when contacting the factory, please have the following information readily available. It can be found on the dataplate attached to your unit.

Model Number: _____

Serial Number: _____

The following information, if available, is helpful for contacting the factory.

Date Purchased: _____

Purchase order number: _____

Source of Purchase: _____

(manufacturer or specific agent/rep organization)

Table of Contents

Models	1
Safety Precautions	2
Unpacking	5
Packing List	6
General Recommendations	7
Temperature Monitoring.....	7
Intended Use	7
Operating Standards	8
Unit Specifications.....	9
Installation	10
Location	10
Wiring	14
Shelves	15
Drawers	15
Baskets	19
Temperature Sensor Bottles.....	20
Door Operation	20
Remote Alarm (Optional)	21
Final Checks	22
Startup	23
Initial Startup.....	23
Product Loading and Unloading Guidelines	23
Operation	25
Control Panel	25
Display Functions	27
Programming Functions	28
Service Parameters	28
Temperature Settings	31
Safety Trip.....	31
Alarms.....	31
Chart Recorder	33
Set Up and Operation	33
Changing Chart Paper	34
Power Supply	34
Calibration and Adjustments	35
Temperature Transmitter (Optional)	36
Powered Temperature Transmitter	36
Unpowered Temperature Transmitter.....	36
Maintenance	37

Table of Contents

Cleaning the Cabinet Interior	37
Cleaning the Condenser Filter.....	37
Cleaning the Condenser	37
Automatic Defrost	38
Gasket Maintenance	38
Alarm Battery Maintenance	38
Preparation for storage	38
Troubleshooting	39
End of Life Care.....	41
Warranty	42

1 Models

The table below shows the units covered in this operation and installation manual by model number. Refer to *Section 6.1* for details on the voltage specifications for the various models.

Table 1. Applicable Models

Unit	Model (*)	Energy Star Model (*) 
Thermo Scientific - TSX1204B*	V/Y/Z	A/D
Thermo Scientific - TSX2304B*	V/Y/Z	A/D
Thermo Scientific - TSX3004B*	V/Y/Z	A/D
Thermo Scientific - TSX5004B*	V/Y/Z	A/D

2 Safety Precautions

In this manual, the following symbols and conventions are used:



This symbol when used alone indicates important operating instructions which reduce the risk of injury or poor performance of the unit.



WARNING: This symbol indicates potentially hazardous situations which, if not avoided, could result in serious injury or death.



WARNING: This symbol indicates situations where dangerous voltages exist and potential for electrical shock is present.



WARNING: This symbol indicates potentially hazardous situations, which if not avoided could result in fire.



CAUTION: This symbol, in the context of a CAUTION, indicates a potentially hazardous situation which if not avoided could result in minor to moderate injury or damage to the equipment.

CAUTION: This indicates a situation which may result in property damage.



This symbol indicates surfaces which may become hot during use and may cause a burn if touched with unprotected body parts.



Before installing, using or maintaining this product, please be sure to read the manual and product warning labels carefully. Failure to follow these instructions may cause the product to malfunction, which could result in injury or damage.



This symbol indicates possible pinch points which may cause personal injury.



This symbol indicates the need to use gloves during indicated procedures. If performing decontamination procedures, use chemically resistant gloves.



This symbol indicates possible sharp points which may cause skin abrasion.

Below are important safety precautions that apply to this product:



Use this product only in the way described in the product literature and in this manual. Before using it, verify that this product is suitable for its intended use. If the equipment is used in a manner not specified by the manufacturer, the protection provided by the equipment may be impaired.



Do not modify system components, especially the controller. Use OEM exact replacement equipment or parts. Before use, confirm that the product has not been altered in any way.



WARNING: Your unit must be properly grounded in conformity with national and local electrical codes. Do not connect the unit to overloaded power sources.



WARNING: Disconnect the unit from all power sources before cleaning, troubleshooting, or performing other maintenance on the product or its controls.



WARNING: This unit is not for storage of flammable materials.



WARNING: This unit is charged with hydrocarbon refrigerants. Only qualified service personnel should service this unit.



WARNING: Unauthorized repair of your refrigerator will invalidate your warranty. Contact Technical Service at 1-800-438-4851 for additional information.



WARNING: No equipment that uses an open flame should be placed inside the refrigerator. This will harm the unit, hamper functionality and compromise your safety.



CAUTION: Do not use any battery powered or externally-powered equipment in the refrigerator.



CAUTION: Use appropriate Personal Protective Equipment (PPE) while handling the drawers to avoid possible sharp points related injury.

EMC

EMC Registration is done on this equipment for business use only. It may cause interference when the product would be used in home.

사용자 안내문 이 기기는 업무용 환경에서 사용할 목적으로 적합성평가를 받은 기기로서 가정용 환경에서 사용하는 경우 전파간섭의 우려가 있습니다.

This equipment has been tested and found to comply with the limits for a Class A digital device. Class A covers devices for usage in all establishments other than domestic and that are not directly connected to a low voltage power supply network, which supplies domestic environment.

This ISM device complies with Canadian ICES-001.

FCC

This equipment has been tested and found to comply with the limits for a Class A digital device, pursuant to part 15 of the FCC Rules. These limits are designed to provide reasonable protection against harmful interference when the equipment is operated in a commercial environment. This equipment generates, uses, and can radiate radio frequency energy and, if not installed and used in accordance with the instruction manual, may cause harmful interference to radio communications. Operation of this equipment in a residential area is likely to cause harmful interference in which case the user will be required to correct the interference at his own expense.

3 Unpacking

At the time of delivery, be sure to inspect the unit packaging for damage before signing for the shipment. If packaging damage is present, request immediate product inspection and file a claim with the carrier.

Note Packaging damage does not denote that unit damage exists.

If concealed damage is found (damage that is not apparent until the item has been unpacked), stop further unpacking and save all packing for carrier's inspection. Make a written request for inspection to delivering carrier. This must be done within 15 days after delivery. Then file a claim with the carrier.

Do not return goods to the manufacturer without written authorization.

4 Packing List

Inside the refrigerator cabinet is a bag containing:

- USB drive with this and other user manuals, including translated versions
- Certificate of Conformance
- Warranty Card
- Safety Data Sheet for Glycerin
- Quick start guide
- Two control panel keys
- Two cabinet door keys
- Chart recorder pamphlet
- Extra chart recorder paper

If the unit was ordered a unit with shelves, the bag will also include:

- Small bag with shelving clips

If specified on the order, the bag may also include:

- QC temperature graph and test log
- Calibration information

Other items with your unit include:

- Power cord
- Anti-Tip Bracket Kit (See *Section 7.1.2, Table 3* for applicable models)
- Baskets, Shelves or Drawers
- Thermal Bottles

5 General Recommendations

This section includes some general recommendations for your unit.

5.1 Temperature Monitoring



IMPORTANT NOTE We recommend the use of a redundant and independent temperature monitoring system so that the refrigerator can be monitored continuously for performance commensurate with the value of product stored. Please use the probe in glycerin bottle as the temperature reading reference point for all calibration / validation procedures.

5.2 Intended Use

The 4°C refrigerators described in this manual are intended for the storage of blood and blood products. All materials stored in these products must be in sealed blood bags. Product must not be stored in open containers. These products are intended for storing samples or inventory at operating temperatures between 2°C and 6°C.

Expected users of this equipment include but are not limited to personnel from the following areas: Professional and clinical (blood bank) laboratories, Pharma and Biotech facilities, Industrial and Government facilities or those trained in laboratory protocols put in place at your facility. The units are not for use by the general public.

These products should only be used by an authorized and adequately trained personnel.

It is considered a medical device and has therefore been registered with the medical device regulatory body FDA and is considered a Class 2 medical device by the FDA. This product is classified as product code *KSE, regulation number 864.9700 and is considered 510(K) exempt.*

This unit is not intended for use in classified hazardous locations, nor to be used for the storage of flammable or corrosive inventory.



CAUTION: Storage of sealed or unsealed corrosive substances may cause the interior of the unit to corrode. If stored for long periods of time, they could become unsealed due to moisture content of the refrigerator environment.

6 Operating Standards

The refrigerators described in this manual are classified for use as stationary equipment in a Pollution Degree 2 and Overvoltage Category II environment.

These units are designed to operate under the following environmental conditions:

- Indoor use
- Altitude up to 2000 m (6512 feet)
- Maximum relative humidity 60% for temperatures from 15 to 32°C (59 to 90°F).
 - For V models: Maximum relative humidity 75% for temperatures from 10°C to 35°C (50 to 95°F).
- Main supply voltage fluctuations not to exceed 10% of the nominal voltage.
- The refrigerator must not be connected to a GFCI (Ground Fault Circuit Interrupter) protected outlet as it may be subject to nuisance tripping.

Operation outside of these conditions will affect the performance of the unit and the samples stored inside.

6.1 Unit Specifications

The last character in the model number listed on the refrigerator identifies the electrical specifications for your unit.

The dataplate is located on the upper left side of the unit.

Table 2. Unit Specifications

Model	Rated Voltage	Rated Current	Frequency / Phase	Power Module Plug	Drawers/ 450ml Blood Bags	Approximate Weight Kg (lbs)	Exterior Dimensions (D x W x H)
12A / 12Y	115 V	6.25 A	60 Hz/1	IEC C19	6 / 192 (32 per drawer)	159 (350)	77.5 x 61.9 x 185.4 cm (30.5 x 24.0 x 73.0 in)
12D / 12Z	208-230 V	3.05 A	60 Hz/1				
12V	208-230 V	3.00 A	50 Hz/1				
23A / 23Y	115 V	4.5 A	60 Hz/1		7 / 385 (55 per drawer)	220 (485)	96.0 x 71.1 x 199.4 cm (37.8 x 28.0 x 78.5 in)
23D / 23Z	208-230 V	2.3 A	50/60 Hz/1			210 (464)	
23V	208-230 V	2.3 A	50/60 Hz/1			210 (464)	
30A / 30Y	115 V	9.25 A	60 Hz/1		6 / 426 (71 per drawer)	221 (486)	94.7 x 86.4 x 199.4 cm (37.3 x 34.0 x 78.5 in)
30D / 30Z	208-230 V	3.75 A	60 Hz/1				
30V	208-230 V	4.40 A	50 Hz/1				
50A / 50Y	115 V	10.2 A	60 Hz/1		14 / 770 (55 per drawer)	353 (779)	96.0 x 143.5 x 199.4 cm (37.8 x 56.5 x 78.5 in)
50D / 50Z	208-230 V	4.8 A	60 Hz/1				
50V	208-230 V	4.6 A	50 Hz/1				

7 Installation



WARNING: Do not exceed the electrical rating printed on the dataplate located on the upper left side of the unit.



CAUTION: Do not move the unit using the drain pan on the back. This could cause damage to the equipment.

7.1 Location

Install the unit on a level area free from vibration with a minimum of 6 inches of space on the sides and rear and 12 inches at the top. Do not position the equipment in direct sunlight or near heating diffusers, radiators, or other sources of heat.



WARNING: Do not move the unit while loaded. Unit shall always be moved when empty and by pushing slowly at handle level or lower on the unit. Be especially careful on any uneven surfaces.

7.1.1 Installation Instructions (Models A/D from Table 1)

The unit must be level both front to back and side to side when installed. If the unit is out of level, you may need to shim the corners or casters with thin sheets of metal. Be sure to set the brakes for units equipped with casters.



CAUTION: An unlevel unit may result in instability and performance issues for the doors and drawers.

7.1.2 Installation Instructions (Models V/Y/Z from Table 1)

The unit must be level both front to back and side to side when installed. If the unit is out of level, you may need to shim the corners or casters with thin sheets of metal. Be sure to set the brakes for units equipped with casters.



CAUTION: An unlevel unit may result in instability and performance issues for the doors and drawers.



WARNING: The refrigerator must be secured by the anti-tip bracket supplied. Unless properly installed, the refrigerator could tip when shelves/drawers/baskets are loaded. Injury and damage to the equipment and contents may result from the refrigerator tipping.

This refrigerator has been designed to meet all recognized industry tip standards for all normal conditions when anti-tip bracket is installed and properly engaged.

Table 3. TSX Blood Bank Refrigerator Model Numbers Requiring Anti-Tip Bracket Installation*

TSX1204BV	TSX2304BV	TSX3004BV	TSX5004BV
TSX1204BY	TSX2304BY	TSX3004BY	TSX5004BY
TSX1204BZ	TSX2304BZ	TSX3004BZ	TSX5004BZ

* Check the product data plate to confirm model number.

Anti-Tip Bracket Installation instructions are provided for wood and concrete floors. Any other type of construction may require special installation techniques as deemed necessary to provide adequate fastening of the anti-tip bracket to the floor. For installation on floors other than wood and concrete, please contact technical support.

The use of this bracket does not prevent the tipping of the refrigerator when not properly installed.

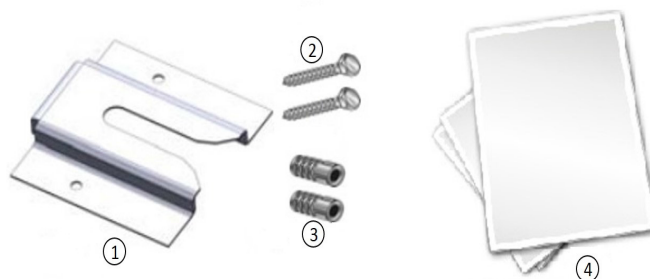

Figure 1. Materials Supplied

Label	Description
1	Bracket
2	Bolts
3	Anchors
4	Instructions and Installation Template

Table 4. Tools required

Wood Floor	Concrete Floor
Flashlight	
Tape Measure	
1/2" (13 mm) Wrench	
3/4" (19 mm) Wrench	
Drill	Hammer Drill
15/64" (6 mm) Drill Bit	1/2" (13 mm) Masonry Bit

1. Locating the Bracket

- a. Determine where you want the centerline of the refrigerator to be.
- b. Place the included template on the floor lined up with the centerline of the refrigerator and keep 6"-12" between the wall and the back of the unit.
- c. On the floor, mark the location of Hole #1 & Hole #2 (and Hole #3 & Hole #4 for double door units).

2. Anti-Tip Bracket Installation

Wood Construction

- a. Drill 15/64" (6 mm) pilot holes in locations marked in step 1.
- b. Place bracket on floor aligned with holes.
- c. Use supplied lag bolts to attach bracket to floor.

Concrete Construction

- a. Drill 1/2" (13 mm) holes in locations marked in step 1 with masonry bit.
- b. Slide lag screw anchors into holes to be flush with floor surface.
- c. Place bracket on floor aligned with holes.
- d. Use supplied lag bolts to attach bracket to floor.

3. Adjusting Bolt in Refrigerator

- a. Locate 1/2" bolt attached to bottom of cabinet.
- b. Unscrew 1/2" bolt until there is 1/2" clearance between floor and head of bolt as shown in *Figure 2* below.
- c. Tighten lock nut against bottom of unit.

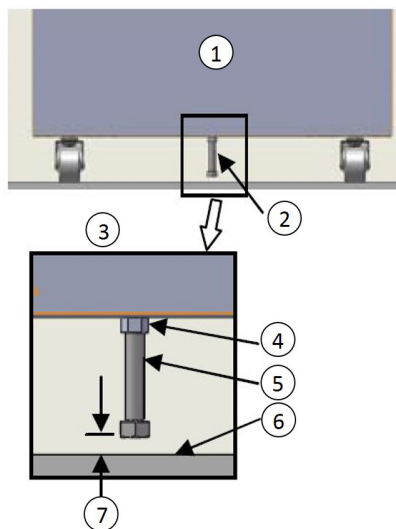

Figure 2. Bolt Location

Label	Description
1	Back of Unit
2	1/2" Bolt Location
3	Detailed View
4	Lock Nut
5	1/2" Bolt
6	Floor
7	1/2" Clearance

4. Refrigerator Positioning

- a. Line up 1/2" bolt installed in step 3 with anti-tip bracket.
- b. Roll or slide refrigerator into position until bolt stops against bracket.
- c. Lock the casters.

5. Checking the Installation

Check to see if the anti-tip bracket is installed properly by shining light under cabinet and confirming bolt in cabinet is secured by bracket on floor.

7.2 Wiring

The wiring diagrams are attached on the back of the cabinet.



CAUTION: Connect the equipment to the correct power source. Incorrect voltage can result in severe damage to the equipment.



CAUTION: For personal safety and trouble-free operation, this unit must be properly grounded while in use. Failure to ground the equipment may cause personal injury or damage to the equipment. Always conform to the National Electrical Code and local codes. Do not connect the unit to overloaded power lines.



CAUTION: Do not position the unit in a way that impedes access to the disconnecting device or circuit breaker in the back of the unit.



CAUTION: Always connect the unit to a dedicated (separate) circuit. Each unit is equipped with a service cord and plug designed to connect it to a power outlet which delivers the correct voltage. Supply voltage must be within $\pm 10\%$ of the unit rated voltage. If cord becomes damaged, replace with a properly rated power supply cord.

Table 5. Power Cord Specifications

Model	Power Cord Specifications
A / Y	3-G 12 AWG, NEMA 5-15P, 15 A/125 V
D / Z	3-G 14 AWG, NEMA 6-15P, 15 A/250 V
V	3-G 1.5 mm ² , CEE 7/7, 16 A/250 V



CAUTION: Never cut the grounding prong from the service cord plug. If the prong is removed, the warranty is invalidated.



CAUTION: In an emergency, the power cord is a disconnect device.

7.3 Shelves

Single door blood bank refrigerators have the option to be ordered with 4 wire shelves and double door blood bank refrigerators have the option to be ordered with 8 wire shelves.

Maximum shelf capacity is 45 kg (100 lbs).

For safety in shipping, the shelves are packaged and secured inside the cabinet. Insert the shelf support hangers (included with the manual inside the unit) into the built-in shelf supports (located on the inside walls of the cabinet interior) at the desired locations. Position the shelves on the flat supports (refer to *Figure 3*).

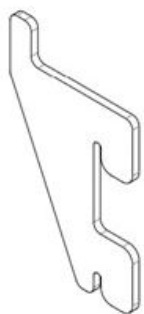

Figure 3. Shelf Support Hanger

7.4 Drawers

TSX1204 and TSX3004 blood bank refrigerators come standard with 6 drawers, TSX2304 blood bank refrigerators with 7 drawers, and TSX5004 blood bank refrigerators with 14 drawers.

Drawers are shipped in a factory installed position that promotes uniform spacing between the drawers. The drawer slides are adjustable to higher and lower positions in the cabinet. You can position these slides in the vertical slots which are spaced at one-inch intervals. The drawers must be removed in order to adjust the position of the drawer slides.

For TSX1204, TSX2304, and TSX5004, the maximum drawer capacity is 27 kg (60 lbs). For TSX3004, the maximum drawer capacity is 36 kg (80 lbs).



CAUTION: Use gloves when handling drawers to avoid injury due to potential sharp edges.



CAUTION: Be careful when handling the drawers as hidden sharp edges may be present.

7.4.1 Removing the Drawers

To remove the drawers, complete the following steps (refer to *Figure 4*):

1. Pull the drawer towards you until the slides are fully extended.
2. Lift the back of the drawer to disengage the mounting tabs from the slots on the slides.



Note The drawers fit snugly between the slides. Push the back to the drawer from underneath to remove the drawer.

3. Raise the back of the drawer almost to a vertical position and disengage the front mounting clips from the sides.

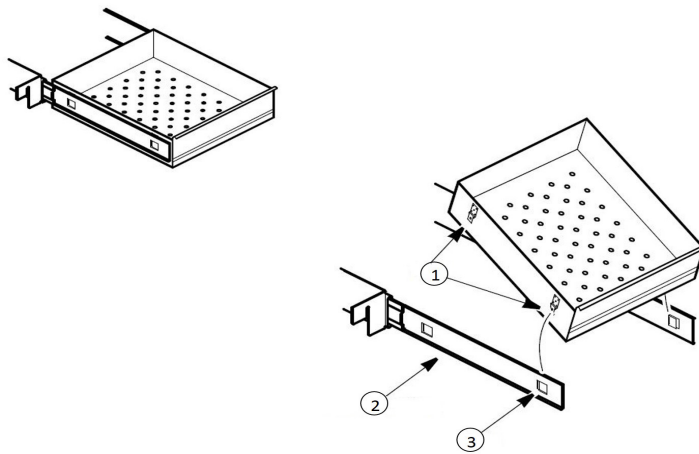

Figure 4. Drawer Removal

Label	Description
1	Tabs
2	Drawer slide
3	Slot

7.4.2 Reinstalling the Drawers

To reinstall the drawers, complete the following steps (refer to *Figure 4*):

1. Pull both the slides of the drawer towards you until the slides are fully extended.
2. Position the drawer between the slides and with the back facing end raised at 45 degree angle, insert the mounting clips at the front into the slots on front of the slides.
3. Push the back of the drawer down between the slides and insert the basket tabs into the slots at the back.



Note The drawers fit snugly between the slides. Push on the back of the drawer from the inside to insert the drawer tabs completely into the slots. Make sure both the drawer tabs are aligned with the slots on the slides before pushing the drawer down between the slides.



CAUTION: Be careful when reinstalling the drawers to avoid possible pinching.

7.4.3 Changing Drawer Position

Drawer slides have a small wire safety clip at the front pilaster which prevent the slides from falling when the drawer is removed. To change the position of the drawer slides, complete the following steps:

1. Locate the safety clip.
2. Slip a small screwdriver under the bottom of the wire clip and pry the clip towards the inside of the refrigerator.

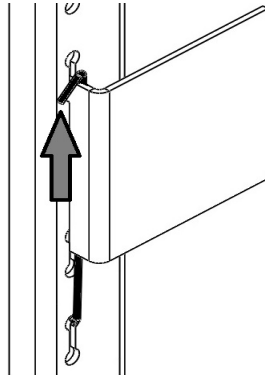

Figure 5. Clip Removal

3. Lift up the slide at the front. The slide is free to move from the front pilaster.

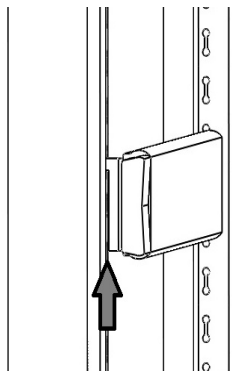

Figure 6. Front of slide Removal

4. The drawer slide must be removed from the rear pilaster at approximately a 45 degree angle towards the center of the cabinet.

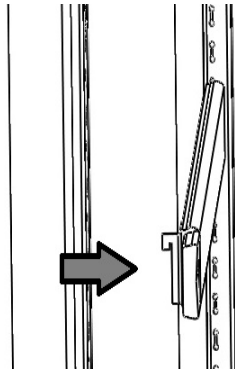

Figure 7. Slide Rotation

5. Pull the slide towards the front of the cabinet.
6. Determine desired location for the slide and insert the slide into the rear pilaster at a 45 degree angle towards the center of the cabinet.
7. Once the slide is seated in the rear pilaster, rotate the slide until it is parallel with the unit wall and insert slide into front pilaster.

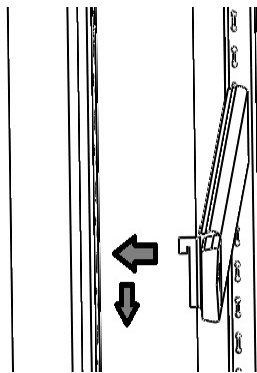

Figure 8. Slide Installation



CAUTION: Ensure the slide is level. If the slide is not seated in a level orientation, the drawers/baskets will not function as intended. This could cause injury or product damage.

8. Replace the safety clip by hooking the clip under the front pilaster slide bracket. Then rotate the wire safety clip to position the other bend of the wire safety clip to position the other bend of the clip over the top of the same bracket.

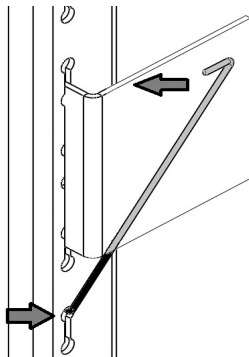

Figure 9. Clip Replacement



CAUTION: Drawer slides do *not* require lubrication. Additional lubricant could impede movement of the drawers when lubricant is cold.

7.5 Baskets

Baskets can be ordered as an accessory for this unit.

The basket slides are adjustable to higher and lower positions in the cabinet. You can position these slides in the vertical slots which are spaced at one-inch intervals. The baskets must be removed in order to adjust the position of the slides. The procedure for removing, reinstalling, and changing position of the baskets can be found in *Section 7.4.1*, *Section 7.4.2*, and *Section 7.4.3*.

The maximum basket capacity is 27 kg (60 lbs).

7.6 Temperature Sensor Bottles

The temperature displayed on the control panel and chart recorder are measured by probes inserted in the sensor bottles inside the cabinet. The sensor probes must be inserted in the glycerin bottle prior to operation.

There are two sensor bottles at different heights. The upper bottle is positioned on the left wall and the lower bottle is positioned on the back wall.

To install the sensor(s) into the bottles, complete the following steps:

1. Remove the bottle from the bracket and verify that each bottle is full of liquid.

Note To better access the bottom bottle, the bottom two drawers may need to be removed following the instructions in *Section 7.4.1*.

2. Remove the solid cap from the bottle and save for the next time the unit needs to be moved.
3. Remove the taped lid and temperature sensor(s) from the wall.
4. Insert the temperature probe(s) into the bottle.
5. Secure the cap to the bottle and return the bottle to the bracket.

7.7 Door Operation

The doors on all units are designed to stay open if opened 90 degrees or more. The door spring tension cannot be adjusted.

If the self-closing door does not work properly, make sure the unit is level.



CAUTION: Door seal integrity is critical for refrigerator performance. Never route anything through the door seal. A loose fitting gasket allows moist air to be drawn into the cabinet, resulting in quicker frost buildup on the evaporator coil, longer running time, poor temperature maintenance, and increased operation cost.



CAUTION: Keep hands and body parts clear of closing doors. The moving parts create a potential pinch point.

There are port holes in the walls of the cabinet to help facilitate routing of independent temperature sensors. Be sure to seal the holes after routing the wires to prevent undesired air exchange.

7.8 Remote Alarm (Optional)

All units have factory-installed local alarm contacts that can be used for remote alarm systems. The maximum distance between a refrigerator and a remote alarm depends on the wire gauge used. Refer to *Table 6* below:

Table 6. Wire Gauges and Distance to Remote Alarm

Wire Gauge	Total Wire Length (feet)	Distance to Alarm 1/2 Wire Length (feet)
20	530	265
18	840	420
16	1330	665
14	2120	1060
12	3370	1685

Remote alarm terminals are located at the rear of the machine compartment. The three terminals are: COMMON, OPEN ON FAIL (Normally Closed), and CLOSE ON FAIL (Normally Open).

REMOTE ALARM CONNECTIONS

CONNEXIONS DE L'ALARME À DISTANCE

CONTACT RATING 1 AMP MAX
CLASS 2 CIRCUIT ONLY

VALEUR NOMINALE DE CONTACT DE 1 AMP MAX.
SUR UN CIRCUIT DE CLASSE 2 UNIQUEMENT

WIRE COLOR (FIL DE COULEUR)	FUNCTION (FONCTION)
 PURPLE (VIOLET)	COMMON (COMMUNE)
 BLACK (NOIR)	OPEN ON FAIL (EN POSITION OUVERTE)
 RED/WHITE (ROUGE/BLANC)	CLOSE ON FAIL (EN POSITION FERMÉE)

Figure 10. Remote Alarm Diagram

To install the remote alarm, make the following connections:

1. Connect the COMMON terminal on the cabinet switch to the COMMON wire on the alarm.
- 2a. To get an alarm when the switch contacts open, connect the OPEN ON FAIL terminal on the cabinet to the OPEN ON FAIL wire on the alarm.

- 2b. To get an alarm when the switch contacts close, connect the CLOSE ON FAIL terminal on the cabinet to the CLOSE ON FAIL wire on the alarm. The COMMON and CLOSE ON FAIL wires must be tied together in this application.
3. Plug the alarm system service cord into an electrical outlet.

The contacts will trip in the event of a power outage, high temperature alarm or low temperature alarm.

7.9 Final Checks

Before start up, be sure to complete the following steps:

1. Make sure that the unit is free of all wood or cardboard shipping materials, both inside and outside.
2. Check the positions of the shelves, drawers and baskets. If you want to adjust the positions, see instructions in *Section 7.3*, *Section 7.4* and *Section 7.5*.
3. Verify that the unit is connected to a dedicated circuit.

8 Startup

8.1 Initial Startup

To start up the refrigerator, complete the following steps:

1. Verify that the sensor probe(s) have been installed in the bottle(s) as described in *Section 7.6*.
2. Ensure the double pole circuit breaker switch located next to the power inlet is in “ON” position (i.e. “I” position).
3. Insert the key in the switch and turn to the **Power On** position. The display will show the actual cabinet temperature and the compressor and evaporator should start within approximately 10 minutes.
4. Allow the unit to reach operating temperature before loading it with any product. To stabilize the temperature profile, a 24-hour waiting period is recommended.
5. If you desire to enable the alarms, turn the three position key switch one turn further clockwise to the **Alarm On** position. To avoid nuisance alarms, wait until the unit has pulled down to the desired operating temperature (4°C default).
6. If you have a remote alarm, hook it up at this point (refer to *Section 7.8*).
7. If desired, lock the cabinet door using the key. Place duplicate key copies in a safe place.

All controls should now be fully operational, the alarm active (if enabled), and all visual indicators active.

8.2 Product Loading and Unloading Guidelines

When loading your blood bank refrigerator, take care to observe the following guidelines:

- Never load the blood bank beyond capacity. The number of 450 ml bags that are recommended for your unit can be found in *Table 2*.
- Distribute the load as evenly as possible. Temperature uniformity depends on air circulation, which could be impeded if the drawers are overfilled, particularly at the top of the cabinet.
- For critical applications such as blood storage, be sure that the alarm systems are working and active before you load any product.
- Ensure clearance between the top of the cargo and the bottom of the shelf/drawer/basket. Lack of clearance may affect unit performance or impede operation of drawer/basket. Keep cargo within the bounds of the shelf/drawer/basket.

- For initial product loading and after removing the drawers for cleaning, be sure to load the unit from the bottom drawer up to ensure the drawers are seated properly.
- Only open one drawer or basket at a time.
- The floor of the cabinet should not be loaded.
- Never load the unit above the load limit line. This is important to ensure that air can circulate properly and evenly distribute the temperature throughout the interior.



Figure 11. Load Limit Line

9 Operation

9.1 Control Panel

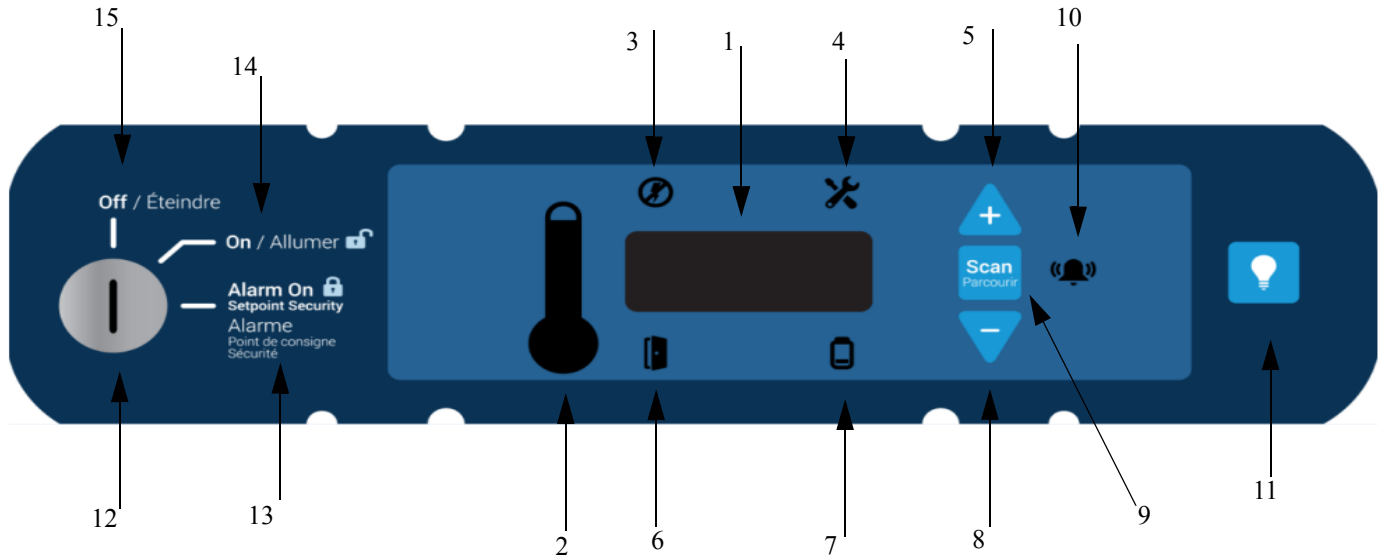

Figure 12. Refrigerator Control Panel

The control panel is located on the top right side of your blood bank refrigerator. You can use the three pushbuttons (#5, #8, and #9 in *Figure 12*) to change the temperature display (#1) or to adjust temperature and alarm setpoints as given in *Section 9.3*. The thermometer display (#2) provides a quick visual indicator of current cabinet temperature and alarm conditions.

1. **Main temperature display** - during normal operation, shows cabinet temperature in degrees Celsius, as measured by the primary sensor inside the cabinet. You can use the buttons to display other values such as setpoints, highest and lowest recorded temperatures and lower sensor temperature. The number in the main display flashes when the value can be modified.
2. **Thermometer** - shows cabinet temperature and alarm conditions. There are 10 horizontal bars: 9 are displayed during normal operation, the tenth (top) bar indicates a warm alarm condition. The number of bars illuminated indicates approximate cabinet temperature. With the default settings, 5 to 7 bars illuminated indicate that the cabinet is at desired setpoint. For example, suppose that the cabinet temperature setpoint is 4°C and that the warm and cold alarm setpoints are 5.5°C and 2°C. Then the number of bars illuminated indicates cabinet temperature as follows:

Table 7. Thermometer Display on Control Panel (Setpoint 4°C)

Bars Displayed	Temperature (°C)	Bars Displayed	Temperature (°C)
Bulb Only	2 (cold alarm)	6 Bars	4.1
1 Bar	2.35	7 Bars	4.45
2 Bars	2.7	8 Bars	4.8
3 Bars	3.05	9 Bars	5.15
4 Bars	3.4	10 Bars	5.5 (warm alarm)
5 Bars	3.75		

When cabinet temperature exceeds the warm alarm setpoint, the top bar of the thermometer flashes. When temperature is lower than the cold alarm setpoint, the bulb flashes. When you are in programming mode (described in *Table 9*) the thermometer shows the setpoint value you are changing.









3. **Power failure** - illuminates when the main power supply is interrupted. In this case the audible alarm also sounds.
4. **Service mode** - illuminates when the controller is in service programming mode.
5. **Increase** - pushbutton used to increase setpoint values in programming mode and for various display functions.
6. **Door ajar** - illuminates when the refrigerator door is open longer than the duration specified in the service parameters table, default is approximately 3 minutes (when the alarm is activated and the key switch is turned to the alarm position).
7. **Battery low** - illuminates when the backup battery is low (refer to *Section 12.6*).
8. **Decrease** - pushbutton used to decrease setpoint values in programming mode and for various display functions.
9. **Scan** - pushbutton used to change the main display and for various other functions.
10. **Audible alarm** - illuminates during warm and cold alarm conditions.
11. **Light Switch** (glass doors only) - pushbutton switch to toggle the refrigerator light on and off without opening the door. Light will always come on when the door is opened.

- 12. **Key Switch** - switch used to turn the power and alarms on and off for the unit.
- 13. **Alarm On** - Setpoint Security - when the key switch is in the alarm on position, the alarms are on and the setpoints cannot be modified.
- 14. **Power On** - when the key switch is in the on position, the unit power is on with no alarms active.
- 15. **Off** - when the key switch is in the off position, the unit is off.



For full descriptions of display, programming and service functions, refer to *Tables 8, 9, and 10.*

9.2 Display Functions

Table 8. Control Panel Display Functions



Function	Meaning	Sequence	Display
Normal operation	Default display while refrigerator is running.		Temperature display and control panel thermometer icon show cabinet temperature.
Coldest logged temperature	Show coldest cabinet temperature since last startup or reset.	Press 	Display shows coldest logged temperature while button is pressed.
Warmest logged temperature	Show warmest cabinet temperature since last startup or reset.	Press 	Display shows warmest logged temperature while button is pressed.
Mute	Silence audible alarm for approximately 6 minutes.	Press 	Display and thermometer show cabinet temperature, alarm icon continues to flash.
Reset	Return to default display after alarm condition, clears temperature log.	Press and hold  and  simultaneously.	Excursion values are reset; temperature display shows cabinet temperature.
Second Sensor	Displays second sensor temperature	Press  and  simultaneously and hold for approximately 5 seconds.	Display shows second probe temperature while buttons are held, returns to primary temperature display when buttons are released. ERR is displayed if no lower sensor probe is detected.
Alarm Test	Test by simulating warm alarm followed by cold alarm. Key switch must be in alarm mode	Press  and  simultaneously, hold for approximately 5 seconds.	First, the display will show "AtSt" to show entry of the test. Display and thermometer show simulated cabinet temperatures (warm then cold), alarms flash and sound as appropriate. Alarms clear when test is completed.

9.3 Programming Functions

You can enter the programming mode by pressing the Scan button  and holding for approximately 5 seconds. The display will then flash “Prg” to indicate that you have entered the programming mode. Use (▲) and (▼) buttons to modify the values and press the scan () button to save the value and go to the next screen.

Note If the alarms are enabled, all parameters are read only and cannot be edited.



Table 9. Setpoint Programming Functions

Screen/Button		Function	Summary
1	Initial Screen	Unit Set point	The temperature that the unit is set to run
2	Press Scan ()	Cold Alarm Temperature	The temperature that will actuate the cold alarm (if active)
3	Press Scan ()	Warm Alarm Temperature	The temperature that will actuate the warm alarm (if active)
4	Press Scan ()	Exit Program Mode	Returns to normal operating screen

If the unit is left idle for a period of approximately 30 seconds during program mode, the program mode shall be exited.

If at any point the scan button is pressed and held for a period of approximately 10 seconds, the unit shall enter the service mode.

9.4 Service Parameters

You can enter the service mode by pressing the Scan button () and holding for approximately 10 seconds while in Programming mode (refer to *Section 9.3*). The display will then flash “SEr” to indicate that you have entered the service mode followed by the software checksum values flashing on the screen. The service icon () will also illuminate. Use up (▲) and down (▼) buttons to modify the values and press the scan () button to save the value and go to the next screen.

Note If the alarms are enabled, the unit will not enter Service Mode.



CAUTION: Resetting any of the following parameter values could adversely affect the performance of your blood bank refrigerator. These settings very rarely need to be changed from normal 4°C operation. Be sure to understand your product requirements prior to making any adjustments to the service parameter values. Call technical support if you have any questions prior to making any adjustments to service parameter values.

Table 10. Service Parameters



















Screen/Button		Display	Function	Summary
1	Initial Screen	SEr 04	Temp of unit	Allows the user to see what temperature the unit is designed to run.
		Varies	CPU Checksum	Shows the current checksum of the CPU board for validation.
		Varies	Relay Board Checksum	Shows the current checksum of the Relay board for validation.
		tyP	Model Type	Displays unit type 04 for +4 refrigerator. This parameter should never be changed.
2	Press Scan ()	CFg	Type of unit	Type of unit (01). This parameter should never be changed.
3	Press Scan ()	CuFt	Size of the unit	Setting for Size of the unit.
4	Press Scan ()	Pd oFSt	Control Probe Pulldown Offset	The difference in temperature between the control probe value and the average compartment temperature that determines when the control system changes from pull down mode to steady state operation. This can be useful to adjust if the average compartment temperature has an undershoot or overshoot relative to set point during pull down mode. This offset is also used on some refrigerator models as a response to door openings.
5	Press Scan ()	Cnt oFSt	Control Probe Offset	The difference in temperature between the control probe value and the average compartment temperature that is used to control the cooling system to the unit set point during steady state operation. This can be useful to adjust if there is a discrepancy between the unit set point and the average cabinet temperature.
6	Press Scan ()	dIS oFSt	Display Probe Offset	The difference in temperature between the display probe value seen on the User Interface display and the average compartment temperature at the unit set point during steady state operation. This can be useful to adjust the display during unit calibration procedures.
7	Press Scan ()	Cnt ucl	Control Upper Hysteresis	The degree increase in temperature from the set point that will trigger the unit to begin cooling to prevent the unit from getting too warm.
8	Press Scan ()	Cnt lcl	Control Lower Hysteresis	The degree decrease in temperature from the set point that will trigger the unit to stop cooling to prevent the unit from getting too cold.
9	Press Scan ()	door AJAr	Door Alarm Time	The approximate time the door can remain open before the door ajar alarm activates in minutes.
10	Press Scan ()	dEF Int	Defrost Interval	The time interval between defrost cycles in hours.
11	Press Scan ()	dEF dur	Defrost Duration	The maximum amount of time the defrost cycle will run in minutes.



Table 10. Service Parameters

Screen/Button		Display	Function	Summary
12	Press Scan 	dEF Hi	Defrost Temp Out	The maximum temperature that the defrost probe can reach before stopping the defrost cycle.
13	Press Scan 	qUA	Quality Mode	Normally OFF(00) Used for production line testing.
14	Press Scan 	bot	BOT Mode	Normally OFF(00). If ON(01), the unit is forced to run at coldest possible temperature for approximately 24 hours. Defrosts will still occur as scheduled.
15	Press Scan 	PEr	Perimeter Heater Duty Cycle	Controls the perimeter heater ON time (only applicable on swinging door models).
16	Press Scan 	Cnt Prb	Control Probe Temperature	Displays control probe temperature (Read only).
17	Press Scan 	Anb Prb	Ambient Probe Temperature	Displays ambient probe temperature in deck (Read only).
18	Press Scan 	d lo Prb	Lower Display Probe	Displays the lower bottle probe temperature (Read only).
19	Press Scan 	dEF Prb	Defrost Probe Temperature	Displays defrost probe temperature (Read only).
20	Press Scan 	---	Enter Defrost Cycle	Pressing the Scan button after displaying the defrost probe temperature while not in an alarm mode will force the unit into a defrost cycle. To avoid defrost cycle, leave unit screen idle for approximately 30 seconds.

If the unit is left idle for a period of approximately 30 seconds during service mode, the unit will exit service mode and return to normal operation.

Note If an alarm occurs while in the service mode, it will not show until exiting this mode.

To reset values back to factory settings, perform the following procedure:

1. Turn keyswitch to “OFF” position.
2. Hold the up () and down () arrows while turning the keyswitch to the “ON” position.
3. Continue to hold buttons for approximately 10 seconds.
4. Release buttons and turn keyswitch to “OFF” position.
5. Turn keyswitch to “ON” position.



CAUTION: Performing this reset will overwrite any changes that were made after the receipt of this unit.

9.5 Temperature Settings

The unit has been set to maintain a temperature of 4°C. For most applications, you will not need to change the temperature setpoint. However, the setpoint can be changed if desired. To change the factory temperature settings, refer to the instructions in *Section 9.3*.



CAUTION: The refrigerator described in this manual is designed for optimum performance at 4°C. It is advisable to call Technical Service before changing setpoints.

9.6 Safety Trip

The Blood Bank refrigerators are equipped with a safety trip which prevents product from freezing in the event of loss of temperature control.

The safety trip is designed to turn off the cooling system when the temperature reaches 2°C, according to the sensor located in the bottom of the unit. The safety trip automatically allows the cooling system to be reactivated based on product temperature.

9.7 Alarms

The alarm system is designed to provide visual and audible warning signals for both power failure and rise in temperature. The alarm is equipped with a battery backup.

Default cold and warm alarm values are 2°C and 5.5°C. These values may be adjusted, following instructions in *Section 9.3*.



The alarm system is activated only when the key switch is turned to the Alarm On position. The audible warning signal sounds when there is a power failure, temperature alarm condition, or when the door is ajar for approximately more than 3 minutes.

The Mute function (pressing the  button) allows you to turn off the audio warning without turning off the visual indicators. The alarm will ring back after approximately 6 minutes if the alarm is still active.

During a warm alarm, a flashing of the uppermost bar of the thermometer, the temperature display, and the speaker icon will occur at the same time. If there has been a warm alarm since the last alarm reset, but the temperature is not currently in an alarm state, the uppermost bar of the thermometer and the speaker icon will slowly alternate in flashing.

During a cold alarm, a flashing of the bulb of the thermometer, the temperature display, and the speaker icon will occur at the same time. If there has been a cold alarm since the last alarm reset, but the temperature is not currently in an alarm state, the bulb of the thermometer and the speaker icon will slowly alternate in flashing.

During a power failure, the power failure icon will illuminate, the thermometer will display without the bulb, and the temperature will flash approximately every 3 seconds. If there has been a power failure since the last alarm reset, the power failure icon and the speaker icon will slowly alternate in flashing.

During a low battery condition, the low battery icon will illuminate. The alarms can be reset by pressing and holding the  and  simultaneously.

10 Chart Recorder

Panel-mounted six inch recorders are standard and factory-installed on all models.

Recorder operation begins when the system is powered on.

10.1 Set Up and Operation

To prepare the recorder to function properly, complete the following steps:

1. Open the recorder door to access the recorder.
2. Connect the nine volt DC battery located at the recorder's upper right corner. This battery provides back-up power.
3. Install clean chart paper (refer to *Section 10.2* at the next page).
4. Close the recorder door.



Note The recorder may not respond until the system reaches temperatures within the recorder's range.

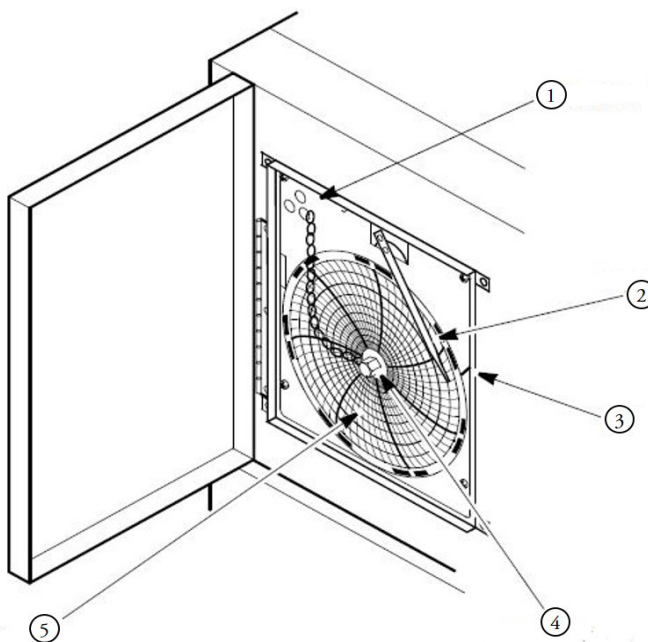

Figure 13. Chart Recorder

Label	Description
1	Pressure Sensitive Chart Buttons
2	Imprinting Stylus
3	Reference Mark
4	Hub-Nut and Retaining Wire
5	Chart

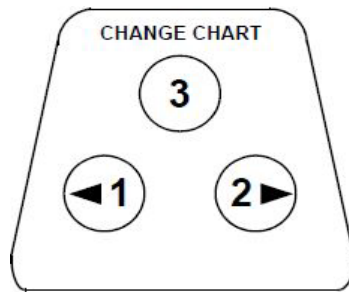

Figure 14. Chart Buttons

10.2 Changing Chart Paper

To change the chart paper, complete the following steps:

1. Locate the pressure sensitive buttons at the front, upper left of the recorder panel.
2. Press and hold the change chart button (#3 in *Figure 14*) for approximately one second. The pen will move off the scale.
3. Unscrew the center nut, remove the old chart paper, and install new chart paper. Carefully align the day and time with the reference mark on the recorder panel (a small groove on the left side of the panel, as shown in *Figure 13*).
4. Replace the center nut and hand tighten. Press the change chart button again (#3) to resume temperature recording.



Note Be careful not to pull up on the chart recorder arm while changing paper. Pulling on the arm may damage the recorder.



CAUTION: Do not use sharp or pointed objects to depress the chart buttons. This may cause permanent damage to the recorder.

10.3 Power Supply

The recorder normally uses AC power when the system is operating. If AC power fails, the LED indicator on the recorder flashes to alert you to a power failure. The recorder continues sensing cabinet temperature and the chart continues turning for approximately 24 hours with back-up power provided by the nine-volt battery.

The LED indicator glows continuously when main power is functioning and the battery is charged.

When the battery is low, the LED flashes to indicate that the battery needs to be changed.

10.4 Calibration and Adjustments

This recorder has been accurately calibrated at the factory and retains calibration even during power interruptions. If required, however, adjustments can be made as follows:

1. Run the unit continuously at the control setpoint temperature. Continue steady operation for at least two hours to provide adequate time for recorder response.
2. Measure cabinet center temperature with a calibrated temperature monitor.
3. Compare the recorder temperature to the solution temperature. If necessary, adjust the recorder by pressing the left and right chart buttons (#1 and #2 from *Figure 14*) for approximately 5 seconds.



Note The stylus does not begin to move until the button is held for approximately 5 seconds.

11 Temperature Transmitter (Optional)

11.1 Powered Temperature Transmitter

A powered temperature transmitter is an option for this unit. This temperature transmitter allows for remote temperature monitoring of your system.

To connect your remote temperature monitoring system to the powered temperature transmitter, refer to *Figure 15*.

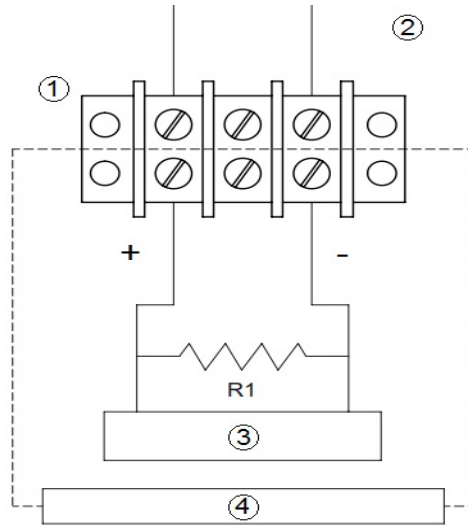

Figure 15. Powered Temperature transmitter

Label	Description
1	Terminal Strip
2	Rear of Unit
3	Controller and/or Indicator
4	Customer Provided System

Note The building management system load wiring must have a resistance less than 340 ohms.

11.2 Unpowered Temperature Transmitter

An unpowered temperature transmitter is an option for this unit. This temperature transmitter allows for remote temperature monitoring of your system.

To connect your remote temperature monitoring system to the unpowered temperature transmitter, refer to the diagram attached on the back of the unit.

12 Maintenance



WARNING: Disconnect equipment from main power before attempting any maintenance to equipment or its controls unless stated otherwise.

12.1 Cleaning the Cabinet Interior

To clean the cabinet interior, remove the shelves, drawers, or baskets following the instructions in *Section 7.3*, *Section 7.4* and *Section 7.5*. Use a solution of water and a mild detergent for cleaning. Rinse the interior storage components and wipe them dry with a soft cloth.

12.2 Cleaning the Condenser Filter

Clean the condenser filters every three months. There is one condenser filter located in the back cage of the unit that can be accessed without removing the back cage or disconnecting the power.

To clean the filter, complete the following steps:

1. Remove the filter by pulling upwards through the slot in the back cage.
2. Shake the filter to remove loose dust.
3. Rinse the filter in clean water.
4. Shake the excess water from the filter and let it dry.
5. Reinstall filter by pushing downwards through the slot in the back cage.



CAUTION: Do not pull the filter downwards from the bottom. The condenser has sharp surfaces.

12.3 Cleaning the Condenser



CAUTION: Condensers should be cleaned at least every six months; more often if the laboratory area is dusty. In heavy traffic areas, condensers load with dirt more quickly. Failure to keep the condenser clean can result in equipment warm-up or erratic temperatures.



CAUTION: Never clean around the condensers with your fingers. Some surfaces are sharp.

The condenser is located in the top rear of the machine compartment. To clean the condenser, complete the following steps:

1. Disconnect the power.
2. Remove the filter.

3. Vacuum the condenser and clean up any loose dust.
4. Replace the filter.
5. Reconnect power.

12.4 Automatic Defrost

The defrosting process on all models is primarily accomplished by air circulated during off-cycle periods. This heat-free process ensures that the temperature is not affected by the defrost cycle. The default defrost cycle runs approximately once per hour and terminates once a preset evaporator temperature or timer criteria is reached.

Defrost water is collected in a pan in the rear of the unit and evaporated using system heat. No maintenance is required.

12.5 Gasket Maintenance

Periodically check the gaskets around the door for punctures or tears. Leaks are indicated by condensation or frost which form at the point of gasket failure. Make sure that the cabinet is level (refer to *Section 7.1.1* for leveling information).

Keep the door gaskets clean and frost free by wiping gently with a soft cloth.

To check the door seal, complete the following steps:

1. Open the door.
2. Insert a strip of paper (a couple of inches wide) between the door gasket and the cabinet flange and close the door.
3. Slowly pull the paper strip from the outside. You should feel some resistance.
4. Repeat this test at 4-inch intervals around the door. If the door does not seal properly, replace the gasket.

12.6 Alarm Battery Maintenance

Have a certified technician replace the alarm battery every twelve months at most or when the alarm is active. The part number for a replacement battery is 322533H01.

12.7 Preparation for storage

If the unit is going to be stored in an off condition, allow the unit to warm up and dry out with the door open before moving into storage.

13 Troubleshooting



WARNING: Troubleshooting procedures involve working with high voltages which can cause injury or death. Troubleshooting should only be performed by trained personnel.

This section is a guide for troubleshooting equipment problems.

Table 11. Troubleshooting Procedures

Problem	Cause	Solution
Unit does not operate or Power Failure Indicator is on	Power supply	<p>Check that the cord is securely plugged in.</p> <p>Plug another appliance into the outlet to see if it is live.</p> <p>Check that the double pole circuit breaker located next to the power inlet is in “ON” position (i.e. “I” position). Try cycling to OFF position (i.e. “O” position) & then bring to ON (“I”) position.</p> <p>Test the voltage and verify that it is correct for your unit (refer to <i>Table 2</i>). If the outlet is dead, check the circuit breaker or fuses.</p> <p>The unit should not be connected to a GFCI (Ground Fault Circuit Interrupter) protected outlet as it may be subject to nuisance tripping.</p>
Temperature fluctuates	Temperature Control	Make sure that the control is set correctly. Refer to <i>Section 9.3</i> .
	Condenser clogged	Make sure the condenser and filter are clean. Refer to <i>Section 12.2</i> and <i>Section 12.3</i> .
	Solution bottle	Make sure the solution bottles for the temperature sensors are full. The solution is a 50/50 mixture of glycerin and distilled water.
	Other causes	If the temperature control is set correctly, the condenser is clean, but temperature continues to fluctuate, call an authorized service representative.
Low battery icon is lit	12V backup battery needs to be replaced.	Replace the battery. It is located on the top right hand side of the cabinet. Call an authorized service representative.
Condensation around door frame	Incorrect Perimeter Heater Duty Cycle	Increase the Perimeter Heater Duty Cycle, Refer to <i>Section 9.4</i> .
	Gaps exist in unit port holes	Ensure all port holes in the cabinet top, sides, and back are sealed properly to prevent warm airflow into the cabinet. Seal any gaps.
	Door seal is broken	Verify nothing is placed through the door seal such as a sensor. Check the door seal following instructions in <i>Section 12.5</i> .

Table 11. Troubleshooting Procedures

Problem	Cause	Solution
Unit is warm around door frame	Perimeter Heater is ON	This is a normal function of the unit and is a result of the perimeter heater to reduce condensation.
Unit warms up	Door is open	Make sure the door is completely closed.
	Door seal	Check the door seal, following instructions in <i>Section 12.5</i> .
	Warm product recently loaded in unit	Allow ample time to recover from loading warm product.
	Power supply	Check for proper voltage to the unit. If there is no voltage to the unit, call an electrician.
	Setpoints need to be adjusted	To adjust the setpoint, refer to <i>Section 9.3</i> .
	Faulty Safety Trip	Replace Sensor.
“E01” on display	Invalid Algorithm	Check to ensure the model type is set correctly in service mode. Refer to <i>Section 9.4</i>
“E02” on display	Control Probe Failure	Check for loose probe connector. Replace control probe.
“E03” on display	Defrost Probe Failure	Check for loose probe connector. Replace defrost probe.
“E05” on display	Ambient Probe Failure	Check for loose probe connector. Replace ambient probe.
“Err” on display	Upper Bottle Probe Failure	Check for loose probe connector. Replace upper bottle probe.
“---” on display	Lost Communication	Call customer service.

14 End of Life Care

Be sure to follow local regulations when disposing of an old unit. Some suggestions are listed in the following:

1. Remove items and defrost unit. Be sure to clean up any biological safety hazards.
2. Remove the cabinet door to help prevent entrapment inside of a unit.
3. Have a certified technician remove the refrigerant and compressor, then drain the compressor and oil from the system. Dispose of components following local regulations.

15 Warranty

Domestic Warranty • 2 Years Parts and Labor Plus an Additional 8 Years on V-Drive

International Warranty • 2 Years Parts Plus an Additional 8 Years on V-Drive

During the first twenty four (24) months from shipment, Thermo Fisher Scientific Inc, through its authorized Dealer or service organizations, will at its option and expense repair or replace any part found to be non-conforming in material or workmanship with an exception of V-drive which is covered for an additional 8 years (96 months) from the time of the shipment. Thermo Fisher Scientific Inc reserves the right to use replacement parts, which are used or reconditioned. Replacement or repaired parts will be warranted for only the unexpired portion of the original warranty.

This warranty does not apply to damage caused by (i) accident, misuse, fire, flood or acts of God; (ii) failure to properly install, operate or maintain the products in accordance with the printed instructions provided, (iii) causes external to the products such as, but not limited to, power failure or electrical power surges, (iv) improper storage and handling of the products, (v) use of the products in combination with equipment or software not supplied by Thermo Fisher; or (vi) installation, maintenance, repair, service, relocation or alteration of the products by any person other than Thermo Fisher or its authorized representative. To obtain proper warranty service, you must contact the nearest authorized service center or Dealer. Thermo Fisher Scientific, Inc's own shipping records showing date of shipment shall be conclusive in establishing the warranty period. At Thermo Fisher's option, all non-conforming parts must be returned to Thermo Fisher postage paid and replacement parts are shipped FOB Thermo Fisher's location.

Limitation of Liability

THIS WARRANTY IS EXCLUSIVE AND IN LIEU OF ALL OTHER WARRANTIES, WHETHER WRITTEN, ORAL, OR IMPLIED. NO WARRANTIES OF MERCHANTABILITY OR FITNESS FOR A PARTICULAR PURPOSE SHALL APPLY. THERMO FISHER DOES NOT WARRANT THAT THE PRODUCTS ARE ERROR-FREE OR WILL ACCOMPLISH ANY PARTICULAR RESULT.

THERMO FISHER SHALL NOT BE LIABLE FOR ANY INDIRECT OR CONSEQUENTIAL DAMAGES INCLUDING, WITHOUT LIMITATION, DAMAGES TO LOST PROFITS OR LOSS OF PRODUCTS.

WEEE Compliance

WEEE Compliance. This product is required to comply with the European Union's Waste Electrical & Electronic Equipment (WEEE) Directive 2012/19/EU. It is marked with the following symbol. Thermo Fisher Scientific has contracted with one or more recycling/disposal companies in each EU Member State, and this product should be disposed of or recycled through them. Further information on our compliance with these Directives, the recyclers in your country, and information on Thermo Scientific products which may assist the detection of substances subject to the RoHS Directive are available at www.thermofisher.com/WEEERoHS

Great Britain

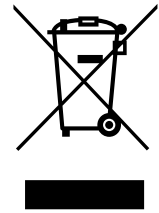

WEEE Konformität. Dieses Produkt muss die EU Waste Electrical & Electronic Equipment (WEEE) Richtlinie 2012/19/EU erfüllen. Das Produkt ist durch folgendes Symbol gekennzeichnet. Thermo Fisher Scientific hat Vereinbarungen getroffen mit Verwertungs-/Entsorgungsanlagen in allen EU-Mitgliederstaaten und dieses Produkt muss durch diese Firmen verwertet oder entsorgt werden. Mehr Informationen über die Einhaltung dieser Anweisungen durch Thermo Scientific, die Verwerter und Hinweise die Ihnen nützlich sein können, die Thermo Fisher Scientific Produkte zu identifizieren, die unter diese RoHS. Anweisung fallen, finden Sie unter www.thermofisher.com/WEEERoHS

Deutschland

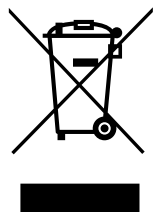

Conformità WEEE. Questo prodotto deve rispondere alla direttiva dell'Unione Europea 2012/19/EU in merito ai Rifiuti degli Apparecchi Elettrici ed Elettronici (WEEE). È marcato col seguente simbolo. Thermo Fisher Scientific ha stipulato contratti con una o diverse società di riciclaggio/smaltimento in ognuno degli Stati Membri Europei. Questo prodotto verrà smaltito o riciclato tramite queste medesime. Ulteriori informazioni sulla conformità di Thermo Fisher Scientific con queste Direttive, l'elenco delle ditte di riciclaggio nel Vostro paese e informazioni sui prodotti Thermo Scientific che possono essere utili alla rilevazione di sostanze soggette alla Direttiva RoHS sono disponibili sul sito www.thermofisher.com/WEEERoHS

Italia

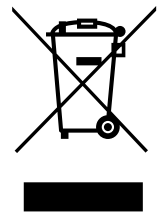

Conformité WEEE. Ce produit doit être conforme à la directive euro-péenne (2012/19/EU) des Déchets d'Equipements Electriques et Electroniques (DEEE). Il est marqué par le symbole suivant. Thermo Fisher Scientific s'est associé avec une ou plusieurs compagnies de recyclage dans chaque état membre de l'union européenne et ce produit devrait être collecté ou recyclé par celles-ci. Davantage d'informations sur la conformité de Thermo Fisher Scientific à ces directives, les recycleurs dans votre pays et les informations sur les produits Thermo Fisher Scientific qui peuvent aider la détection des substances sujettes à la directive RoHS sont disponibles sur www.thermofisher.com/WEEERoHS

France

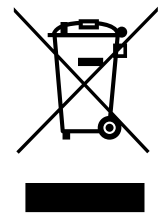



Thermo Fisher Scientific Inc.

275 Aiken Road
Asheville, NC 28804
United States

www.thermofisher.com

327930H01 Rev. G

thermoscientific

Contact Us

North America: 866-984-3766

Europe: France +33 2 2803 2180 Germany +49 9184 90 9640 UK/Ireland + 44 870 609 9203

Asia: China +86 21 6865 4588 India 1800 22 8374 Japan +81 45 453 9220