

KDS Legato 100 Series

USER'S MANUAL

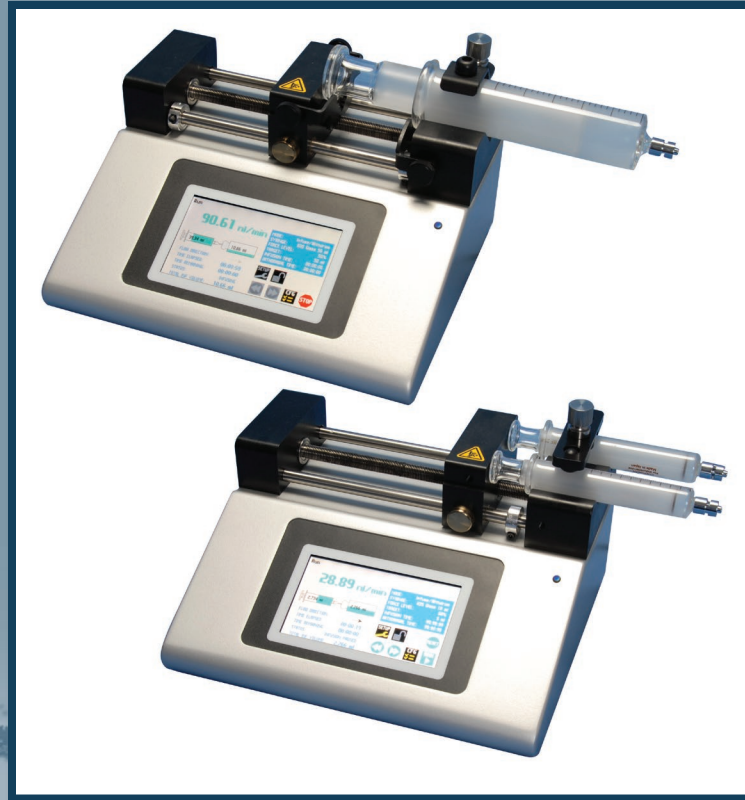

KDS LEGATO 100 SERIES

kdScientific

www.kdscientific.com

Table of Contents

SUBJECT	PAGE NO.
General Information	6
Safety Information.....	6
Warranty and Repair Information.....	7
Manual Description	7
Warranty.....	7
Repair Facilities and Parts	7
Serial Numbers	7
Calibrations	7
Specifications	8
Product Overview	10
Pump Models	11
Legato 100 Series Touchscreen Button Reference	12
Selecting an Item from a Menu List.....	13
Messages	13
Entering Values	13
Operating Instructions	14
Power Connections.....	14
Syringe Loading.....	15
Configuring the KDS Legato 100 Series.....	16
Selection Mode.....	16
Syringe Selection	17
Flow Rate Selection	18
Target Volume/Time Selection	19
Previewing the Configuration	20

SUBJECT	PAGE NO.
Configuring the Pump's General Parameters.....	20
Setting the Audible Alarms.....	21
For Near End of Run Selection.....	22
Locking the Touchscreen.....	23
Setting the Force Limits.....	24
Setting the Display Brightness.....	25
Setting the Pump Address.....	26
Setting the RS 232 Baud Rate.....	26
Resume Run on Power Loss.....	27
Setting and Viewing Pump Information.....	27
Operating the KDS Legato 100 Series.....	28
Running the Pump.....	29
Custom Program Workflow.....	30
Step-by-Step Operating Example.....	31
Configuring Custom Programs.....	32
Configuring New Custom Program.....	32
Setting a Delay.....	34
Setting a Delay for Program Operation.....	34
Creating a Custom New Program.....	35
To Create a New User-Defined Program.....	35
Modifying an Existing/User-Defined Program.....	37
Changing the Order of Steps in a Program.....	37
Deleting a Step from a Program.....	37
Defining Program Step Parameters.....	37
Pump Operation Profiles.....	38
Constant Rate Profile.....	39
Ramp Profile.....	40

SUBJECT	PAGE NO.
Delay	41
Repeat Step	41
Stop	42
I/O Event Triggers	43
I/O (OUT) Trigger (OUT)	44
I/O (IN) Event	45
Managing Legato 100 Series Programs	46
Saving a Copy of a Program	46
Renaming a Program	46
Appending a Program	47
Deleting a Program	47
Program Export and Import	48
Transfer a Program between Pumps	48
Exporting a Program to an External Computer	49
Importing a Program from an External Computer	49
External Pump Control	50
Setting Up HyperTerminal	50
Pump Chain Commands	51
System Commands	52
Run Commands	54
Rate Commands	54
Volume Commands	55
Time Commands	56
Digital I/O Commands	57
Internal Commands	57
Error Codes	58

SUBJECT	PAGE NO.
Appendices	60
Appendix A: Syringe Volume/Diameter Reference Table.....	60
Appendix B: Min/Max Flow Rates.....	61
Appendix C: External Connections.....	63
User I/O Connector Specifications.....	63
Utilizing USB Interface.....	64
RS-485	66
Appendix D: Maintenance	67
Maintenance.....	67
Upgrading Legato 100 Series Software.....	68
Troubleshooting	69
Appendix E: Ordering Information	70

General Information

SAFETY INFORMATION

Please read the following safety precautions to ensure proper use of your syringe pump. If the equipment is used in a manner not specified, the protection provided by the equipment may be impaired.

To Prevent Hazard or Injury:

USE PROPER POWER SUPPLY

The pump is supplied with an approved power supply and line cord. To maintain the safety integrity of the device, use only the following power supplies:

Cui Inc.

Model: 3A – 242DB24
Output: 24V – 1.0A
Input: 100–240V~50–60 Hz 0.8A

Globtek Inc.

Model: GT–41062–T3
Output: 24V – 0.75A
Input: 100–240V~50–60 Hz 0.6A

USE PROPER LINE CORD

Use only the specified line cord for this product and make sure line cord is certified for country of use. The operating voltage range for the KDS Legato 100 Series is 12-30 VDC. The universal power supply operating voltage range is 100-240 VAC, 50-60 Hz.

GROUND THE PRODUCT

This product is grounded through the grounding conductor of the power cord. To avoid electric shock, the grounding conductor must be connected to earth ground. Before making any connections to the input or output terminals of the product, ensure that the product is properly grounded.

MAKE PROPER CONNECTIONS

Make sure all connections are made properly and securely. Any signal wire connections to the unit must be no longer than 3 meters.

OBSERVE ALL TERMINAL RATINGS

Review the operating manual to learn the ratings on all connections.

AVOID EXPOSED CIRCUITRY

Do not touch any electronic circuitry inside of the product.

AVOID PINCH HAZARD

A pinch hazard may exist between the pusher block and end blocks. Avoid placing fingers between these points while the pump is running.

DO NOT OPERATE WITH SUSPECTED FAILURES

If damage is suspected on or to the product do not operate the product. Contact qualified service personnel to perform inspection.

ORIENT THE EQUIPMENT PROPERLY

Do not orient the equipment so that it is difficult to operate the disconnection device.

PLACE PRODUCT IN PROPER ENVIRONMENT

Review the operating manual for guidelines for proper operating environments.

OBSERVE ALL WARNING LABELS ON PRODUCT

Read all labels on product to ensure proper usage.



CAUTION
Refer to Manual



*Protective Ground
Terminal*

WARRANTY AND REPAIR INFORMATION



CAUTION: REFER TO SAFETY INFORMATION AND SETTING UP THE KDS LEGATO 100 SERIES BEFORE PLUGGING IN THE PUMP.

Manual Description

This manual is designed to provide all operational and program information required to operate and maintain the KDS Legato 100 Series pumps. The functions and features are described in the Technical Specifications section.

Warranty

KD Scientific warrants this instrument for a period of one year from date of purchase. At its option, KD Scientific will repair or replace the unit if it is found to be defective as to workmanship or materials. This warranty does not extend to damage resulting from misuse, neglect or abuse, normal wear and tear, or accident. This warranty extends only to the original consumer purchaser.

IN NO EVENT SHALL KD SCIENTIFIC BE LIABLE FOR INCIDENTAL OR CONSEQUENTIAL DAMAGES. Some states do not allow the exclusion or limitation of incidental or consequential damages so the above limitation or exclusion may not apply to you. **THERE ARE NO IMPLIED WARRANTIES OF MERCHANTABILITY, OR FITNESS FOR A PARTICULAR USE, OR OF ANY OTHER NATURE.** Some states do not allow this limitation on an implied warranty, so the above limitation may not apply to you.

If a defect arises within the warranty period, promptly contact **KD Scientific, 84 October Hill Road, Holliston, Massachusetts 01746** at 1-508-429-6809. Email address is info@kdsscientific.com. Goods will not be accepted for return unless an RMA (returned materials authorization) number has been issued by our customer service department. The customer is responsible for shipping charges for non-warranty repairs. Please allow a reasonable period of time for completion of repairs or replacement. If the unit is replaced, the replacement unit is covered only for the remainder of the original warranty period dating from the purchase of the original device.

This warranty gives you specific rights, and you may also have other rights which vary from state to state.

Repair Facilities and Parts

KD Scientific stocks replacement and repair parts. When ordering, please describe parts as completely as possible, preferably using a part number obtained from our Customer Service department. If practical, enclose a sample part or sketch. We offer a complete reconditioning service.

Serial Numbers

All inquiries concerning our product should refer to the serial number of the unit, located on the rear panel.

Calibrations

All electrical apparatus are calibrated at rated voltage and frequency. While the flow and volume will stay calibrated, the peak pressure may vary. KD Scientific recommends an annual calibration of the pump.



CAUTION: For research use only. Not for clinical use on patients.

Specifications	Legato 100, 101, 110, 111	Legato 180
Accuracy	± 0.5%	± 0.35%
Reproducibility	± 0.05%	± 0.05%
Syringes (Min./Max.)	0.5 µl / 60 ml (10 ml dual)	0.5 µl / 10 ml
Flow Rate:		
Minimum (0.5 µl syringe)	1.26000 pl/min	0.54000 pl/min
Maximum (10 ml syringe)	26.0170 ml/min	11.7027 ml/min
Maximum (60 ml syringe)	88.4040 ml/min	N/A
Display	4.3" WQVGA TFT Color Display with Touch Screen	4.3" WQVGA TFT Color Display with Touch Screen
Non-Volatile Memory	Stores all settings	Stores all settings
Connectors:		
RS-485	IEEE-1394, 6 pos	IEEE-1394, 6 pos
USB	Type B	Type B
I/O & TTL	15 pin D-Sub Connector	15 pin D-Sub Connector
Footswitch	mini phone jack	mini phone jack
Linear Force (Max)	13.6 kg (30 lbs) @ 100% Force Selection	13.6 kg (30 lbs) @ 100% Force Selection
Drive Motor	0.9° Stepper Motor	0.9° Stepper Motor
Motor Drive Control	Microprocessor with 1/16 microstepping	Microprocessor with 1/16 microstepping
Number of Microsteps per one rev. of Lead Screw	15,360	20,480
Step Resolution	0.069 µm/µstep	0.031 µm/µstep
Step Rate:		
Minimum	27.5 sec/µstep	27.5 sec/µstep
Maximum	26 µsec/µstep	26 µsec/µstep
Pusher Travel Rate:		
Minimum	0.15 µm/min	0.02 µm/min
Maximum	159.00 mm/min	71.55 mm/min
Input Power	12-30 VDC	12-30 VDC
Input Power Connection	2.5mm ID x 5.5mm OD male plug	2.5mm ID x 5.5mm OD male plug
Power Supply	100-240 VAC, 50-60 Hz, 8 Watts Universal Power Supply, Use Only a KD Scientific Approved Power Supply and Line Cord	100-240 VAC, 50-60 Hz, 8 Watts Universal Power Supply, Use Only a KD Scientific Approved Power Supply and Line Cord
Dimensions	22.6 x 19.05 x 15 cm (9 x 7.5 x 5 in)	22.6 x 19.05 x 15 cm (9 x 7.5 x 5 in)
Weight	2.66 kg (5.9 lbs)	2.66 kg (5.9 lbs)

Specifications	Legato 100, 101, 110, 111	Legato 180
Atmospheric Specifications:		
Operating Temperature	4°C to 40°C (40°F to 104°F)	4°C to 40°C (40°F to 104°F)
Storage Temperature	-10°C to 70°C (14°F to 158°F)	-10°C to 70°C (14°F to 158°F)
Operating Humidity	See Chart Below	See Chart Below
Storage Humidity	20% to 80% RH, non condensing	20% to 80% RH, non condensing
Method of Operation	Continuous	Continuous
Classification	Class I	Class I
Pollution Degree	1	1
Installation Category	II	II
Supplier Name	KDS	KDS
Supplier Address	84 October Hill Rd., Holliston, MA 01746	84 October Hill Rd., Holliston, MA 01746
Supplier Phone Number	(508) 429-6809	(508) 429-6809
Regulatory Certifications	CE, ETL, (UL, CSA), CB Scheme, EU RoHS, WEEE	CE, ETL, (UL, CSA), CB Scheme, EU RoHS, WEEE
Safety Declarations	ANSI/UL 61010-1:CAN/CSA C22.2 No. 61010-1:IEC 61010-1:CB Scheme	ANSI/UL 61010-1:CAN/CSA C22.2 No. 61010-1:IEC 61010-1:CB Scheme
EMC Declaration	IEC 61326-1	IEC 61326-1

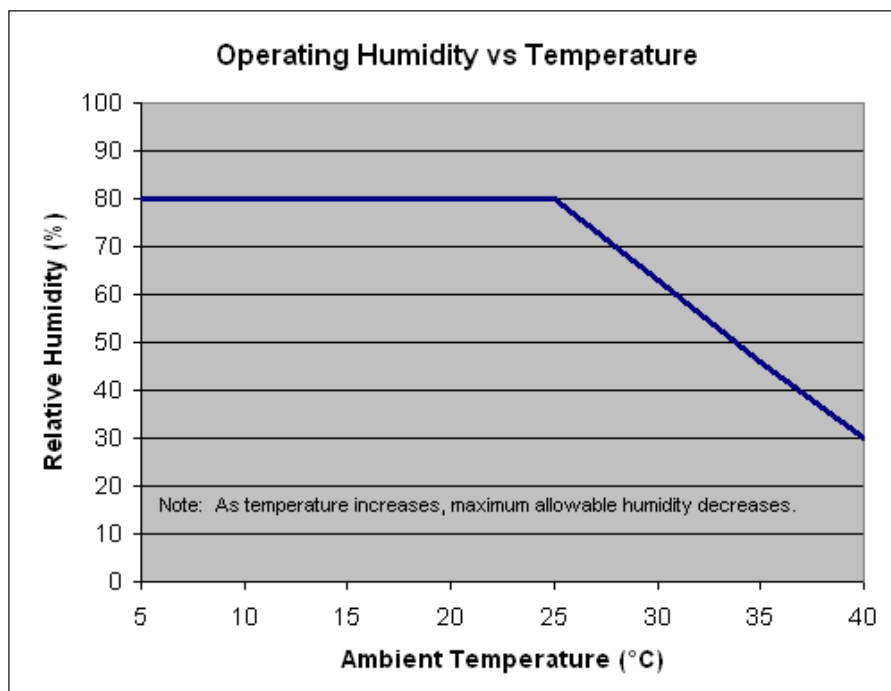

Product Overview



The KD Scientific Legato 100 Series is the next generation of syringe pumps. The series offers unparalleled ease of use through the high resolution color touch screen user interface. The full touch screen interface enables the user to quickly create configurations and recall them for easy use. The TFT color display presents all the pump operating parameters on an easy to view run screen.

The password feature prevents accidental configuration changes ensuring the programs integrity is retained. Programs can also be set to be started on a time delay for unattended operation.

An led light on the front panel makes it easy to see if the pump is running. Once the pump starts to run, the display shows the pump is running and the LED turns on. This will make it easy to see the pump's status.

The pumps are versatile and can be interconnected through the RS485 interface. Legato 100 Series models can be mixed and matched in the daisy chain offering maximum flexibility. Up to 99 pumps can be linked together through the RS485 interface. This interface is easy to use provided each pump is assigned its own unique pump address.



For limited laboratory space the Legato 100 Series can be placed on its side to reduce the footprint by 55%. The display also tilts with the change to allow the user to operate the pump vertically.

Notifications and error messages are displayed for the user to acknowledge, eliminating any guesswork about problems.

Flow performance is optimized with a small step angle stepping motor that drives a precision lead screw and pusher block. The syringe mechanism is easy to use and securely holds the syringes for smooth flow performance.

Advanced microstepping techniques are employed to further reduce the step angle to eliminate flow pulsation. The accuracy is $\pm 0.5\%$ (Legato 100, 101, 110 and 111), or $\pm 0.35\%$ (Legato 180) with 0.05% reproducibility. A wide dynamic flow range can be programmed into the pump. Flow rates are selectable with user selected engineering units from ml, μ l, nl pl, and hours, minutes and seconds.

Up to 30 lbs of linear force is available. This force is user adjustable to ensure the right force is applied for the various syringe sizes.

The superior design of the full metal chassis provides noise isolation and anti-vibration features for increased reliability. The spill dam is designed to prevent fluids from ingressing into the sealed display. All syringe racks are hardened rolled steel and will not deform with pressure.

Easy external connections to a computer or other control devices are made through USB interface. Simple ASCII commands make communication with the pump easy. For direct control of the pump, the user can use the I/O interface (15pin Dsub). A trigger output and a trigger input in for external events such as a process parameter is met. The footswitch input will allow the control of the pump through an external device. The unit also has an output for run indication allowing connection to a remote light.

Single or dual syringes models are available. Complete flexibility is offered with the user able to use most manufacturer's syringes with sizes ranging from 0.5 ul to 60 ml.

The infuse/withdraw programmable models Legato (110, 111 and 180) offer maximum flexibility and capability for configuring and running different programs. Up to 2 programs of 50 steps each can be configured and stored in the unit, and recalled quickly with the touch of a button. The programs are identified with a 15 character alphanumeric name for easy identification and can be stored on the computer and downloaded at future dates. A relative clock is available to start and stop programs based on time. Extensive programming options allow the user to duplicate configurations, append one configuration to another, rename programs, delete programs, export programs to a PC or export a program to another pump. This feature can ensure consistency and accuracy of multiple pumps.

Preprogrammed profiles include Constant Rate and Ramp. These standard profiles make configuration easy to set up. If more complexity is needed the user can select from advanced programming options including:

- Time delays
- Repeating steps
- Stopping the pump
- Triggering the pumps TTL output
- Accepting an event input in such as a user touch
- Events can trigger the pump to withdraw or infuse

The pump Information/setup screen shows the pump's software version, and lubrication intervals. The pump's alarm configurability includes alarms for near end of run (user selectable), completion of run, power up, keypad clicks and stall detection.

Pump Models

The Legato 100 Series is available in 5 different configurations.

Legato 100 – Single syringe infuse only.

Legato 110 – Single syringe infuse/withdraw with program option for 2 programs, 50 steps each..

Legato 101 – Dual syringe infuse only. Syringe size 0.5 μ l to 10 ml.

Legato 111 – Dual syringe infuse/withdraw with program option for 2 programs, 50 steps each.

Legato 180 – Dual syringe infuse/withdraw optimized for low flow with program option for 2 programs, 50 steps each. Syringe size 0.5 μ l to 10 ml.

LEGATO 100 SERIES TOUCHSCREEN BUTTON REFERENCE

The following buttons are part of the KDS Legato 100 Series software:



Settings: Access the settings menu used to adjust the following parameters: Audible Alarms, Pusher Block Force, Display Brightness, etc.



Fast Forward: Advances the Pusher Block in the forward (infuse) direction (press & hold).



Fast Reverse: Advances the Pusher Block in the reverse (withdraw) direction (press & hold).



Accept: Used to accept the parameters/settings on a screen and return to previous screen in the menu.



Cancel: Used to cancel any changes/entries on a screen and return to the previous screen in the menu.



Set Delay Parameters: Used to set the time values for delayed operation. This permits the pump to start automatically at a preset time interval.



Set Delay Parameters: Indicates the Delay Timer has been set. The pump will start automatically.



Run Preview: Access the Run Preview screen that shows a summary operating parameters.



Run/Resume: Used to Run or Resume a Program.



Re-Run: Clears counters/timers (except the Total Infused Volume counter) and runs the selected program from the beginning.



Stop: Used to stop running a Program.



Reset: Resets all counters/timers.



Minimum Value Allowed: Used to select minimum value allowed.



Maximum Value Allowed: Used to select maximum value allowed.



Configure: Used to set up the program.



Back: Used to call the Mode and Programs menu.



Page Down: Used to page down in a display list.



Page Up: Used to page up in a display list.



Line Up: Used to scroll up in a display list.



Line Down: Used to scroll down in a display list.



Insert Step: Used to insert a new Step in a Program while editing/creating the Program. The new Step is inserted after the Step that is currently selected.



Delete Step: Used to delete the selected Step in a Program while editing/creating the Program. To confirm deletion, you must select the Delete Step button a second time.



Move Step Up: Moves the currently selected Step in a Program up one position in the Program Order (e.g. Step 3 becomes Step 2).



Move Step Down: Moves the currently selected Step in a Program down one position in the Program Order (e.g. Step 2 becomes Step 3).



Copy Step: Creates a duplicate (copy) of the currently selected Step in a Program and inserts it as the last Step in the Program being created/edited.



Password Protection Off: Indicates that the pump is currently unlocked. Pressing the button twice locks the Touchpad.



Password Protection On: Indicates that the pump is currently locked. Press the button and enter password to unlock the Touchpad.



File Options: Access the File Options menu that is used to manage the list of Programs and to export Program information to an externally linked pump or to a connected computer.

Selecting An Item From a Menu List

Selecting items is easy with the Legato 100 Series.

Touch the item to select/highlight the item, then touch again to select it or press 

Canceling a Selection

Canceling selections is easy.

Press 

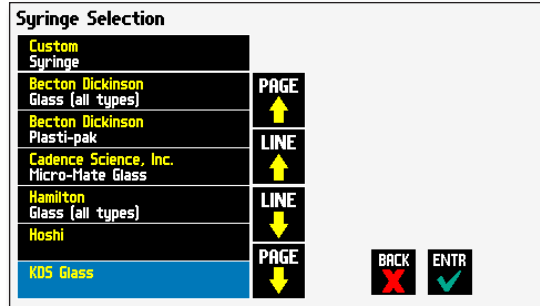

Messages

There are different types of messages. Error messages are shown in yellow.

- Critical
- Run-mode
- Program
- Set-up

Notices, alarms, confirming, and verified messages are show in green.

- Alarms
- Confirm
- Verified

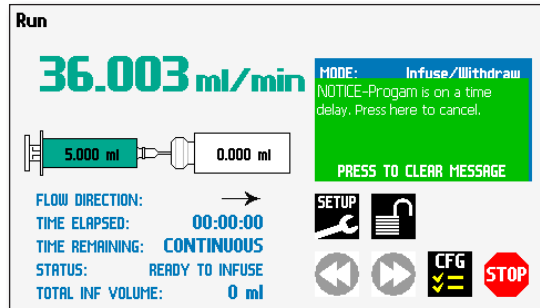
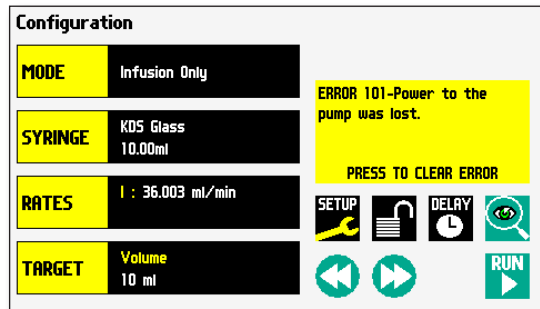

Entering Values

Entering new values is easy.

Use the keypad to enter the number

Backspace Key

Decimal point

Accept the value and go back up to the previous screen.

Cancel and go back to the previous screen.

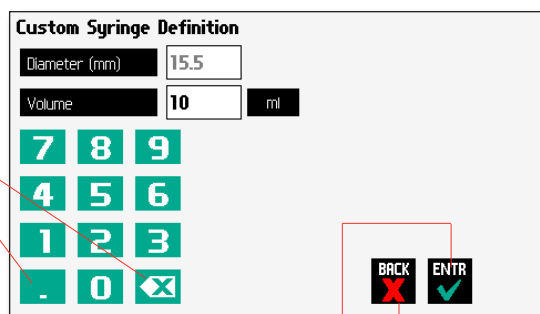

OPERATING INSTRUCTIONS

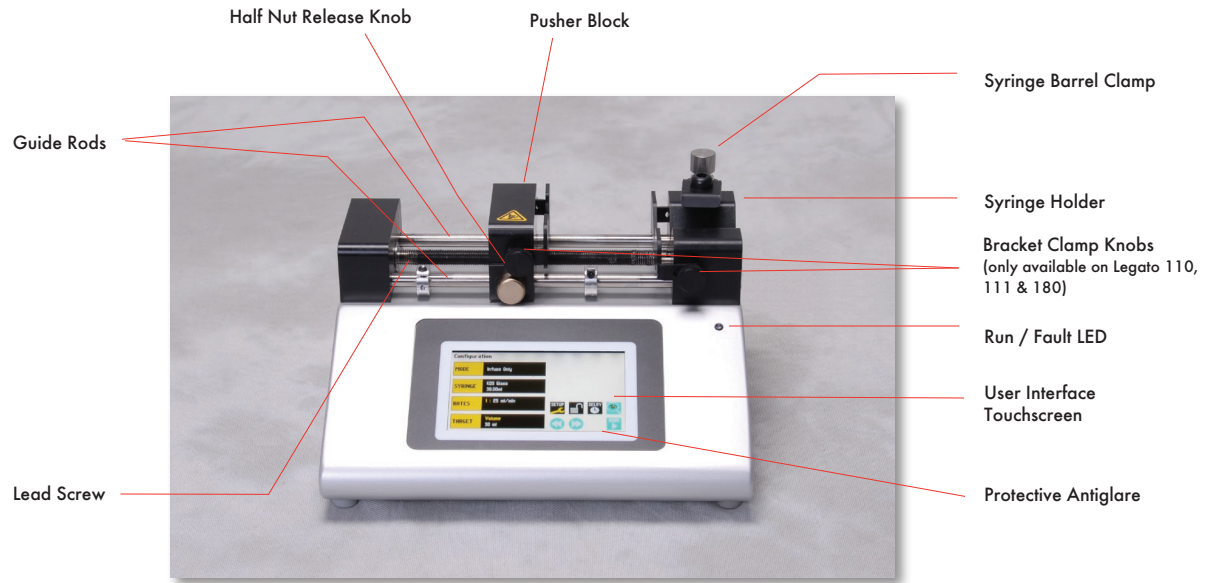

Legato 110 syringe pump shown above

Close up view of the Legato 110 rear connections
(connections vary depending on model type)

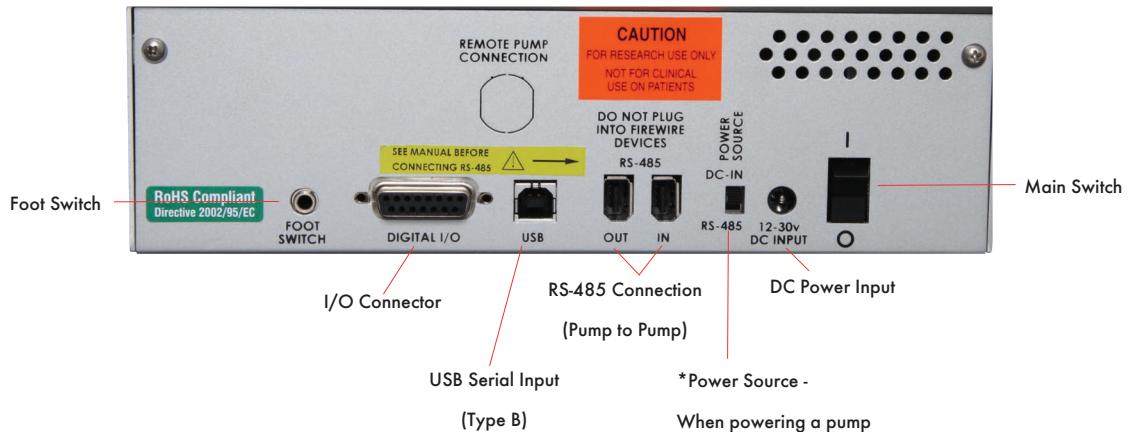

POWER CONNECTIONS

1. Plug the power supply into the pump.
2. Connect to a properly rated line cord. The Legato 100 Series power supply has a DC power input connector on the rear of the unit. The operating range for the Legato 100 Series series is 100 – 240 VAC, 50-60 Hz.
3. Turn on the main power switch.

CAUTION: Do not connect to firewire ports on a computer. Damage may occur to the pump or computer.

***Power Source -**
When powering a pump in a chain through an RS-485 cable, toggle switch to RS-485. Only one pump can be powered from the master through the RS-485.

SYRINGE LOADING

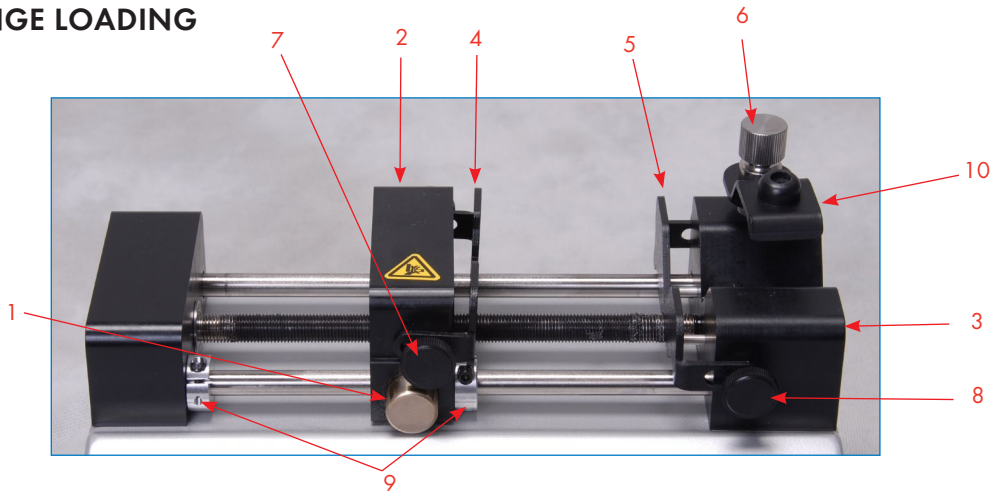

The Legato 100 Series can accommodate up to two syringes. Depending on the mechanism, any type of syringe, glass, plastic or stainless steel can be used. The pump can accommodate from 0.5 µl to 60 ml single syringe and 0.5 µl to 10 ml dual syringe. The syringe barrel clamp should be flipped for syringes smaller than 30 ml. For syringes larger than 30 ml, the syringe clamp should be used as shown.

1. Squeeze the release button (1) and move the pusher block (2) to the approximate length of the syringe.
2. Unscrew the bracket clamping knobs (7,8) to loosen the retaining brackets (4,5) on the pusher block (2) and the syringe holder block (3).
3. Unscrew the syringe barrel clamp (10) by unscrewing the syringe barrel clamp knob (6).
4. Place the syringe on the syringe holder block (3). Ensure the barrel flange is within the syringe holder's block's retaining bracket (5) and the plunger flange is in the pusher block's retaining bracket (4).

5. Screw down the syringe clamp knob (6) until the syringe barrel clamp (10) is tight against the syringe barrel. Do not overtighten, especially when using glass syringes.
6. Secure the syringe flanges by pushing the retaining brackets (4,5) tightly against the syringe flanges using the bracket clamping knobs (7,8). The syringe plunger should be secured by the pusher block retaining bracket and the flange of the syringe should be secured by the syringe holder block retaining bracket.
7. Tighten the mechanical stop collars (9) on the pump to prevent excess pusher block travel.



NOTE: The syringe barrel clamp (10) [single only] may need to be flipped depending on your syringe size. To do so, completely unscrew and remove the syringe barrel clamp knob from the syringe block. Then remove lock nut (11). Flip the bracket and reassemble.



NOTE: Syringe brackets (4 & 5) are only available on Legato 110, 111 & 180.

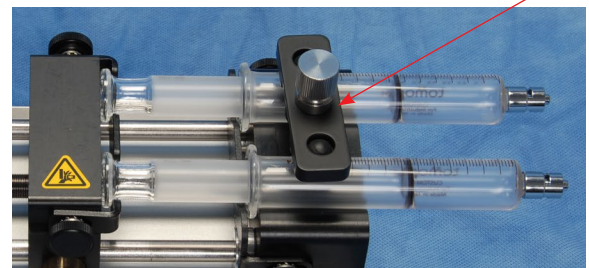
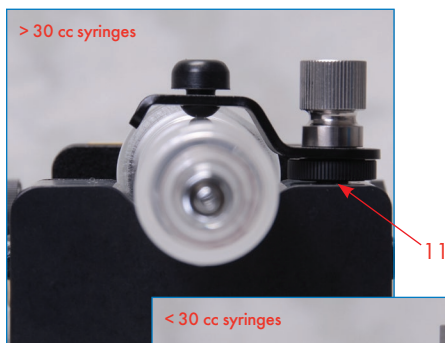

10 Dual Syringe Clamp



CAUTION: Be sure mechanical stop collars are positioned properly to prevent the plunger from bottoming out on glass syringes.



NOTE: For infuse/withdraw models, make sure the plunger is secured in the retaining bracket and the barrel of the syringe is secured in the retaining bracket.

Configuring the KDS Legato 100 Series

The KDS Legato 100 Series program is easy to set up.

The Legato 100 Series is easily configured. When the unit is powered up, the Configuration Screen will be displayed.

Configuration

MODE Infuse Only

SYRINGE KDS Glass 10.00ml

RATES I : 36.003 ml/min

TARGET Volume 5 ml

Annotations: Select Mode, Select Syringe Manufacturer Size, Select Flow Rates, Select Target Volume, Fast Reverse, Fast Forward, Press and hold to activate, General Pump Parameter Set-Up, Preview Program Jumps to Run Screen, Starts Pump & Jumps to Run Screen.

If you select infuse/withdraw or withdraw/infuse mode the configuration screen will have the continuous mode selection. (Press to toggle on/off)

Infuse/Withdraw models only. Continuous flow is an option on the display. In continuous mode, the pump will infuse then withdraw continuously or vice versa depending on which mode is selected. The pump will switch to withdrawal based on the target volume entered.

The total infuse volume will be displayed on the run screen as well as total elapsed time.

Configuration

MODE Infuse/Withdraw **CONT FLOW** ✓

SYRINGE KDS Glass 10.00ml

RATES I : 36.003 ml/min
W : 20 ml/min

TARGET Volume 5 ml

Mode Selection

In the Configuration Display select mode (available modes depend on the pump model)

- Infuse
- Withdraw
- Infuse/Withdraw
- Infuse/Withdraw (continuous)
- Withdraw/Infuse
- Withdraw/Infuse (continuous)
- Custom program

The Mode Selection Screen will be displayed. The available modes will be displayed based on the model of syringe pump.

Press the Mode to select

View programs up a page

Views up one program

Views down one program

View the programs down a page

Configuration

MODE Infuse Only

SYRINGE KDS Glass 10.00ml

RATES I : 36.003 ml/min

TARGET Volume 5 ml

Mode Selection

New Program

Infuse Only

Withdraw Only

Infuse/Withdraw

Withdraw/Infuse

1_PROGRAM Program

Navigation: PAGE, LINE, SETUP, FILE, ENTR

Syringe Selection

1. In the **Configuration Display** select the syringe button.

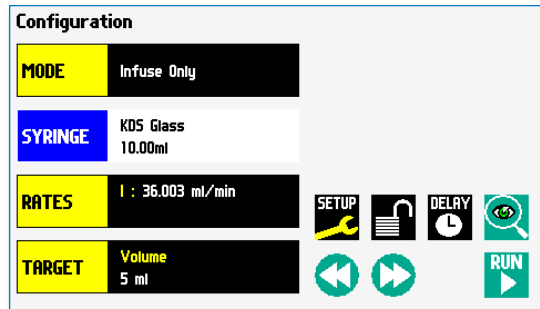

2. Select the manufacturer type. Then the available syringe sizes will be displayed. In this example we have selected a KDS 10ml Glass Syringe.

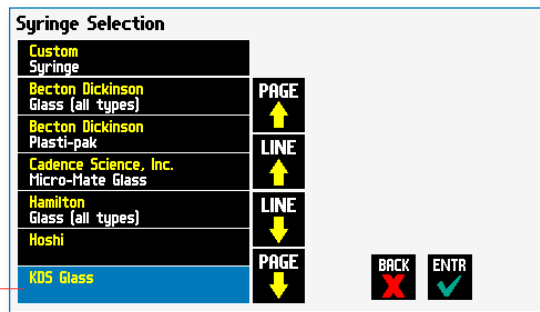

Press

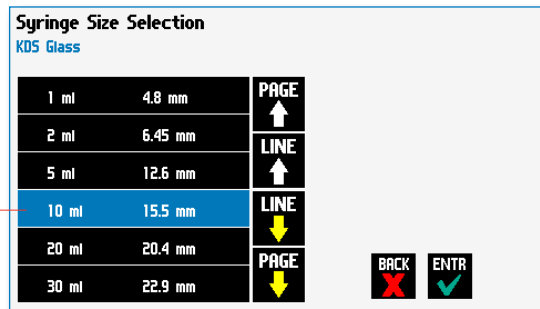

Press

3. For a Custom Syringe use this selection if syringe manufacturer is not listed.

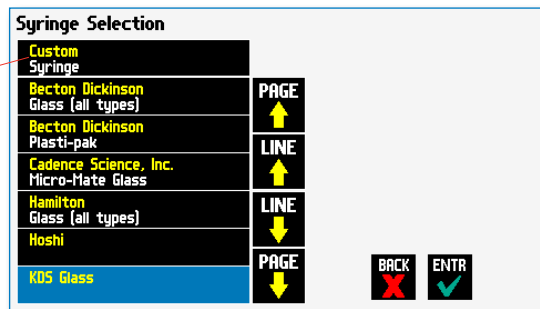

Press to enter a custom syringe

Custom Syringe Definition Display

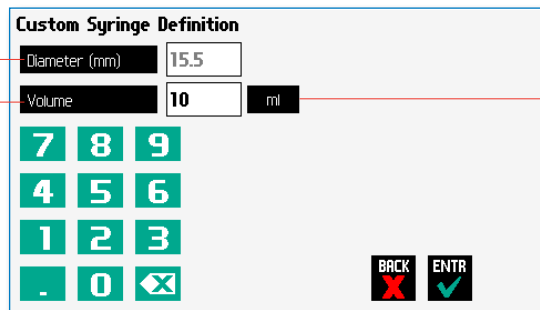

Press to enter the total syringe volume

Press to enter the inside diameter of the syringe

Press to change the units (µl, ml)

 **CAUTION:** BE SURE TO LOWER THE FORCE VALUE WHEN USING GLASS SYRINGES.

Flow Rate Selection

1. In the **Configuration Display** enter the flow rate(s). In this example we want to enter 36.003 ml/min.

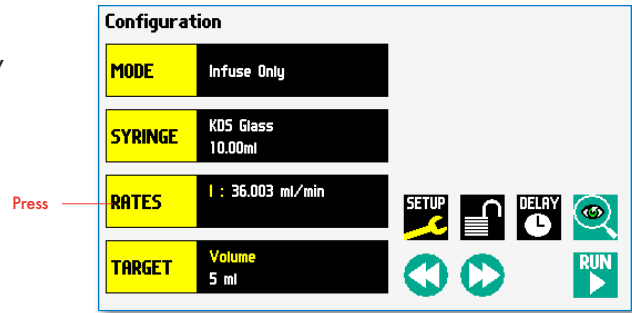

2. Depending on the Mode, the appropriate set rate screen will be displayed. To change the units, press the units.

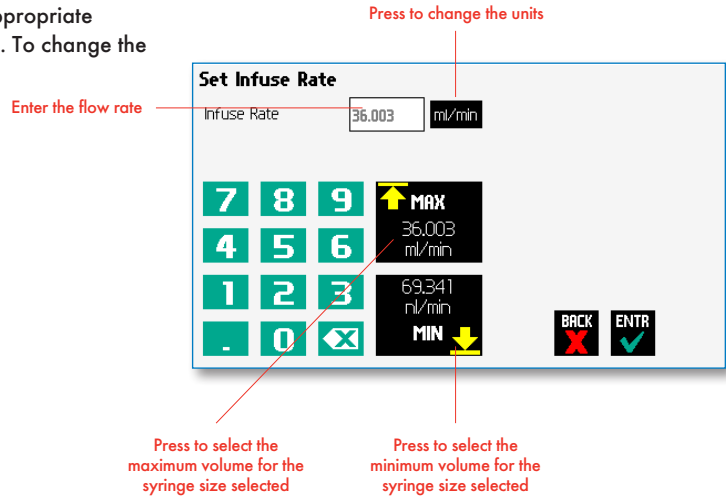

3. In the **Units Selection Display** select the volume and the time base.

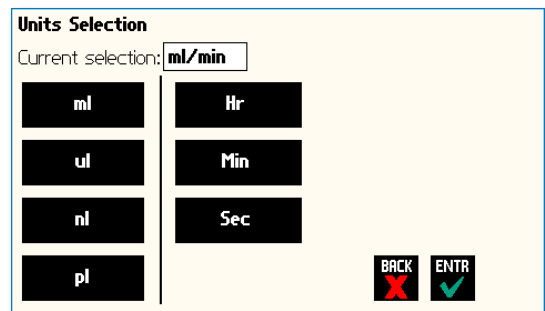

Target Volume/Time Selection

1. In the **Configuration Display** enter the target volume or time. In this example we want a volume of 5 ml.

 **NOTE:** Target time is only allowed in infusion only or withdrawal only modes.

2. Depending on the Mode either Target Volume (I/W or W/I) will appear or Target Volume or Target Time Selection (I only or W only).

 **NOTE:** For time enter h:m:s. or press again to select secs. Time is accurate to +/- 0.01secs. Remember to enter the :

3. To change the units, press the units.

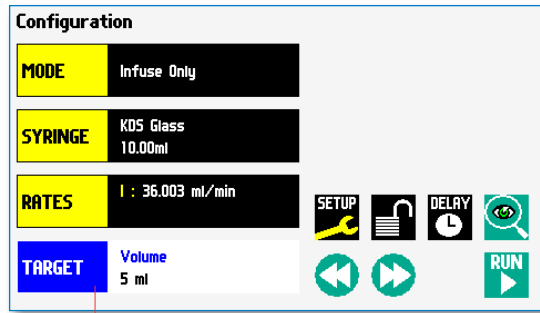

Press Here

Press to select target volume

Press to select target time

Press to select the maximum volume for the syringe size selected

Press to change the units

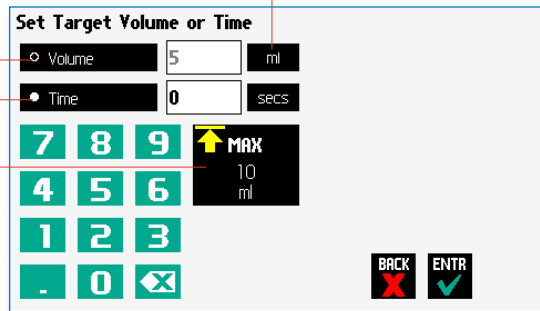

4. In the **Units Selection Display** select the volume units.

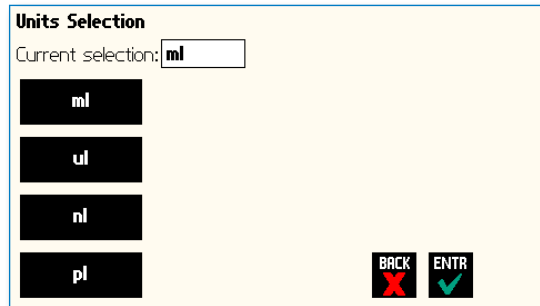

Previewing the Configuration

It is simple to view the Pump Configuration on the RUN display.

Press  to view Pump Configuration

After you have verified the configuration.
Press  to run the displayed configuration.

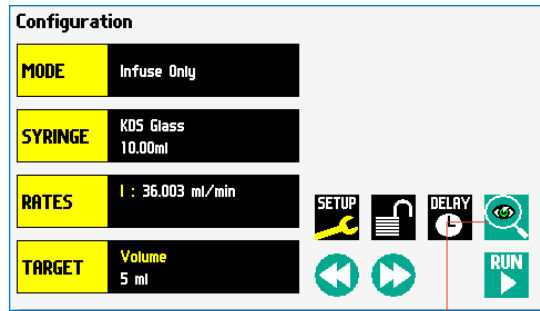

Press to preview configuration

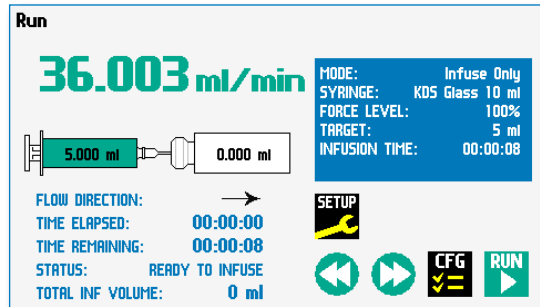

Configuring the Pump's General Parameters

The pump has basic parameters that should be configured during initial start-up. Once these parameters are entered they probably won't be changed.

To enter the set-up screen press 

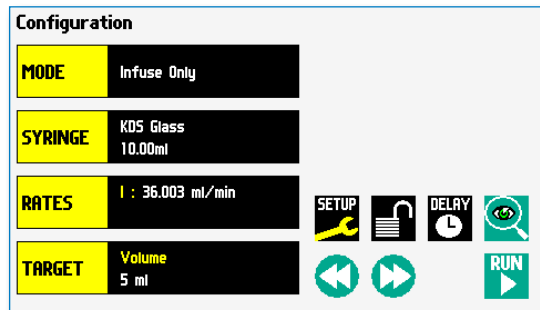

Setting the Audible Alarms

In the Set-up screen, press **Audible Alarms**.

Select the alarms, a check mark will indicate the alarms selected.

If these alarms are selected the pump will provide an audible alarm.

Accept the changes made by pressing **ENTR** and go back to the Set-up screen.



Cancel the changes made by pressing **BACK** and go back to the Set-up screen.

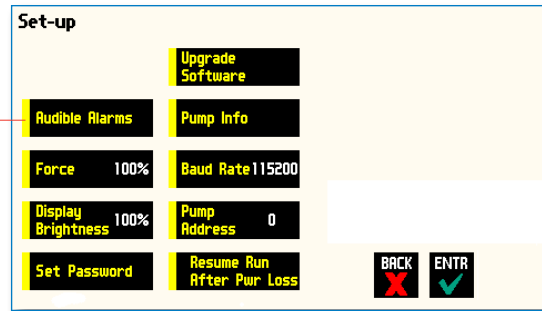

Press

End of Run - Alarm when the program is finished

Power Fail - Alarm when pump is power-cycled while running

Keypad Clicks - When the keypad is touched the unit will provide audible feedback

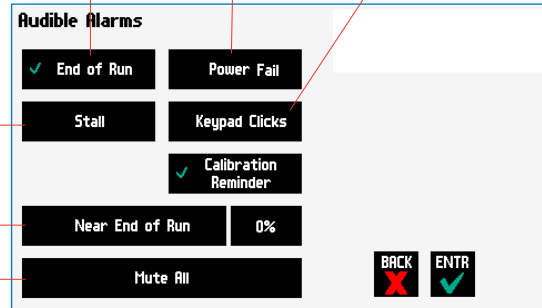

Stall - Motor stalls

Near End of Run - When the volume dispensed is reached for the specified %

Mute All - No audible sounds

For Near End of Run Selection

Select the % volume dispensed. For example, if you select 80%, the pump will sound an alarm (3 short beeps) when the 80% of the volume is dispensed.

Accept the changes made by pressing **ENTR** and go back to the Set-up screen.



Cancel the changes made by pressing **BACK** and go back to the Set-up screen.



Press to select % volume dispensed

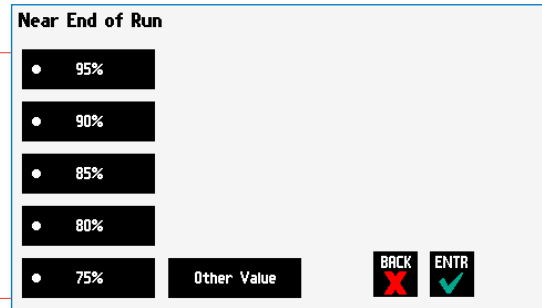

For a Custom %

Use this selection if the % is not listed.

Press **Other Value** to enter a custom %

Accept the changes made by pressing **ENTR** and go back to the Set-up screen.



Cancel the changes made by pressing **BACK** and go back to the Set-up screen.



Press to enter a custom %

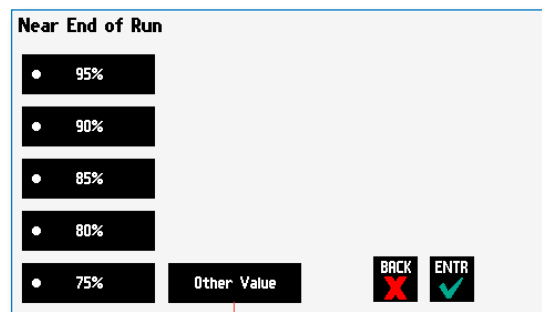

Enter the percentage.

Accept the changes made by pressing **ENTR** and go back to the Set-up screen.



Cancel the changes made by pressing **BACK** and go back to the Set-up screen.

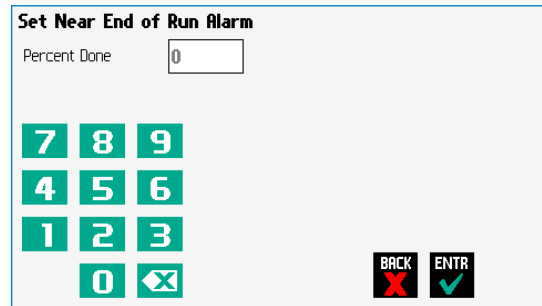

Locking the Touchscreen (Password Protection)

A touchscreen lock function can be enabled to prevent accidental operation or interruption of operation. Unlocking the touchscreen requires a password, defined by the user.

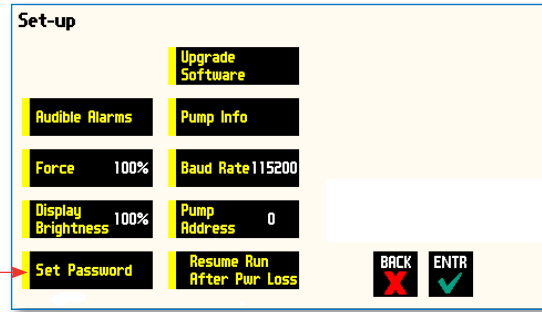

Setting the Password

To set the Password go to the Settings screen. Press the Set Password button.

Enter your desired password, up to 8 digits, and press the "ACCEPT" button.

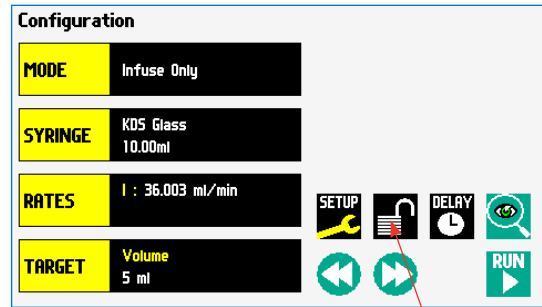

Turning the Touchscreen Lock on

Press the Lock button twice to lock the touchscreen.

Turning the Touchscreen Lock off

Press the "LOCK" button to bring up the Enter the Pump Password screen.

Enter your password and press the "ACCEPT" button.

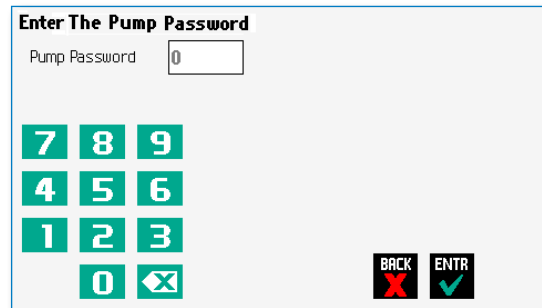

 **NOTE:** If you forget your password contact KD Scientific Technical Support at 508-429-6809.

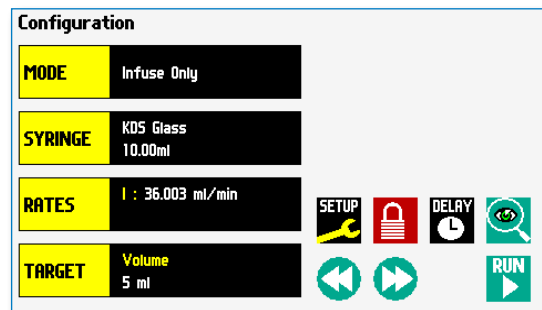

Setting the Force Limits

The maximum linear force of the syringe pump is 30 lbs or 13.6 kgs. This force is sufficient to damage delicate, low volume syringes, as well as many standard syringes if pumping viscous fluids. The % of maximum force applied by the pusher block can be changed.

In the set up screen, press **Force**.

 **NOTE:** A minimum value of approximately 30% is required to overcome friction forces in the mechanism. You may have to set the force level to a higher value depending on the backpressure/friction in your system.

Set the force level.

Press **Other Value** to enter a custom force %

Accept the changes made by pressing  and go back to the Set Force screen.

Cancel the changes made by pressing  and go back to the Set Force screen.

For a Custom Force %

Enter the percentage for custom force %

Accept the changes made by pressing  and go back to the Set Force screen.

Cancel the changes made by pressing  and go back to the Set Force screen.

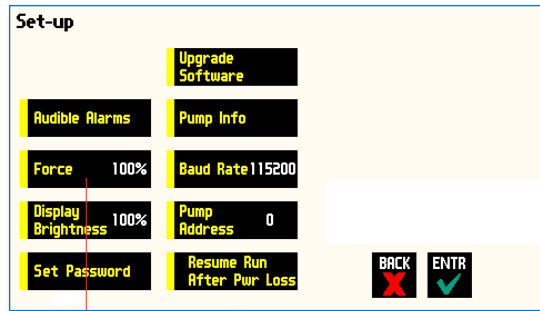

Press Here

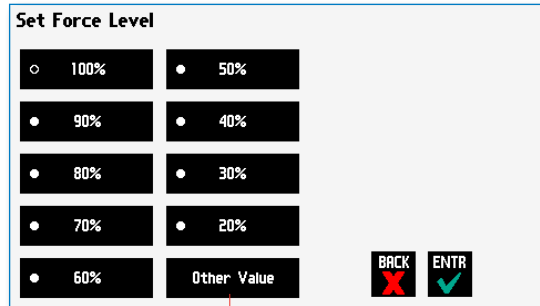

Press here to enter custom force %

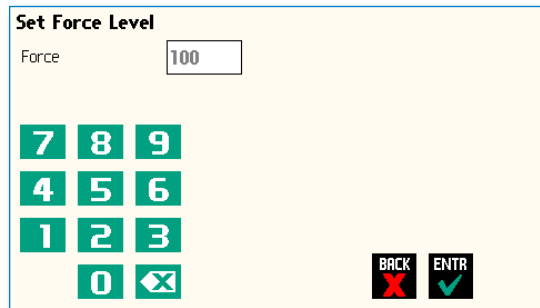

Suggested Force Level Settings for Common Syringes			
Syringe Type/Material	Capacity	Force Setting	Common Manufacturer(s)
Plastic Syringes	≤5 ml	50%	BD plastic, Sherwood, Airtite, Terumo
	>5 ml	100%	
Stainless Steel	All	100%	KDS, Cole-Parmer
Glass/Glass	≤20 ml	30%	KDS Glass, Cadence (Popper)
	>20 ml	50%	
Glass/Plastic	≤1000µl	30%	Hamilton, SGE
	≤5 ml	50%	
	>5 ml	100%	

Setting Display Brightness

The backlight can be adjusted.

In the Set-up screen, select **Display Brightness**

Press to select % Display Brightness

Select the % Display Brightness. For example, if you select 80%, the brightness of the display will be 80% of the maximum.

Accept the changes made by pressing **ENTR** and go back to the Set-up screen.

Cancel the changes made by pressing **BACK** and go back to the Set-up screen.

For a Custom Value

Use this selection if the % is not listed.

Press **Other Value** to enter a custom %

Enter the percentage.

Accept the changes made by pressing **ENTR** and go back to the Set-up screen.

Cancel the changes made by pressing **BACK** and go back to the Set-up screen.

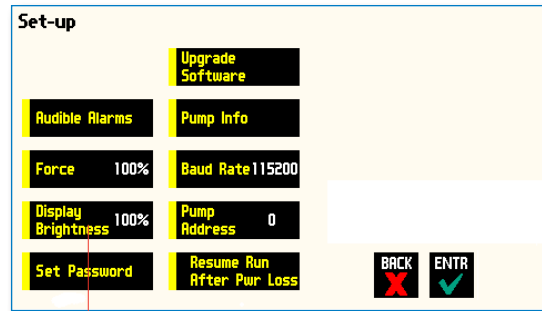

Press Here

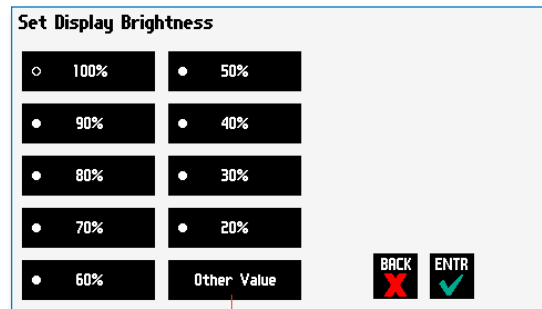

Press here for custom display brightness level

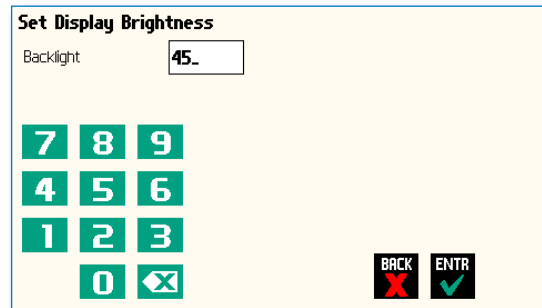

Setting the Pump Address

Up to 100 pumps can be linked together. Each pump can be given a unique address.

In the Set-up Screen press **Pump Address**.
Valid entries are 00 to 99.

Enter the pump address.

Accept the changes made by pressing and go back to the Set-up screen.



Cancel the changes made by pressing and go back to the Set-up screen.

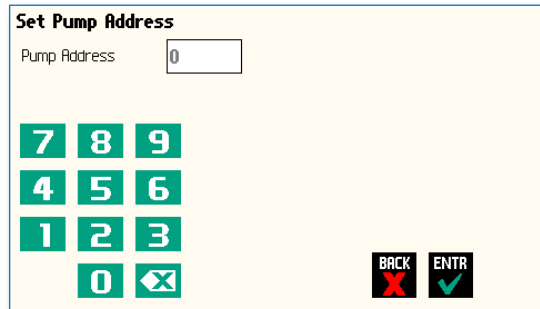
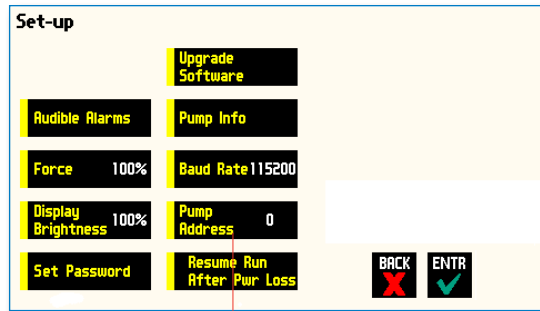

Setting the RS-232 Baud Rate

To adjust the baud rate from 9600 to 115,200: in the Set-up screen press **Baud Rate**

Select the Baud Rate.

Accept the changes made by pressing and go back to the Set-up screen.



Cancel the changes made by pressing and go back to the Set-up screen.

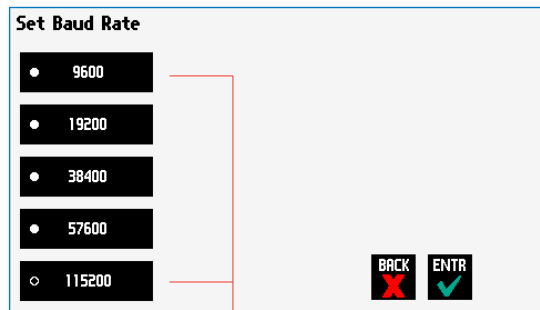
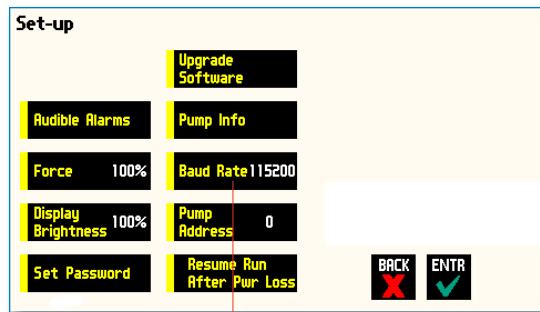

Press here to select Baud Rate

Resume Run on Power Loss

If Resume Run on Power Loss is selected the pump will power up running when power resumes.

NOTE: This feature is only valid in Infuse Only or Withdraw Only modes. This feature will only execute if the pump is running at the time when power is lost, and was running with no target set.

In the Set-up screen, select **Resume Run After Power Loss**

ENTR **✓** Accept the changes made and go back to the previous screen before Set-up mode was selected.

BACK **✗** Cancel and go back to the previous screen before Set-up mode was selected.

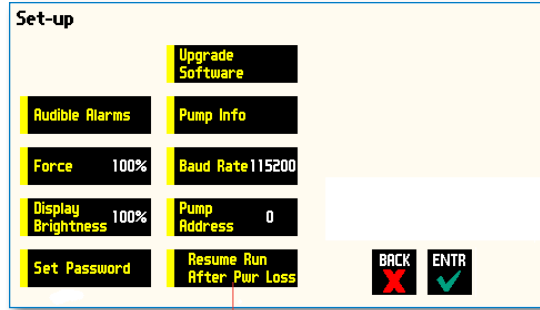

Press Here

NOTE: Elapsed Timers and Total Infused Volume will be reset when power resumes. Counters and timers information prior to loss of power are lost

Setting and Viewing Pump Information

The information on the pump's parameters are displayed in the Pump Information Screen.

In the Set-up screen, select **Pump Information**

The current information on the pump will be displayed.

- The Model type
- The Software Version
- The Maintenance Due
- The Current Pump Address

Press **Maintenance Reset** to reset the # of hours for maintenance. This will reset it to 100 hours.

Confirm the Maintenance Reset by pressing the **Maintenance Reset** again.

Accept the changes made by pressing **ENTR** **✓** and go back to the Set-up screen.

Cancel the changes made by pressing **BACK** **✗** and go back to the Set-up screen.

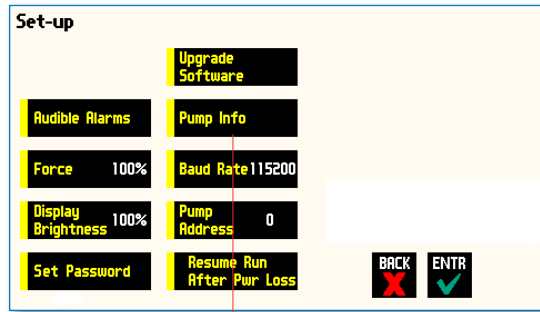

Press Here

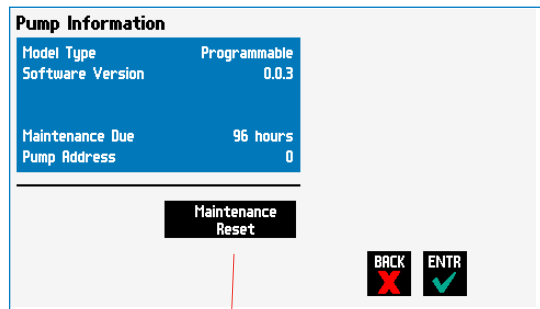

Press here to reset the maintenance counter

Operating the Pump

The Legato 100 Series is easy to operate because all the pump parameters are shown on the RUN Screen. Depending on the mode of the pump, different parameters will be shown on the display.

The Legato 100 Series Run Screen is shown below.

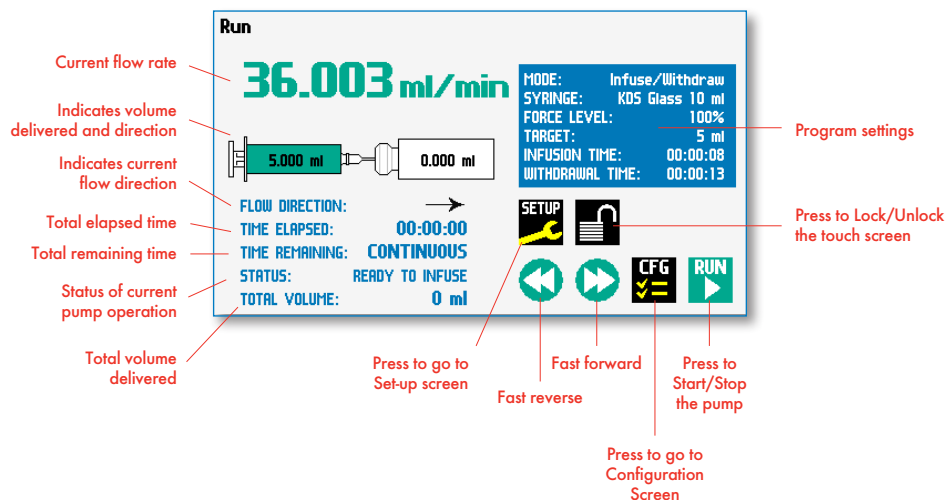



Running the Pump

Simply press the  button to start the pump.

When the pump is running the  button is shown.

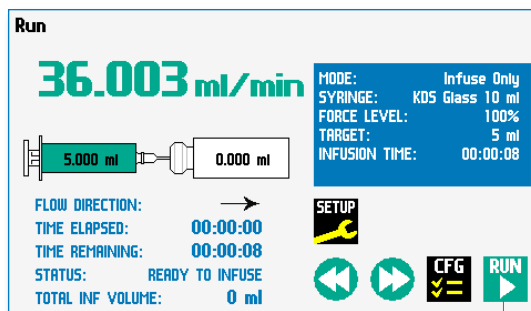
Press the  button to pause the program.



 **NOTE:** The fast forward and fast reverse keys are not active (grayed out) when the pump is running.

Custom Program Workflow (Legato 110, 111 & 180)

The following flow diagram describes the use of a Custom Program:

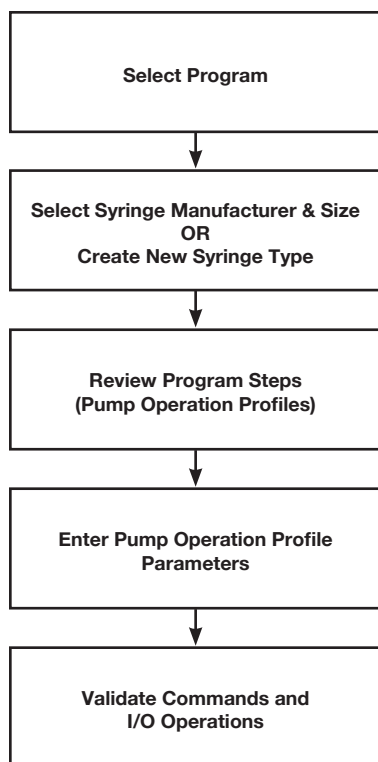

The software provides the user with a variety of prompts and warnings to help guide the setup of programs. For example, if a pump Program incorporates steps that exceed the capacity of the defined syringe, the system will prompt you that parameters are out-of-range. The system also prompts users if required values are not entered.



NOTE: The pump will check the validity of parameters entered for each Step in the Program, but will not review the Program in its entirety to verify that it is logical and can be fully executed

STEP-BY-STEP OPERATION EXAMPLE: USING A CUSTOM PROGRAM

The following steps describe operation using a Custom Program.

In the following description, we are assuming the use of a Program that is already saved on the KDS Legato 100 Series. Note that if you make any changes to the Program's operating parameters and choose Accept on the page where the changes are made, the changes automatically become part of the stored Program for future use.

1. From the Program Configuration screen, the Program you wish to use should be displayed in the Program Select button. If the Program is not displayed, select the correct Program using the procedure outlined in Running The Pump.
2. Choose the Syringe Select button to enter the Syringe Selection screen.
3. Follow the instructions in the Syringe Selection section of this Guide to complete the selection of a syringe from the built-in syringe definition list, or to create a new syringe definition. When finished, choose the Accept button to save your changes, or choose the Cancel button to cancel your changes, and return to the Program Configuration screen.
4. Review the Pump Control Profile Steps described in the Step Definition button. Note that the software will display the first three Steps in the Program in the main button area. If the Program uses more than three Steps, the last Step in the Program will be displayed in the box that is still part of the button beneath the Step Definition button.
5. To review the Program Steps in detail or to update/modify any of the stored Pump Control Profile Parameters, choose the Step Definition button to enter the Program Steps Summary Screen. The name of the Program is listed at the right of the screen, and the complete list of Steps is listed in a series of buttons is on the left of the screen.
6. To review details for any individual Step in the Program, select the Step you wish to review, then press the Step button again to enter the Step Definition screen for that Step.
7. To edit the parameters for any Pump Control Profile, follow the instructions supplied in the applicable Pump Operation Profile description contained in the Setting Program Parameters section later in this Guide.
8. To return to the Program Steps Summary screen when finished reviewing or editing the Step parameter details, choose the Accept button to save your changes or choose the Cancel button to cancel any changes you made.
9. When you are finished reviewing the operating details for all Steps, choose the Enter button to return to the Program Configuration screen.
10. To preview the Program, choose the Preview Program button, or to run the Program, choose the Program Run button.

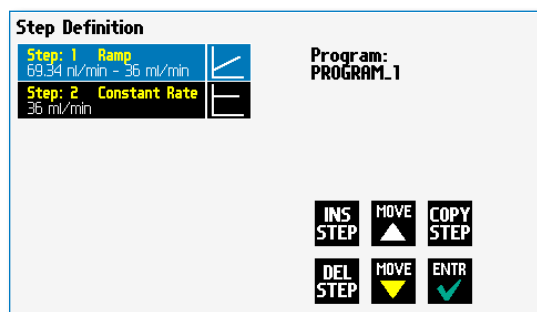

Step Definition Screen showing the list of Steps currently defined for the Program

Configuring Custom Programs

The Legato 100 Series Programmable Models offer the flexibility of configuring custom programs including multistep programs. The programs and steps can also be triggered to start and stop with events and external I/O, and user defined inputs. The maximum number of steps is 100 for all the programs.

To determine if your pump is programmable go to the pump information screen. The Model Type should say Programmable.



Press to see the pump information screen

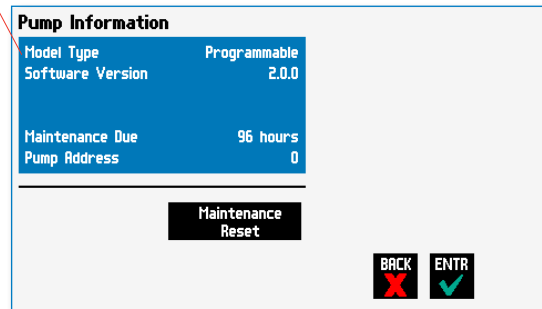
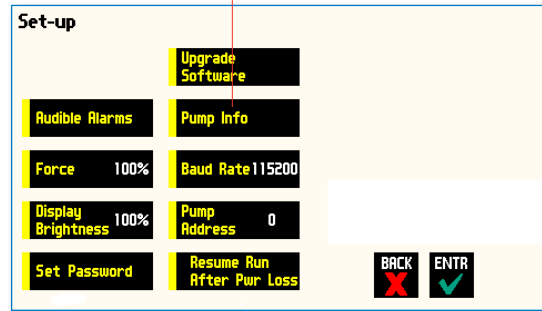

Configuring a New Custom Program

To display the **Mode Selection** screen press Mode.

Select Mode

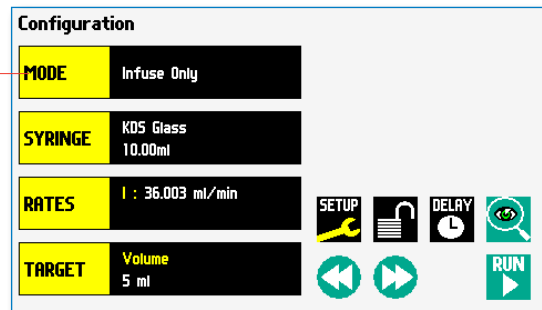



The Mode Selection screen will be displayed

Select **New Program**

View programs up a page 

View the programs down a page 

Views up the program 

Views down the program 

Press

Custom Program

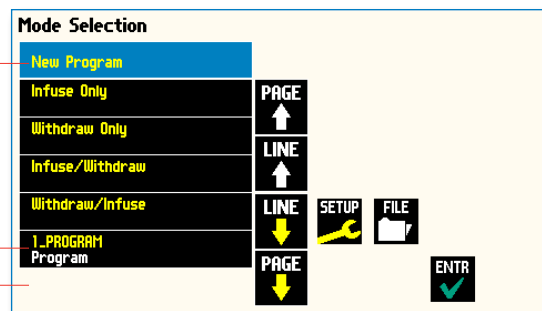

Configuring Custom Programs

The first thing to do on a custom program is to name the program.

Enter any 15 character alphanumeric name

Accept the new name 

Go back to the [Program Selection](#) screen 

Select the Syringe manufacturer and Size (see page 16)

To define the steps for the custom program press [Step Definition](#)

Below are some predefined steps including:

Constant Rate - a single continuous rate of flow

Ramped Rate - a linearly changing flow rate between a starting and ending flow rate

In addition to these you can repeat, in a program as well as send signals to external devices or react to signals received from external devices. This package of pumping profiles and commands provides users with an extremely broad array of applications that can be easily configured with complex external programming.

Programs can be edited and saved under a new name, allowing them to be simply edited to fit another application. Steps can be copied, moved, inserted or deleted.

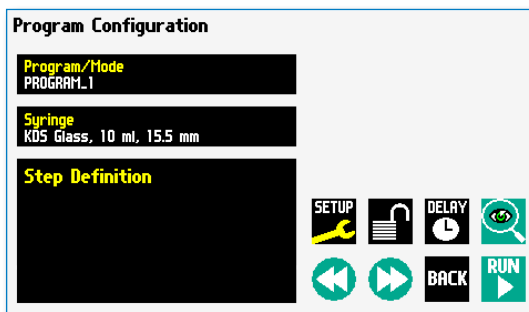

Setting A Delay

You can set the KDS Legato 100 Series to run after a delay. This delayed run function allows you to set up all the parameters for operation, then have the pump start unattended after a specified amount of time.

SETTING A DELAY FOR PROGRAM OPERATION:

1. From the Program Configuration screen, choose the Set Delay Parameters button to enter the Set Delay screen.
2. Enter the desired Time using the keypad.
3. If the Units of your Time are not correct for your application, select the Units button to toggle between sec (seconds) and hh:mm:ss (hours:minutes:seconds). To use the hh:mm:ss option, enter your time value in hours, minutes, and seconds, separating each value with a colon. You can enter a value up to 99:99:99.
3. When the desired values are entered, choose the Accept button to save your changes and return to the Program Configuration screen. When a Time Delay value is active, the Time Delay Parameters button is displayed in Red on the screen to alert the user that a delay has been set.
4. Press the Run button to activate the Delay.

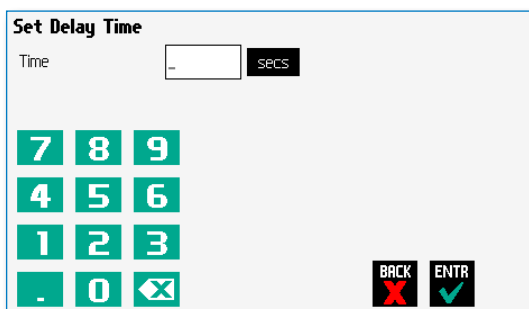
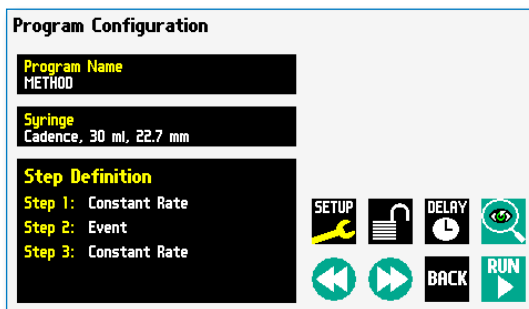
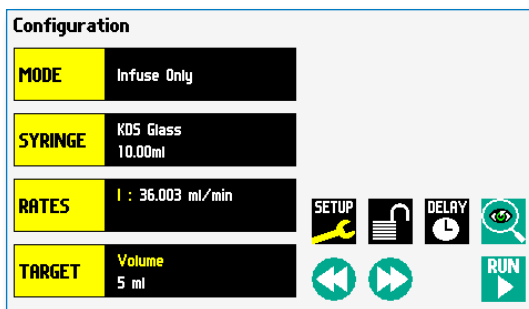

Set Delay Time screen

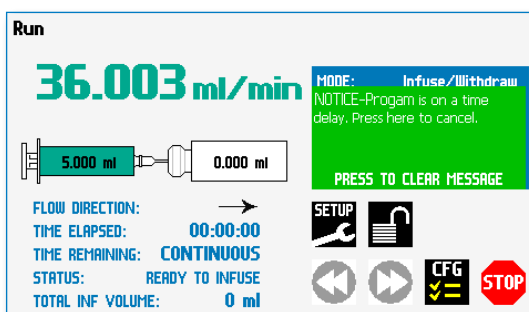

Quick Start run screen with a Time Delay Set

Creating a Custom New Program

If none of the Programs stored on the KDS Legato 100, 111 or 180 Series match your requirements, you can create a new Program and store the Program for use. The following flow diagram outlines the basic steps you will follow to create a new Program:

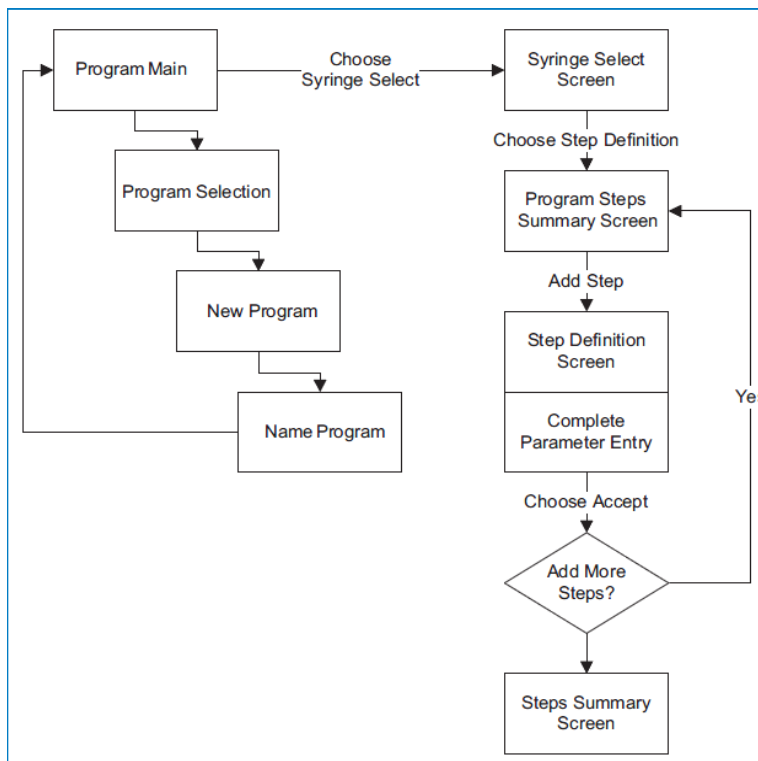

New User-Defined Program creation workflow

TO CREATE A NEW USER-DEFINED PROGRAM

1. From the Program Configuration or Programs screen, choose the Program Select button to enter the Program Selection screen.
2. Select New Program then choose Accept or press New Program again.
3. On the Program Name screen, type the name of your Program using the onscreen keyboard. Choose the Symbols/Numbers button **?123** to display the list of available numbers and symbols that can be included in the Program Name. To switch the keyboard back to letters mode, choose the Letters button (ABC).



New Program Name Entry screen showing letter keys. To view numbers/symbols, choose the **?123** use button in the lower left corner

TO CREATE A NEW USER-DEFINED PROGRAM (CONTINUED)

4. When you have entered the desired name for your Program, choose the Accept button to go to the Program Configuration screen. Your new Program will now be listed in the Program Select button.
5. Choose the Syringe Select button and complete the description of the syringe by following the procedure outlined previously in the Syringe Selection section of this Guide.
6. To begin creating Pump Control Profile Steps, choose the Step Definition button to enter the Program Steps Summary screen.
7. To add a Step to your Program, choose the Add Step button to access the Program Steps Menu screen. The available options include:

- | | |
|------------------|----------------------|
| a. Constant Rate | e. I/O (in) Event |
| b. Ramp | f. I/O (out) Trigger |
| c. Repeat | g. Stop |
| d. Delay | |

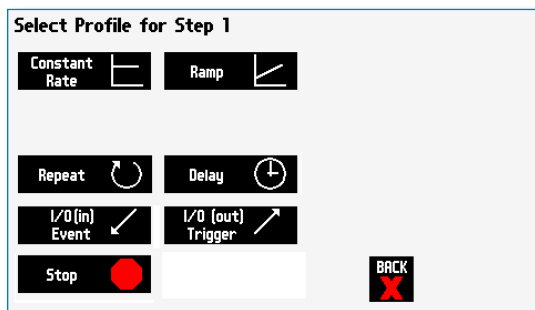

Program Steps Profile Menu screen

8. Choose the Program Step type that you want to add to the Program. If you choose a pumping profile (e.g. Constant Rate, Ramp, etc.) you will be taken to the Step Definition screen for the selected Program.
9. Complete the parameter entry applicable to the

selected Pump Operation Profile, follow the detailed instructions supplied in the Pump Operation Profiles (Existing and User-Defined Programs) section later in this Guide.

10. When you have completed all parameter entries on the Step Definition screen or completed the required entries for Advanced Options, choose the 'BACK' to save your changes and return to the Program Steps Summary screen.



11. Repeat items 7-10 in this procedure to include additional Steps in the Program.



NOTE: When adding a Step to a Program, the Step is added after the currently selected Step (i.e. the Step that is highlighted in blue)

12. When you are done adding all required Steps to the Program, choose the 'BACK' to return to the Program Main screen.



Modifying an Existing User-Defined Program

Once you have created a Program or have reviewed an Existing Program, you may have a need to modify the structure of the Program (i.e. the types of Steps and Commands included, not just changes in the operating parameters for a specific Step. The following procedures will help you to efficiently modify a stored Program.

CHANGING THE ORDER OF STEPS IN A PROGRAM

1. From the Program Configuration screen, choose the Step Definition button to enter the Program Steps Summary screen.

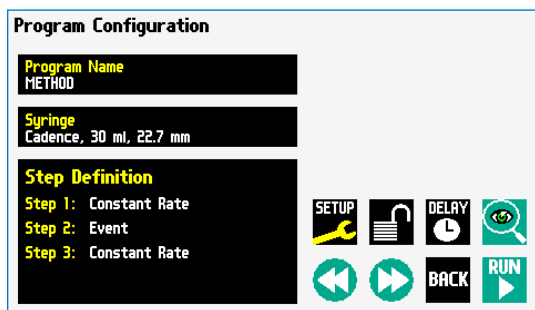

2. Highlight (select with a single touch) the Step for which you want to change the order.
3. Choose the Move Step Up or Move Step Down button, as required, to move the Step into the position that you want it executed.

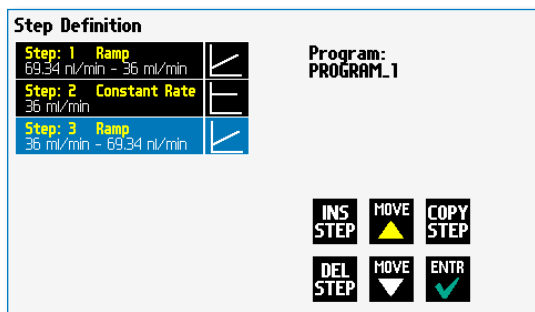

DELETING A STEP FROM A PROGRAM

1. From the Program Configuration screen, choose the Step Definition button to enter the Program Steps Summary screen.
2. Highlight (select with a single touch) the Step that you want to delete.
3. Choose the Delete Step button. The application will display a warning message in the Message Area asking you to confirm your deletion request.

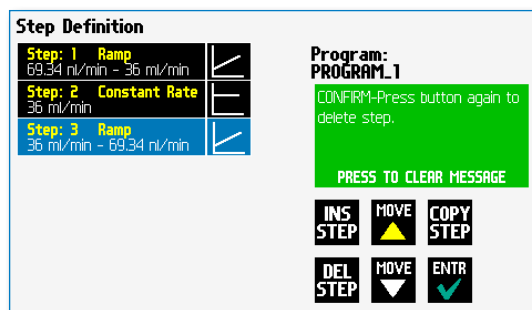

Delete Program Step showing confirmation message on the screen

4. To confirm the deletion, choose the Delete Step button again. The Step is removed and you are returned to the Program Steps Summary screen.

Defining Program Step Parameters

This section of the User Guide describes each of the available functions available for use in KDS Legato 100 Series Existing and User-Defined Programs. The information in this section is designed to help you set the individual parameter values in each of the Program Step options and to properly use the Advanced Options commands.

The information that follows is organized into two sections:

- Pump Operation Profiles
- Advanced Options (Commands and I/O)

PUMP OPERATION PROFILES

The KDS Legato 100 Series Existing Programs and all User-Defined Programs use Pump Operation Profiles as part of the Programs controlling the pump. These profiles are combined with a syringe selection and any Commands or Input/Output triggers to create a complete Program. The following sections describe each profile along with instructions for setting up the profile. The following Pump Operation Profiles are available on the KDS Legato 110, 111 or 180 pump:

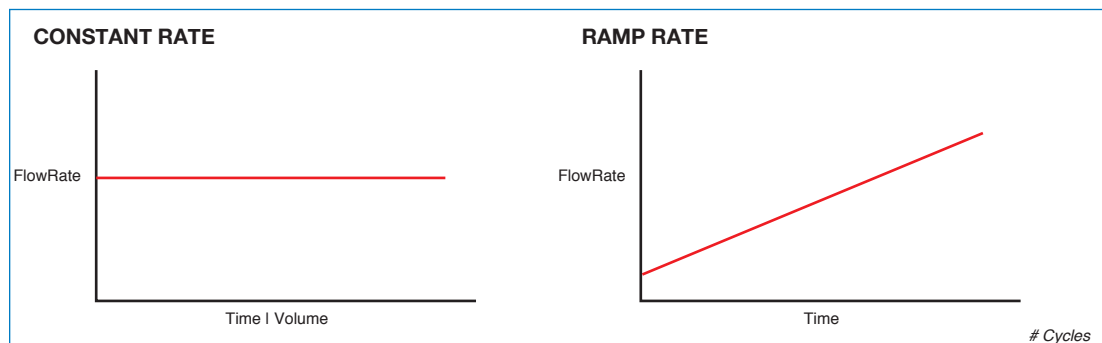

Pump Operation Profiles available on the KDS Legato 110, 111 or 180 pump.

Constant Rate Profile

The Constant Rate profile is used to run the pump at a defined flow rate and for a specific pumping mode (infuse or withdraw) up to a target volume or for a defined time period.

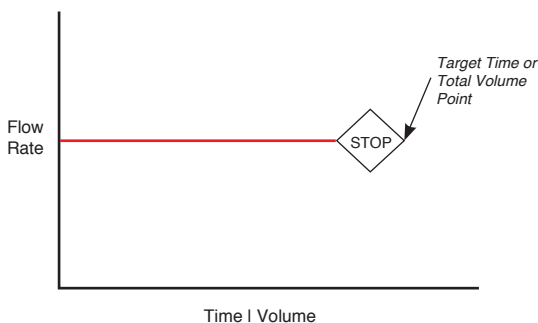

Constant Rate Pump Operation Profile

When creating or editing a Constant Rate profile, you will define three primary operating parameters:



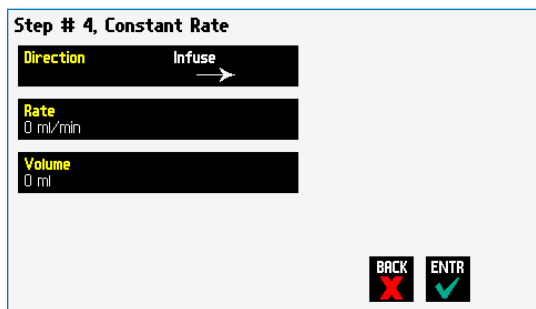

- The Flow Mode defining the direction of flow: infuse or withdraw
- The Flow Rate to define the rate of uptake or dispensing
- The Target Volume or Run Time that determine how long the pump will operate at the set rate

When creating or editing a Constant Rate profile, you can set the rate in ml, μ l, nl or pl units of volume using sec, min or hr as the units of time. The system automatically calculates a minimum and maximum flow rate based on the syringe selected or custom-defined. The min/max values are made available as button selection options on the Set Infuse and Withdraw Rate screens.



Constant Rate Profile Setup Screen

TO SET UP/EDIT A CONSTANT RATE PROFILE:

1. From the Step Definition screen for a Constant Rate profile, choose the **Direction** button to toggle the Flow Mode between Infuse and Withdraw operation.
2. Choose the **Rate** button to enter the Set Rate screen.
3. Enter the flow rate value desired using the keypad or select the **Minimum Rate** or **Maximum Rate** button.
4. If the Units of Rate are not correct for your application, choose the **Units** button.
5. On the Units Selection screen, select the unit of measure (ml, μ l, nl or pl) and the unit of time (sec, min, hr) as appropriate, then choose 'ENTR' to confirm your selections. 
6. When all parameters are correctly set on the Set Rate screen, choose 'ENTR' from your settings and return to Constant Rate Definition screen. 
7. Choose the **Volume** button to enter the Set Volume or Time screen.
8. On the Set Volume or Time screen, select the **Volume or Time** button, as desired.
9. Enter the desired value using the keypad, or select the **Maximum Volume** button.
10. If the Units of Volume/Time are not correct for your application, choose the **Units** button to the right of the parameter entry box. For the Units of Volume, this choice takes you to the Units Selection screen. For the Units of Time option, this choice will toggle the button between sec (seconds) and h:m:s (hours:minutes:seconds). To use the h:m:s option, enter your time value in hours, minutes and seconds, separating each value with a colon.
11. If you are changing the Units of Volume, on the Units Selection screen, select the unit of measure (ml, μ l, nl or pl) as appropriate, then choose 'ENTR' from your selection. 
12. When all parameters are correctly set on the Set Target Volume or Time screen, choose 'ENTR' to confirm your settings and return to the Constant Rate Definition screen. 
13. Choose 'ENTR' to return to the Step Definition screen. 

Ramp Profile

The Ramp Rate profile is used to create a linearly increasing or decreasing flow rate for a single pumping mode (infuse or withdraw) over the course of a defined time period.

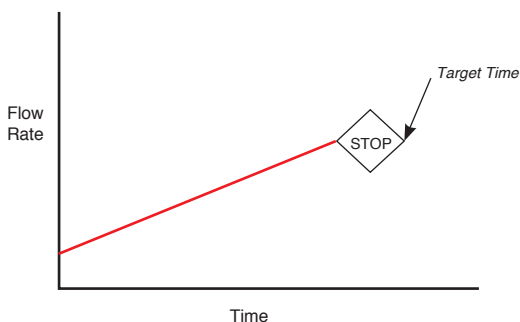

Ramp Rate Pump Operation Profile

When creating or editing a Ramp Rate profile, you will define three primary operating parameters:

- The Flow Mode defining the direction of flow: infuse or withdraw
- The Flow Rate at the beginning and end of the pumping cycle
- The Target Time that determines the total length of time over which the ramp will be calculated

During a Ramp Rate profile, the KDS Legato 100 Series varies the flow rate linearly between the starting rate and ending rate over the full time period entered. A Ramp Rate profile can be applied to an increasing or decreasing rate application.

When creating or editing a Ramp Rate profile, you can set the rate in ml, μ l, nl or pl units of volume using sec or h:m:s (hours:minutes:seconds) as the units of time. The system automatically calculates a minimum and maximum flow rate based on the syringe selected or custom-defined. The min/max values are made available as button selection options on the Set Infuse and Withdraw Rate screens.

TO SET UP/EDIT A RAMP RATE PROFILE:

1. From the Step Definition screen for a Ramp Rate profile, choose the Direction button to toggle the Flow Mode between Infuse and Withdraw operation.

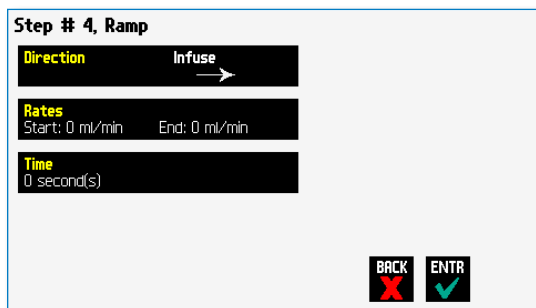

2. Choose the Set Start & End Rate button to enter the Set Start & End Rates screen.

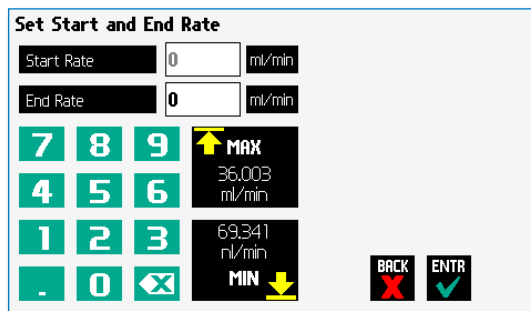

Set Start and End Rates screen

3. Select the Start Rate button (it should be selected by default as indicated by the active data entry box to the right of the button). Enter the flow rate value desired using the keypad or select the Minimum Rate or Maximum Rate button.
4. If the Units of Rate are not correct for your application, choose the Units button.
5. On the Units Selection screen, select the unit of measure (ml, μ l, nl or pl) and the unit of time (sec, min, hr) as appropriate, then choose 'ENTR' to confirm your selections.
6. Repeat Steps 3 to 5 for the End Rate by selecting the End Rate button and continuing data entry.
7. When all parameters are correctly set on the Set Rate screen, choose 'ENTR' to confirm your settings and return to Ramp Definition screen.
8. Choose the Time button to enter the Set Time screen.
9. Enter the desired Time value using the keypad.
10. If the Units of Time are not correct for your application, select the Units button to toggle between sec (seconds) and h:m:s (hours:minutes:seconds). To use the h:m:s option, enter your time value in hours, minutes and seconds, separating each value with a colon.
11. When all parameters are correctly set on the Set Target Time screen, choose Accept to confirm your settings and return to the Ramp Definition screen.
12. Choose Accept again to return to the Step Definition screen.



NOTE: Ramps \leq 2 seconds from min to max rates may cause motor stalls.



Delay

The Delay Command is used to insert a time delay in a procedure. You can program a time delay between 0.2 seconds up to 99:99:99 (99 hours, 99 minutes, 99 seconds).

TO INSERT A TIME DELAY IN A PROGRAM:

1. From the Program Main screen, choose Step Definition to enter the Step Definition screen.
2. Highlight (select once) the Program Step that you want the time delay to follow.
3. Choose the Insert Step button to access the Program Steps Menu screen.
4. Choose Advanced Options to enter the Set Advanced Options screen.
5. Choose Delay to enter the Set Delay Time screen.

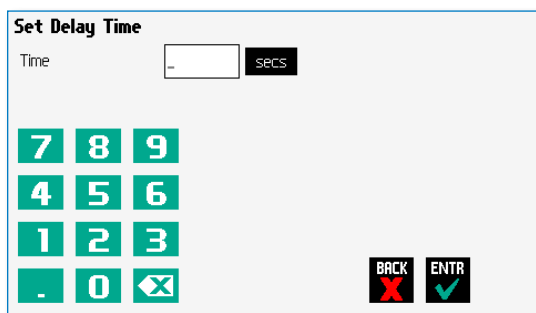

Advanced Options Set Delay Time screen

6. Enter the desired Time using the keypad.
7. If the Units of Time associated with Time are not correct for your application, select the Units button to toggle between sec (seconds) [0.2 seconds minimum allowable value] and h:m:s (hours:minutes:seconds). To use the h:m:s option, enter your time value in hours, minutes and seconds, separating each value with a colon. You can enter a value up to 99:99:99.
8. When your Time entry is correct, choose the Accept button to insert the Delay Step in the Program and return to the Step Definition screen.

Repeat Step



NOTE: Do not use nested loops (repeat within a repeat)

The Repeat Command is used to repeat Steps in a procedure a defined number of times. To use this Command, you will tell the application what Steps you want to Repeat and how many times you want them repeated. The Repeat Step command creates a "jump" back to a specific Step in a Program that executes the defined Step plus all following Steps up to the Repeat command (i.e. it creates a Program loop).

When defining a Repeat jump in a Program, the Command targets the Step sequence position and not the function that currently occupies that position. For example, if you create a Repeat jump to Step 4 in a Program (currently a Ramp Pump Operation Profile) and subsequently move a Constant Rate profile into the Step 4 position, the Repeat jump will then connect to the Constant Rate operation and not to the Ramp operation.

TO INSERT A STEP REPEAT SEQUENCE IN A PROGRAM:

1. From the Program Main screen, choose Step Definition to enter the Step Definition screen.
2. Highlight (select once) the Program Step that you want the repeat step to follow.
3. Choose the 'INS STEP' button to access the Program Steps Menu screen.
4. Choose Advanced Options to enter the Set Advanced Options screen.
5. Choose Repeat to insert the Repeat Step function into the Program.
6. Select the Step(s) you would like to repeat from by selecting the Step button twice or selecting once and then choosing Accept.

INS STEP

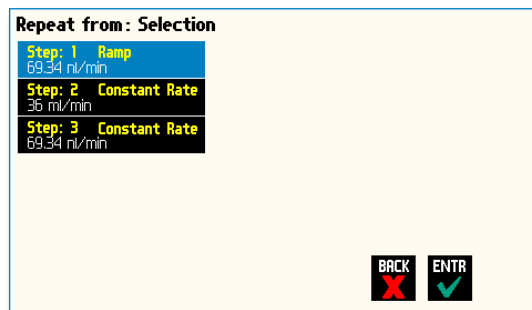

Advanced Options Repeat Step screen. Choosing Repeat brings you to a listing of the available steps in the Program

7. Enter the number of repeats using the keypad then choose the Accept button to save your change and return to the Step Definition screen.



NOTE: This command creates a loopback to the designated Step in a Program, executing the selected Step, plus all subsequent Steps up to the point of insertion of the Repeat command. For example, if the Repeat command is set to repeat Step 2 one time, the system will loop back to Step 2 and execute both Steps 2 and 3 one additional time.

Stop

The Stop Command is used to instruct the pump to stop operation. This Command can be used in conjunction with I/O Events to control pump operation based on external events.

TO INSERT A STOP COMMAND IN A PROGRAM:

1. From the Program Main screen, choose Step Definition to enter the Step Definition screen.
2. Highlight (select once) the Program Step that you want the Stop Command to follow.
3. Choose the **INS STEP** button to access the Program Steps Menu screen.
4. Choose Advanced Options to enter the Set Advanced Options screen.
5. Choose Stop to insert the Stop Command into the Program.

A small, square button with a yellow background and black text that reads "INS STEP".

I/O EVENT TRIGGERS

The KDS Legato 110, 111 and 180 pumps permits easy connection to external I/O devices via a variety of interfaces, including a built-in 15-pin D-sub connector. The KDS Legato 110, 111 and 180 Series software incorporates simple commands for incorporating I/O controls into your pump Programs. Integrated commands for control of general trigger signals are integrated in the software. The following procedure describes the use of the Advanced Options I/O commands. Following the procedure is a description of the selection menu options for each of the I/O command types. Details for the electrical connection controls and pin-out description for the 15-pin User I/O Connector are provided in Appendix C of this manual.

The KDS Legato 110, 111 and 180 manages trigger events through specific pins on the I/O Connector port on the back of the pump. The following details define pin logic:

- Trigger is communicated via Pin 4.
- Event signals are communicated via Pin 2.

I/O (OUT) Trigger

The I/O (OUT) Trigger command is used to send a signal to an external device when the Step in the Program is reached.

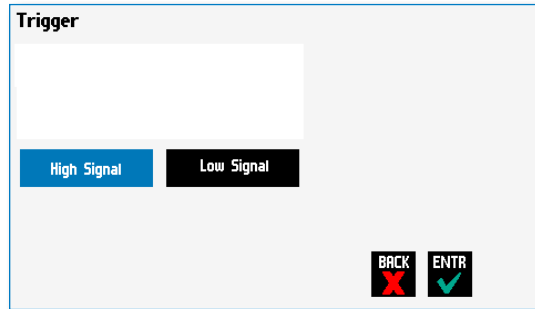

I/O (OUT) Trigger Advanced Options menu

The following options are available when setting an I/O (OUT) Trigger command:

- **Trigger 1:** Specifies output via the Trigger 1 (Pin 4) port. When selected, you must also specify whether the signal to be sent is High Signal or Low Signal.
 - **High Signal:** Sets the output signal to logic high.
 - **Low Signal:** Sets the output signal to logic low.

TO INSERT AN I/O (OUT) TRIGGER COMMAND:

1. From the Program Main screen, choose Step Definition to enter the Step Definition screen.
2. Highlight (select once) the Program Step that you want the I/O (OUT) Trigger to follow.
3. Choose the **INS STEP** to access the Program Steps Menu screen.
4. Choose **Advanced Options** to enter the Select Advanced Options screen.
5. Choose the **I/O (OUT) Trigger** button to enter the Trigger Step Definition Screen.
6. Set your Trigger settings by using the following procedure:
 - a. To send a Trigger signal to an external device via Pin 4 select whether the signal will be High or Low by selecting the appropriate button (selection will highlight in white).
7. Choose the Accept button to save your changes and return to the Step Definition screen.

**INS
STEP**



NOTE: When using triggers, the first step in your program should define the trigger starting level (High or Low). You may then use the trigger command to change the level as desired for your Program.

I/O (IN) Event

The I/O (IN) Event command is used to have the pump pause and wait for a signal from an external device or for a manual user input at the touchscreen. These external signals are communicated via Pin 2 on the 15-pin I/O Connector port.

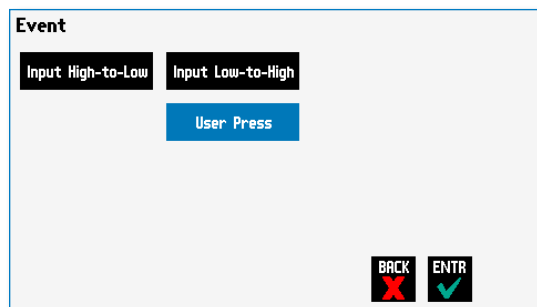

I/O (IN) Event Advanced Options menu

The following options are available when setting an I/O (IN) Event command.

- **Input High-to-Low:** Sets the pump to wait for a logic low input signal falling edge.
- **Input Low-to-High:** Sets the pump to wait for a logic high input signal rising edge.
- **User Press:** Sets the pump to wait for manual input from the user at the touchscreen (screen touch).

TO INSERT AN I/O (IN) EVENT COMMAND:

1. From the Program Main screen, choose Step Definition to enter the Step Definition screen.
2. Highlight (select once) the Program Step that you want the I/O (IN) Event to follow.
3. Choose the 'INS STEP' to access the Program Steps Menu screen.
4. Choose **Advanced Options** to enter the Select Advanced Options screen.
5. Choose the **I/O (IN) Event** button to enter the Event Step Definition Screen.
6. Select either Input High, Input Low or User Press, as appropriate.
7. Choose the Accept button to save your changes and return to the Step Definition screen.

INS
STEP

MANAGING LEGATO 100 SERIES PROGRAMS

All Existing and User-Defined Programs are stored in the Program List for ongoing use. Over time, you may want to manage previously created Programs to keep your Program List easy to navigate. In addition, the KDS Legato 110, 111 and 180 pumps allows you to export Program information to an externally connected pump or to a computer that will be used to control operation. This section of the Guide describes the file management facilities available on the KDS Legato 110, 111 and 180.



NOTE: The program management procedures outlined in this section are not available for non-programmable programs.



NOTE: The program management procedures outlined in this section are not available for basic pump models (Infuse Only, Withdraw/Infuse, etc.).

Saving A Copy Of A Program

Follow these instructions to save a copy of a Program under a new name:

1. From Program Configuration screen, choose the Program Name button to enter the Mode Selection screen.
2. From the list of available Programs, select (press once) the Program you want to save a copy of, then choose the File Options button to enter the File Options screen.
3. Choose **Save As/Copy** to access the Program Name Entry screen. The current Program Name will be displayed in the text entry box.
4. On the Program Name screen, type the new name for your Program using the onscreen keyboard. Choose the Symbols/Numbers button **‘.?!123’** to display the list of available numbers and symbols that can be included in the Program Name. To switch the keyboard back to letters mode, choose the Letters button **‘ABC’**. [15 characters maximum]
5. When finished entering the new Program Name, choose Accept to save your changes and return to the File Options screen.
6. Choose **‘BACK’** to return to the Mode Selection screen.



Renaming A Program

Follow these instructions to rename a previously saved Program:

1. From the Program Configuration screen, choose the Program Name button to enter the Program Mode screen.
2. From the list of available Programs, select (press once) the Program you want to rename, then choose the File Options button to enter the File Options screen.
3. Choose **Rename Program** to access the Program Name Entry screen. The current Program Name will be displayed in the text entry box.
4. On the Program Name screen, type the new name for your Program using the onscreen keyboard. Choose the Symbols/Numbers button **‘.?!123’** to display the list of available numbers and symbols that can be included in the Program Name. To switch the keyboard back to letters mode, choose the Letters button **‘ABC’**. [15 characters maximum]
5. When finished entering the new Program Name, choose Accept to save your changes and return to the File Options screen.
6. Choose **‘BACK’** to return to the Program Selection screen.



Appending A Program

Follow these instructions to Append a previously created Program into a new Program:

1. From the Program Configuration screen, choose the Program Name button to enter the Mode Selection screen.
2. From the list of available Programs, select (press once) the Program you want as the base Program.
3. Choose the **File Options** button to enter the File Options screen.
4. Choose **Append** to access the Program to Append screen.
5. Choose (press twice) the Program you would like to Append (attach) to your base Program. The pump will return you to the File Options screen and display a confirmation that the Program was copied.
6. Choose **"BACK"** to return to the Mode Selection screen.



Deleting A Program

Follow these instructions to delete a previously saved Program:

1. From the Program Configuration screen, choose the Program Name button to enter the Mode Selection screen.
2. From the list of available Programs, select (press once) the Program you want to delete, then choose the File Options button to enter the File Options screen.
3. Choose **Delete Program**. The application will display a warning message in the Message Area asking you to confirm your deletion request.
4. Choose **Delete Program** again to confirm the deletion and return to the Mode Selection screen.

LEGATO 100 SERIES PROGRAM EXPORT AND IMPORT

The Legato 100 Series pump permits the daisy chaining of multiple pumps, as well as integration with/control by an external computer through HyperTerminal. To facilitate operation in these modes, the Legato 100 Series application software includes a variety of commands designed to simplify the export/import of Programs between the pump and external devices. This section outlines the use of these commands.



NOTE: Do not attempt to Export/Import Programs while the pump is running.



NOTE: Do not change screens while Importing/Exporting a program.



NOTE: For additional details on the physical interfaces used to connect the KDS Legato 100 Series to external devices, refer to the External I/O Connections section in the Appendices.

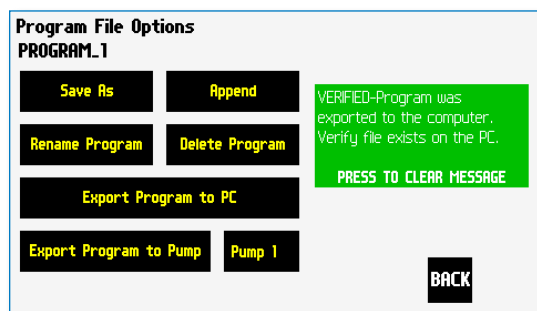

Export Program confirmation screen showing successful export

TRANSFER A PROGRAM BETWEEN PUMPS



NOTE:

- If both pumps have software versions 2.0.0 or higher, programs can be transferred via RS-485
- If both pumps have software versions 1.0.4 or lower, programs can be transferred via RS-485
- If one pump has software version 1.0.4 or lower and the other pump has 2.0.0 or higher, programs must first be uploaded to the PC, and then downloaded to the desired pump using Syringe Pump Communicator program

Follow these instructions to transfer a Program between two KDS Legato 100 Series pumps.

1. Connect two pumps together via an RS-485 (firewire type) cable and set the address on the first pump to '00' using the Set Pump Address command in the Settings menu.
2. Set the address on the second pump to something other than '00' using the Set Pump Address command in the Settings menu.
3. From the Program Main screen, choose Program Select then choose the Program you would like to export.
4. Choose the [File Options](#) button.
5. Choose the Pump button and enter the address for the pump you would like to receive the Program.
6. Choose Export Program to Pump.
7. The pump will display a confirmation message in the Message Area on the screen when the export is complete. Note that long Programs may take a few seconds to export.
8. Before disconnecting the pumps, verify that the Program was successfully exported by choosing Program Select from the Program Main screen on the destination pump, then browse the available Programs to verify that the exported Program is shown in the menu.

Exporting A Program To An External Computer

Follow these instructions to export a Program to an external computer.

1. Connect the pump to the external computer via a USB cable.
2. On the computer, open the HyperTerminal application and verify that the computer can communicate with the pump.
3. At the pump, from the Program Main screen, choose Program Select then choose the Program you would like to export.
4. Choose the **'FILE OPTIONS'** button.
5. In HyperTerminal, choose Transfer→Capture Text...
6. Enter the File Name that you want to save the Program under, then choose Start.
7. Choose Export Program to PC.
8. The pump will display a confirmation message in the Message Area on the screen when the export is complete. Note that long Programs may take a few seconds to export.
9. At the destination computer, in HyperTerminal, when the Program is done transferring, the message "mend" will appear onscreen.
10. In HyperTerminal, choose Transfer→Capture Text...→Stop. Your Program is now saved on the external computer.



IMPORTING A PROGRAM FROM AN EXTERNAL COMPUTER

Follow these instructions to import a Program from an external computer.

1. Connect the pump to the external computer via a USB cable and set the Address value to '00' using the Set Pump Address command in the Settings menu.
2. On the computer, open the HyperTerminal application and verify that the computer can communicate with the pump.
3. In HyperTerminal, click on the Properties icons and choose the Settings tab on the pop-up box that is displayed.
4. Click on the ASCII Setup button.
5. In the Line Delay field, enter 500. This will set a 500 millisecond delay after each line is transferred during the import process.
6. Click OK twice to return to the HyperTerminal Main Menu screen.
7. In HyperTerminal, choose Transfer→Send Text File...
8. Select the Program that you want to import to the pump and click Open.
9. Before disconnecting, verify that the Program was transferred by choosing Program Select from the Program Main screen at the destination pump, then browse the Program menu to confirm that the new Program is now saved at the pump.



NOTE: The KD Scientific Syringe Pump Communicator program, provided on the Legato CD, can be used to simplify the import / export process for programmable pumps. Please refer to the Syringe Pump Communicator manual for instructions.



EXTERNAL PUMP CONTROL

This section of the KDS Legato 100 Series manual describes the control of the pump using an external computer device. If communicating via the USB Port, see Appendix C for one time installation instructions of USB Driver.

NOTE: The KD Scientific Pump Terminal Program, provided on the Legato CD, can be used for easy external control of the Syringe Pump via RS-232 or USB connection.

Setting Up HyperTerminal

HyperTerminal is a Windows application designed to support the external control of devices such as the KDS Legato 100 Series pump through a USB connection. The following instructions describe the configuration of the HyperTerminal application.

1. Select "Start - All Programs - Accessories - Communications - HyperTerminal".
2. Enter a name for a New Connection (i.e KDS_Legato_100), then click OK.



3. Select the Virtual Comm Port from the "Connect using" drop-down list. Click OK. (If the Virtual Comm Port is not known, use Device Manager to find it. Instructions on setting up the Virtual CommPort Driver are supplied in Appendix C.)



NOTE: To determine the proper comport, in your PCs "Systems Properties" screen, under the "Hardware" tab, select "Device Manger". Expand the "ports (COM & LPT)" section and you should see "Syringe Pump". The comport is listed next to this in parenthesis.

4. Set up the Port Settings as shown below and click OK.

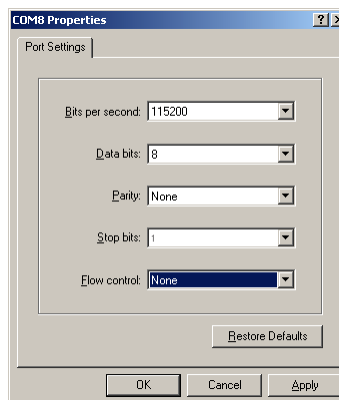

5. Verify the Settings are as shown below.

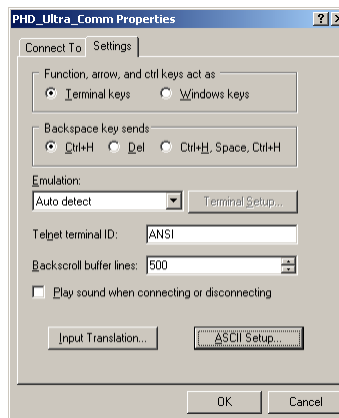

6. Choose ASCII Setup and select "Echo typed characters locally" then click OK to complete the setup.

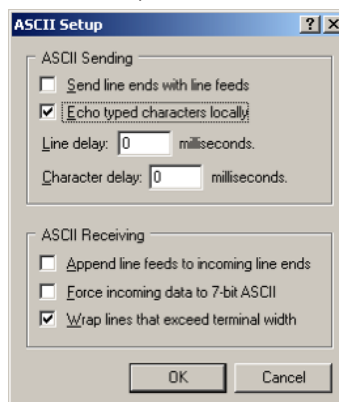

NOTE: To determine if your pump is connected correctly, in Hyperterminal's main window press 'Enter'; a ':' should appear. If not connected properly, close Hyperterminal, turn off the pump, unplug then re-plug the USB cable and re-open Hyperterminal.

PUMP CHAIN COMMANDS

The Pump Chain commands allow all pump control information to be managed from an external computer source. These commands can also be used to control a series of pumps (up to 100) from a single computer interface.

KDS Legato 100 Series commands are communicated to the pump via the USB port interfaces through a terminal program such as HyperTerminal. In using the Pump Chain commands, you will need to assign each pump in the pump chain a unique address, using the Set Pump Address command in the Settings menu. The address range is from 00 to 99. This address value is used to identify which pump is to receive a command and which pump is responding. The first pump in the chain, the one connected to the computer, must use address 0 (zero). Configure each pump with its assigned address and baud rate as described in the Pump Settings section of this guide.



NOTE: Once communication is established, if you manipulate the touchscreen, you must reestablish communications to the PC (<CR> will do this)



NOTE: System commands and start/stop commands can be executed from program or mode configuration screens. For parameter commands (rate, dia, vol, etc) it is necessary to execute from the Configuration Run screen.



NOTE: To maximize communication speed [as fast as 50 ms rate changes]: (a) prefix commands with the @ symbol to turn off GUI updates (ex: @irate 100 u/m) (b) use the 'NVRAM off' command to turn off writes of rate to memory.

Pump Chain Commands

KDS Legato 100 commands are entered via the USB port with a terminal program such as HyperTerm, or by using a controlling computer.

Commands may be abbreviated to the first four letters, i.e. address would be abbreviated addr. A space must follow the command if arguments are included.

Every line of the response from a pump with a nonzero address is prefixed by the two digit pump address (prefixed with a 0 if necessary) followed by a colon. No colon is used to separate the pump address from the prompt however.

In the command list below, the following convention is used:

{ }	Required parameter
[]	Optional parameter
	Separator between parameter choices
#	Numeric value without preceding zeros
###	Numeric value with preceding zeros
#.#	A range of values
<cr>	Carriage return
<lf>	Line feed
<sp>	Space
[prefix]	Pump address prefix in the format #: if the pump address is not zero
<prompt>	Prompt (see below)

The following prompts are returned after a command is executed:

:	The pump is idle
>	The pump is infusing
<	The pump is withdrawing
*	The pump stalled
T*	The target was reached

If the pump is in poll mode, an XON character is added after the prompt.

If the pump address is nonzero, the pump address is prefixed to the prompt without a colon.

In the following list of commands:

The pump address is prefixed to every response line followed by a colon.

<lf>[##]<prompt> is the response unless otherwise noted.

Error messages

Error messages are displayed if the entered command cannot be executed for some reason. The error message will take up two lines with the first line being the message type and the second line describing the error itself. The second line may be up to 80 characters long.

Command errors

Command errors are displayed when the command is unrecognized, entered in the wrong mode, or the state of the pump keeps the command from executing (i.e. using the IRUN command if a limit switch is active).

The command error has the following format:

```
<lf>[##:]Command error:<cr>
<lf>[##:]<sp><sp><sp>{error message}<cr>
<lf>[##]<prompt>
```

Argument errors

Argument errors are displayed when a command argument is unrecognized or out of range. The argument in question will be displayed except in the case of missing arguments.

The argument error has the following format:

```
<lf>[##:]Argument error: [bad argument]<cr>
<lf>[##:]<sp><sp><sp>{error message}<cr>
<lf>[##:]<prompt>
```

System commands

ADDRESS

Sets or displays the pump address. Valid range is 0 to 99.

Command format:

```
address [0-99]
```

Query response:

```
<lf>[##:]Pump address is #<cr>
<lf>[##:]<prompt>
```



NOTE: Pumps with an address of 0 are masters, and pumps with an address between 1 and 99 are slaves.

CATALOG

Displays a catalog of programs stored in the pump.

Command format:

```
cat
```

Query response:

```
<lf>[##:]Program name    Size<cr>
<lf>[##:]————— —<cr>
<lf>[##:]{program name}  #<cr>
This line is repeated for each file on the disk
<lf><lf>[##:]# file(s) using # steps<cr>
<lf>[##:]<prompt>
```



NOTE: The file size is the number of steps in the program plus one for the file information header.

The last line shows the number of files and the total number of steps being used on the disk.

CONFIG

Sets or displays pump configuration.

Command format:

```
Config [{config designation}] {value}
```



NOTE: After changing the configuration, the pump must be power cycled.

DELMETHOD

Deletes a program, stored in the pump.

Command format:

```
delmethod {program}
```

DIM

Sets or displays the brightness level in percent. Valid range is 0 to 100. Note that specifying 0 will turn the backlight off so that the screen will not be visible.

Command format:

```
dim [0-100]
```

Query response:

```
<lf>[##:] #%<cr>
<lf>[##:]<prompt>
```

ECHO

Sets or displays the USB echo state. Valid states are on or off.

Command format:

```
echo [on | off]
```

Query response:

```
<lf>[##:] OFF<cr>
<lf>[##:]<prompt>
```

or:

```
<lf>[##:] ON<cr>
<lf>[##:]<prompt>
```

FORCE

Sets or displays the infusion force level in percent. Valid range is 1 to 100.

Command format:

```
force [1-100]
```

Query response:

```
<lf>[##:]#%<cr>
<lf>[##:]<prompt>
```

LOAD

Loads a method or displays the currently loaded method.

Command format:

```
load
load {method name}
load qs {i | w | iw | wi}
```

Query response:

```
<lf>[##:]Quick Start - Infuse Only (qs i)<cr>
<lf>[##]<prompt>
```

or:

```
<lf>[##:]Quick Start - Withdraw Only (qs w)<cr>
<lf>[##]<prompt>
```

or:

```
<lf>[##:]Quick Start - Infuse/Withdraw (qs iw)<cr>
<lf>[##]<prompt>
```

or:

```
<lf>[##:]Quick Start - Withdraw/Infuse (qs wi)<cr>
<lf>[##]<prompt>
```

or:

```
<lf>[##:]{method name}<cr>
<lf>[##]<prompt>
```

FTSWITCH

Sets or displays the footswitch setting. The footswitch may be used in a toggle on or off mode (momentary), a press to run mode (falling), or a release to run mode (rising).

Command format:

```
ftswitch [mom | rise | fall]
```

Query response:

```
<lf>[##:]Momentary<cr>
<lf>[##]<prompt>
```

or:

```
<lf>[##:]Active high<cr>
<lf>[##]<prompt>
```

or:

```
<lf>[##:]Active low<cr>
<lf>[##]<prompt>
```

POLL

Sets or displays the polling mode state. In polling mode, prompts are inhibited if they aren't generated by a typed command. Valid states are on or off.

Command format:

```
poll [on | off]
```

Query response:

```
<lf>[##:]OFF<cr>
<lf>[##]<prompt>
```

or:

```
<lf>[##:]ON<cr>
<lf>[##]<prompt>
```

TILT

Calibrates tilt sensor.

Command format:

```
tilt
```

Query response:

```
<lf>[##:]Calibrating the tilt sensor...<cr>
<lf>[##:]Tilt calibration value is #<cr>
<lf>[##]<prompt>
```

SYRMANU

Sets or displays the syringe manufacturer. Configuration Run screen mode only. Valid 3-character manufacturer codes are shown in the table below:

air	Air-Tite, HSW Norm-Ject
bdg	Becton Dickinson, Glass (all types)
bdp	Becton Dickinson, Plasti-pak
cad	Cadence Science, Micro-Mate Glass
hm1	Hamilton 700, Glass
hm2	Hamilton 1000, Glass
hm3	Hamilton 1700, Glass
hm4	Hamilton 7000, Glass
hos	Hoshi
kgl	KD Scientific, Glass
ils	ILS, Glass
nip	Nipro
sge	SGE (Scientific Glass Engineering)
smp	Sherwood-Monoject, Plastic
sst	Stainless Steel
tej	Terumo Japan, Plastic
top	Top

Typing 'symr' with no arguments displays the current syringe setting.

Typing 'symr ?' displays a list of manufacturers with their associated 3-letter code.

Typing 'symr {code} ?' shows a list of syringe sizes associated with the specified manufacturer.

Command format:

```
syrm [?|{3 char code}?|{volume}ul|ml]
```

Query response:

```
<lf>[##:]{manufacturer}, {diameter} mm<cr>
```

```
<lf>[##]<prompt>
```

or:

```
<lf>[##:]Custom, {diameter} mm<cr>
```

```
<lf>[##]<prompt>
```

or:

```
<lf>[##:]{code}, {diameter} mm<cr> (this line is repeated for each syringe manufacturer)
```

```
<lf>[##]<prompt>
```

or:

```
<lf>[##:]{volume}, {unit}<cr> (this line is repeated for each syringe size)
```

```
<lf>[##]<prompt>
```

VER

Displays the short version string.

Command format:

```
ver
```

Query response:

```
<lf>[##:]KDS Legato 1XX #.#.#<cr>
```

```
<lf>[##]<prompt>
```

VERSION

Displays the full version string.

Command format:

```
version
```

Query response:

```
<lf>[##:]Firmware: v#.#.#<cr>
```

```
<lf>[##:]Pump address: #<cr>
```

```
<lf>[##:]Serial number: C #####<cr>
```

```
<lf>[##:]Device ID: #####<cr>
```

```
<lf>[##]<prompt>
```

Run commands

IRUN

Runs the pump in the infuse direction. Configuration Run screen mode only.

Command format:

```
irun
```

RRUN

Runs the pump in the opposite direction. Configuration Run screen only.

Command format:

```
rrun
```

RUN

Simulates a key press of the run button located in the lower right corner of the screen.

Command format:

```
run
```

STOP / STP

Stops the pump.

Command formats:

```
stop
```

```
stp
```

WRUN

Runs the pump in the withdraw direction. Configuration Run screen mode only.

Command format:

```
wrun
```

Rate commands

CRATE

Displays the current rate that the motor is running at. A valid response is returned only in dynamic situations (if the motor is running). Configuration Run screen mode only.

Command format:

```
crate
```

Query response:

```
<lf>[##:]Infusing at # xl/xxx<cr>
```

```
<lf>[##]<prompt>
```

or:

```
<lf>[##:]Withdrawing at # xl/xxx<cr>
```

```
<lf>[##]<prompt>
```

DIAMETER

Sets or displays the syringe diameter in mm. Configuration Run screen mode only.

Command format:

```
diameter [{syringe diameter}]
```

Query response:

```
<lf>[##:]#.##### mm<cr>
```

```
<lf>[##]<prompt>
```

IRAMP

Sets or displays the infusion rates while ramping. Configuration Run screen mode only.

Command format:

```
iramp [{start rate} {start units} {end rate} {end units}
{ramp time in seconds}]
```

Query response:

```
<lf>[##:]Ramp not set up.<cr>
```

```
<lf>[##]<prompt>
```

or:

```
<lf>[##:]# xl/xxx to xl/xxx in # seconds<cr>
```

```
<lf>[##]<prompt>
```



NOTE: To clear a ramp, use *CTIME* command.

IRATE

Sets or displays the infusion rate. Configuration Run screen mode only. The rate argument may be replaced by "max" or "min" to set the maximum or minimum rate, respectively. "lim" may be used to display the range limits.

Command format:

```
irate [max | min | lim] {rate} {rate units}]
```

Query response:

```
<lf>[##:]# xl/xxx<cr>
```

```
<lf>[##]<prompt>
```

or:

```
<lf>[##:]# xl/xxx to # xl/xxx<cr>
```

```
<lf>[##]<prompt>
```

WRAMP

Sets or displays the withdraw rates while ramping. Configuration Run screen mode only.

Command format:

```
wramp [{start rate} {end rate} {rate units}
{ramp time in seconds}]
```

Query response:

```
<lf>[##:]Ramp not set up.<cr>
```

```
<lf>[##]<prompt>
```

or:

```
<lf>[##:]# xl/xxx to xl/xxx in # seconds<cr>
```

```
<lf>[##]<prompt>
```

WRATE

Sets or displays the withdraw rate. Configuration Run screen mode only. The rate argument may be replaced by "max" or "min" to set the maximum or minimum rate, respectively. "lim" may be used to display the range limits.

Command format:

```
wrate [max | min | lim] {rate} {rate units}]
```

Query response:

```
<lf>[##:]# xl/xxx<cr>
```

```
<lf>[##]<prompt>
```

or:

```
<lf>[##:]# xl/xxx to # xl/xxx<cr>
```

```
<lf>[##]<prompt>
```

Volume commands**CIVOLUME**

Clears the infused volume. Configuration Run screen mode only.

Command format:

```
civolume
```

CTVOLUME

Clears the target volume. Configuration Run screen mode only.

Command format:

```
ctvolume
```

CVOLUME

Clears both the infused and withdrawn volumes. Configuration Run screen mode only.

Command format:

```
cvolume
```

CWVOLUME

Clears the withdrawn volume. Configuration Run screen mode only.

Command format:

```
cwvolume
```

IVOLUME

Displays the infused volume. Configuration Run screen mode only.

Command format:

```
ivolume
```

Query response:

```
<lf>[##:]# xl<cr>
```

```
<lf>[##]<prompt>
```

SVOLUME

Sets or displays syringe volume. Configuration Run screen mode only.

Command format:

svolume

Query response:

<lf>[##.]#.####ul<cr>

<lf>[##]<prompt>

or:

<lf>[##.]#.#### ml<cr>

<lf>[##]<prompt>

TVOLUME

Sets or displays the target volume. Configuration Run screen mode only.

Command format:

tvolume [{target volume} {volume units}]

Query response:

<lf>[##:]Target volume not set<cr>

<lf>[##]<prompt>

or:

<lf>[##:] # xl<cr>

<lf>[##]<prompt>

WVOLUME

Displays the withdrawn volume. Configuration Run screen mode only.

Command format:

wvolume

Query response:

<lf>[##:]# xl<cr>

<lf>[##]<prompt>

Time commands**CITIME**

Clears the infused time. Configuration Run screen mode only.

Command format:

citime

CTIME

Clears both the infused and withdrawn times. Configuration Run screen mode only.

Command format:

ctime

CTIME

Clears the target time. Configuration Run screen mode only.

Command format:

ctime

CWTIME

Clears the withdrawn time. Configuration Run screen mode only.

Command format:

cwtime

ITIME

Displays the infused time. Configuration Run screen mode only.

Command format:

itime

Query response:

<lf>[##:]# seconds<cr>

<lf>[##]<prompt>

or:

<lf>[##:]###.##.##<cr>

<lf>[##]<prompt>

TTIME

Sets or displays the target time. Configuration Run screen mode only.

Command format:

ttime [{target time}]

Query response:

<lf>[##:]Target time not set<cr>

<lf>[##]<prompt>

or:

<lf>[##:]# seconds<cr>

<lf>[##]<prompt>

or:

<lf>[##:]###.##.##<cr>

<lf>[##]<prompt>

WTIME

Displays the withdrawn time. Configuration Run screen mode only.

Command format:

wtime

Query response:

<lf>[##:]# seconds<cr>

<lf>[##]<prompt>

or:

<lf>[##:]###.##.##<cr>

<lf>[##]<prompt>

Digital I/O commands**INPUT**

Reads and displays the trigger input port status.

Command format:

```
input
```

Query response:

```
<lf>[##:]Low.<cr>
```

```
<lf>[##]<prompt>
```

or:

```
<lf>[##:]High.<cr>
```

```
<lf>[##]<prompt>
```

OUTPUT

Sets the level on one of the output ports.

Command format:

```
output {1} {high|low}
```

SYNC

Sets the level on the sync port.

Command format:

```
sync {high|low}
```

Internal commands**STATUS**

Displays the raw status for use with a controlling computer.

Command format:

```
status
```

The output is in three integer fields and one flag field, all separated by spaces and terminated by a carriage return / linefeed pair. The first integer is the current rate in femtoliters per second. The second integer is the infuse time in milliseconds. The time has a granularity of 1 millisecond. The third integer is the infused volume in femtoliters. All three values are for the current direction.

The flag field consists of six flags.

- Flag one is the motor direction and will be "i or I" if the pump is infusing and "w or W" if the pump is withdrawing. If the letter is lower case, the pump motor is idle. If upper case, the pump motor is running.
- Flag two is the limit switch status. If the infuse limit switch was hit, "i or I" is displayed. If the withdraw limit switch was hit, "w or W" is displayed. If no limit switch was hit or the pump does not have limit switches, "." is displayed.
- Flag three is the stall status and will be "S" if the pump has stalled. Otherwise it will be ".".
- Flag four is the trigger input state and will be "T" if high and "." if low.
- Flag five is the direction port state and will be "I" for infuse and "W" for withdraw.
- Flag six is the target reached status. It will be "T" if the target time or volume was reached and "." if not.

ERROR CODES

NOTE: Error and Alarm text are shown in a yellow box whereas Notice, Confirm and Verified are shown in a green box.

Run Mode Errors: Error 1XX

Set-up Errors: Error 2XX

Program Errors: Error 3XX

Critical Errors: Error 4XX

Run Mode Errors

ERROR 101- Power to the pump was lost.

ERROR 102- The A/D convertor is not working.

Set-up Errors

ERROR 201- Backlight setting out of range, 10 to 100

ERROR 202- Alarm setting out of range, 1 to 99

ERROR 203- Force percentage out of range, 1 to 100.

ERROR 204- Pump address out of range, 0 to 99.

ERROR 205- Pump number out of range, 1 to 99.

ERROR 206- Syringe volume out of range, 0.05 μ l to 1000 ml.

ERROR 207- Syringe diameter out of range, 0.1 mm to 99 mm.

ERROR 210- Infuse Rate out of range.

ERROR 211- Withdraw rate out of range.

ERROR 212- Syringe diameter is out of range.

ERROR 213- Target volume exceeds syringe volume.

ERROR 214- Target time exceeds syringe volume.

ERROR 215- Total volume exceeds syringe capacity.

ERROR 216- Volume is less than the minimum value.

ERROR 217- Motor has stalled.

ERROR 218- Program needs a rate.

ERROR 219- Program needs infuse and withdraw rates and a target volume.

Program Errors

ERROR 301- Delay time out of range, must be at least 0.20 seconds.

ERROR 302- Number of steps must be between 2 and 500.

ERROR 306- Download to remote pump incomplete.

ERROR 307- Syringe size and flow rate not compatible, cannot set motor speed.

ERROR 308- File exists.

ERROR 310- Not all fields have been set.

ERROR 311- Rate is out of range.

ERROR 312- Time is out of range.

ERROR 313- Volume is out of range.

ERROR 314- First rate is out of range.

ERROR 315- Second rate is out of range.

ERROR 316- First time is out of range.

ERROR 317- Second time is out of range.

ERROR 318- First volume is out of range.

ERROR 319- Second volume is out of range.

ERROR 320- The pulse count is 0.

ERROR 321- Bad memory sector in step #%. Step was deleted.

ERROR 322- Volume exceeds syringe capacity in step #%.

ERROR 323- Incompatible rate vs. syringe size in step #%.

ERROR 324- Repeat count is 0.

Critical Errors

- ERROR 401- Infuse rate could not be saved to disk. Contact factory.
- ERROR 402- Withdraw rate could not be saved to disk. Contact factory.
- ERROR 403- Program step could not be saved to disk. Contact factory.
- ERROR 404- Program could not be read from disk. Contact factory.
- ERROR 405- Program step could not be read from disk. Contact factory.

Notice

- NOTICE- Screen locked. Press the lock button to unlock.
- NOTICE- Deleting program.
- NOTICE- Importing new program: %s...
- NOTICE- Exporting step #%d...
- NOTICE- Checking program.
- NOTICE- Program is on a time delay. Press here to cancel.
- NOTICE- Waiting for screen press.
- NOTICE- Waiting for an event.
- NOTICE- Copying a program.
- NOTICE- Verify rates and target.
- NOTICE- Withdrawal complete, press to clear alarm.
- NOTICE- Infusion complete, press to clear alarm.

Confirm

- CONFIRM- Press the lock button again, to lock the screen.
- CONFIRM- Press button again to delete this program.
- CONFIRM- Press button again to delete step.

Verified

- VERIFIED- Program was copied.
- VERIFIED- Program was exported successfully.
- VERIFIED- Added step #%d...
- VERIFIED- Program was successfully imported.

Alarm

- ALARM- Pump is due for maintenance.

Appendices

APPENDIX A: SYRINGE VOLUME/DIAMETER REFERENCE TABLE

KD Scientific Stainless Steel

Size	Diameter
2.5 ml	4.851 mm
8	9.525
20	19.13
50	28.6

Air-Tite HSW Norm-Ject

Size	Diameter
1 ml	4.69 mm
2.5	9.65
5	12.45
10	15.9
20	20.05
30	22.9
50	29.2

Becton Dickinson 'Plasti-pak'

Size	Diameter
1 ml	4.699 mm
3	8.585
5	11.989
10	14.427
20	19.05
30	21.59
50	26.594
60	26.594

Terumo Japan

Size	Diameter
1 ml tb	4.7 mm
1 ml vc	6.5 mm
2.5	9.0
5	13.0
10	15.8
20	20.2
30	23.2
50	29.2

SGE Scientific Glass Engineering

Size	Diameter
5 µl	0.343 mm
10	0.485
25	0.728
50	1.03
100	1.457
250	2.303
500	3.257
1 ml	4.606 mm
2.5	7.284
5	10.301
10	14.567
25	23
50	27.5

Hamilton Glass - All Types

Size	Diameter
0.5 µl	0.103 mm
1	0.1457
2	0.206
5	0.330*
5	0.343**
10	0.485**
10	0.461***
25	0.729
50	1.03
100	1.457
250	2.304
500	3.256
1 ml	4.608 mm
1.25	5.151
2.5	7.285
5	10.3
10	14.567
25	23.033
50	32.573

* = Series 7000
 ** = Series 700
 *** = Series 1700

Cadence Science, Inc. Formerly Popper & Sons MICRO-MATE Glass

Size	Diameter
0.25 ml	3.47 mm
0.5	3.62
1	4.82
2	8.91
3	8.91
5	11.71
10	14.65
20	19.56
30	22.7
50	28.02

Becton Dickinson Glass-All Types

Size	Diameter
0.5 ml	4.64 mm
1	4.64
2.5	8.66
5	11.86
10	14.34
20	19.13
30	22.7
50	28.6

KD Scientific Glass

Size	Diameter
1 ml	4.80 mm
2	6.45
5	12.60
10	15.50
20	20.40
30	22.90
50	27.45

ILS Glass

Size	Diameter
250 µl	2.303 mm
500	3.260
1 ml	4.606 mm
2.5	7.280
5	10.300
10	14.567
25	23.032
50	32.573

Sherwood-Monoject Plastic

Size	Diameter
1 ml	4.674 mm
3	8.865
6	12.600
12	15.621
20	20.142
35	23.571
60	26.568

Hoshi

Size	Diameter
1 ml	6.50 mm
2	9.10
3	10.00
5	12.60
10	15.10
20	20.45
30	22.50
50	25.60

Top

Size	Diameter
1 ml	6.40 mm
2.5	9.30
5	13.10
10	15.3
20	21.0
30	23.0
50	29.0

Nipro

Size	Diameter
1 ml long	6.6 mm
1 ml short	4.7
2.5 ml	9.0
5	13.0
10	15.8
20	20.1
30	23.2
50	29.1

Suggested Force Level Settings for Common Syringes

Syringe Type/Material	Capacity	Force Setting	Common Manufacturer(s)
Plastic Syringes	≤5 ml	50%	BD plastic, Sherwood, Airtite, Terumo
	>5 ml	100%	
Stainless Steel	All	100%	KDS, Cole-Parmer
Glass/Glass	≤20 ml	30%	KDS Glass, Cadence (Popper)
	>20 ml	50%	
Glass/Plastic	≤1000 µl	30%	Hamilton, SGE
	≤5 ml	50%	
	>5 ml	100%	

APPENDIX B: LEGATO 100, 101, 110 & 111 MIN/MAX FLOW RATES

Nominal Minimum/Maximum Flow Rates for Various Syringes. (Actual Limits will vary depending on syringe manufacturer)					
Syringe Size	Syringe ID	Minimum Rate	Units	Maximum Rate	Units
0.5 µl	0.103 mm	1.26000	pl/min	1.32611	µl/min
1 µl	0.1457 mm	2.52000	pl/min	2.65353	µl/min
2 µl	0.206 mm	5.10000	pl/min	5.30443	µl/min
5 µl	0.343 mm	14.1600	pl/min	14.7059	µl/min
10 µl	0.485 mm	28.2600	pl/min	29.4028	µl/min
25 µl	0.729 mm	63.9600	pl/min	66.4293	µl/min
50 µl	1.030 mm	127.680	pl/min	132.611	µl/min
100 µl	1.457 mm	255.480	pl/min	265.353	µl/min
250 µl	2.304 mm	638.940	pl/min	663.544	µl/min
500 µl	3.256 mm	1.27608	nl/min	1.32518	ml/min
1 ml	4.608 mm	2.55582	nl/min	2.65417	ml/min
1 ml	4.699 mm	2.65776	nl/min	2.76004	ml/min
3 ml	8.585 mm	8.87142	nl/min	9.21266	ml/min
5 ml	11.989 mm	17.3013	nl/min	17.9668	ml/min
10 ml	14.427 mm	25.0534	nl/min	26.0170	ml/min
20 ml*	19.050 mm	43.6821	nl/min	45.3622	ml/min
30 ml*	21.590 mm	56.1073	nl/min	58.2653	ml/min
60 ml*	26.594 mm	85.1297	nl/min	88.4040	ml/min

* Not available on Legato 101 and 111. These pumps work with 0.5 µl to 10 ml syringes

LEGATO 180 MIN/MAX FLOW RATES

Nominal Minimum/Maximum Flow Rates for Various Syringes. (Actual Limits will vary depending on syringe manufacturer)					
Syringe Size	Syringe ID	Minimum Rate	Units	Maximum Rate	Units
0.5 µl	0.103 mm	0.54000	pl/min	596.496	nl/min
1 µl	0.1457 mm	1.14000	pl/min	1.19358	µl/min
2 µl	0.206 mm	2.28000	pl/min	2.38598	µl/min
5 µl	0.343 mm	6.36000	pl/min	6.61487	µl/min
10 µl	0.485 mm	12.7200	pl/min	13.2256	µl/min
25 µl	0.729 mm	28.7400	pl/min	29.8805	µl/min
50 µl	1.030 mm	57.4200	pl/min	59.6496	µl/min
100 µl	1.457 mm	114.900	pl/min	119.350	µl/min
250 µl	2.304 mm	287.400	pl/min	298.468	µl/min
500 µl	3.256 mm	573.960	pl/min	596.076	µl/min
1 ml	4.608 mm	1.14960	nl/min	1.19387	ml/min
1 ml	4.699 mm	1.19550	nl/min	1.24149	ml/min
3 ml	8.585 mm	3.99042	nl/min	4.14394	ml/min
5 ml	11.989 mm	7.78230	nl/min	8.08163	ml/min
10 ml	14.427 mm	11.2692	nl/min	11.7027	ml/min

APPENDIX C: EXTERNAL CONNECTIONS

User I/O Connector Specifications

Pin Assignments

1. **Direction control input**
Rising edge sets pump to infuse
Falling edge sets pump to refill
2. **Trigger Input**
Event trigger – falling edge triggers a program event
3. **Footswitch Input (or Timer)**
Settable to work as:
-Momentary switch closure to ground or TTL Logic Low; falling edge toggles between states (run/stop)
-Starts on rising edge, stops on falling edge
-Starts on falling edge, stops on rising edge
4. **Trigger 1 Output**
TTL Logic Output-Default = Low Control thru program or serial comm
6. **Sync Output**
TTL Logic Output –
Rising Edge = Start Infuse
Falling Edge= Start Refill
7. **Direction Output**
TTL Logic Output –
High = Refill
Low = Infuse
- 9-13. **Signal Return / Ground**
14. **Run Indicator Voltage**
+5V through a 470 ohm resistor (connect to LED Anode)
15. **Run Indicator Output**
TTL Logic Output, active low (low = run) (connect to LED Cathode)

Electrical Specifications

Inputs:	$V_{IH} \geq 2V$	$I_{IH} \leq 20\mu A$
	$V_{IL} \leq 0.4V$	$I_{IL} \leq 0.5mA$
Outputs:	$V_{OH} \geq 3.8V$	$I_{OH} \leq 6mA$
	$V_{OL} \leq 0.4V$	$I_{OL} \leq 6mA$

All Inputs are pulled high to +5 Vdc through a 10k resistor All Outputs are at TTL Logic Levels. Pulse duration should be 0.1s minimum.

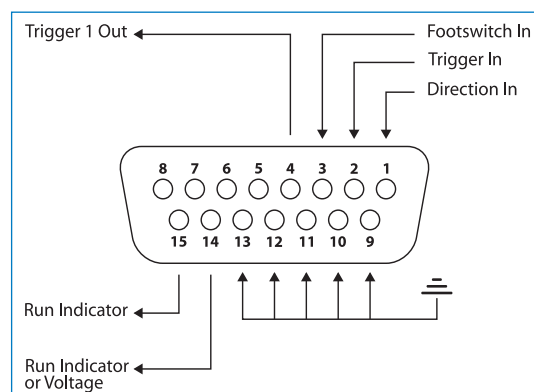

User I/O Connector Specifications

Utilizing the USB Interface

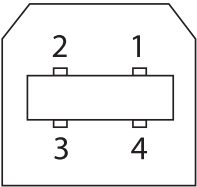
Mating Face		Pin #	Signal
		1	+5V
		2	- Data
		3	+ Data
		4	GND

USB VIRTUAL COMMPORT DRIVER INSTALLATION

When you connect the KDS Legato 100 Series pump to a computer via USB for the first time, Windows will seek to install a driver for communication. The following section details the installation of the Virtual CommPort Driver supplied with the KDS Legato 100 Series Pump.

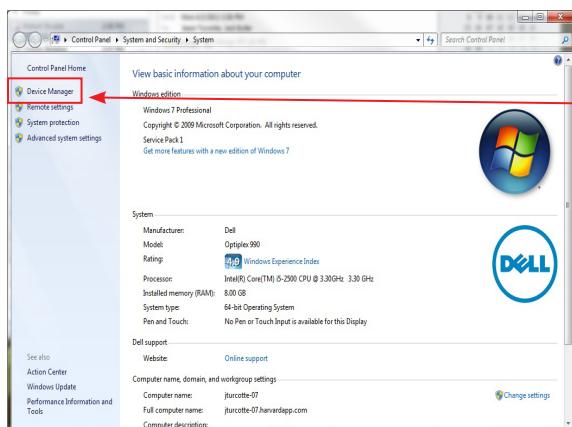

1. Connect the pump to the computer via USB. Open the control panel and select System and Security and then System. Click Device Manager on the left hand menu.

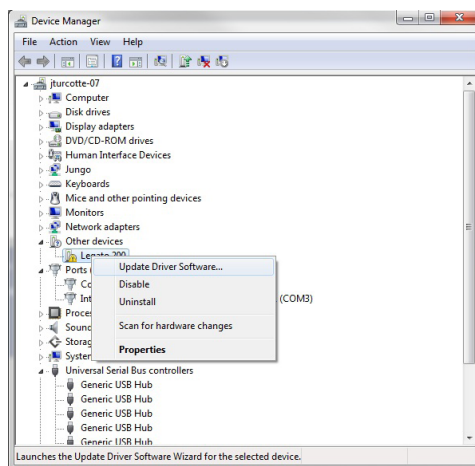

2. Two Flash Update Applications will be displayed in the device manager, under Other Devices. Right click on either of the flash update applications and select Update Driver Software.

USB VIRTUAL COMMPORT DRIVER INSTALLATION (CONTINUED)

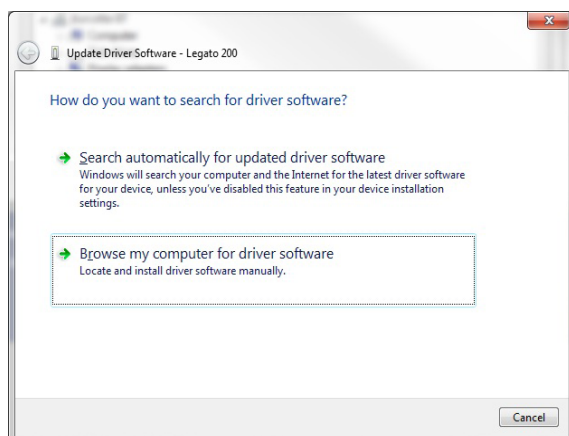

3. Select Browse my computer for driver software.

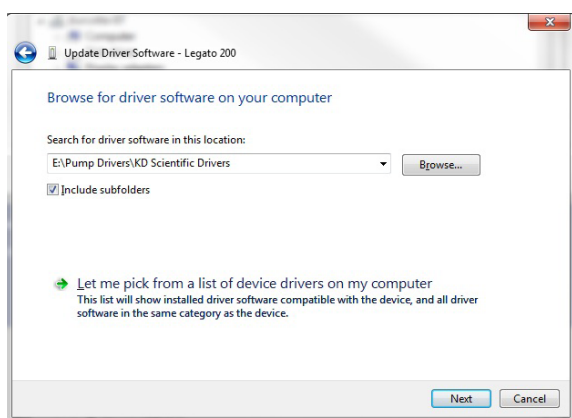

4. Click Browse and navigate to the pump drivers folder located on the CD supplied with the pump. Select the file KDS Scientific USB-CDC.inf. Make sure the Include Subfolders box is checked and then click Next.

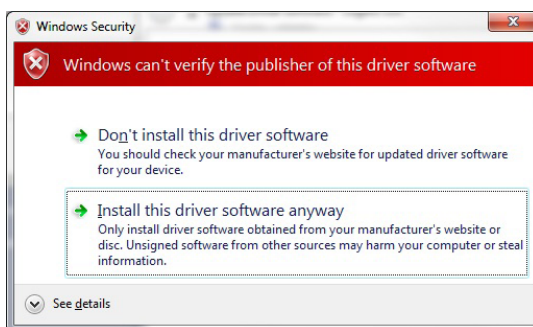

5. If a warning message regarding the driver publisher is displayed, choose Install this driver software anyway.

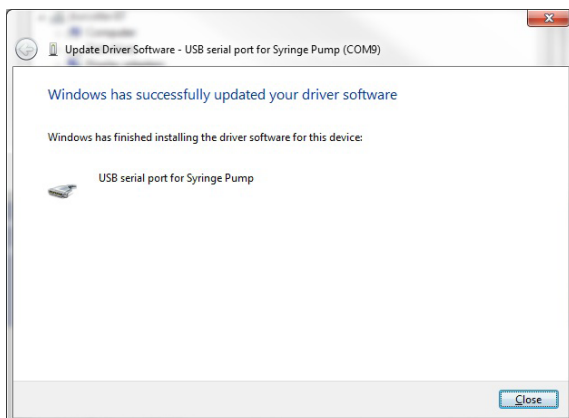

6. Click Close after the software has been successfully installed.

RS-485



CAUTION: DO NOT CONNECT TO FIREWIRE PORTS ON A PC. DAMAGE MAY OCCUR TO PUMP AND/OR PC.

Pin #	RS-485 In Signal	RS-485 Out Signal	Notes
1	PWR IN	PWR OUT (+30V)*	* Protected by resettable fuse
2	GND	GND	
3	RS-485 A	TIED TO PIN 4**	** 100 Ω, ½ w to GND termination
4	RS-485 B	TIED TO PIN 3**	
5	TIED TO PIN 6**	RS-485 A	
6	TIED TO PIN 5**	RS-485 B	

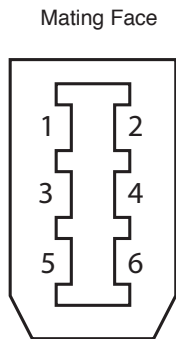

RS-485 In/Out - IEEE-1394 Sockets

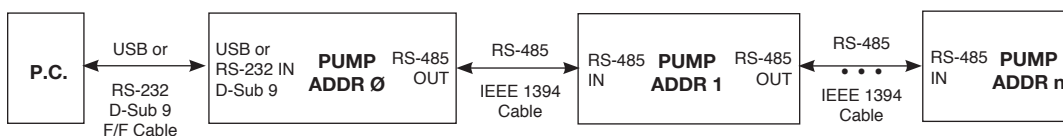

Daisy-Chaining via RS-485

RS-485 Dasiy Chain Connection Options:

- If all pumps have software versions 2.0.0 or higher, 99 pumps in chain.
- If all pumps have software versions 1.0.4 or lower, 99 pumps in chain.
- If mix of pumps with software version 1.0.4 or lower and 2.0.0 or higher, maximum of 5 pumps in chain and 1 RS-485 adapter (catalog # 78-8339) required.

- NOTE:** If a larger chain of pumps with mixed software versions is desired, pumps with software versions 1.0.4 or lower can be returned to manufacturer for a hardware update.
- NOTE:** When applying power to pumps in a daisy chain, apply power to the last group in the chain first and work backwards.
- NOTE:** When removing power, be aware that power removed from a stand-alone unit will cause power to be removed from all RS-485 powered units deriving power from that stand-alone unit.
- NOTE:** Power may be removed from any group of pumps, except the first group, without affecting communications "downstream"
- NOTE:** Each pump in the daisy-chain must have a unique address. The first pump must be set to address 00.

APPENDIX D: MAINTENANCE

Maintenance

KDS Legato 100 Series pumps require no special maintenance other than keeping them clean by avoiding accidental spills of pumped material. Refer to the chemical compatibility chart below for specific chemical resistance information.

The two guide rods and the lead screw should be sparingly lubricated periodically; every 100 hrs the pump will remind you. The guide rods and the lead screw should be lubricated with Super Lube Synthetic Grease provided with the pump.

To clean the exterior surfaces, use a lint-free cloth to remove loose dust. Use care to avoid scratching the clear display window. For more efficient cleaning, use a soft cloth dampened [not soaked] with water, an aqueous solution of 75% isopropyl alcohol, or a mild detergent.

Chemical Compatibility Chart			
Chemical	Concentration	Overlay Cover	Overlay Adhesive
Acetonitrile	99.5%	A	A
Methyl alcohol	99.8%	A	-
Hydrochloric Acid	36.5%	A	A
Bleach	100%	A	A
Windex®	100%	A	A
Isopropyl Alcohol	99.5%	A	D
Dish Soap	-	A	A
Motor Oil	100%	A	A
Simple Green	100%	A	A
Gasoline	100%	A	D
Ethylene Glycol (Antifreeze)	100%	A	A
Mineral Oil	100%	A	A
Ammonia	27.0%	A	A
Magnalube	100%	A	A
Superlube	100%	A	A
Acetone	99.5%	A	D
Soda (Coca-Cola)®	100%	A	A
Sulfuric Acid	95.0%	D	D
Dimethyl Sulfoxide	99.9%	A	C
Sodium Hydroxide	50%	A	A
Nitric Acid	68.0%	D	D
Chloroform	100%	D	D

A Satisfactory
 B Fair, Minor Effects
 C Poor, Moderate Effects
 D Severe Effects
 - not tested

The chemical resistance data provided is for reference only. The data is based on the manufacturer's recommendations and is not a guarantee of chemical compatibility for your test conditions. Wipe any spills immediately.

Upgrading Legato 100 Series Software



NOTE: Prior to upgrading, users will need to install the KDS Legato 100 Series USB driver as well as the bootloader driver file (KDS Legato 100 Series-Bootloader.inf). Reference "USB Virtual Comport Driver Installation".

1. Upload the latest software version to your desktop (format is filename.srec).
2. Disconnect all I/O devices and then connect the pump to PC using a USB cable.
3. On the Set up screen of the pump, press the Upgrade Software button twice to enter "Boot Loader Mode".



NOTE: To exit boot loader mode without upgrading the software, power cycle the pump.

4. From the CD provided with the pump, open the Legato 100 Series Pump Updater Application.

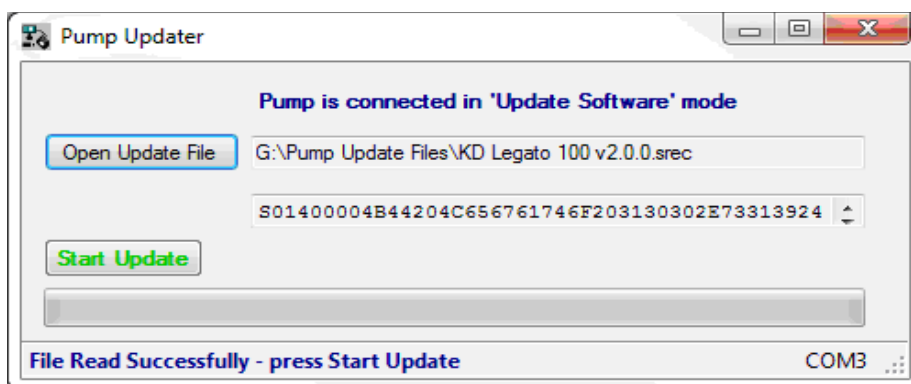

5. Click Open Update File and browse to the file previously saved on your desktop and click Open.
6. Click Start Update.

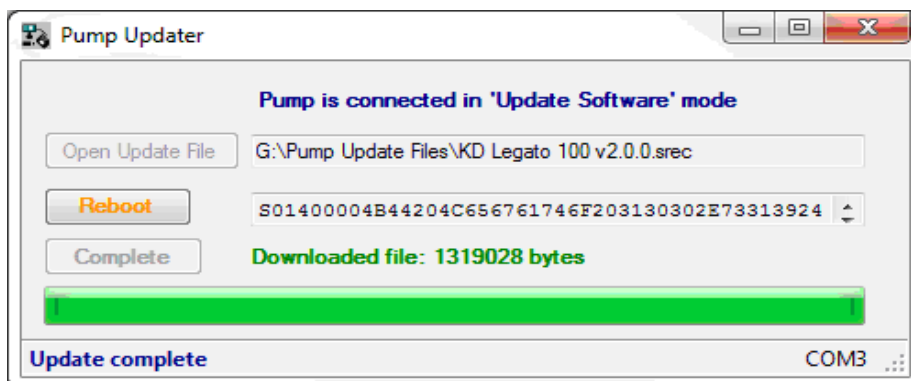

7. After the update is complete, press Reboot to power cycle the pump.

TROUBLESHOOTING

1. Infusion Accuracy

To ensure infusion accuracy always use new syringe(s) and measure syringe bore diameter and enter actual dimensions in millimeters (mm) using the Custom Syringe entry option. Additionally, make sure that the guide rods and lead screw are properly lubricated.



NOTE: It is recommended that you save your programs periodically by uploading them to a PC.

KDS Legato 100 Series Display Error Messages

2. Motor Stalled

This indicates that the pusher block travel has been impeded. This may be caused by the syringe plunger hitting bottom, a kink in the tubing (occlusion), syringe plunger binding or any situation requiring more force to the head of the syringe than the pump is capable of delivering. To restart the pump, remove the cause of stalling and/or increase the force setting, then press RUN. The pump will continue the interrupted procedure where it stopped.

3. Out of Range

A value was entered or encountered in a pump program that was beyond the pump's limits.

4. Power Failure Notification

If power to the pump is interrupted during operation, an alarm will sound to alert the user to the interruption. When power is restored, an onscreen message is displayed to indicate the interruption.

5. Unit Won't Power Up

Verify the the Power Source Switch on the rear of the pump is set to DC-IN if powering through power supply or RS-485 if powering in a chain.

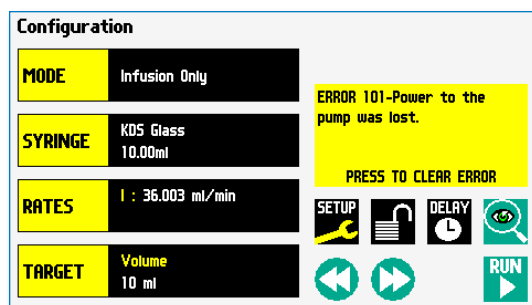

The KDS Legato 100 Series Pump will notify you of a power failure with a message when power is restored

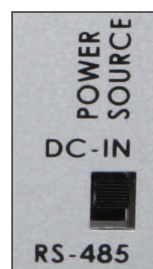

APPENDIX E: ORDERING INFORMATION

Item No. Description

Model Versions

788100 Legato 100, Infuse Only,
Single Syringe

788110 Legato 110, Infuse/Withdraw,
Programmable, Single Syringe

788101 Legato 101, Infuse Only,
Dual Syringe

788111 Legato 111, Infuse/Withdraw,
Programmable, Dual Syringe

788180 Legato 180, Infuse/Withdraw,
Programmable, Dual Syringe

Accessories

788333 Auto Fill Valve Box Low Pressure

788336 Auto Fill Valve Box Medium Pressure

788338 Auto Fill Valve Box High Pressure

788332 Continuous Delivery Valve Box Low Pressure

788335 Continuous Delivery Valve Box Medium
Pressure

788337 Continuous Delivery Valve Box High
Pressure

788325 Anti Siphon Kit, Single Syringe

788331 Anti Siphon Kit, Dual Syringe

788304 RS485 Pump to Pump Communication, .5 m

788305 RS485 Pump to Pump Communication, 2 m

788306 USB Cable PC to Pump Communication, 2 m

788307 USB Cable PC to Pump Communication, 5 m

788326 Line Cord US 115 V, with Power Supply

788327 Line Cord European, with Power Supply

788328 Line Cord UK, with Power Supply

788312 Adapter Digital I/O (15 pin to 9 pin)

788313 Adapter D Sub 15 to Terminal Block

780225 Footswitch with Phono Jack Plug

788314 Adapter for 25 ml and 50 ml Hamilton
Gastight Syringe

788315 Hex Key

788316 Lubricant SuperLube, 1 cc

788324 Protective Shield for display

788329 Upgrade Infuse Only to Infuse/Withdraw,
Single Syringe

788330 Upgrade Infuse Only to Infuse/Withdraw,
Dual Syringe

788339 Adapter RS-485 (See Appendix C: External
Connections)