

[Gebrauchsanleitung](#) | [Operating manual](#) | [Mode d'emploi](#) | [Instrucciones de manejo](#) | [Istruzione](#) | [Instruções de utilização](#) | [操作手册](#) | [Руководство по эксплуатации](#) | [사용지침](#) | [Bruksanvisning](#) | [使用説明書](#) | [Használati utasítás](#) | [Návod k použití](#) | [Gebruiksaanwijzing](#) | [Instrukcja użytkowania](#) | [Kullanım Talimatları](#)



accu-jet[®] S

Pipettierhelfer | Pipette controllers

Impressum

BRAND GMBH + CO KG

Otto-Schott-Str. 25
97877 Wertheim (Germany)

T +49 9342 808 0
F +49 9342 808 98000
info@brand.de
www.brand.de

Do you need more operating manuals and translations?
Please refer to <http://www.brand.de/om> or use the following
Quick Response Code:



The original operating manual is in German. Other languages
are translations of the original operating manual.

EU-Konformitätserklärung | EU Declaration of Conformity

Produktbezeichnung: Product name:	Pipettierhelfer accu-jet® S / Pipetting controller accu-jet® S
Produktvarianten: Product variations:	Anthrazit, Beere, Petrol, Amethyst / anthracite, berry, petrol, amethyst
Art-Nr. / Cat.-No.	26350, 26351, 26352, 26353, 26360, 26361, 26362, 26363

Das oben beschriebene Produkt entspricht den grundlegenden Anforderungen, die in den nachfolgend bezeichneten Harmonisierungsrechtsvorschriften festgelegt sind: The product described above meets the basic requirements that are specified in the harmonization legislation listed below:	Angewendete harmonisierte Normen: Applied harmonized standards:
RoHS: 2011/65/EU incl.2015/863/EU EMC: 2014/30/EU	EN IEC 63000:2018 EN 61326-1:2013
Weitere angewendete Normen: Other applied standards:	Geltungsbereich: Scope:
EN 61010-1:2010, EN 61010-1:2010/A1:2019/AC:2019-04 EN/IEC 62368-1:2014 (angewendet auf Fremdherstellernetzteil / applied to third-party power supply)	NRL / LVD NRL / LVD

Die alleinige Verantwortung für die Ausstellung dieser Konformitätserklärung in Bezug auf die Erfüllung der grundlegenden Anforderungen und die Anfertigung der technischen Unterlagen trägt der Hersteller.

The manufacturer is solely responsible for issuing this declaration of conformity with regard to meeting the essential requirements and preparing the technical documentation.

Hersteller / Manufacturer	Adresse / Address
BRAND GMBH + CO KG	Otto-Schott-Str. 25 97877 Wertheim Germany

Wertheim, 01. Juli 2022 / 01 July 2022



Patrick Ziemeck
Managing Director Technology



i.A. Siegfried Ott
Regulatory Affairs

Diese Erklärung bescheinigt die Übereinstimmung mit den genannten Harmonisierungsvorschriften, beinhaltet jedoch keine Zusicherung von Eigenschaften.

This document declares the accordance with the named harmonized regulations, but does not assure specific properties.

UK Declaration of Conformity

Product name: Pipetting controller accu-jet® S
Product variations: anthracite, berry, petrol, amethyst
Cat.-No. 26350, 26351, 26352, 26353, 26360, 26361, 26362, 26363

The product described above meets the basic requirements that are specified in the harmonization legislation listed below:	Applied harmonized standards:
The Restriction of the Use of Certain Hazardous Substances in Electrical and Electronic Equipment Regulations 2012 (SI 2012 No. 3032)	EN IEC 63000:2018
Electromagnetic Compatibility Regulations 2016 (SI 2016 No. 1091, as amended by SI 2019 No. 696)	EN 61326-1:2013
Other applied standards:	Scope:
EN 61010-1:2010, EN 61010-1:2010/A1:2019/AC:2019-04 EN/IEC 62368-1:2014 (angewendet auf Fremdherstellernetzteil / applied to third-party power supply)	LVD LVD

The manufacturer is solely responsible for issuing this declaration of conformity with regard to meeting the essential requirements and preparing the technical documentation.

Manufacturer	Address
BRAND GMBH + CO KG	Otto-Schott-Str. 25 97877 Wertheim Germany

Wertheim, 18 February 2022



Patrick Ziemeck
Managing Director Technology



i.A. Siegfried Ott
Regulatory Affairs

This document declares the accordance with the named harmonized regulations, but does not assure specific properties.

Declaration of conformity – China RoHS 2

BRAND GMBH + CO KG has made reasonable efforts to ensure that hazardous materials and substances may not be used in BRAND products.

In order to determine the concentration of hazardous substances in all homogeneous materials of the subassemblies, a “Product Conformity Assessment” (PCA) procedure was performed. As defined in GB/T 26572 the “Maximum Concentration Value” limits (MCV) apply to these restricted substances:

+ Lead (Pb):	0.1%	+ Hexavalent chromium (Cr(+VI)):	0.1%
+ Mercury (Hg):	0.1%	+ Polybrominated biphenyls (PBB):	0.1%
+ Cadmium (Cd):	0.01%	+ Polybrominated diphenyl ether (PBDE):	0.1%

Environmental Friendly Use Period (EFUP)

EFUP defines the period in years during which the hazardous substances contained in electrical and electronic products will not leak or mutate under normal operating conditions. During normal use by the user such electrical and electronic products will not result in serious environmental pollution, cause serious bodily injury or damage to the user's assets.

The Environmental Friendly Use Period for BRAND instruments is 40 years.



Material Content Declaration for BRAND Products

部件名称 Part name	有毒有害物质或元素 Hazardous substances					
	铅 Pb	汞 Hg	镉 Cd	六价铬 Cr(+VI)	多溴联苯 PBB	多溴二苯醚 PBDE
包装 / Packaging	0	0	0	0	0	0
塑料外壳 / 组件 Plastic housing / parts	0	0	0	0	0	0
电池 / Battery	0	0	0	0	0	0
玻璃 / Glass	0	0	0	0	0	0
电子电气组件 Electrical and electronic parts	X	0	0	0	0	0
金属外壳 / 组件 Metal housing / parts	X	0	0	0	0	0
电机 / Motor	X	0	0	0	0	0
配件 / Accessories	X	0	0	0	0	0

此表格是按照SJ/T 11364-2014中规定所制定的。

This table is created according to SJ/T 11364-2014.

- O: 表示该有毒有害物质在该部件所有均质材料中的含量均在GB/T 26572规定的限量要求以下。
O: Indicates that the above mentioned hazardous substance contained in all homogeneous materials of the part is below the required limit as defined in GB/T 26572.
- X: 表示该有毒有害物质至少在该部件某一均质材料中的含量超出GB/T 26572规定的限量要求。
X: Indicates that the above mentioned hazardous substance contained in at least one of the homogeneous materials of this part is above the required limit as defined in GB/T 26572.

注释： 电池，玻璃制品和配件可能不属于此设备的一部分且/或可能有它自己的EFUP标志且/或可能包含更改EFUP标志的部件。

Note: Batteries, glassware and accessories might not be content of the enclosed device and/or may have their own EFUP-marking and/or might be maintaining parts with changing EFUP-marking.

除上表所示信息外，还需声明的是，这些部件并非是有用铅 (Pb), 汞 (Hg), 镉 (Cd), 六价铬 (Cr(+VI)), 多溴联苯 (PBB) 或多溴二苯醚 (PBDE) 来制造的。

Apart from the disclosures in the above table, the subassemblies are not intentionally manufactured or formulated with lead (Pb), mercury (Hg), cadmium (Cd), hexavalent chromium (Cr+VI), polybrominated biphenyls (PBB), and polybrominated diphenyl ethers (PBDE).

Products manufactured by BRAND may enter into further devices or can be used together with other appliances. With these third party products and appliances in particular, please note the EFUP labeled on these products. BRAND will not take responsibility for the EFUP of those products and appliances.

Place, date: Wertheim, 05|04|2022



Patrick Ziemeck
(Managing Director Technology)



i.A. Siegfried Ott
(Regulatory Affairs)

Inhaltsverzeichnis

1	Einleitung	9
1.1	Lieferumfang	9
1.2	Gebrauchsbestimmung	9
2	Sicherheit	11
2.1	Funktion.....	12
2.2	Einsatzgrenzen	12
2.3	Einsatzausschlüsse	13
2.4	Lagerbedingungen.....	13
3	Funktions- und Bedienelemente	14
4	Inbetriebnahme	16
4.1	Akku anschließen	16
4.2	Akku laden	18
4.3	Gerät starten.....	19
4.4	Betriebsart wählen.....	19
4.5	Flüssigkeit aufsaugen oder abgeben	19
4.6	Pipettiergeschwindigkeit verändern.....	20
4.7	Motordrehzahl einstellen.....	20
4.8	Gerät aufbewahren	20
5	Pipettieren	22
6	Reinigung	24
6.1	Dichtigkeit prüfen	24
6.2	Filter austauschen und Adapter reinigen	24
6.3	UV-Entkeimung	27
7	Störung - Was tun?	28
8	Technische Daten	29
8.1	Kennzeichnung auf dem Produkt.....	29

9 Reparatur	30
9.1 Zur Reparatur einsenden	30
10 Bestellinformationen	32
10.1 Gerät	32
10.2 Ersatzteile	32
11 Mängelhaftung	34
12 Entsorgung	35

1 Einleitung

1.1 Lieferumfang

Pipettierhelfer, Nickel-Metallhydrid Akku, Netzteil optional (unterschiedliche Bestellnummern beachten), 2 Ersatzmembranfilter 0,2 µm, Wandhalter, Gebrauchsanleitung

1.2 Gebrauchsbestimmung





- Lesen Sie die Gebrauchsanleitung vor dem ersten Gebrauch sorgfältig durch.
- Die Gebrauchsanleitung ist Teil des Geräts und muss leicht zugänglich aufbewahrt werden.
- Legen Sie die Gebrauchsanleitung bei, wenn Sie dieses Gerät an Dritte weitergeben.

1.2.1 Gefährdungsstufen

Folgende Signalworte kennzeichnen mögliche Gefährdungen:

Signalwort	Bedeutung
GEFAHR	Führt zu schwerer Verletzung oder Tod.
WARNUNG	Kann zu schwerer Verletzung oder Tod führen.
VORSICHT	Kann zu leichten oder mittleren Verletzungen führen.
HINWEIS	Kann zu einer Sachbeschädigung führen.

1.2.2 Symbole der Gebrauchsanleitung

Symbol	Bedeutung	Symbol	Bedeutung
	Gefahrenstelle		Explosionsgefahr
	Augenschutz tragen		Schutzhandschuhe tragen

1.2.3 Darstellung

Darstellung	Bedeutung	Darstellung	Bedeutung
1. Task	Kennzeichnet eine Aufgabe.	>	Kennzeichnet eine Voraussetzung.
a., b., c.	Kennzeichnet einzelne Schritte der Aufgabe.	⇒	Kennzeichnet ein Ergebnis.

2 Sicherheit

Bitte unbedingt sorgfältig durchlesen!

Das Laborgerät accu-jet® S kann in Kombination mit gefährlichen Materialien, Arbeitsvorgängen und Apparaturen verwendet werden. Die Gebrauchsanleitung kann jedoch nicht alle Sicherheitsprobleme aufzeigen, die hierbei eventuell auftreten. Es liegt in der Verantwortung des Anwenders, die Einhaltung der Sicherheits- und Gesundheitsvorschriften sicherzustellen und die entsprechenden Einschränkungen vor Gebrauch festzulegen.

1. Jeder Anwender muss diese Gebrauchsanleitung vor Gebrauch des Gerätes gelesen haben und beachten.
2. Allgemeine Gefahrenhinweise und Sicherheitsvorschriften befolgen, z.B. Schutzkleidung, Augenschutz und Schutzhandschuhe tragen.
3. Angaben der Reagenzienhersteller beachten.
4. Gerät nicht in explosionsgefährdeter Atmosphäre betreiben und keine leicht entzündlichen Medien pipettieren.
5. Gerät nur zum Pipettieren von Flüssigkeiten und nur im Rahmen der definierten Einsatzgrenzen einsetzen. Einsatzausschlüsse beachten, siehe Einsatzausschlüsse, S. 13 ! Bei Zweifel unbedingt an den Hersteller oder Händler wenden.
6. Stets so arbeiten, dass weder der Anwender noch andere Personen gefährdet werden. Spritzer vermeiden. Nur geeignete Gefäße verwenden.
7. Nie Gewalt anwenden.
8. Nur Originalzubehör und Originalersatzteile verwenden. Keine technischen Veränderungen vornehmen. Das Gerät nicht weiter zerlegen, als in der Gebrauchsanleitung beschrieben ist!
9. Vor Verwendung stets den ordnungsgemäßen Zustand des Gerätes prüfen. Sollten sich Störungen des Gerätes ankündigen, sofort aufhören zu pipettieren und das Kapitel Störung - Was tun? befolgen. Ggf. an den Hersteller wenden.

10. Zum Aufladen des Nickel-Metallhydrid-Akkus darf nur das Originalnetzteil verwendet werden.
11. Der Akku darf nicht gegen Akkus anderer Hersteller getauscht werden.
12. Das Netzteil ist vor Feuchtigkeit zu schützen und darf nur in Verbindung mit diesem Gerät betrieben werden.
13. Das Netzteil nicht mehr verwenden, wenn die Anschlussleitung beschädigt ist.
14. Reparaturen und Eingriffe in das Gerät dürfen nur durch autorisierte Servicetechniker durchgeführt werden.

2.1 Funktion

Das Gerät dient als Hilfe zum Pipettieren von Flüssigkeiten mit Mess- und Vollpipetten aus Glas oder Kunststoff im Volumenbereich von 0,1 ml bis 200 ml und mit einem Saugrohr-Außendurchmesser $< 9,2$ mm. Bei richtiger Handhabung kommt die pipettierte Flüssigkeit nur mit der Pipette in Kontakt.

2.2 Einsatzgrenzen

Das Gerät dient zum Pipettieren von Flüssigkeiten unter Beachtung folgender physikalischer Grenzen:

- von $+10$ °C bis $+40$ °C (von 50 °F bis 104 °F) (Gerät und Reagenz)
- Dampfdruck bis max. 500 mbar. Oberhalb von 300 mbar langsam aufsaugen, um Sieden der Flüssigkeit zu vermeiden.
- Dichte bis 9 g/cm^3

2.3 Einsatzausschlüsse

Das Gerät darf nicht für Flüssigkeiten eingesetzt werden, deren Dämpfe korrodierend wirken bzw. die Materialien Silikon oder EPDM angreifen.

Das Gerät ist nicht geeignet für den Gebrauch mit Pasteurpipetten.

WARNUNG



Gerätebetrieb in explosionsgefährdeter Umgebung

Das Gerät darf nicht in explosionsgefährdeter Umgebung betrieben oder geladen werden. Es dürfen keine leichtentzündlichen Medien pipettiert werden (Flammpunkt unter 0 °C (32 °F) z.B. Ether, Aceton).

2.4 Lagerbedingungen

Gerät und Zubehör nur im gereinigten Zustand kühl und trocken lagern.

Lagertemperatur: von -20 °C bis + 50 °C (von -4 °F bis 122 °F).

Relative Luftfeuchtigkeit: 5 % bis 95 %.

3 Funktions- und Bedienelemente

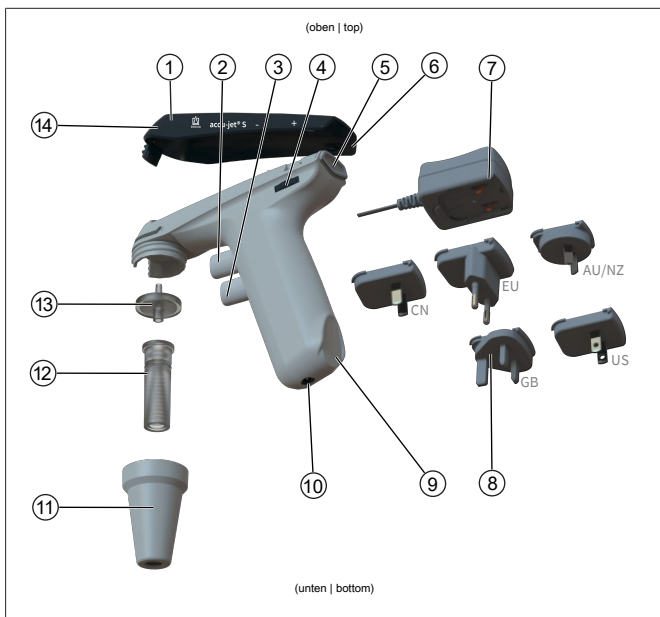

- | | |
|---|--|
| 1 Gehäuseoberschale | 2 Oberer Pipettierknopf (Flüssigkeit aufnehmen) |
| 3 Unterer Pipettierknopf (Flüssigkeit abgeben) | 4 Einstellrad für Motordrehzahl |
| 5 Wahlschalter für Betriebsart | 6 Stellfläche Gehäuseoberschale |
| 7 Netzteil | 8 Länderadapter |
| 9 Stellfläche Griff | 10 Ladebuchse |
| 11 Adaptergehäuse (PP) | 12 Adapter/Rückschlagventil (SI/PTFE) |
| 13 Membranfilter (PP/PTFE) | 14 Druckausgleichsöffnung |

Angaben zu Spannung und Stromaufnahme, siehe Technische Daten, S. 29.

Abk.	Material
PP	Polypropylen
PTFE	Polytetrafluorethylen
SI	Silikon

4 Inbetriebnahme

4.1 Akku anschließen

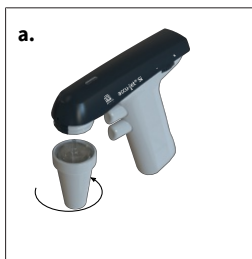

- a.** Adaptergehäuse abschrauben. Adapter und Filter verbleiben im Adaptergehäuse.

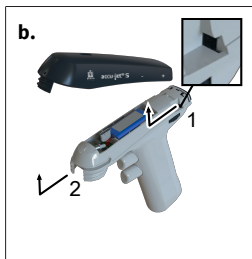

- b.** Gehäuse abnehmen. Gehäuse leicht in Richtung Verschraubung des Adaptergehäuses schieben.

⇒ Das Gehäuse löst sich aus den Aussparungen oberhalb des Einstellrads (1) und aus der Verschraubung des Adaptergehäuses (2).

⇒ Das Akkufach wird sichtbar.

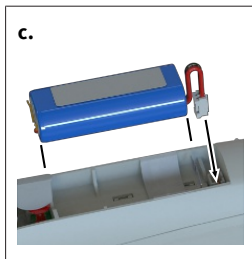

- c.** Stecker des Akkus am Kabel halten, entsprechend ausrichten und fest in die Buchse einstecken, bis er hörbar einrastet. Akku einlegen.

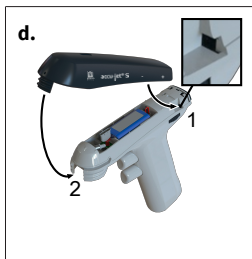

- d.** Gehäuse einsetzen. Dabei darauf achten, dass das Gehäuse in die vorgesehenen Aussparungen oberhalb des Einstellrads (1) und in die Verschraubung des Adaptergehäuses (2) eingreift.

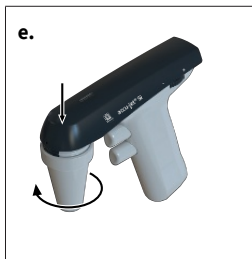

- e.** Gehäuseoberteil in die Gehäuseschalen drücken und Adaptergehäuse aufschrauben.

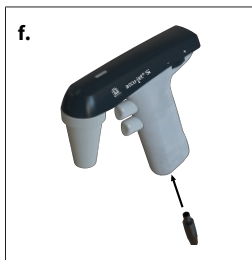

- f.** Akku laden, bis LED-Ladeindikator grün blinkt. Ladezeit ca. 4 Stunden, siehe Akku laden.

4.2 Akku laden

⚠️ WARNUNG



Beschädigtes Netzteil oder Ladekabel

Verletzungsgefahr durch Stromschlag.



> Beschädigtes Netzteil nicht verwenden.

> Ist das Ladekabel beschädigt, Netzteil nicht verwenden.

HINWEIS

Nur Original-Netzteil des Herstellers verwenden!

Der Gebrauch eines anderen Netzteils kann das Gerät sowie den Akku schädigen.

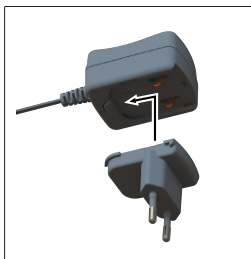

- a. Länderadapter auf Netzteil stecken.
 - b. Netzteil mit Gerät verbinden.
 - c. Netzteil in den Netzstecker stecken.
- ⇒ Das Gerät wird geladen. Dies ist erkennbar am LED-Ladeindikator auf dem Gehäuseoberteil. Zu Betriebsdauer und Ladedauer, siehe Technische Daten, S. 29 .

LED-Ladeindikator	Status	Was tun?
Grün: blinkend	Akku ist geladen. Erhaltungsladung wird durchgeführt.	Sie können mit dem Gerät arbeiten. Das Gerät ist vollständig geladen.
Grün: dauerhaft leuchtend	Akku lädt	Sie können auch während des Aufladens weiter arbeiten.
Rot: blinkend	Akku ist fast leer.	Unterbrechen Sie ihre Tätigkeit mit dem Gerät. Laden Sie den Akku auf. Sie können auch während des Aufladens weiter arbeiten.
Rot: dauerhaft leuchtend	Akku ist leer.	Laden Sie den Akku auf.

HINWEIS

- Die Erhaltungsladung verhindert das Überladen und minimiert den Lazy-Battery-Effekt. Um die maximale Kapazität zu erhalten, den Akku erst nachladen, wenn dies durch den LED-Ladeindikator angezeigt wird.
-

4.3 Gerät starten

Das Gerät ist betriebsbereit, wenn ein geladener Akku eingesetzt ist. Einen ON/OFF-Schalter gibt es nicht.

4.4 Betriebsart wählen

Wahlschalter, siehe Funktions- und Bedienelemente, S. 14 .

Betriebsart „Freier Ablauf“: Wahlschalter nach oben schieben.

Betriebsart „Ausblasen mit Motorunterstützung“: Wahlschalter nach unten schieben.

4.5 Flüssigkeit aufsaugen oder abgeben

Pipettierknopf, siehe Funktions- und Bedienelemente, S. 14

Zum Füllen der Pipette den oberen Pipettierknopf und zum Abgeben den unteren Pipettierknopf drücken.

4.6 Pipettiergeschwindigkeit verändern

Die Geschwindigkeit wird von der eingestellten maximalen Motordrehzahl begrenzt. Je weiter der obere oder untere Pipettierknopf eingedrückt wird, umso schneller wird Flüssigkeit aufgenommen oder abgegeben.

4.7 Motordrehzahl einstellen

Einstellrad, siehe Funktions- und Bedienelemente, S. 14

Die Motordrehzahl kann stufenlos von Maximum (+) bis Minimum (-) durch Drehen des Einstellrades eingestellt werden. Wir empfehlen die maximale Motordrehzahl für großvolumige Pipetten und eine geringere Motordrehzahl für kleinvolumige Pipetten.

4.8 Gerät aufbewahren

4.8.1 Tischablage

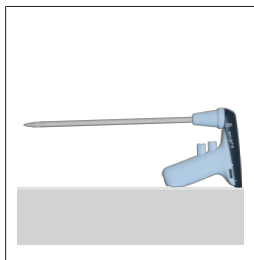

Der accu-jet® S kann auf ebener Fläche mit eingesteckter Pipette abgestellt werden.

4.8.2 Wandhalter



- a. Befestigungsoberfläche mit geeignetem Reinigungsmittel (keine rückfettenden Haushaltsreiniger) und fusselfreiem Tuch reinigen und gut trocknen lassen.
- b. Schutzfolie von Klebestreifen abziehen
- c. Wandhalter **fest** auf die Befestigungsoberfläche aufdrücken.

5 Pipettieren

1. Pipette aufstecken

⚠️ WARNUNG



Auf festen Sitz der Pipette achten. Nie Gewalt anwenden! Besonders bei dünnen Pipetten besteht die Gefahr von Glasbruch! Verletzungsgefahr!

1.



- a. Pipette stets möglichst dicht am oberen Ende halten und vorsichtig in den Adapter einschieben, bis sie fest sitzt.
- b. Gerät mit eingesteckter Pipette stets senkrecht halten, Spitze nach unten.

2. Pipette füllen

2.

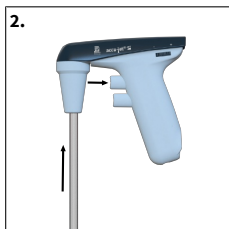

- a. Pipettenspitze in die Flüssigkeit eintauchen.
- b. Oberen Pipettierknopf langsam eindrücken und Pipette füllen, sodass der Meniskus etwas über den gewünschten Marken liegt.
- c. Werden beide Pipettierknöpfe gedrückt, können Sie Flüssigkeit sehr feinfühlig aufnehmen oder abgeben. Das ist besonders dann hilfreich,

wenn Sie den Meniskus einstellen oder aber Pipetten mit kleinen Volumina verwenden.

HINWEIS

Pipette nicht überfüllen.

3. Volumen einstellen

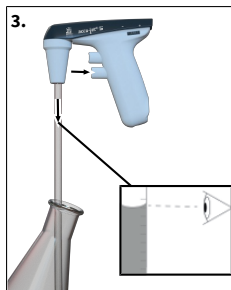

- a. Pipettenspitze ggf. mit geeignetem fusenfreiem Tuch abwischen.
- b. Unteren Pipettierknopf langsam eindrücken und Flüssigkeit ablassen, bis der Meniskus genau an der gewünschten Marke eingestellt ist.

4. Pipette entleeren

- a. Unteren Pipettierknopf langsam eindrücken. Die Pipettiergeschwindigkeit ist davon abhängig, wie weit die Pipettierknöpfe eingedrückt werden. In der Betriebsart „Ausblasen mit Motorunterstützung“ ist sie auch von der eingestellten Motordrehzahl abhängig.

5. Nach dem Pipettieren

- a. Pipette möglichst weit oben anfassen und aus dem Adapter herausziehen.

6 Reinigung

HINWEIS

accu-jet® S ist nicht autoklavierbar

Gehäuseteile gelegentlich mit einem feuchten Tuch abwischen. Bei ordnungsgemäßer Benutzung ist das Gerät wartungsfrei.

6.1 Dichtigkeit prüfen

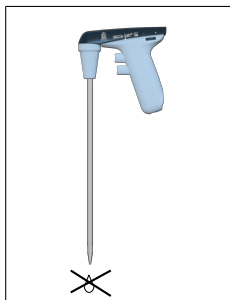

Nach dem Einstellen des Meniskus darf ohne Betätigung der Ventile keine Flüssigkeit aus der Pipette tropfen. Tropft die Pipette, siehe Störung - Was tun?

6.2 Filter austauschen und Adapter reinigen

⚠️ WARNUNG



Kontaminations- und Infektionsgefahr

Schutzhandschuhe und Augenschutz tragen.



HINWEIS

Ein Filtertausch oder die Reinigung ist nur notwendig, wenn eine Pipette überfüllt wurde oder die Saugleistung beeinträchtigt ist.

b.



- a.** Pipette herausziehen.
- b.** Adaptergehäuse abschrauben.
- c.** Obergehäuse abnehmen.

d.



- d.** Adapter und Membranfilter von der konisch zulaufenden Seite des Adaptergehäuses herausdrücken.

e.



- e.** Defekten Membranfilter abziehen.

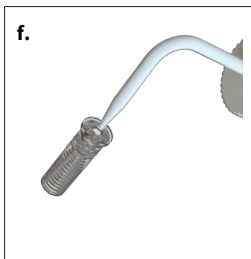

- f.** Zur Reinigung Adapter sorgfältig mit einer Spritzflasche ausspülen, die mit einer geeigneten Reinigungsflüssigkeit, z.B. Wasser, gefüllt ist. Anschließend ausblasen und trocknen.

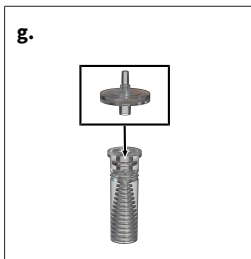

- g.** Neuen Membranfilter mit dem dickeren Anschluss nach unten zuerst in den Adapter eindrücken (die dünnere, konische Seite nach oben) und in das Adaptergehäuse einsetzen.

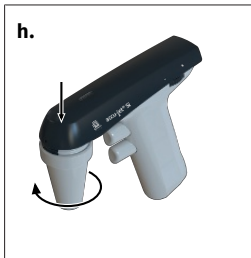

- h.** Gehäuseoberteil in die Gehäuseschalen drücken und Adaptergehäuse aufschrauben.

Hinweis zu autoklavierbaren Filtern

Die Wirksamkeit des Autoklavierens ist vom Anwender jeweils selbst zu prüfen. Nicht jeder Membranfilter ist geeignet! Nur Original-Zubehör verwenden.

- > Serienmäßig ist das Gerät mit 0,2 µm Membranfilter (roter Farbcode) ausgestattet.
 - > Der Membranfilter ist bis zu fünfmal bei 121 °C (250 °F) autoklavierbar.
 - > Mit 0,2 µm Membranfilter (für Zellkultur) können Volumentoleranzen der Klasse B erzielt werden.
 - > Zur Einhaltung der Volumentoleranzen der Klasse A sind 3 µm Membranfilter erforderlich. Diese haben aufgrund der größeren Porenweite einen geringeren Einfluss auf die freie Ablaufzeit der Pipetten, siehe Ersatzteile.
-

6.3 UV-Entkeimung

Das Gerät ist gegen die übliche Belastung einer UV-Entkeimungslampe beständig. Infolge der UV-Einwirkung ist eine Farbänderung möglich.

7 Störung - Was tun?





Störung	Ursache	Was tun?
Saugleistung beeinträchtigt	Motordrehzahl ist reduziert	Motordrehzahl erhöhen, siehe Motordrehzahl einstellen, S. 20 .
	Rückschlagventil geschlossen	Wahlschalter auf Ausblasen stellen und unteren Pipettierknopf drücken, siehe Betriebsart wählen, S. 19
Pipette tropft	Filter sitzt nicht richtig	Filter richtig einsetzen, siehe Filter austauschen und Adapter reinigen, S. 24 .
	Adapter oder Pipette beschädigt	Adapter bzw. Pipette austauschen, siehe Filter austauschen und Adapter reinigen, S. 24 .
Pipette hält nicht im Adapter	Adapter verschmutzt bzw. beschädigt	Adapter reinigen, lufttrocknen ggf. auswechseln, siehe Filter austauschen und Adapter reinigen, S. 24 .
LED-Ladeindikator leuchtet/blinkt nicht, nachdem das Netzteil angeschlossen ist und die Spannungsversorgung hergestellt wurde.	Akku-Stecker nicht fest eingesteckt	Akku-Stecker fest einstecken, siehe Akku anschließen, S. 16 .
	Falsches Netzteil	Nur Original-Netzteil verwenden, siehe Funktions- und Bedienelemente, S. 14
	Akku bzw. Netzteil defekt	Akku/Netzteil austauschen
	Gerät defekt	Gerät zur Reparatur einsenden, siehe Reparatur, S. 30
Geringe Akku-Kapazität	Akku defekt	Akku austauschen, siehe Akku anschließen, S. 16 .
Das Gerät zeigt keine Funktion	Interner Fehler (Reset durchführen)	Akku-Stecker lösen und einen Pipettierknopf 10 sec. lang gedrückt halten. Dann Akku-Stecker wieder fest einstecken, siehe Akku anschließen, S. 16 und Pipettieren, S. 22

Wenn Sie das Problem mittels obiger Störungstabelle nicht lösen können, wenden Sie sich an Ihren Fachhändler oder direkt an den Hersteller.

8 Technische Daten

Technische Daten	Werte
Ladebuchse	5 VDC
Netzteil	Input: 100 – 240 VAC, 50/60 Hz Output: 5 VDC
Akku	Akku-Pack NiMH 2,4 V, 730 mAh Ladezeit: 4 h Maximale Arbeitsdauer: ca. 8 h Ladetemperatur: +10 °C bis +35 °C

8.1 Kennzeichnung auf dem Produkt

Zeichen oder Nummer	Bedeutung
XXZXXXXX	Seriennummer
Quick Response Code	Enthält Seriennummer
	Mit diesem Zeichen bestätigen wir, dass das Produkt den in den EG-Richtlinien festgelegten Anforderungen entspricht und den festgelegten Prüfverfahren unterzogen wurde.
	UKCA: United Kingdom Conformity Assessed Mit diesem Zeichen bestätigen wir, dass das Produkt den in den UK Designated Standards festgelegten Anforderungen entspricht.
www.brand.de/ip	Patentinformationen
 (hier: 40 Jahre)	China RoHS (EFUP) EFUP definiert den Zeitraum in Jahren, in dem die in Elektro- und Elektronikgeräten enthaltenen gefährlichen Stoffe unter normalen Betriebsbedingungen nicht auslaufen oder sich verändern. Bei normalem Gebrauch durch den Benutzer führen solche Elektro- und Elektronikprodukte nicht zu einer schweren Umweltverschmutzung, zu schweren Körperverletzungen oder zur Beschädigung der Sachwerte des Benutzers.
	Das elektrische Gerät darf nicht mit dem Hausmüll entsorgt werden.

9 Reparatur

9.1 Zur Reparatur einsenden

HINWEIS

Der Transport von gefährlichem Material ohne Genehmigung ist gesetzlich verboten.

Gerät gründlich reinigen und dekontaminieren!

- Fügen Sie der Rücksendung von Produkten bitte grundsätzlich eine genaue Beschreibung der Art der Störung und der verwendeten Medien bei. Bei fehlender Angabe der verwendeten Medien kann das Gerät nicht repariert werden.
- Senden Sie das Gerät ausschließlich ohne Akku bzw. Batterie.
- Der Rücktransport geschieht auf Gefahr und Kosten des Einsenders.

Außerhalb der USA und Kanada

"Erklärung zur gesundheitlichen Unbedenklichkeit" ausfüllen und gemeinsam mit dem Gerät an Hersteller oder Händler senden. Vordrucke können beim Händler oder Hersteller angefordert werden, bzw. stehen unter www.brand.de zum Download bereit.

Innerhalb der USA und Kanada

Bitte klären Sie mit BrandTech Scientific, Inc. die Voraussetzungen für die Rücksendung **bevor** Sie das Gerät zum Service einschicken.

Senden Sie ausschließlich gereinigte und dekontaminierte Geräte an die Adresse, die Sie zusammen mit der Rücksendenummer erhalten haben. Die Rücksendenummer außen am Paket gut sichtbar anbringen.

Kontaktadressen

Deutschland:

BRAND GMBH + CO KG
Otto-Schott-Straße 25
97877 Wertheim (Germany)
T +49 9342 808 0
F +49 9342 808 98000
info@brand.de
www.brand.de

USA und Kanada:

BrandTech® Scientific, Inc.
11 Bokum Road
Essex, CT 06426-1506 (USA)
T +1-860-767 2562
F +1-860-767 2563
info@brandtech.com
www.brandtech.com

Indien:

BRAND Scientific Equipment Pvt. Ltd.
303, 3rd Floor, 'C' Wing, Delphi
Hiranandani Business Park,
Powai
Mumbai-400 076 (India)
T +91 22 42957790
F +91 22 42957791
info@brand.co.in
www.brand.co.in

China:

BRAND (Shanghai) Trading Co., Ltd.
Guangqi Culture Plaza
Room 506, Building B
No. 2899, Xietu Road
Shanghai 200030 (P.R. China)
T +86 21 6422 2318
F +86 21 6422 2268
info@brand.com.cn
www.brand.cn.com

10 Bestellinformationen

10.1 Gerät

Farbe des Gehäuseoberteils	Best.-Nr. (mit Universalnetzteil und Länderadapter)	Best.-Nr. (ohne Universalnetzteil und ohne Länderadapter)
Anthrazit	26350	26360
Beere	26351	26361
Petrol	26352	26362
Amethyst	26353	26363

Lieferumfang, siehe Lieferumfang. Beachten Sie die Bestellnummern, mit oder ohne Netzteil.

10.2 Ersatzteile

Ersatz-Membranfilter

Beschreibung	Verp.-Einh.	Best.-Nr.
0,2 µm, steril (roter Farbcode)	1 St. in Blisterverpackung	26530
0,2 µm	10 St. im PE-Beutel	26535
3 µm	1 St. in Blisterverpackung	26052
3 µm	10 St. im PE-Beutel	26056

Netzteil

Technische Daten zum Netzteil, siehe Technische Daten, S. 29 .

Typ	Best.-Nr.
Netzteil mit Länderadapter	26606

Akkupack

Technische Daten zum Akku, siehe Technische Daten, S. 29.

Beschreibung	Best.-Nr.
Akkupack NiMH	26630

Silikon-Adapter mit Rückschlagventil

Beschreibung	Best.-Nr.
Silikon-Adapter	26508

Adaptergehäuse

Farbe	Best.-Nr.
weiß	26658

Wandhalter

Farbe	Best.-Nr.
weiß	26539

Haftband

Verp. Einh.	Best.-Nr.
3 Sets	26547

11 Mängelhaftung

Wir haften nicht für Folgen unsachgemäßer Behandlung, Verwendung, Wartung, Bedienung oder nicht autorisierter Reparatur des Gerätes oder für Folgen normaler Abnutzung, insbesondere von Verschleißteilen wie z.B. Kolben, Dichtungen, Ventilen sowie bei Glasbruch. Gleiches gilt für die Nichtbeachtung der Gebrauchsanleitung. Insbesondere übernehmen wir keine Haftung für entstandene Schäden, wenn das Gerät weiter zerlegt wurde als in der Gebrauchsanleitung beschrieben oder wenn fremde Zubehör- bzw. Ersatzteile eingebaut wurden.

USA und Kanada:

Informationen zur Mängelhaftung finden Sie unter www.brandtech.com.

12 Entsorgung



Das nebenstehende Symbol bedeutet, dass Batterien/Akkus und elektronische Geräte am Ende ihrer Lebensdauer vom Hausmüll (unsortierter Siedlungsabfall) getrennt entsorgt werden müssen.

Elektronische Geräte müssen gemäß der Richtlinie 2012/19/EU des europäischen Parlaments und des Rates vom 04. Juli 2012 über Elektro- und Elektronik-Altgeräte fachgerecht entsprechend den nationalen Entsorgungsvorschriften entsorgt werden.

Batterien und Akkus enthalten Stoffe, die sich schädlich auf die Umwelt und die menschliche Gesundheit auswirken können. Sie müssen daher gemäß der Richtlinie 2006/66/EG des europäischen Parlaments und des Rates vom 06. September 2006 über Batterien und Akkumulatoren fachgerecht entsprechend den nationalen Entsorgungsvorschriften entsorgt werden. Nur vollständig entladene Batterien und Akkus entsorgen.

EU-Konformitätserklärung | EU Declaration of Conformity

Produktbezeichnung: Product name:	Pipettierhelfer accu-jet® S / Pipetting controller accu-jet® S
Produktvarianten: Product variations:	Anthrazit, Beere, Petrol, Amethyst / anthracite, berry, petrol, amethyst
Art-Nr. / Cat.-No.	26350, 26351, 26352, 26353, 26360, 26361, 26362, 26363

Das oben beschriebene Produkt entspricht den grundlegenden Anforderungen, die in den nachfolgend bezeichneten Harmonisierungsrechtsvorschriften festgelegt sind: The product described above meets the basic requirements that are specified in the harmonization legislation listed below:	Angewendete harmonisierte Normen: Applied harmonized standards:
RoHS: 2011/65/EU incl.2015/863/EU EMC: 2014/30/EU	EN IEC 63000:2018 EN 61326-1:2013
Weitere angewendete Normen: Other applied standards:	Geltungsbereich: Scope:
EN 61010-1:2010, EN 61010-1:2010/A1:2019/AC:2019-04 EN/IEC 62368-1:2014 (angewendet auf Fremdherstellernetzteil / applied to third-party power supply)	NRL / LVD NRL / LVD

Die alleinige Verantwortung für die Ausstellung dieser Konformitätserklärung in Bezug auf die Erfüllung der grundlegenden Anforderungen und die Anfertigung der technischen Unterlagen trägt der Hersteller.

The manufacturer is solely responsible for issuing this declaration of conformity with regard to meeting the essential requirements and preparing the technical documentation.

Hersteller / Manufacturer	Adresse / Address
BRAND GMBH + CO KG	Otto-Schott-Str. 25 97877 Wertheim Germany

Wertheim, 01. Juli 2022 / 01 July 2022



Patrick Ziemeck
Managing Director Technology



i.A. Siegfried Ott
Regulatory Affairs

Diese Erklärung bescheinigt die Übereinstimmung mit den genannten Harmonisierungsvorschriften, beinhaltet jedoch keine Zusicherung von Eigenschaften.

This document declares the accordance with the named harmonized regulations, but does not assure specific properties.

UK Declaration of Conformity

Product name: Pipetting controller accu-jet® S
Product variations: anthracite, berry, petrol, amethyst
Cat.-No. 26350, 26351, 26352, 26353, 26360, 26361, 26362, 26363

The product described above meets the basic requirements that are specified in the harmonization legislation listed below:	Applied harmonized standards:
The Restriction of the Use of Certain Hazardous Substances in Electrical and Electronic Equipment Regulations 2012 (SI 2012 No. 3032)	EN IEC 63000:2018
Electromagnetic Compatibility Regulations 2016 (SI 2016 No. 1091, as amended by SI 2019 No. 696)	EN 61326-1:2013
Other applied standards:	Scope:
EN 61010-1:2010, EN 61010-1:2010/A1:2019/AC:2019-04 EN/IEC 62368-1:2014 (angewendet auf Fremdherstellernetzteil / applied to third-party power supply)	LVD LVD

The manufacturer is solely responsible for issuing this declaration of conformity with regard to meeting the essential requirements and preparing the technical documentation.

Manufacturer	Address
BRAND GMBH + CO KG	Otto-Schott-Str. 25 97877 Wertheim Germany

Wertheim, 18 February 2022



Patrick Ziemeck
Managing Director Technology



i.A. Siegfried Ott
Regulatory Affairs

This document declares the accordance with the named harmonized regulations, but does not assure specific properties.

Declaration of conformity – China RoHS 2

BRAND GMBH + CO KG has made reasonable efforts to ensure that hazardous materials and substances may not be used in BRAND products.

In order to determine the concentration of hazardous substances in all homogeneous materials of the subassemblies, a “Product Conformity Assessment” (PCA) procedure was performed. As defined in GB/T 26572 the “Maximum Concentration Value” limits (MCV) apply to these restricted substances:

+ Lead (Pb):	0.1%	+ Hexavalent chromium (Cr(+VI)):	0.1%
+ Mercury (Hg):	0.1%	+ Polybrominated biphenyls (PBB):	0.1%
+ Cadmium (Cd):	0.01%	+ Polybrominated diphenyl ether (PBDE):	0.1%

Environmental Friendly Use Period (EFUP)

EFUP defines the period in years during which the hazardous substances contained in electrical and electronic products will not leak or mutate under normal operating conditions. During normal use by the user such electrical and electronic products will not result in serious environmental pollution, cause serious bodily injury or damage to the user's assets.

The Environmental Friendly Use Period for BRAND instruments is 40 years.



Material Content Declaration for BRAND Products

部件名称 Part name	有毒有害物质或元素 Hazardous substances					
	铅 Pb	汞 Hg	镉 Cd	六价铬 Cr(+VI)	多溴联苯 PBB	多溴二苯醚 PBDE
包装 / Packaging	0	0	0	0	0	0
塑料外壳 / 组件 Plastic housing / parts	0	0	0	0	0	0
电池 / Battery	0	0	0	0	0	0
玻璃 / Glass	0	0	0	0	0	0
电子电气组件 Electrical and electronic parts	X	0	0	0	0	0
金属外壳 / 组件 Metal housing / parts	X	0	0	0	0	0
电机 / Motor	X	0	0	0	0	0
配件 / Accessories	X	0	0	0	0	0

此表格是按照SJ/T 11364-2014中规定所制定的。

This table is created according to SJ/T 11364-2014.

- O: 表示该有毒有害物质在该部件所有均质材料中的含量均在GB/T 26572规定的限量要求以下。
O: Indicates that the above mentioned hazardous substance contained in all homogeneous materials of the part is below the required limit as defined in GB/T 26572.
- X: 表示该有毒有害物质至少在该部件某一均质材料中的含量超出GB/T 26572规定的限量要求。
X: Indicates that the above mentioned hazardous substance contained in at least one of the homogeneous materials of this part is above the required limit as defined in GB/T 26572.

注释： 电池，玻璃制品和配件可能不属于此设备的一部分且/或可能有它自己的EFUP标志且/或可能包含更改EFUP标志的部件。

Note: Batteries, glassware and accessories might not be content of the enclosed device and/or may have their own EFUP-marking and/or might be maintaining parts with changing EFUP-marking.

除上表所示信息外，还需声明的是，这些部件并非是有用铅 (Pb), 汞 (Hg), 镉 (Cd), 六价铬 (Cr(+VI)), 多溴联苯 (PBB) 或多溴二苯醚 (PBDE) 来制造的。

Apart from the disclosures in the above table, the subassemblies are not intentionally manufactured or formulated with lead (Pb), mercury (Hg), cadmium (Cd), hexavalent chromium (Cr+VI), polybrominated biphenyls (PBB), and polybrominated diphenyl ethers (PBDE).

Products manufactured by BRAND may enter into further devices or can be used together with other appliances. With these third party products and appliances in particular, please note the EFUP labeled on these products. BRAND will not take responsibility for the EFUP of those products and appliances.

Place, date: Wertheim, 05|04|2022



Patrick Ziemeck
(Managing Director Technology)



i.A. Siegfried Ott
(Regulatory Affairs)

Table of contents

1	Introduction	42
1.1	Scope of delivery	42
1.2	Terms of use	42
2	Safety	44
2.1	Function	45
2.2	Limitations of use	45
2.3	Operating exclusions	45
2.4	Storage Conditions	46
3	Functional and operating elements	47
4	Assembly	49
4.1	Connecting the battery	49
4.2	Charging the battery	51
4.3	Turning on the instrument	52
4.4	Selecting the operating mode	52
4.5	Aspirating or dispensing liquid	52
4.6	Changing the pipetting speed	53
4.7	Setting the motor speed	53
4.8	Storing the instrument	53
5	Pipetting	55
6	Cleaning	57
6.1	Check tightness	57
6.2	Replace filter and clean adapter	57
6.3	UV sterilization	60
7	Troubleshooting	61
8	Technical data	62
8.1	Product markings	62
9	Repairs	63
9.1	Sending for repair	63

10 Ordering Information.....	65
10.1 Instrument.....	65
10.2 Spare parts	65
11 Warranty	67
12 Disposal.....	68

1 Introduction

1.1 Scope of delivery

Pipette controller, nickel-metal hydride battery, optional power adapter (note different order numbers), 2 spare 0.2 µm membrane filters, wall mount, operating manual.

1.2 Terms of use





- Carefully read the operating manual before using the device for the first time.
- The operating manual is part of the device and must be kept in an easily accessible place.
- Be sure to include the operating manual if you transfer possession of this device to a third party.

1.2.1 Hazard levels

The following signal words identify possible hazards:

Signal word	Meaning
DANGER	Will lead to serious injury or death.
WARNING	May lead to serious injury or death.
CAUTION	May lead to minor or moderate injuries.
NOTICE	May lead to property damage.

1.2.2 Operating manual symbols

Symbol	Meaning	Symbol	Meaning
	Hazardous area		Explosion hazard
	Wear eye protection		Wear protective gloves

1.2.3 Format

Format	Meaning	Format	Meaning
1. Task	Indicates a task.	>	Indicates a condition.
a., b., c.	Indicates the individual steps of a task.	⇒	Indicates a result.

2 Safety

Please read carefully!

The instrument accu-jet® S can be used in combination with hazardous materials, work processes and equipment. However, the operating manual cannot cover all of the safety issues that may occur in doing so. It is the user's responsibility to ensure compliance with the safety and health regulations and to specify the corresponding restrictions before use.

1. Every user must read and understand this operating manual before operation.
2. Follow the general hazard instructions and safety regulations (e.g., wear protective clothing, eye protection, and protective gloves).
3. Observe all specifications provided by reagent manufacturers.
4. Do not operate the instrument in potentially explosive atmospheres and do not pipette highly flammable media.
5. Use the instrument only for pipetting liquids and only within the defined limits of use. Comply with the operating exclusions; see Operating exclusions, p. 45 ! If in doubt, contact the manufacturer or supplier.
6. Always perform work in a manner that does not endanger yourself or other people. Avoid splattering. Only use suitable vessels.
7. Never use force.
8. Use only original accessories and replacement parts. Do not make any technical modifications. Do not dismantle the instrument any further than is described in the operating manual!
9. Always check that the instrument is in proper working condition before use. If an instrument fault is signaled, stop pipetting immediately and follow the instructions in the section Störung - Was tun?. Contact the manufacturer, if necessary.
10. Use only the original power adapter to charge the nickel-metal hydride battery.
11. Do not use batteries from other manufacturers.

12. Protect the power adapter from moisture and use it only with this instrument.
13. Stop using the power adapter if the connection cable is damaged.
14. Only authorized service technicians are permitted to carry out repairs and internal maintenance on the instrument.

2.1 Function

The device serves as an aid for pipetting liquids with graduated and volumetric pipettes made of glass or plastic in the volume range from 0.1 ml to 200 ml and with a suction tube outer diameter < 9.2 mm. When the device is handled correctly, the pipetted liquid comes into contact with the pipette only.

2.2 Limitations of use

This device is intended for pipetting liquids within the following physical limitations:

- from 10 to 40°C (from 50 to 104°F) (device and reagent)
- vapor pressure up to 500 mbar. Absorb slowly above 300 mbar in order to prevent the liquid from boiling.
- Density up to 9 g/cm³

2.3 Operating exclusions

The instrument must not be used for liquids with vapors that can cause corrosion or attack the materials silicone or EPDM.

The instrument is not suitable for use with Pasteur pipettes.

⚠ WARNING



Operating the instrument in a potentially explosive atmosphere

The instrument must never be operated or charged in a potentially explosive atmosphere. Pipetting highly flammable media (flash point under 0 °C (32 °F), e.g. ether, acetone) is prohibited.

2.4 Storage Conditions

Store the unit and accessories in a cool and dry place in cleaned condition only.

Storage temperature from -20 to 50°C (-4 to 122°F).

Relative humidity: 5 % to 95 %.

3 Functional and operating elements

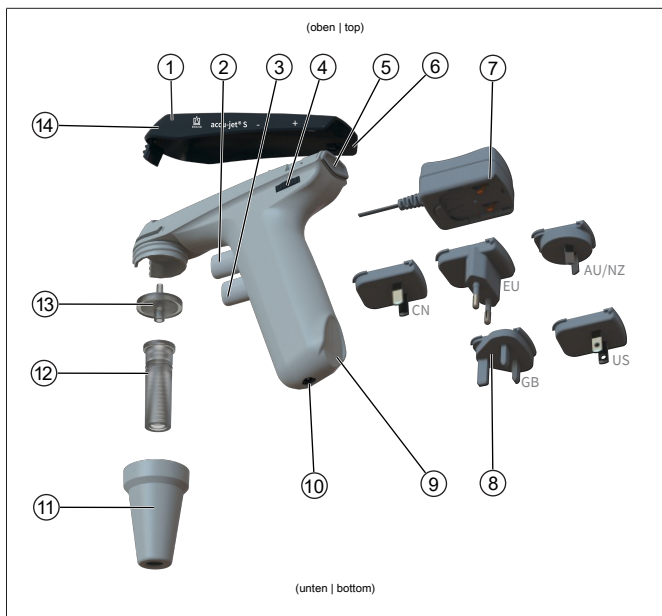

- | | |
|---|--|
| 1 Upper housing shell | 2 Upper pipetting button (aspirate liquid) |
| 3 Bottom pipetting button (dispense liquid) | 4 Motor speed adjustment wheel |
| 5 Operating mode selection switch | 6 Upper housing shell base |
| 7 Power adapter | 8 Country adapter |
| 9 Handle base | 10 Charging socket |
| 11 Adapter housing (PP) | 12 Adapter/non-return valve (SI/PTFE) |
| 13 Membrane filter (PP/PTFE) | 14 Pressure compensation opening |

For voltage and current consumption specifications, see Technical data, p. 62 .

3 Functional and operating elements

Abbrevia- tion	Material
PP	Polypropylene
PTFE	Polytetrafluoroethylene
SI	Silicone

4 Assembly

4.1 Connecting the battery

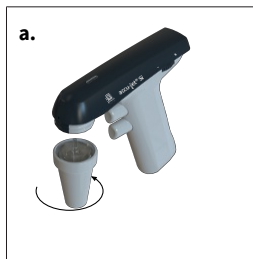

- a.** Unscrew the adapter housing. Adapter and filter remain in the adapter housing.

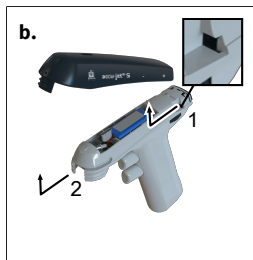

- b.** Remove housing. Lightly push the housing towards the screw connection of the adapter housing.
- ⇒ The housing disengages from the slots above the adjustment wheel (1) and from the screw connection of the adapter housing (2).
 - ⇒ The battery compartment becomes visible.

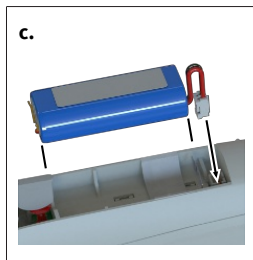

- c.** Grip battery plug by the wire, confirm alignment of the plug and insert it into the socket. Push it firmly into the socket until you can hear it snap into place. Insert the battery into the compartment.

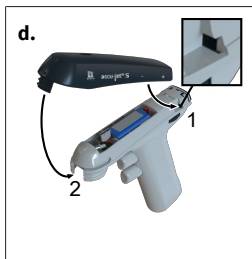

- d.** Insert housing. While doing so, make sure that the housing engages in the designated slots above the adjustment wheel (1) and in the screw connection of the adapter housing (2).

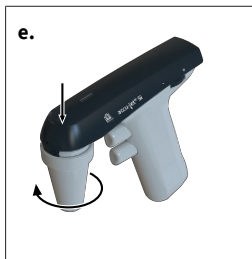

- e.** Press the upper housing section into the housing shells and screw on the adapter housing.

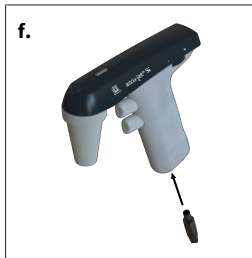

- f.** Charge the battery until the LED charge indicator is flashing green. Charging time is approx. 4 hours, see Charging the battery.

4.2 Charging the battery

⚠ WARNING



Damaged power adapter or charging cable

Risk of injury due to electric shock.



- > Do not use a damaged power adapter.
- > If the charging cable is damaged, do not use the power adapter.

NOTICE

Use only the original power adapter supplied by the manufacturer!

Using another power adapter can damage the instrument and the battery.

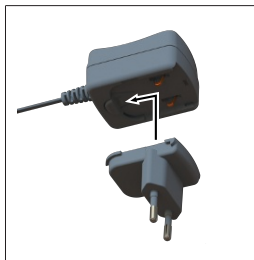

- a. Place the country adapter onto the power adapter.
 - b. Connect the power adapter to the instrument.
 - c. Plug the power adapter into the power outlet.
- ⇒ The instrument is charging. This is indicated by the LED charge indicator on the upper housing section. For operation and charging duration, see Technical data, p. 62 .

LED charge indicator	Status	Corrective action
Green: blinking	Battery is charged. Trickle charging is carried out.	You can work with the instrument. The instrument is fully charged.
Green: permanently lit	Battery is charging	You can also continue to work while charging.
Red: blinking	Battery is almost empty.	Interrupt your work with the instrument. Charge the battery.

LED charge indicator	Status	Corrective action
		You can also continue to work while charging.
Red: permanently lit	Battery is empty.	Charge the battery.

NOTICE

- Trickle charging prevents overcharging and minimizes the lazy battery effect. To maintain maximum capacity, only recharge the battery when the LED charge indicator lights up.

4.3 Turning on the instrument

The instrument is ready for operation when a charged battery is inserted. There is no ON/OFF switch.

4.4 Selecting the operating mode

Selection switch, see Functional and operating elements, p. 47 .

“Gravity delivery” operating mode: slide the selection switch upward.

“Blow-out with motor support” operating mode: slide the selection switch downward.

4.5 Aspirating or dispensing liquid

Pipetting button, see Functional and operating elements, p. 47

To fill the pipette, press the upper pipetting button; to dispense, press the lower pipetting button.

4.6 Changing the pipetting speed

The speed is limited by the maximum motor speed set. The further the upper and lower pipetting buttons are pressed in, the faster the instrument aspirates or dispenses liquid.

4.7 Setting the motor speed

Adjustment wheel, see Functional and operating elements, p. 47

The motor speed can be infinitely adjusted from maximum (+) to minimum (-) by turning the adjustment wheel. We recommend using the maximum motor speed for large volume pipettes and a lower motor speed for small volume pipettes.

4.8 Storing the instrument

4.8.1 Table placement

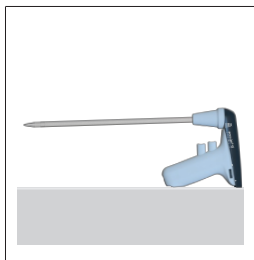

The accu-jet® S can be set down on an even surface with an inserted pipette.

4.8.2 Wall mount



- a. Clean the mounting surface with a suitable cleaner (no moisturizing household cleaners) and a lint-free cloth, and allow it to dry thoroughly.
- b. Remove the protective film from the adhesive strips.
- c. **Firmly** press the wall mount onto the mounting surface.

5 Pipetting

1. Attaching the pipette

⚠ WARNING



Ensure that the pipette is firmly in place. Never use force! Especially with thin pipettes, there is a risk of glass breakage!
Risk of injury!

1.



- a. Always hold the pipette as close as possible to the upper end and push it carefully into the adapter until it is firmly in place.
- b. Always hold the instrument with the pipette inserted vertically, tip down.

2. Filling the pipette

2.

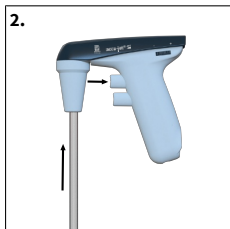

- a. Immerse pipette tip into the test liquid.
- b. Press the upper pipetting button slowly and fill the pipette so that the meniscus lies slightly above the desired marks.
- c. You can aspirate or dispense liquid with greater precision by pressing both pipetting buttons. This is particularly helpful when adjusting the meniscus or when using small volume pipettes.

NOTICE

Do not overfill the pipette.

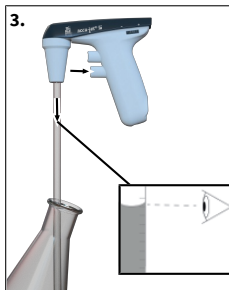
3. Setting the volume

- a.** If necessary, wipe the tip of the pipette with a suitable lint-free cloth.
- b.** Press the lower pipetting button slowly and dispense liquid until the meniscus is adjusted exactly to the desired volume.

4. Emptying the pipette

- a.** Press the lower pipetting button slowly. The pipetting speed depends on how far the pipetting buttons have been pressed in. In the “Blow-out with motor support” operating mode, the speed also depends on the set motor speed.

5. After pipetting

- a.** Grip the pipette as high up as possible, and pull it out of the adapter.

6 Cleaning

NOTICE

accu-jet® S is not autoclavable

Occasionally clean the housing parts with a damp cloth. When used properly, the instrument is maintenance-free.

6.1 Check tightness

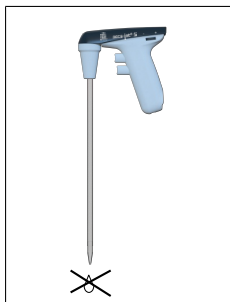

After adjusting the meniscus, no liquid should drip from the pipette without operating the valves. If the pipette is dripping, see Troubleshooting

6.2 Replace filter and clean adapter

⚠ WARNING



Risk of contamination and infection

Wear protective gloves and goggles.



NOTICE

Filter replacement or cleaning is only necessary if a pipette has been overfilled or the suction capacity is impaired.

b.

- a.** Pull out pipette.
- b.** Unscrew the adapter housing.
- c.** Pull out the upper housing.

d.

- d.** Push out the adapter and membrane filter from the tapered side of the adapter housing.

e.

- e.** Remove defective membrane filter.

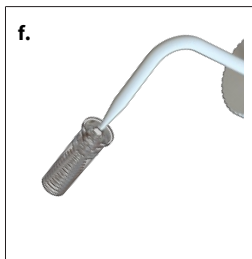

- f.** For cleaning, rinse the adapter carefully with a spray bottle filled with a suitable cleaning liquid (e.g., water). Then blow out and dry.

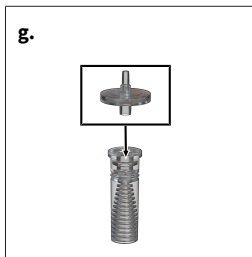

- g.** First press the new membrane filter into the adapter with the thicker connection facing downwards (the thinner, conical side facing upwards) and insert it into the adapter housing.

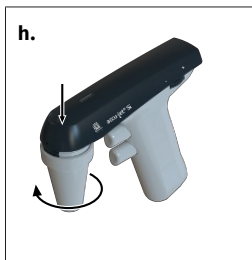

- h.** Press the upper housing section into the housing shells and screw on the adapter housing.

NOTICE**Information on autoclavable filters**

It is the user's responsibility to ensure effective autoclaving. Not every membrane filter is suitable! Use only original accessories.

- > The instrument comes equipped with a 0.2 μm membrane filter (red color code).
 - > The membrane filter can be autoclaved up to five times at 121°C (250 °F).
 - > Class B volume tolerances can be achieved with 0.2 μm membrane filters (for cell cultures).
 - > 3 μm membrane filters are required to comply with Class A volume tolerances. Due to the larger pore size, these have a reduced impact on the free delivery time of the pipettes, see .
-

6.3 UV sterilization

The device is resistant to normal exposure to a UV disinfection lamp. The effects of the UV exposure may cause some color change.

7 Troubleshooting





Problem	Cause	Corrective action
Suction capacity impaired	Motor speed is reduced	Increase motor speed, see Setting the motor speed, p. 53 .
	Non-return valve closed	Set the selection to “Blow-out” and press the lower pipetting button, see Selecting the operating mode, p. 52
Pipette dripping	Filter not properly positioned	Insert filter correctly, see Replacing the filter and cleaning the adapter, p. 57 .
	Adapter or pipette damaged	Replace the adapter or pipette, see Replacing the filter and cleaning the adapter, p. 57 .
Pipette not held in adapter	Adapter dirty or damaged	Clean adapter, allow to air dry or replace if necessary, see Replacing the filter and cleaning the adapter, p. 57 .
LED charge indicator does not light up/blink after the power adapter is connected and power is supplied.	Battery plug not firmly inserted	Firmly insert the battery plug, see Connecting the battery, p. 49 .
	Wrong power adapter	Use only the original power adapter, see Functional and operating elements, p. 47
	Battery or power adapter defective	Replace battery/power adapter
	Instrument defective	Send instrument in for repair, see Repairs, p. 63
Low battery capacity	Battery defective	Replace the battery, see Connecting the battery, p. 49 .
The instrument does not show any function	Internal error (perform reset)	Remove the battery plug and hold a pipetting button for 10 seconds. Then firmly insert the battery plug again, see Connecting the battery, p. 49 and Pipetting, p. 55

If the troubleshooting table above does not solve the problem, contact your authorized dealer or the manufacturer directly.

8 Technical data

Technical data	Values
Charging socket	5 VDC
Power adapter	Input: 100 – 240 VAC, 50/60 Hz Output: 5 VDC
Battery	Battery pack NiMH 2.4 V, 730 mAh Charging time: 4 h Maximum operating time: approx. 8 h Charging temperature: +10 °C to +35 °C

8.1 Product markings

Symbol or number	Meaning
XXZXXXXX	Serial number
Quick Response Code	Contains serial number
	With this mark, we confirm that the product complies with the requirements set out in the EC Directives and has been subjected to the specified testing procedures.
	UKCA: United Kingdom Conformity Assessed With this mark, we confirm that the product complies with the requirements set out in the UK Designated Standards.
www.brand.de/ip	Patent information
 (Here: 40 years)	China RoHS (EFUP) EFUP defines the time period in years, in which the hazardous materials found in the electrical and electronic equipment should not leak or change under normal operating conditions. When used under normal conditions, such electrical or electronic products do not lead to severe environmental pollution, severe personal injuries or damage to the user's property.
	This electrical instrument may not be disposed of in household waste.

9 Repairs

9.1 Sending for repair

NOTICE

Transporting of hazardous materials without a permit is a violation of federal law.

Clean the instrument thoroughly and decontaminate!

- When returning products, please enclose a general description of the type of malfunction and the media used. If information regarding media used is missing, the instrument cannot be repaired.
- Only send the device without a battery installed.
- Shipment is at the risk and the cost of the sender.

Outside USA and Canada

Complete the “Declaration on Absence of Health Hazards” and send the instrument to the manufacturer or supplier. Ask your supplier or manufacturer for the form. The form can also be downloaded from www.brand.de.

Within USA and Canada

Please clarify the requirements for the return delivery with BrandTech Scientific, Inc **before** sending the instrument in for service.

Return only cleaned and decontaminated instruments to the address provided with the Return Authorization Number. Place the Return Authorization number so that it is clearly visible on the outside of the package.

Contact addresses

Germany:

BRAND GMBH + CO KG
Otto-Schott-Str. 25
97877 Wertheim (Germany)
T +49 9342 808 0
F +49 9342 808 98000
info@brand.de
www.brand.de

USA and Canada:

BrandTech® Scientific, Inc.
11 Bokum Road
Essex, CT 06426-1506 (USA)
T +1-860-767 2562
F +1-860-767 2563
info@brandtech.com
www.brandtech.com

India:

BRAND Scientific Equipment Pvt. Ltd.
303, 3rd Floor, 'C' Wing, Delphi
Hiranandani Business Park,
Powai
Mumbai-400 076 (India)
T +91 22 42957790
F +91 22 42957791
info@brand.co.in
www.brand.co.in

China:

BRAND (Shanghai) Trading Co., Ltd.
Guangqi Culture Plaza
Room 506, Building B
No. 2899, Xietu Road
Shanghai 200030 (P.R. China)
T +86 21 6422 2318
F +86 21 6422 2268
info@brand.com.cn
www.brand.cn.com

10 Ordering Information

10.1 Instrument

Color of the upper housing section	Order no. (with universal power adapter and country adapter)	Order no. (without universal power adapter and without country adapter)
Anthracite	26350	26360
Berry	26351	26361
Petrol	26352	26362
Amethyst	26353	26363

Scope of delivery, see . Note the order numbers, with or without power adapter.

10.2 Spare parts

Replacement membrane filter

Description	Packing unit	Order No.
0.2 µm, sterile (red color code)	1 pc in blister packaging	26530
0.2 µm	10 pcs in PE bag	26535
3 µm	1 pc in blister packaging	26052
3 µm	10 pcs in PE bag	26056

Power adapter

Technical specifications for power adapter, see Technical data, p. 62 .

Type	Order No.
Power adapter and country adapter	26606

Battery pack

Technical specifications for battery, see Technical data, p. 62 .

Description	Order No.
Battery pack NiMH	26630

Silicone adapter with non-return valve

Description	Order No.
Silicone adapter	26508

Adapter housing

Color	Order No.
white	26658

Wall mount

Color	Order No.
white	26539

Snap tape

Packaging unit	Order No.
3 sets	26547

11 Warranty

We shall not be liable for the consequences of improper handling, use, servicing, operating or unauthorized repairs of the device or for the consequences of normal wear and tear, especially of wearing parts such as pistons, seals, valves and the breakage of glass. The same applies for failure to follow the instructions of the operating manual. We are not liable for damage resulting from disassembly beyond that described in the operating manual or if non-original spare parts or components have been installed.

USA and Canada:

Find more warranty information on www.brandtech.com.

12 Disposal



This symbol means that at the end of their service life, batteries/accumulators and electronic devices must be disposed of separately from household waste (unsorted municipal waste).

Electronic devices must be disposed of in accordance with Directive 2012/19/ EU of the European Parliament and of the Council from July 04, 2012 on waste from electrical and electronic equipment and in compliance with national disposal regulations.

Both batteries and accumulators (rechargeable batteries) contain materials that can be damaging to the environment and human health. Therefore, they must be properly disposed of in accordance with Directive 2006/66/EC of the European Parliament and of the Council from September 06, 2006 on batteries and accumulators and in compliance with national disposal regulations. Only dispose of fully discharged batteries and accumulators.

EU-Konformitätserklärung | EU Declaration of Conformity

Produktbezeichnung: Product name:	Pipettierhelfer accu-jet® S / Pipetting controller accu-jet® S
Produktvarianten: Product variations:	Anthrazit, Beere, Petrol, Amethyst / anthracite, berry, petrol, amethyst
Art.-Nr. / Cat.-No.	26350, 26351, 26352, 26353, 26360, 26361, 26362, 26363

Das oben beschriebene Produkt entspricht den grundlegenden Anforderungen, die in den nachfolgend bezeichneten Harmonisierungsrechtsvorschriften festgelegt sind: The product described above meets the basic requirements that are specified in the harmonization legislation listed below:	Angewendete harmonisierte Normen: Applied harmonized standards:
RoHS: 2011/65/EU incl.2015/863/EU EMC: 2014/30/EU	EN IEC 63000:2018 EN 61326-1:2013
Weitere angewendete Normen: Other applied standards:	Geltungsbereich: Scope:
EN 61010-1:2010, EN 61010-1:2010/A1:2019/AC:2019-04 EN/IEC 62368-1:2014 (angewendet auf Fremdherstellernetzteil / applied to third-party power supply)	NRL / LVD NRL / LVD

Die alleinige Verantwortung für die Ausstellung dieser Konformitätserklärung in Bezug auf die Erfüllung der grundlegenden Anforderungen und die Anfertigung der technischen Unterlagen trägt der Hersteller.

The manufacturer is solely responsible for issuing this declaration of conformity with regard to meeting the essential requirements and preparing the technical documentation.

Hersteller / Manufacturer	Adresse / Address
BRAND GMBH + CO KG	Otto-Schott-Str. 25 97877 Wertheim Germany

Wertheim, 01. Juli 2022 / 01 July 2022



Patrick Ziemeck
Managing Director Technology



i.A. Siegfried Ott
Regulatory Affairs

Diese Erklärung bescheinigt die Übereinstimmung mit den genannten Harmonisierungsvorschriften, beinhaltet jedoch keine Zusicherung von Eigenschaften.

This document declares the accordance with the named harmonized regulations, but does not assure specific properties.

UK Declaration of Conformity

Product name: Pipetting controller accu-jet® S
Product variations: anthracite, berry, petrol, amethyst
Cat.-No. 26350, 26351, 26352, 26353, 26360, 26361, 26362, 26363

The product described above meets the basic requirements that are specified in the harmonization legislation listed below:	Applied harmonized standards:
The Restriction of the Use of Certain Hazardous Substances in Electrical and Electronic Equipment Regulations 2012 (SI 2012 No. 3032)	EN IEC 63000:2018
Electromagnetic Compatibility Regulations 2016 (SI 2016 No. 1091, as amended by SI 2019 No. 696)	EN 61326-1:2013
Other applied standards:	Scope:
EN 61010-1:2010, EN 61010-1:2010/A1:2019/AC:2019-04 EN/IEC 62368-1:2014 (angewendet auf Fremdherstellernetzteil / applied to third-party power supply)	LVD LVD

The manufacturer is solely responsible for issuing this declaration of conformity with regard to meeting the essential requirements and preparing the technical documentation.

Manufacturer	Address
BRAND GMBH + CO KG	Otto-Schott-Str. 25 97877 Wertheim Germany

Wertheim, 18 February 2022



Patrick Ziemeck
Managing Director Technology



i.A. Siegfried Ott
Regulatory Affairs

This document declares the accordance with the named harmonized regulations, but does not assure specific properties.

Declaration of conformity – China RoHS 2

BRAND GMBH + CO KG has made reasonable efforts to ensure that hazardous materials and substances may not be used in BRAND products.

In order to determine the concentration of hazardous substances in all homogeneous materials of the subassemblies, a “Product Conformity Assessment” (PCA) procedure was performed. As defined in GB/T 26572 the “Maximum Concentration Value” limits (MCV) apply to these restricted substances:

+ Lead (Pb):	0.1%	+ Hexavalent chromium (Cr(+VI)):	0.1%
+ Mercury (Hg):	0.1%	+ Polybrominated biphenyls (PBB):	0.1%
+ Cadmium (Cd):	0.01%	+ Polybrominated diphenyl ether (PBDE):	0.1%

Environmental Friendly Use Period (EFUP)

EFUP defines the period in years during which the hazardous substances contained in electrical and electronic products will not leak or mutate under normal operating conditions. During normal use by the user such electrical and electronic products will not result in serious environmental pollution, cause serious bodily injury or damage to the user's assets.

The Environmental Friendly Use Period for BRAND instruments is 40 years.



Material Content Declaration for BRAND Products

部件名称 Part name	有毒有害物质或元素 Hazardous substances					
	铅 Pb	汞 Hg	镉 Cd	六价铬 Cr(+VI)	多溴联苯 PBB	多溴二苯醚 PBDE
包装 / Packaging	0	0	0	0	0	0
塑料外壳 / 组件 Plastic housing / parts	0	0	0	0	0	0
电池 / Battery	0	0	0	0	0	0
玻璃 / Glass	0	0	0	0	0	0
电子电气组件 Electrical and electronic parts	X	0	0	0	0	0
金属外壳 / 组件 Metal housing / parts	X	0	0	0	0	0
电机 / Motor	X	0	0	0	0	0
配件 / Accessories	X	0	0	0	0	0
此表格是按照SJ/T 11364-2014中规定所制定的。 This table is created according to SJ/T 11364-2014.						

- O: 表示该有毒有害物质在该部件所有均质材料中的含量均在GB/T 26572规定的限量要求以下。
O: Indicates that the above mentioned hazardous substance contained in all homogeneous materials of the part is below the required limit as defined in GB/T 26572.
- X: 表示该有毒有害物质至少在该部件某一均质材料中的含量超出GB/T 26572规定的限量要求。
X: Indicates that the above mentioned hazardous substance contained in at least one of the homogeneous materials of this part is above the required limit as defined in GB/T 26572.

注释： 电池，玻璃制品和配件可能不属于此设备的一部分且/或可能有它自己的EFUP标志且/或可能包含更改EFUP标志的部件。

Note: Batteries, glassware and accessories might not be content of the enclosed device and/or may have their own EFUP-marking and/or might be maintaining parts with changing EFUP-marking.

除上表所示信息外，还需声明的是，这些部件并非是有用铅 (Pb), 汞 (Hg), 镉 (Cd), 六价铬 (Cr(+VI)), 多溴联苯 (PBB) 或多溴二苯醚 (PBDE) 来制造的。

Apart from the disclosures in the above table, the subassemblies are not intentionally manufactured or formulated with lead (Pb), mercury (Hg), cadmium (Cd), hexavalent chromium (Cr+VI), polybrominated biphenyls (PBB), and polybrominated diphenyl ethers (PBDE).

Products manufactured by BRAND may enter into further devices or can be used together with other appliances. With these third party products and appliances in particular, please note the EFUP labeled on these products. BRAND will not take responsibility for the EFUP of those products and appliances.

Place, date: Wertheim, 05|04|2022



Patrick Ziemeck
(Managing Director Technology)



i.A. Siegfried Ott
(Regulatory Affairs)

Table des matières

1	Introduction.....	75
1.1	Étendue de la livraison	75
1.2	Conditions d'utilisation	75
2	Sécurité.....	77
2.1	Fonction.....	78
2.2	Limites d'utilisation	78
2.3	Interdictions d'emploi	78
2.4	Conditions de stockage	79
3	Éléments fonctionnels et de commande	80
4	Mise en service	82
4.1	Raccordement de l'accu	82
4.2	Chargement de l'accu	84
4.3	Démarrer l'appareil.....	85
4.4	Sélectionner le mode de fonctionnement.....	85
4.5	Aspirer ou doser le liquide	85
4.6	Modifier la vitesse de pipetage.....	86
4.7	Régler la vitesse de rotation du moteur.....	86
4.8	Conserver l'appareil.....	86
5	Pipetage	88
6	Nettoyage.....	90
6.1	Contrôler l'étanchéité.....	90
6.2	Remplacer le filtre et nettoyer l'adaptateur	90
6.3	Désinfection aux UV	93
7	Dysfonctionnement - que faire ?	94
8	Caractéristiques techniques	95
8.1	Marquage sur le produit.....	95

9 Réparation.....	97
9.1 Retour pour réparation.....	97
10 Informations sur la commande	99
10.1 Appareil.....	99
10.2 Pièces détachées.....	99
11 Responsabilité pour défauts	101
12 Évacuation.....	102

1 Introduction

1.1 Étendue de la livraison

Controlador de la pipeta, batería de níquel-hidruro metálico, fuente de alimentación opcional (tenga en cuenta los diferentes números de pedido), 2 filtros de membrana de repuesto de 0,2 μm , soporte de pared, instrucciones de uso

1.2 Conditions d'utilisation





- Veuillez lire attentivement le mode d'emploi avant la première utilisation.
- Le mode d'emploi fait partie de l'appareil et doit être conservé de manière à pouvoir y accéder facilement.
- Veuillez joindre le mode d'emploi lorsque vous remettez cet appareil à des tiers.

1.2.1 Classes de danger

Les mots de signalisation suivants caractérisent des dangers potentiels :

Mot de signalisation	Signification
DANGER	Provoque de graves blessures ou la mort.
AVERTISSEMENT	Peut provoquer de graves blessures ou la mort.
PRUDENCE	Peut provoquer des blessures légères ou moyennes.
REMARQUE	Peut provoquer un dommage matériel.

1.2.2 Symboles du mode d'emploi

Symbole	Signification	Symbole	Signification
	Point de danger		Risque d'explosion
	Porter une protection des yeux		Porter des gants de protection

1.2.3 Représentation

Représentation	Signification	Représentation	Signification
1. Task	Caractérise une tâche.	>	Caractérise une condition.
a., b., c.	Caractérise une étape individuelle de la tâche.	⇒	Caractérise un résultat.

2 Sécurité

À lire attentivement !

L'appareil de laboratoire accu-jet® S peut être utilisé avec des matériaux, des procédés et des appareillages dangereux. Le mode d'emploi n'a pas pour but d'exposer tous les problèmes de sécurité susceptibles de se présenter. Il relève donc de la responsabilité de l'utilisateur d'assurer le respect des consignes de sécurité et de santé et de déterminer les restrictions correspondantes avant l'utilisation de l'appareil.

1. Tous les utilisateurs doivent avoir lu ce mode d'emploi avant l'utilisation de l'appareil et la respecter.
2. Respecter les indications générales de danger et les consignes de sécurité, par ex. porter des vêtements de protection, une protection oculaire et des gants de protection.
3. Suivre les recommandations des fabricants de réactifs.
4. Ne pas utiliser l'appareil dans une atmosphère à risque d'explosion et ne pas pipeter de liquides facilement inflammables.
5. Employer uniquement l'appareil pour le pipetage de liquides en observant les limites et les restrictions d'emploi définies. Observer les interdictions d'emploi, voir point Interdictions d'emploi, p. 78 ! En cas de doute, se renseigner auprès du fabricant et/ou du fournisseur.
6. Toujours travailler de façon à ne mettre en danger ni vous-même ni autrui. Éviter les éclaboussures. N'utiliser que des récipients appropriés.
7. Ne jamais employer la force.
8. N'utiliser que des accessoires originaux et des pièces de rechange originales. Ne pas effectuer de modifications techniques. Ne pas démonter l'appareil plus que ce qui est décrit dans le mode d'emploi !
9. Avant l'utilisation, vérifier l'état correct de l'appareil. Si des dérangements se manifestent, arrêter immédiatement le pipetage et consulter le chapitre Störung - Was tun?. Au besoin, contacter le fabricant.
10. Toujours utiliser le bloc d'alimentation d'origine pour recharger l'accu nickel-hydrure de métal.

11. L'accu ne doit pas être échangé contre des accus d'autres fabricants.
12. Protéger le bloc d'alimentation contre l'humidité et ne l'utiliser qu'avec cet appareil.
13. Ne plus utiliser le bloc d'alimentation si le câble de raccordement est endommagé.
14. Les réparations et les interventions dans l'appareil ne doivent être effectuées que par des techniciens de service autorisés.

2.1 Fonction

L'appareil sert d'aide au pipetage de liquides avec des pipettes de mesure et pleines en verre ou en plastique, d'un volume compris entre 0,1 ml et 200 ml et avec un diamètre extérieur du tube d'aspiration < 9,2 mm. Si l'appareil est utilisé correctement, le liquide pipeté n'entre en contact qu'avec la pipette.

2.2 Limites d'utilisation

L'appareil sert au pipetage de liquides sous réserve des limites physiques suivantes :

- de +10 °C à +40 °C (de 50 °F à 104 °F) (de l'appareil et du réactif)
- pression de vapeur jusqu'à 500 mbars max. Au-dessus de 300 mbar, aspirer lentement afin d'éviter un bouillonnement du liquide.
- Densité jusqu'à 9 g/cm³

2.3 Interdictions d'emploi

L'appareil ne doit pas être utilisé pour des liquides dont les vapeurs ont un effet corrosif ou attaquent le silicone ou l'EPDM.

L'appareil n'est pas adapté à une utilisation avec des pipettes Pasteur.

AVERTISSEMENT



Fonctionnement de l'appareil dans un environnement à risque d'explosion

L'appareil ne doit pas être utilisé ou chargé dans un environnement à risque d'explosion. Ne pas pipeter de liquides facilement inflammables (point de combustion sous 0 °C (32 °F) par ex. éther, acétone).

2.4 Conditions de stockage

Entreposer l'appareil et les accessoires uniquement à l'état nettoyé, au frais et au sec.

Température d'entreposage de -20°C à + 50°C (de -4°F à 122°F).

Humidité relative de l'air : de 5 % à 95 %.

3 Éléments fonctionnels et de commande

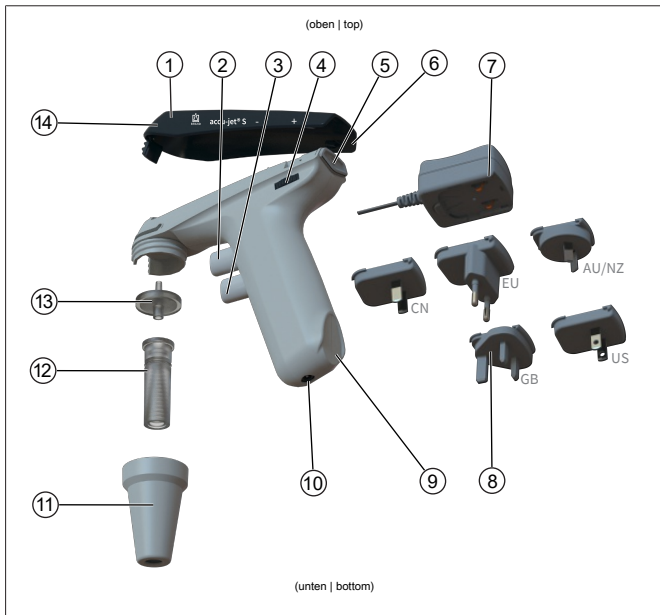

- | | | | |
|----|--|----|---|
| 1 | Coque supérieure du boîtier | 2 | Bouton de pipetage supérieur (absorption de liquide) |
| 3 | Bouton de pipetage inférieur (dosage de liquide) | 4 | Molette de réglage pour vitesse de rotation du moteur |
| 5 | Sélecteur du mode de fonctionnement | 6 | Surface d'appui de la coque supérieure du boîtier |
| 7 | Bloc secteur | 8 | Adaptateurs pour différents pays |
| 9 | Surface d'appui de la poignée | 10 | Douille de chargement |
| 11 | Boîtier d'adaptateur (PP) | 12 | Adaptateur / soupape antiretour (SI/PTFE) |
| 13 | Filtre à membrane (PP/PTFE) | 14 | Ouverture de compensation de pression |

Pour des indications concernant la tension et la consommation de courant, voir Caractéristiques techniques, p. 95 .

Abr.	Matériau
PP	Polypropylène
PTFE	Polytétrafluoréthylène
SI	Silicone

4 Mise en service

4.1 Raccordement de l'accu

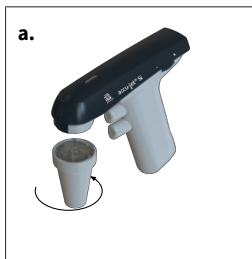

- a.** Dévisser le boîtier d'adaptateur.
L'adaptateur et le filtre restent dans le boîtier de l'adaptateur.

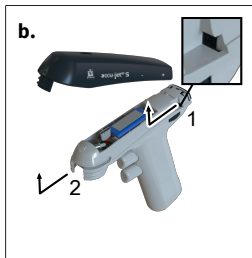

- b.** Retirer le boîtier. Pousser légèrement le boîtier vers le vissage du boîtier de l'adaptateur.
- ⇒ Le boîtier se détache des encoches situées au-dessus de la molette de réglage (1) et du vissage du boîtier de l'adaptateur (2).
- ⇒ Le compartiment à batterie devient visible.

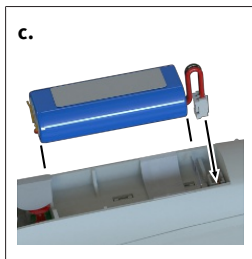

- c.** Tenir le connecteur de l'accu sur le câble, orienter en conséquence et enfoncer fixement dans la douille jusqu'à l'enclenchement audible. Insérer l'accu.

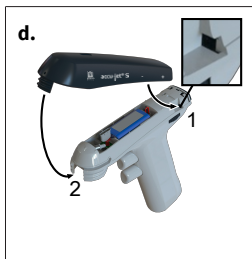

- d.** Placer le boîtier. Ce faisant, veiller à ce que le boîtier s'enclenche dans les cavités prévues au-dessus de la molette de réglage (1) et dans le raccord vissé du boîtier de l'adaptateur (2).

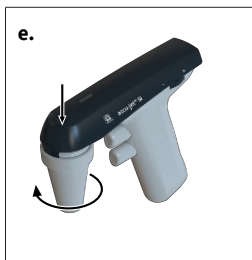

- e.** Appuyer la partie supérieure du boîtier dans les coques du boîtier et visser le boîtier d'adaptateur.

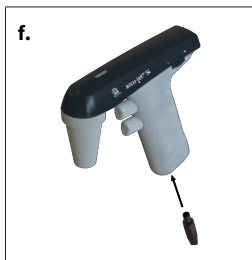

- f.** Charger l'accu jusqu'à ce que l'indicateur à LED clignote en vert. Temps de charge env. 4 heures, voir Chargement de l'accu.

4.2 Chargement de l'accu

⚠ AVERTISSEMENT



Bloc secteur ou câble de chargement endommagé

Risque de blessure par un choc électrique



> Ne pas utiliser un bloc secteur endommagé.

> Si le câble de chargement est endommagé, ne pas utiliser le bloc secteur.

AVIS

N'utiliser que le bloc secteur original du fabricant !

L'utilisation d'un autre bloc secteur peut endommager l'appareil ainsi que l'accu.

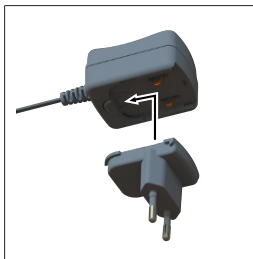

- a. Brancher l'adaptateur de pays sur le bloc secteur.
 - b. Raccorder le bloc secteur à l'appareil.
 - c. Brancher le bloc secteur sur la fiche secteur.
- ⇒ L'appareil est en charge. Cela se voit sur l'indicateur de chargement à LED sur la partie supérieure du boîtier. Pour la durée d'utilisation et la durée de chargement, voir les Caractéristiques techniques, p. 95.

Indicateur de chargement à LED	État	Que faire ?
Vert : clignotant	L'accu est en charge. La charge de maintien est en cours.	Vous pouvez travailler avec l'appareil. L'appareil est entièrement chargé.
Vert : allumé en continu	L'accu est en charge	Vous pouvez continuer de travailler pendant le chargement.
Rouge : clignotant	L'accu est presque vide.	Arrêtez votre activité avec l'appareil. Chargez l'accu.

Indicateur de chargement à LED	État	Que faire ?
		Vous pouvez continuer de travailler pendant le chargement.
Rouge : allumé en continu	L'accu est vide.	Chargez l'accu.

AVIS

- La charge de maintien empêche la surcharge et réduit l'effet de lazy-battery. Pour conserver la capacité maximale, ne recharger l'accu que si cela est requis par l'indicateur de chargement à LED.

4.3 Démarrer l'appareil

L'appareil est prêt au fonctionnement lorsqu'un accu charge est inséré. Il n'y a pas de bouton ON/OFF.

4.4 Sélectionner le mode de fonctionnement

Sélecteur, voir Éléments fonctionnels et de commande, p. 80 .

Mode de fonctionnement « Écoulement libre » : glisser le sélecteur vers le haut.

Mode de fonctionnement « Soufflage avec assistance du moteur » : glisser le sélecteur vers le bas.

4.5 Aspirer ou doser le liquide

Bouton de pipetage, voir Éléments fonctionnels et de commande, p. 80

Pour remplir la pipette, appuyer sur le bouton de pipetage supérieur et pour doser, appuyer sur le bouton de pipetage inférieur.

4.6 Modifier la vitesse de pipetage

La vitesse est limitée par la vitesse de rotation du moteur maximale réglée. Plus le bouton de pipetage supérieur ou inférieur est enfoncé profondément, plus le liquide est absorbé ou dosé rapidement.

4.7 Régler la vitesse de rotation du moteur

Molette de réglage, voir Éléments fonctionnels et de commande, p. 80

La vitesse de rotation du moteur peut être réglée en continu du maximum (+) au minimum (-) en tournant la molette de réglage. Nous recommandons la vitesse de rotation du moteur maximale pour les pipettes de grand volume et une vitesse de rotation du moteur plus basse pour les pipettes de petit volume.

4.8 Conserver l'appareil

4.8.1 Tablette

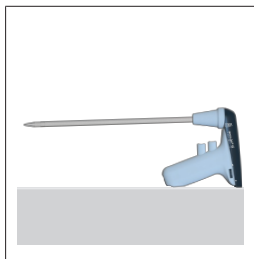

Le accu-jet® S peut être déposé sur une surface plane avec la pipette insérée.

4.8.2 Support mural



- a. Nettoyer la surface de fixation avec un nettoyant adapté (pas de nettoyants domestiques graissants) et un chiffon non pelucheux et bien la laisser sécher.
- b. Retirer le film protecteur des bandes adhésives
- c. Enfoncer le support mural **fixement** sur la surface de fixation.

5 Pipetage

1. Insérer la pipette

⚠ AVERTISSEMENT



Veiller à la bonne assise de la pipette. Ne jamais employer la force ! Il existe un risque de bris de verre, en particulier pour les pipettes fines ! Risque de blessures !

1.



- Toujours tenir la pipette le plus près possible de l'extrémité supérieure et la glisser prudemment dans l'adaptateur jusqu'à ce qu'elle soit solidement installée.
- Toujours maintenir l'appareil avec la pipette insérée à la verticale, la pointe vers le bas.

2. Remplissage de la pipette

2.

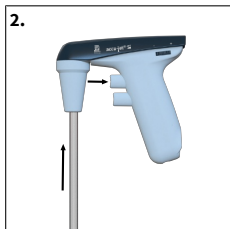

- Plonger la pointe de la pipette dans le liquide.
- Enfoncer lentement le bouton de pipetage supérieur et remplir la pipette de sorte que le ménisque soit légèrement au-dessus des marques souhaitées.
- Si les deux boutons de pipetage sont appuyés, vous pouvez absorber ou doser le liquide très précisément. Ce-

la est particulièrement utile si vous réglez le ménisque ou si vous utilisez des pipettes avec de petits volumes.

AVIS

Ne pas remplir excessivement la pipette.

3. Régler le volume

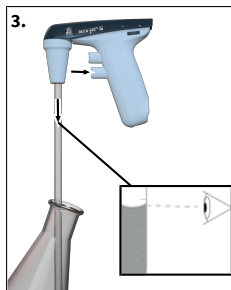

- a. Essuyer éventuellement la pointe de la pipette avec un chiffon non pelucheux adapté.
- b. Enfoncer lentement le bouton de pipetage inférieur et doser le liquide jusqu'à ce que le ménisque soit réglé précisément sur la marque souhaitée.

4. Vidage de la pipette

- a. Enfoncer lentement le bouton de pipetage inférieur. La vitesse de pipetage dépend du niveau d'enfoncement des boutons de pipetage. En mode de fonctionnement « Soufflage avec assistance du moteur », elle dépend également de la vitesse de rotation du moteur.

5. Après le pipetage

- a. Saisir la pipette le plus haut possible et la retirer de l'adaptateur.

6 Nettoyage

AVIS

Le accu-jet® S n'est pas autoclavable

Essuyer les pièces du boîtier de temps en temps avec un chiffon humide. L'appareil ne requiert pas d'entretien s'il est utilisé correctement.

6.1 Contrôler l'étanchéité

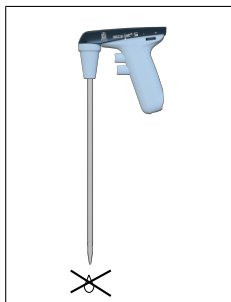

Après le réglage du ménisque, le liquide ne doit pas goutter hors de la pipette sans actionnement des soupapes. Si la pipette goutte, voir Dysfonctionnement - que faire ?

6.2 Remplacer le filtre et nettoyer l'adaptateur

⚠ AVERTISSEMENT



Risque de contamination et d'infection

Porter des gants de protection et une protection des yeux.



Un remplacement du filtre ou le nettoyage est uniquement nécessaire si une pipette a été trop remplie ou si la puissance d'aspiration est compromise.

b.

- a.** Retirer la pipette.
- b.** Dévisser le boîtier d'adaptateur.
- c.** Retirer le boîtier supérieur.

d.

- d.** Chasser l'adaptateur et la membrane filtrante du côté conique du boîtier d'adaptateur.

e.

- e.** Retirer un filtre à membrane défectueux.

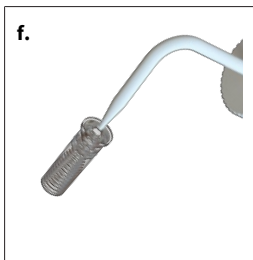

- f.** Pour le nettoyage de l'adaptateur, rincer soigneusement avec un flacon pulvérisateur rempli d'un liquide de nettoyage approprié, par ex. de l'eau. Puis, souffler et sécher.

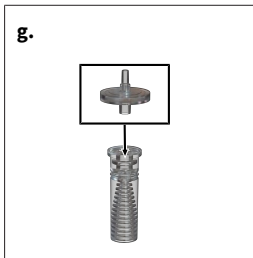

- g.** Enfoncer le nouveau filtre à membrane tout d'abord dans l'adaptateur, avec le raccord plus épais vers le bas (le côté conique, plus fin, vers le haut) et placer dans le boîtier d'adaptateur.

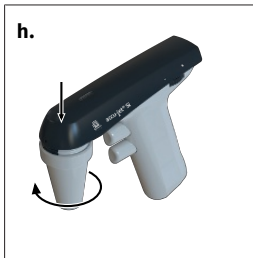

- h.** Appuyer la partie supérieure du boîtier dans les coques du boîtier et visser le boîtier d'adaptateur.

Remarque sur les filtres autoclavables

L'efficacité de l'autoclavage doit être contrôlée par l'utilisateur lui-même. Les filtres à membrane ne sont pas tous adaptés ! Utiliser uniquement des accessoires d'origine.

- > L'appareil est équipé en série d'une membrane filtrante 0,2 µm (code couleur rouge).
 - > La membrane filtrante est autoclavable jusqu'à cinq fois à 121 °C (250 °F).
 - > Une membrane filtrante 0,2 µm (pour culture cellulaire) permet d'atteindre des tolérances de volume de classe B.
 - > Pour respecter les tolérances de volume de classe A, des membranes filtrantes de 3 µm sont requises. En raison de la plus grande largeur de pores, celles-ci ont moins d'influence sur la durée d'écoulement libre des pipettes, voir .
-

6.3 Désinfection aux UV

L'appareil résiste à la sollicitation habituelle que représente une lampe de désinfection aux UV. Un changement de couleur est possible en raison de l'effet produit par les UV.

7 Dysfonctionnement - que faire ?



Dysfonctionnement	Cause	Que faire ?
Puissance d'aspiration compromise	La vitesse de rotation du moteur est réduite	Augmenter la vitesse de rotation du moteur, voir Régler la vitesse de rotation du moteur, p. 86 .
	Soupape antiretour fermée	Mettre le sélecteur sur Soufflage et appuyer sur le bouton de pipetage inférieur, voir Sélectionner le mode de fonctionnement, p. 85
La pipette goutte	Le filtre n'est pas correctement installé	Installer correctement le filtre, voir Remplacer le filtre et nettoyer l'adaptateur, p. 90 .
	Adaptateur ou pipette endommagé(e)	Remplacer l'adaptateur ou la pipette, voir Remplacer le filtre et nettoyer l'adaptateur, p. 90 .
La pipette ne tient pas dans l'adaptateur	Adaptateur encrassé ou endommagé	Nettoyer l'adaptateur, le sécher à l'air, le remplacer éventuellement, voir Remplacer le filtre et nettoyer l'adaptateur, p. 90 .
L'indicateur de chargement à LED n'est pas allumé / ne clignote pas après le raccordement du bloc secteur et après l'application de l'alimentation en tension.	Le connecteur de l'accu n'est pas fixement enfoncé	Enficher fixement le connecteur de l'accu, voir Raccordement de l'accu, p. 82 .
	Bloc secteur incorrect	Utiliser uniquement un bloc secteur d'origine, voir Éléments fonctionnels et de commande, p. 80
	Accu ou bloc secteur défectueux	Remplacer l'accu / le bloc secteur
	Appareil défectueux	Envoyer l'appareil en vue de la réparation, voir Réparation, p. 97
Faible capacité de l'accu	Accu défectueux	Remplacer l'accu, voir Raccordement de l'accu, p. 82 .
L'appareil ne montre aucune fonction	Erreur interne (exécuter une réinitialisation)	Desserrer le connecteur de l'accu et maintenir un bouton de pipetage appuyé pendant 10 secondes. Puis, insérer à nouveau fixement le connecteur de l'accu, voir Raccordement de l'accu, p. 82 et Pipetage, p. 88

Si le problème ne peut pas être résolu à l'aide du tableau de défauts ci-dessus, veuillez vous adresser à votre revendeur spécialisé ou directement au fabricant.

8 Caractéristiques techniques

Caractéristiques techniques	Valeurs
Douille de chargement	5 VDC
Bloc secteur	Entrée : 100 – 240 VAC, 50/60 Hz Sortie : 5 VDC
Accu	Bloc d'accu NiMH 2,4 V, 730 mAh Temps de chargement : 4 h Durée de travail maximale : env. 8 h Température de chargement : +10 °C à +35 °C

8.1 Marquage sur le produit

Signe ou numéro	Signification
XXZXXXXX	Numéro de série
Quick Response Code	Contient le numéro de série
	Par ce label, nous confirmons que le produit correspond aux exigences spécifiées dans les directives CE et qu'il a été soumis aux procédures de contrôle définies.
	UKCA : United Kingdom Conformity Assessed Par ce label, nous confirmons que le produit correspond aux exigences spécifiées dans les UK Designated Standards.
www.brand.de/ip	Informations relatives aux brevets
 (Ici : 40 ans)	China RoHS (EFUP) L'EFUP définit la période en années durant laquelle les substances dangereuses contenues dans les appareils électriques et électroniques ne s'écoulent pas ou ne changent pas sous des conditions d'utilisation normales. En cas d'utilisation normale par l'utilisateur, de tels produits électriques et électroniques ne causent pas de graves souillures causées à l'environnement, de graves blessures corporelles ou d'endommagements des valeurs matérielles de l'utilisateur.

Signe ou numéro	Signification
	L'appareil électrique ne doit pas être jeté à la poubelle contenant des ordures ménagères.

9 Réparation

9.1 Retour pour réparation

AVIS

Transporter des substances dangereuses sans autorisation est interdit par la loi.

Nettoyez et décontaminez soigneusement l'appareil !

- Renvoyer l'appareil, de principe joindre une description précise du type de dysfonctionnement et des fluides utilisés. Si les liquides utilisés ne sont pas indiqués, l'appareil ne pourra pas être réparé.
- Envoyez l'appareil exclusivement sans accu ou batterie.
- Tout retour est aux périls et aux frais de l'expéditeur.

En dehors des États-Unis et du Canada

Remplir « l'Attestation de Décontamination » et la retourner avec l'appareil au fabricant ou au revendeur. Demander le formulaire au fournisseur ou au fabricant ou bien en téléchargement gratuit sous www.brand.de.

Aux États-Unis et au Canada :

Merci de contacter BrandTech Scientific, Inc. pour demander les conditions de retour de l'appareil **avant** de le renvoyer au service après-vente.

Renvoyer uniquement des appareils nettoyés et décontaminés à l'adresse reçue avec le numéro de retour. Le numéro de retour doit être apposé à l'extérieur du colis de façon bien visible.

Adresses de contact

Allemagne :

BRAND GMBH + CO KG
Otto-Schott-Straße 25
97877 Wertheim (Germany)
T +49 9342 808 0
F +49 9342 808 98000
info@brand.de
www.brand.de

États-Unis et Canada :

BrandTech® Scientific, Inc.
11 Bokum Road
Essex, CT 06426-1506 (USA)
T +1- 860- 767 2562
F +1- 860- 767 2563
info@brandtech.com
www.brandtech.com

Inde :

BRAND Scientific Equipment Pvt. Ltd.
303, 3rd Floor, 'C' Wing, Delphi
Hiranandani Business Park,
Powai
Mumbai-400 076 (Inde)
T +91 22 42957790
F +91 22 42957791
info@brand.co.in
www.brand.co.in

Chine :

BRAND (Shanghai) Trading Co., Ltd.
Guangqi Culture Plaza
Room 506, Building B
No. 2899, Xietu Road
Shanghai 200030 (P.R. China)
T +86 21 6422 2318
F +86 21 6422 2268
info@brand.com.cn
www.brand.cn.com

10 Informations sur la commande

10.1 Appareil

Couleur de la partie supérieure du boîtier	Réf. de commande (avec bloc secteur universel et adaptateur de pays)	Réf. de commande (sans bloc secteur universel et sans adaptateur de pays)
Anthracite	26350	26360
Baies	26351	26361
Pétrole	26352	26362
Améthyste	26353	26363

Étendue de la livraison, voir . Notez les références de commande, avec ou sans bloc secteur.

10.2 Pièces détachées

Membrane filtrante de rechange

Description	Unité d'emb.	N° de commande
0,2 µm, stérile (code couleur rouge)	1 unité dans emballage blister	26530
0,2 µm	10 unités dans sachet en PE	26535
3 µm	1 unité dans emballage blister	26052
3 µm	10 unités dans sachet en PE	26056

Bloc secteur

Caractéristiques techniques du bloc secteur, voir Caractéristiques techniques, p. 95 .

Type	N° de commande
Bloc d'alimentation avec adaptateur pays	26606

Bloc d'accu

Caractéristiques techniques de l'accu, voir Caractéristiques techniques, p. 95 .

Description	N° de commande
Bloc d'accu NiMH	26630

Adaptateur silicone avec soupape antiretour

Description	N° de commande
Adaptateur silicone	26508

Boîtier d'adaptateur

Couleur	N° de commande
blanc	26658

Support mural

Couleur	N° de commande
blanc	26539

Ruban adhésif

Unité d'emb	N° de commande
3 jeux	26547

11 Responsabilité pour défauts

Nous déclinons toute responsabilité en cas de conséquences d'un traitement, d'une utilisation, d'un entretien et d'une manipulation incorrects, d'une réparation non autorisée de l'appareil ou d'une usure normale, notamment des pièces d'usure, telles que les pistons, les joints d'étanchéité, les soupapes, et de rupture de pièces en verre. Ceci vaut pour le non-respect du mode d'emploi. Nous déclinons toute responsabilité en cas de dommages résultant d'actions non décrites dans le mode d'emploi ou si des pièces détachées ou des accessoires autres que ceux d'origine ont été utilisés.

États-Unis et Canada :

Vous trouverez des informations sur la responsabilité en cas de vices sous www.brandtech.com.

12 Évacuation



Le symbole ci-contre signifie que les piles/batteries ainsi que les appareils électroniques qui ont atteint la fin de leur durée de vie doivent être éliminés séparément des déchets domestiques (déchets d'agglomération non triés).

Les appareils électroniques doivent être correctement éliminés selon la directive 2012/19/UE du Parlement européen et du Conseil du 04 juillet 2012 sur les appareils électriques et électroniques usés conformément aux prescriptions d'évacuation nationales.

Les piles et les accus contiennent des substances qui peuvent avoir des répercussions nocives sur l'environnement et sur la santé des êtres humains. Ils doivent donc être correctement évacués selon la directive 2006/66/CE du Parlement européen et du Conseil du 6 septembre 2006 sur les batteries et les accumulateurs conformément aux prescriptions d'évacuation nationales. N'éliminer que des piles et des accus complètement déchargés.

EU-Konformitätserklärung | EU Declaration of Conformity

Produktbezeichnung: Product name:	Pipettierhelfer accu-jet® S / Pipetting controller accu-jet® S
Produktvarianten: Product variations:	Anthrazit, Beere, Petrol, Amethyst / anthracite, berry, petrol, amethyst
Art-Nr. / Cat.-No.	26350, 26351, 26352, 26353, 26360, 26361, 26362, 26363

Das oben beschriebene Produkt entspricht den grundlegenden Anforderungen, die in den nachfolgend bezeichneten Harmonisierungsrechtsvorschriften festgelegt sind: The product described above meets the basic requirements that are specified in the harmonization legislation listed below:	Angewendete harmonisierte Normen: Applied harmonized standards:
RoHS: 2011/65/EU incl.2015/863/EU EMC: 2014/30/EU	EN IEC 63000:2018 EN 61326-1:2013
Weitere angewendete Normen: Other applied standards:	Geltungsbereich: Scope:
EN 61010-1:2010, EN 61010-1:2010/A1:2019/AC:2019-04 EN/IEC 62368-1:2014 (angewendet auf Fremdherstellernetzteil / applied to third-party power supply)	NRL / LVD NRL / LVD

Die alleinige Verantwortung für die Ausstellung dieser Konformitätserklärung in Bezug auf die Erfüllung der grundlegenden Anforderungen und die Anfertigung der technischen Unterlagen trägt der Hersteller.

The manufacturer is solely responsible for issuing this declaration of conformity with regard to meeting the essential requirements and preparing the technical documentation.

Hersteller / Manufacturer	Adresse / Address
BRAND GMBH + CO KG	Otto-Schott-Str. 25 97877 Wertheim Germany

Wertheim, 01. Juli 2022 / 01 July 2022



Patrick Ziemeck
Managing Director Technology



i.A. Siegfried Ott
Regulatory Affairs

Diese Erklärung bescheinigt die Übereinstimmung mit den genannten Harmonisierungsvorschriften, beinhaltet jedoch keine Zusicherung von Eigenschaften.

This document declares the accordance with the named harmonized regulations, but does not assure specific properties.

UK Declaration of Conformity

Product name: Pipetting controller accu-jet® S
Product variations: anthracite, berry, petrol, amethyst
Cat.-No. 26350, 26351, 26352, 26353, 26360, 26361, 26362, 26363

The product described above meets the basic requirements that are specified in the harmonization legislation listed below:	Applied harmonized standards:
The Restriction of the Use of Certain Hazardous Substances in Electrical and Electronic Equipment Regulations 2012 (SI 2012 No. 3032)	EN IEC 63000:2018
Electromagnetic Compatibility Regulations 2016 (SI 2016 No. 1091, as amended by SI 2019 No. 696)	EN 61326-1:2013
Other applied standards:	Scope:
EN 61010-1:2010, EN 61010-1:2010/A1:2019/AC:2019-04 EN/IEC 62368-1:2014 (angewendet auf Fremdherstellernetzteil / applied to third-party power supply)	LVD LVD

The manufacturer is solely responsible for issuing this declaration of conformity with regard to meeting the essential requirements and preparing the technical documentation.

Manufacturer	Address
BRAND GMBH + CO KG	Otto-Schott-Str. 25 97877 Wertheim Germany

Wertheim, 18 February 2022



Patrick Ziemeck
Managing Director Technology



i.A. Siegfried Ott
Regulatory Affairs

This document declares the accordance with the named harmonized regulations, but does not assure specific properties.

Declaration of conformity – China RoHS 2

BRAND GMBH + CO KG has made reasonable efforts to ensure that hazardous materials and substances may not be used in BRAND products.

In order to determine the concentration of hazardous substances in all homogeneous materials of the subassemblies, a “Product Conformity Assessment” (PCA) procedure was performed. As defined in GB/T 26572 the “Maximum Concentration Value” limits (MCV) apply to these restricted substances:

+ Lead (Pb):	0.1%	+ Hexavalent chromium (Cr(+VI)):	0.1%
+ Mercury (Hg):	0.1%	+ Polybrominated biphenyls (PBB):	0.1%
+ Cadmium (Cd):	0.01%	+ Polybrominated diphenyl ether (PBDE):	0.1%

Environmental Friendly Use Period (EFUP)

EFUP defines the period in years during which the hazardous substances contained in electrical and electronic products will not leak or mutate under normal operating conditions. During normal use by the user such electrical and electronic products will not result in serious environmental pollution, cause serious bodily injury or damage to the user's assets.

The Environmental Friendly Use Period for BRAND instruments is 40 years.



Material Content Declaration for BRAND Products

部件名称 Part name	有毒有害物质或元素 Hazardous substances					
	铅 Pb	汞 Hg	镉 Cd	六价铬 Cr(+VI)	多溴联苯 PBB	多溴二苯醚 PBDE
包装 / Packaging	0	0	0	0	0	0
塑料外壳 / 组件 Plastic housing / parts	0	0	0	0	0	0
电池 / Battery	0	0	0	0	0	0
玻璃 / Glass	0	0	0	0	0	0
电子电气组件 Electrical and electronic parts	X	0	0	0	0	0
金属外壳 / 组件 Metal housing / parts	X	0	0	0	0	0
电机 / Motor	X	0	0	0	0	0
配件 / Accessories	X	0	0	0	0	0

此表格是按照SJ/T 11364-2014中规定所制定的。

This table is created according to SJ/T 11364-2014.

- O: 表示该有毒有害物质在该部件所有均质材料中的含量均在GB/T 26572规定的限量要求以下。
- O: Indicates that the above mentioned hazardous substance contained in all homogeneous materials of the part is below the required limit as defined in GB/T 26572.
- X: 表示该有毒有害物质至少在该部件某一均质材料中的含量超出GB/T 26572规定的限量要求。
- X: Indicates that the above mentioned hazardous substance contained in at least one of the homogeneous materials of this part is above the required limit as defined in GB/T 26572.

注释： 电池，玻璃制品和配件可能不属于此设备的一部分且/或可能有它自己的EFUP标志且/或可能包含更改EFUP标志的部件。

Note: Batteries, glassware and accessories might not be content of the enclosed device and/or may have their own EFUP-marking and/or might be maintaining parts with changing EFUP-marking.

除上表所示信息外，还需声明的是，这些部件并非是有用铅 (Pb), 汞 (Hg), 镉 (Cd), 六价铬 (Cr(+VI)), 多溴联苯 (PBB) 或多溴二苯醚 (PBDE) 来制造的。

Apart from the disclosures in the above table, the subassemblies are not intentionally manufactured or formulated with lead (Pb), mercury (Hg), cadmium (Cd), hexavalent chromium (Cr+VI), polybrominated biphenyls (PBB), and polybrominated diphenyl ethers (PBDE).

Products manufactured by BRAND may enter into further devices or can be used together with other appliances. With these third party products and appliances in particular, please note the EFUP labeled on these products. BRAND will not take responsibility for the EFUP of those products and appliances.

Place, date: Wertheim, 05|04|2022



Patrick Ziemeck
(Managing Director Technology)



i.A. Siegfried Ott
(Regulatory Affairs)

1	Introducción	109
1.1	Contenido de la entrega	109
1.2	Información general sobre las instrucciones de uso.....	109
2	Seguridad	111
2.1	Función	112
2.2	Límites de empleo.....	112
2.3	Condiciones de empleo	113
2.4	Condiciones de almacenamiento.....	113
3	Elementos de mando y funcionamiento	114
4	Puesta en marcha	116
4.1	Conexión de la batería	116
4.2	Carga de la batería	118
4.3	Inicio del equipo.....	119
4.4	Selección del modo de funcionamiento	120
4.5	Aspiración o dosificación de líquido	120
4.6	Modificación de la velocidad de pipeteado	120
4.7	Ajuste del número de revoluciones del motor	120
4.8	Almacenamiento del equipo	121
5	Pipeteo	122
6	Limpieza	124
6.1	Control de estanqueidad	124
6.2	Cambio del filtro y limpieza del adaptador	125
6.3	Esterilización UV.....	127
7	¿Qué hacer en caso de averías?	128
8	Datos técnicos	129
8.1	Marcado en el producto.....	129

9 Reparación	131
9.1 Envíos para reparación	131
10 Información para pedidos	133
10.1 Equipo.....	133
10.2 Piezas de repuesto	133
11 Responsabilidad por defectos.....	135
12 Eliminación	136

1 Introducción

1.1 Contenido de la entrega

Controlador de la pipeta, batería de níquel-hidruro metálico, fuente de alimentación opcional (tenga en cuenta los diferentes números de pedido), 2 filtros de membrana de repuesto de 0,2 μm , soporte de pared, instrucciones de uso

1.2 Información general sobre las instrucciones de uso

- Leer con atención el manual de instrucciones antes de utilizar el producto por primera vez.
- El manual de instrucciones es parte del equipo y debe conservarse en un sitio de fácil acceso.
- Adjuntar el manual de instrucciones cuando se entregue este equipo a un tercero.

1.2.1 Niveles de riesgo

Las siguientes palabras de advertencia hacen referencia a posibles riesgos:

Palabra de advertencia	Significado
PELIGRO	Riesgo de lesiones graves o muerte.
ADVERTENCIA	Posible riesgo de lesiones graves o muerte.
PRECAUCIÓN	Posible riesgo de lesiones leves o moderadas.
NOTA	Posible riesgo de daños materiales.

1.2.2 Símbolos del manual de instrucciones de uso

Símbolo	Significado	Símbolo	Significado
	Sector peligroso		Peligro de explosión
	Utilizar gafas protectoras		Utilizar guantes de protección

1.2.3 Visualización

Viñeta	Significado	Viñeta	Significado
1. Tarea	Hace referencia a una tarea.	>	Hace referencia a un requisito.
a., b., c.	Hace referencia a cada uno de los pasos para realizar una tarea.	⇨	Hace referencia a un resultado.

2 Seguridad

¡Leer todo el manual con atención por favor!

El equipo de laboratorio accu-jet® S puede utilizarse en combinación con materiales, procesos de trabajo y aparatos riesgosos. No obstante, el manual de instrucciones no puede hacer referencia a todas las cuestiones que, eventualmente, podrían afectar la seguridad. Forma parte de la responsabilidad del usuario asegurar el cumplimiento de las normas de seguridad y sanitarias, y establecer los límites correspondientes antes de comenzar a utilizar el producto.

1. Todos los usuarios deben haber leído este manual de instrucciones antes de comenzar a utilizar el equipo y respetar sus disposiciones.
2. Respetar las indicaciones generales de riesgos y normas de seguridad, por ejemplo, utilizar vestimenta de protección, gafas protectoras y guantes de protección.
3. Observar las indicaciones del fabricante de los reactivos.
4. No utilizar el equipo en atmósferas con peligro de explosión y no pipetear sustancias de alta inflamabilidad.
5. Utilizar el equipo solo para pipetear líquidos y exclusivamente dentro del marco de los límites de empleo que se hayan definido. Contemplar las condiciones de empleo, véase Condiciones de empleo, p. 113. En caso de dudas, será imprescindible contactar con el fabricante o distribuidor.
6. Trabajar siempre de manera que no corran peligro ni el usuario ni otras personas. Evitar salpicaduras. Utilizar solo recipientes adecuados.
7. No utilizar nunca la fuerza.
8. Utilizar solo accesorios y piezas de repuesto originales. No realizar modificaciones técnicas. ¡No desmontar el equipo más allá de lo descrito en el manual de instrucciones!

9. Comprobar siempre que el aparato esté en buenas condiciones antes de utilizarlo. Si se detectan fallos en el equipo, cesar el pipeteado de inmediato y seguir las instrucciones del capítulo Störung - Was tun?. De ser necesario, contactar con el fabricante.
10. Utilizar únicamente la fuente de alimentación original para cargar la batería de níquel-metalhidruro.
11. No cambiar la batería por una de otro fabricante.
12. La fuente de alimentación se debe proteger de la humedad y solo puede utilizarse en combinación con este equipo.
13. Dejar de utilizar la fuente de alimentación si el cable de conexión está dañado.
14. Solo encargados autorizados del servicio técnico pueden realizar reparaciones e intervenciones en el equipo.

2.1 Función

El equipo se emplea como auxiliar para el pipeteo de líquidos con pipetas graduadas y aforadas de vidrio o plástico en el rango de volumen de 0,1 ml a 200 ml y con un diámetro exterior del tubo de succión < 9,2 mm. Al manipular el equipo de manera correcta, el líquido pipeteado solo entra en contacto con la pipeta.

2.2 Límites de empleo

El equipo se emplea para pipetear líquidos teniendo en cuenta las siguientes limitaciones físicas:

- De +10 °C a +40 °C (de 50 °F a 104 °F) (equipo y reactivo)
- Presión de vapor hasta máx. 500 mbares. Por encima de 300 mbares, aspirar lentamente para evitar la ebullición del líquido.
- Densidad hasta 9 g/cm³

2.3 Condiciones de empleo

El equipo no se puede utilizar para líquidos cuyos vapores tengan un efecto corrosivo o corroan los materiales de silicona o EPDM.

El equipo no es adecuado para ser utilizado con pipetas de Pasteur.

ADVERTENCIA



Funcionamiento del equipo en entornos con peligro de explosión

El equipo no se puede utilizar en entornos con peligro de explosión o mientras se está cargando. No se pueden pipetear medios fácilmente inflamables (punto de ignición debajo de 0 °C (32 °F), por ejemplo, éter y acetona).

2.4 Condiciones de almacenamiento

Almacenar el equipo y los accesorios limpios en un lugar fresco y seco.

Temperatura de almacenamiento: de -20 °C a 50 °C (de -4 °F a 122 °F).

Humedad relativa del aire: 5 % a 95 %.

3 Elementos de mando y funcionamiento

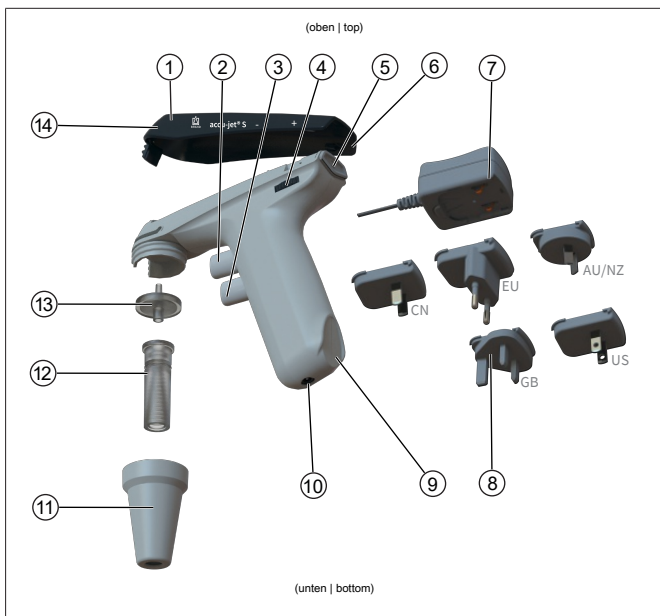

- | | |
|--|---|
| 1 Cubierta superior de la carcasa | 2 Botón de pipeteado superior (aspirar líquido) |
| 3 Botón de pipeteado superior (dosificar líquido) | 4 Rueda de ajuste del número de revoluciones del motor |
| 5 Selector del modo de funcionamiento | 6 Superficie de la cubierta superior de la carcasa |
| 7 Fuente de alimentación | 8 Adaptador para países |
| 9 Superficie de la empuñadura | 10 Toma de carga |
| 11 Carcasa de adaptador (PP) | 12 Adaptador/válvula de retención (SI/PTFE) |
| 13 Filtro de membrana (PP/PTFE) | 14 Abertura de compensación de presión |

Para más información sobre la tensión y el consumo eléctrico, véase Datos técnicos, p. 129.

Abrev.	Material
PP	Polipropileno
PTFE	Politetrafluoroetileno
SI	Silicona

4 Puesta en marcha

4.1 Conexión de la batería

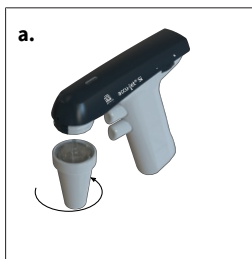

- a.** Desenroscar la carcasa de adaptador. El adaptador y el filtro quedan en la carcasa de adaptador.

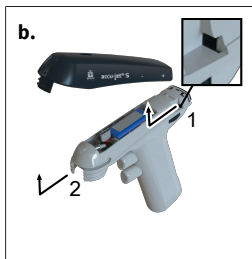

- b.** Retirar la carcasa. Desplazar la carcasa ligeramente en la dirección de la unión roscada de la carcasa del adaptador.
- ⇒ Así, la carcasa se soltará de los huecos situados sobre la rueda de ajuste (1) y de la unión roscada de la carcasa del adaptador (2).
 - ⇒ Se puede ver el compartimento de la batería.

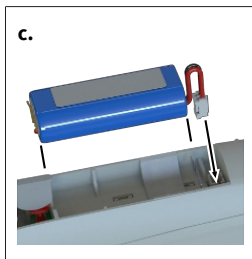

- c.** Sostener el enchufe de la batería desde el cable, alinearlos de manera adecuada y enchufarlo de forma firme en la toma hasta oír un clic de encastramiento. Colocar la batería.

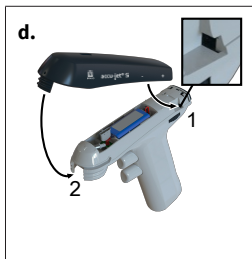

- d.** Colocar la carcasa. Al hacerlo, observar que la carcasa encaje en los huecos previstos para eso sobre la rueda de ajuste (1) y la unión roscada de la carcasa de adaptador (2).

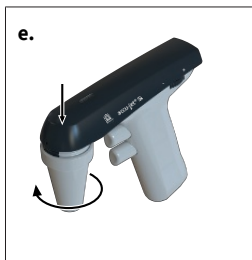

- e.** Presionar la parte superior de la carcasa y enroscar la carcasa de adaptador.

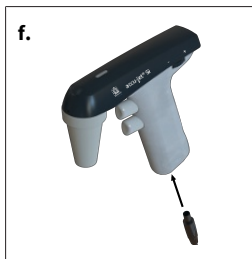

- f. Cargar la batería hasta que el indicador de carga LED verde parpadee. El tiempo de carga es de aprox. 4 horas, véase Carga de la batería.

4.2 Carga de la batería

⚠ ADVERTENCIA



Fuente de alimentación o cable de carga dañados

Riesgo de lesiones por descarga eléctrica.



- > No utilizar la fuente de alimentación cuando esté dañada.
- > Si el cable de carga está dañado, no utilizar la fuente de alimentación.

AVISO

¡Usar solo la fuente de alimentación original del fabricante!

Utilizar una fuente de alimentación diferente puede dañar el equipo o la batería.

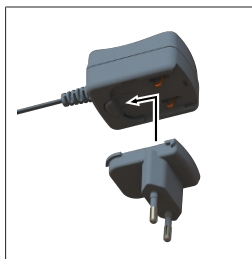

- Enchufar el adaptador para países en la fuente de alimentación.
- Conectar la fuente de alimentación con el equipo.
- Enchufar la fuente de alimentación al conector eléctrico.

- ⇒ El aparato está en proceso de carga. Esto se puede reconocer mediante el indicador de carga LED en la parte superior de la carcasa. Para la duración del funcionamiento y la duración de la carga, véanse los Datos técnicos, p. 129 .

Indicador de carga LED	Estado	¿Qué hacer?
Verde: parpadea	Batería cargada. Se está ejecutando la carga de mantenimiento.	Es posible trabajar con el equipo. El equipo está completamente cargado.
Verde: encendido de forma permanente	Batería en proceso de carga	Es posible continuar trabajando durante la carga.
Rojo: parpadea	Batería prácticamente descargada.	Interrumpir el trabajo con el equipo. Cargar la batería. Es posible continuar trabajando durante la carga.
Rojo: encendido de forma permanente	Batería descargada.	Cargar la batería.

AVISO

- La carga de mantenimiento impide la sobrecarga y reduce el efecto memoria. Para conservar la capacidad máxima, cargar la batería solo cuando el indicador de carga LED lo indique.

4.3 Inicio del equipo

El equipo está listo para funcionar cuando se coloca una batería cargada. No hay un botón de ENCENDIDO/APAGADO.

4.4 Selección del modo de funcionamiento

Selector, véase Elementos de mando y funcionamiento, p. 114 .

Modo de funcionamiento «Descarga libre»: desplazar el selector hacia arriba.

Modo de funcionamiento «Soplado motorizado»: desplazar el selector hacia abajo.

4.5 Aspiración o dosificación de líquido

Botón de pipeteado, véase Elementos de mando y funcionamiento, p. 114

Para llenar la pipeta, presionar el botón de pipeteado superior y, para dosificar, el botón de pipeteado inferior.

4.6 Modificación de la velocidad de pipeteado

La velocidad se limita al número de revoluciones máximo ajustado. Cuanto más se presione el botón de pipeteado superior o inferior, más rápido se aspirará o dosificará el líquido.

4.7 Ajuste del número de revoluciones del motor

Rueda de ajuste, véase Elementos de mando y funcionamiento, p. 114

El número de revoluciones del motor puede ajustarse de manera continua de máximo (+) a mínimo (-) girando la rueda de ajuste. Recomendamos el número de revoluciones máximo del motor para pipetas de volúmenes grandes y un número de revoluciones menor para pipetas de volúmenes pequeños.

4.8 Almacenamiento del equipo

4.8.1 Depósito sobre la mesa

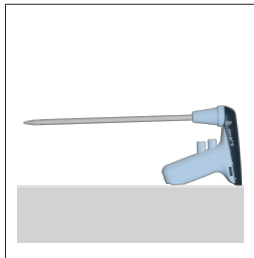

El accu-jet® S puede depositarse sobre una superficie plana con la pipeta colocada.

4.8.2 Soporte de pared



- Limpiar la superficie de fijación con un agente de limpieza adecuado (no limpiadores domésticos pringosos) y un paño sin pelusas, y dejar que se seque bien.
- Retirar la lámina de protección de la tira adhesiva
- Presionar el soporte de pared **con firmeza** sobre la superficie de fijación.

5 Pipeteo

1. Insertar la pipeta

⚠ ADVERTENCIA



Verificar que la pipeta se haya ajustado con firmeza. ¡No utilizar nunca la fuerza! ¡En especial, en el caso de las pipetas delgadas, existe el riesgo de rotura del vidrio! ¡Riesgo de lesiones!

1.



- a. En lo posible, sujetar siempre la pipeta por el extremo superior con firmeza e introducirla con cuidado en el adaptador hasta que quede firmemente sujeta.
- b. El equipo con la pipeta colocada debe mantenerse siempre en posición vertical con la punta hacia abajo.

2. Llenar la pipeta

2.

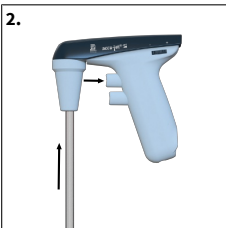

- a. Sumergir la punta de la pipeta en el líquido.
- b. Presionar el botón de pipeteado superior lentamente y llenar la pipeta de forma que el menisco se posicione apenas por arriba de las marcas deseadas.
- c. Si se presionan ambos botones de pipeteado, es posible aspirar o dosificar líquido de forma muy suave. Esto

es muy útil, en especial, cuando se ajusta el menisco o se utilizan pipetas con volúmenes chicos.

AVISO

No sobrecargar la pipeta.

3. Ajustar el volumen

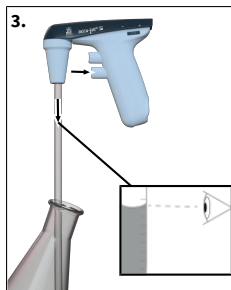

- a. De ser necesario, limpiar la punta de la pipeta con un paño adecuado sin pelusas.
- b. Presionar lentamente el botón de pipeteado inferior y dosificar líquido hasta que el menisco se haya ajustado de forma exacta en la marca deseada.

4. Vaciar la pipeta

- a. Presionar lentamente el botón de pipeteado inferior. La velocidad de pipeteado depende de cuánto se presionen los botones de pipeteado. En el modo de funcionamiento «Soplado motorizado», también depende del número de revoluciones ajustado del motor.

5. Tras pipetear

- a. Sujetar la pipeta lo más arriba posible y extraerla del adaptador.

6 Limpieza

AVISO

accu-jet® S no se puede esterilizar en autoclave

Limpiar las partes de la carcasa con un paño húmedo de forma esporádica. Si el equipo se utiliza de manera adecuada, no requiere mantenimiento.

6.1 Control de estanqueidad

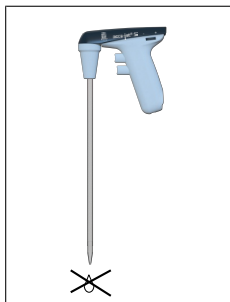

Tras ajustar el menisco, la pipeta no debe gotear ningún líquido en tanto no se accione ninguna válvula. Si la pipeta gotea, véase ¿Qué hacer en caso de averías?

6.2 Cambio del filtro y limpieza del adaptador

⚠ ADVERTENCIA



Riesgo de contaminación e infección

Utilizar guantes de protección y gafas protectoras.



AVISO

El cambio de filtro o la limpieza solo son necesarios si una pipeta se ha llenado en exceso o se encuentra afectada la capacidad de succión.

b.



- a.** Extraer la pipeta.
- b.** Desenroscar la carcasa de adaptador.
- c.** Retirar la carcasa superior.

d.



- d.** Extraer el adaptador y el filtro de membrana del lado cónico de la carcasa de adaptador.

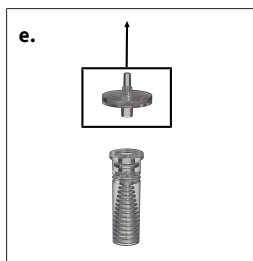

e. Retirar el filtro de membrana dañado.

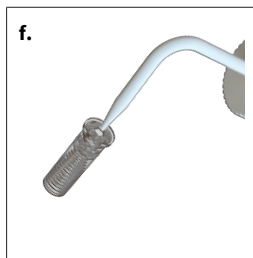

f. Limpiar el adaptador con cuidado utilizando una pisseta llena de un líquido de limpieza adecuado, como, por ejemplo, agua. A continuación, soplar y secar el adaptador.

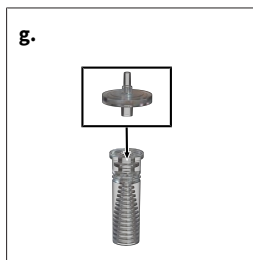

g. Introducir el nuevo filtro de membrana, primero, en el adaptador, con la conexión más gruesa hacia abajo (parte cónica más delgada hacia arriba) y en la carcasa de adaptador.

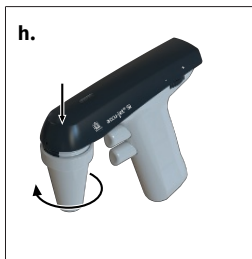

- h.** Presionar la parte superior de la carcasa y enroscar la carcasa de adaptador.

AVISO

Nota sobre los filtros esterilizables en autoclave

La eficacia de la esterilización en autoclave debe ser comprobada en cada caso por el usuario. ¡No todos los filtros de membrana son adecuados! Utilizar solo accesorios originales.

- > El equipo está equipado de fábrica con un filtro de membrana de 0,2 μm (código de color rojo).
- > El filtro de membrana se puede esterilizar en autoclave hasta cinco veces a 121 °C (250 °F).
- > Con el filtro de membrana de 0,2 μm (para cultivo celular) se pueden alcanzar tolerancias de volumen de clase B.
- > Para mantener las tolerancias de volumen de clase A se requiere un filtro de membrana de 3 μm . Debido al mayor ancho de los poros, estos tienen menor influencia en el tiempo de descarga libre de las pipetas, véase .

6.3 Esterilización UV

El equipo es resistente al efecto habitual de una lámpara UV germicida. Debido a la influencia de la radiación UV, pueden tener lugar cambios de color.

7 ¿Qué hacer en caso de averías?



Avería	Causa	¿Qué hacer?
Capacidad de succión afectada	Reducción del número de revoluciones del motor	Aumentar el número de revoluciones del motor, véase Ajuste del número de revoluciones del motor, p. 120 .
	Válvula de retención cerrada	Colocar el selector en posición de soplado y presionar el botón de pipeteado inferior, véase Selección del modo de funcionamiento, p. 120
La pipeta gotea	El filtro no está bien ajustado	Colocar el filtro correctamente, véase Cambio del filtro y limpieza del adaptador, p. 125 .
	Adaptador o pipeta dañados	Cambiar el adaptador o la pipeta, véase Cambio del filtro y limpieza del adaptador, p. 125 .
La pipeta no se mantiene en el adaptador	Adaptador sucio o dañado	Limpiar el adaptador, dejarlo secar al aire y, eventualmente, cambiarlo, véase Cambio del filtro y limpieza del adaptador, p. 125 .
El indicador de carga LED no se enciende/no parpadea tras conectar la fuente de alimentación y la alimentación eléctrica.	El enchufe de la batería no se ha conectado de forma firme	Conectar firmemente el enchufe de la batería, véase Conexión de la batería, p. 116 .
	Fuente de alimentación incorrecta	Utilizar solo la fuente de alimentación original, véase Elementos de mando y funcionamiento, p. 114
	Error en la batería o la fuente de alimentación	Cambiar la batería/fuente de alimentación
	Error en el equipo	Enviar el equipo a reparación, véase Reparación, p. 131
Capacidad disminuida de la batería	Error en la batería	Cambiar la batería, véase Conexión de la batería, p. 116 .
El equipo no muestra función alguna	Error interno (reiniciar)	Desconectar el enchufe de la batería y mantener un botón de pipeteado presionado durante 10 segundos. A continuación, volver a conectar firmemente el enchufe de la batería, véanse Conexión de la batería, p. 116 y Pipeteo, p. 122

Si no es posible solucionar el problema mediante la tabla de averías superior, contactar con el distribuidor o directamente con el fabricante.

8 Datos técnicos

Datos técnicos	Valores
Toma de carga	5 V CC
Fuente de alimentación	Entrada: 100 – 240 V CA, 50/60 Hz Salida: 5 V CC
Batería	Paquete de baterías NiMH 2,4 V, 730 mAh Tiempo de carga: 4 h Duración de trabajo máxima: aprox. 8 h Temperatura de carga: de +10 °C a +35 °C

8.1 Marcado en el producto

Marcado o número	Significado
XXZXXXXX	Número de serie
Código QR	Contiene número de serie
	Por medio de este símbolo, constatamos que el producto cumple con los requisitos establecidos en las directivas de la CE y se ha sometido a los controles estipulados.
	Marcado UKCA: United Kingdom Conformity Assessed Por medio de este símbolo, constatamos que el producto cumple con los requisitos establecidos en las UK Designated Standards.
https://www.brand.de/es/compliance/ip	Información sobre patentes
 (en este caso: 40 años)	China RoHS (EFUP) El período de uso respetuoso con el medio ambiente (EFUP, por sus siglas en inglés) define el marco temporal en años, dentro del cual las sustancias peligrosas contenidas en dispositivos eléctricos y electrónicos no se expulsarán ni mutarán mientras se mantengan las condiciones operativas normales. Siempre que el usuario lleve a cabo un uso normal, tales productos eléctricos y electrónicos no ocasionarán contaminaciones ambientales graves, lesiones graves o daños a los valores materiales del usuario.

Marcado o número	Significado
 The icon shows a simplified drawing of an electrical appliance, possibly a vacuum cleaner or a similar device, with a large 'X' drawn over it. Below the drawing is a small circle containing a lightning bolt symbol, which is a common symbol for electrical equipment. The entire icon is enclosed in a rectangular box.	El equipo eléctrico no puede desecharse junto con los residuos domésticos.

9 Reparación

9.1 Envíos para reparación

AVISO

Transportar materiales peligrosos sin autorización está prohibido por ley.

¡Limpiar y descontaminar el equipo con cuidado!

- Al enviar productos para reparación, se deberá añadir una descripción precisa del tipo de avería y de los medios utilizados. En caso de no indicar los medios utilizados, no se podrá reparar el equipo.
- Enviar el equipo exclusivamente sin las pilas o baterías.
- Los costes y riesgos de la devolución corren a cargo del remitente.

Fuera de EE. UU. y Canadá

Completar la «Declaración sobre la ausencia de riesgos para la salud» y enviarla junto con el equipo al fabricante o al distribuidor. El formulario se puede pedir al proveedor o al fabricante, o bien, se puede descargar en el sitio web www.brand.de/es.

Dentro de EE. UU. y Canadá

Contactar con BrandTech Scientific, Inc. para aclarar las condiciones de devolución del equipo **antes** de enviarlo al servicio técnico.

Enviar exclusivamente aparatos limpios y descontaminados a la dirección suministrada junto con el número de devolución. Colocar el número de devolución en la parte externa del paquete, en una zona donde pueda verse con claridad.

Direcciones de contacto

Alemania:

BRAND GMBH + CO KG
Otto-Schott-Straße 25
97877 Wertheim (Germany)
Tel.: +49 9342 808 0
Fax: +49 9342 808 98000
info@brand.de
www.brand.de

EE. UU. y Canadá:

BrandTech® Scientific, Inc.
11 Bokum Road
Essex, CT 06426-1506 (USA)
Tel.: +1-860-767 2562
Fax: +1-860-767 2563
info@brandtech.com
www.brandtech.com

India:

BRAND Scientific Equipment Pvt. Ltd.
303, 3rd Floor, 'C' Wing, Delphi
Hiranandani Business Park,
Powai
Mumbai-400 076 (India)
Tel.: +91 22 42957790
Fax: +91 22 42957791
info@brand.co.in
www.brand.co.in

China:

BRAND (Shanghai) Trading Co., Ltd.
Guangqi Culture Plaza
Room 506, Building B
No. 2899, Xietu Road
Shanghai 200030 (R. P. China)
Tel.: +86 21 6422 2318
Fax: +86 21 6422 2268
info@brand.com.cn
www.brand.cn.com

10 Información para pedidos

10.1 Equipo

Color de la parte superior de la carcasa	N.º de ref. (con fuente de alimentación universal y adaptador para países)	N.º de ref. (Sin fuente de alimentación universal y adaptador para países)
Antracita	26350	26360
Baya	26351	26361
Petróleo	26352	26362
Amatista	26353	26363

Para el contenido de la entrega, véase . Observar los números de referencia con o sin fuente de alimentación.

10.2 Piezas de repuesto

Filtro de membrana de repuesto

Descripción	Unidad por embalaje	N.º de ref.
0,2 µm, estéril (código de color rojo)	1 unidad en envase blíster	26530
0,2 µm	10 unidades en bolsa de PE	26535
3 µm	1 unidad en envase blíster	26052
3 µm	10 unidades en bolsa de PE	26056

Fuente de alimentación

Datos técnicos de la fuente de alimentación, véase Datos técnicos, p. 129.

Tipo	N.º de ref.
Fuente de alimentación con adaptador para países	26606

Paquete de baterías

Datos técnicos de la batería, véase Datos técnicos, p. 129 .

Descripción	N.º de ref.
Paquete de baterías NiMH	26630

Adaptador de silicona con válvula de retención

Descripción	N.º de ref.
Adaptador de silicona	26508

Carcasa de adaptador

Color	N.º de ref.
blanco	26658

Soporte de pared

Color	N.º de ref.
blanco	26539

Cinta adhesiva

Unidad por embalaje	N.º de ref.
3 set	26547

11 Responsabilidad por defectos

No seremos responsables de las consecuencias derivadas del trato, manejo, mantenimiento, uso incorrecto o reparación no autorizada del aparato, ni de las consecuencias derivadas del desgaste normal, en especial de partes susceptibles de abrasión, tales como émbolos, juntas herméticas, válvulas, ni de la rotura de partes de vidrio o del incumplimiento de las instrucciones de manejo. Tampoco seremos responsables de los daños, resultado de acciones no descritas en las instrucciones de manejo o por el uso de piezas de repuesto o componentes no originales.

EE.UU. y Canadá:

Encontrará informaciones sobre la garantía en el sitio www.brandtech.com.

12 Eliminación



El símbolo que puede verse al costado significa que las pilas/baterías y los equipos electrónicos deben desecharse por separado de los residuos domésticos (residuos municipales sin separar) al finalizar su vida útil.

De acuerdo con la directiva 2012/19/UE del Parlamento Europeo y del Consejo de 04 de julio de 2012 sobre residuos de aparatos eléctricos y electrónicos (RAEE), los equipos electrónicos deben desecharse de forma apropiada en función de las normas nacionales de eliminación de residuos.

Las pilas y baterías contienen sustancias que pueden tener efectos nocivos en el medio ambiente y la salud humana. Por tal motivo, de acuerdo con la directiva 2006/66/CE del Parlamento Europeo y del Consejo de 6 de septiembre de 2006 relativa a las pilas y acumuladores, deben desecharse de forma apropiada en función de las normas nacionales de eliminación de residuos. Asegurarse de que las pilas y baterías estén totalmente descargadas al desecharse.

EU-Konformitätserklärung | EU Declaration of Conformity

Produktbezeichnung: Product name:	Pipettierhelfer accu-jet® S / Pipetting controller accu-jet® S
Produktvarianten: Product variations:	Anthrazit, Beere, Petrol, Amethyst / anthracite, berry, petrol, amethyst
Art-Nr. / Cat.-No.	26350, 26351, 26352, 26353, 26360, 26361, 26362, 26363

Das oben beschriebene Produkt entspricht den grundlegenden Anforderungen, die in den nachfolgend bezeichneten Harmonisierungsrechtsvorschriften festgelegt sind: The product described above meets the basic requirements that are specified in the harmonization legislation listed below:	Angewendete harmonisierte Normen: Applied harmonized standards:
RoHS: 2011/65/EU incl.2015/863/EU EMC: 2014/30/EU	EN IEC 63000:2018 EN 61326-1:2013
Weitere angewendete Normen: Other applied standards:	Geltungsbereich: Scope:
EN 61010-1:2010, EN 61010-1:2010/A1:2019/AC:2019-04 EN/IEC 62368-1:2014 (angewendet auf Fremdherstellernetzteil / applied to third-party power supply)	NRL / LVD NRL / LVD

Die alleinige Verantwortung für die Ausstellung dieser Konformitätserklärung in Bezug auf die Erfüllung der grundlegenden Anforderungen und die Anfertigung der technischen Unterlagen trägt der Hersteller.

The manufacturer is solely responsible for issuing this declaration of conformity with regard to meeting the essential requirements and preparing the technical documentation.

Hersteller / Manufacturer	Adresse / Address
BRAND GMBH + CO KG	Otto-Schott-Str. 25 97877 Wertheim Germany

Wertheim, 01. Juli 2022 / 01 July 2022



Patrick Ziemeck
Managing Director Technology



i.A. Siegfried Ott
Regulatory Affairs

Diese Erklärung bescheinigt die Übereinstimmung mit den genannten Harmonisierungsvorschriften, beinhaltet jedoch keine Zusicherung von Eigenschaften.

This document declares the accordance with the named harmonized regulations, but does not assure specific properties.

UK Declaration of Conformity

Product name: Pipetting controller accu-jet® S
Product variations: anthracite, berry, petrol, amethyst
Cat.-No. 26350, 26351, 26352, 26353, 26360, 26361, 26362, 26363

The product described above meets the basic requirements that are specified in the harmonization legislation listed below:	Applied harmonized standards:
The Restriction of the Use of Certain Hazardous Substances in Electrical and Electronic Equipment Regulations 2012 (SI 2012 No. 3032)	EN IEC 63000:2018
Electromagnetic Compatibility Regulations 2016 (SI 2016 No. 1091, as amended by SI 2019 No. 696)	EN 61326-1:2013
Other applied standards:	Scope:
EN 61010-1:2010, EN 61010-1:2010/A1:2019/AC:2019-04 EN/IEC 62368-1:2014 (angewendet auf Fremdherstellernetzteil / applied to third-party power supply)	LVD LVD

The manufacturer is solely responsible for issuing this declaration of conformity with regard to meeting the essential requirements and preparing the technical documentation.

Manufacturer	Address
BRAND GMBH + CO KG	Otto-Schott-Str. 25 97877 Wertheim Germany

Wertheim, 18 February 2022



Patrick Ziemeck
Managing Director Technology



i.A. Siegfried Ott
Regulatory Affairs

This document declares the accordance with the named harmonized regulations, but does not assure specific properties.

Declaration of conformity – China RoHS 2

BRAND GMBH + CO KG has made reasonable efforts to ensure that hazardous materials and substances may not be used in BRAND products.

In order to determine the concentration of hazardous substances in all homogeneous materials of the subassemblies, a “Product Conformity Assessment” (PCA) procedure was performed. As defined in GB/T 26572 the “Maximum Concentration Value” limits (MCV) apply to these restricted substances:

+ Lead (Pb):	0.1%	+ Hexavalent chromium (Cr(+VI)):	0.1%
+ Mercury (Hg):	0.1%	+ Polybrominated biphenyls (PBB):	0.1%
+ Cadmium (Cd):	0.01%	+ Polybrominated diphenyl ether (PBDE):	0.1%

Environmental Friendly Use Period (EFUP)

EFUP defines the period in years during which the hazardous substances contained in electrical and electronic products will not leak or mutate under normal operating conditions. During normal use by the user such electrical and electronic products will not result in serious environmental pollution, cause serious bodily injury or damage to the user's assets.

The Environmental Friendly Use Period for BRAND instruments is 40 years.



Material Content Declaration for BRAND Products

部件名称 Part name	有毒有害物质或元素 Hazardous substances					
	铅 Pb	汞 Hg	镉 Cd	六价铬 Cr(+VI)	多溴联苯 PBB	多溴二苯醚 PBDE
包装 / Packaging	0	0	0	0	0	0
塑料外壳 / 组件 Plastic housing / parts	0	0	0	0	0	0
电池 / Battery	0	0	0	0	0	0
玻璃 / Glass	0	0	0	0	0	0
电子电气组件 Electrical and electronic parts	X	0	0	0	0	0
金属外壳 / 组件 Metal housing / parts	X	0	0	0	0	0
电机 / Motor	X	0	0	0	0	0
配件 / Accessories	X	0	0	0	0	0
此表格是按照SJ/T 11364-2014中规定所制定的。 This table is created according to SJ/T 11364-2014.						

- O: 表示该有毒有害物质在该部件所有均质材料中的含量均在GB/T 26572规定的限量要求以下。
- O: Indicates that the above mentioned hazardous substance contained in all homogeneous materials of the part is below the required limit as defined in GB/T 26572.
- X: 表示该有毒有害物质至少在该部件某一均质材料中的含量超出GB/T 26572规定的限量要求。
- X: Indicates that the above mentioned hazardous substance contained in at least one of the homogeneous materials of this part is above the required limit as defined in GB/T 26572.

注释： 电池，玻璃制品和配件可能不属于此设备的一部分且/或可能有它自己的EFUP标志且/或可能包含更改EFUP标志的部件。

Note: Batteries, glassware and accessories might not be content of the enclosed device and/or may have their own EFUP-marking and/or might be maintaining parts with changing EFUP-marking.

除上表所示信息外，还需声明的是，这些部件并非是有用铅 (Pb), 汞 (Hg), 镉 (Cd), 六价铬 (Cr(+VI)), 多溴联苯 (PBB) 或多溴二苯醚 (PBDE) 来制造的。

Apart from the disclosures in the above table, the subassemblies are not intentionally manufactured or formulated with lead (Pb), mercury (Hg), cadmium (Cd), hexavalent chromium (Cr+VI), polybrominated biphenyls (PBB), and polybrominated diphenyl ethers (PBDE).

Products manufactured by BRAND may enter into further devices or can be used together with other appliances. With these third party products and appliances in particular, please note the EFUP labeled on these products. BRAND will not take responsibility for the EFUP of those products and appliances.

Place, date: Wertheim, 05|04|2022



Patrick Ziemeck
(Managing Director Technology)



i.A. Siegfried Ott
(Regulatory Affairs)

Indice

1	Introduzione	143
1.1	Contenuto della fornitura	143
1.2	Destinazione d'uso.....	143
2	Sicurezza	145
2.1	Funzioni	146
2.2	Limiti di impiego	146
2.3	Usi non previsti.....	147
2.4	Condizioni per lo stoccaggio	147
3	Elementi di funzionamento e di comando	148
4	Messa in funzione	150
4.1	Collegare la batteria.....	150
4.2	Caricare la batteria.....	152
4.3	Avvio dello strumento.....	153
4.4	Selezionare la modalità operativa	153
4.5	Aspirare o erogare il liquido	154
4.6	Modificare la velocità di pipettaggio.....	154
4.7	Regolare il numero di giri del motore	154
4.8	Conservazione dello strumento	155
5	Aspirazione con pipetta.....	156
6	Pulizia	158
6.1	Controllare la tenuta.....	158
6.2	Sostituzione del filtro e pulizia dell'adattatore	159
6.3	Sterilizzazione UV.....	161
7	Problema - Cosa fare?	162
8	Dati tecnici.....	163
8.1	Marcatura sul prodotto.....	163

9 Riparazione.....	165
9.1 Invio al servizio riparazioni.....	165
10 Informazioni ordinazione	167
10.1 Strumento	167
10.2 Pezzi di ricambio	167
11 Garanzia	169
12 Smaltimento	170

1 Introduzione

1.1 Contenuto della fornitura

Controller per pipette, batteria al nichel-metallo idruro, alimentatore opzionale (notare i diversi numeri d'ordine), 2 filtri a membrana di ricambio da 0,2 µm, supporto da parete, istruzioni per l'uso

1.2 Destinazione d'uso





- Leggere attentamente le istruzioni per l'uso prima del primo utilizzo.
- Le istruzioni per l'uso sono parte dello strumento e devono essere conservate in modo da essere facilmente accessibili.
- Accludere queste istruzioni per l'uso quando si passa questo strumento a terzi.

1.2.1 Livelli di pericolo

I seguenti pittogrammi segnalano i possibili pericoli:

Pittogramma (parola chiave)	Significato
PERICOLO	Causa gravi lesioni o la morte.
AVVERTIMENTO	Può causare gravi lesioni o la morte.
ATTENZIONE	Può causare lesioni di lieve o media entità.
INDICAZIONE	Può causare danni materiali.

1.2.2 Simboli delle istruzioni per l'uso

Simbolo	Significato	Simbolo	Significato
	Punto di pericolo		Pericolo di esplosione
	Indossare occhiali di protezione		Indossare guanti di protezione

1.2.3 Rappresentazione

Rappresen- tazione	Significato	Rappresen- tazione	Significato
1. Task	Indica un compito da espletare.	>	Indica un presupposto da rispettare.
a., b., c.	Indica singoli passaggi di un compito.	⇒	Indica un risultato.

2 Sicurezza

Leggere attentamente prima dell'uso!

Lo strumento da laboratorio accu-jet® S può essere utilizzato con materiali, procedure di lavoro e apparecchiature pericolose. Le istruzioni per l'uso non possono però coprire tutte le eventuali problematiche di sicurezza che possono eventualmente presentarsi. È responsabilità dell'utilizzatore osservare adeguate prescrizioni per la sicurezza e la salute e definire prima dell'uso le opportune limitazioni.

1. Prima di utilizzare lo strumento, ogni utilizzatore è tenuto a leggere e osservare queste istruzioni per l'uso.
2. Osservare le avvertenze generali di pericolo e le norme di sicurezza. Ad esempio indossare indumenti di protezione, una protezione per gli occhi e guanti protettivi.
3. Rispettare le indicazioni del produttore dei reagenti.
4. Non utilizzare lo strumento in un'atmosfera a rischio di esplosioni e non pipettare sostanze facilmente infiammabili.
5. Utilizzare lo strumento esclusivamente per il pipettaggio di liquidi e tenere conto dei limiti e delle restrizioni nell'utilizzo. Rispettare gli usi non previsti, vedere Usi non previsti, p. 147 ! Nel dubbio, rivolgersi tassativamente al produttore o al distributore.
6. Operare sempre in modo che né l'utilizzatore né altre persone siano esposte a pericoli. Evitare spruzzi. Utilizzare soltanto recipienti adatti.
7. Non applicare mai forza eccessiva sullo strumento.
8. Utilizzare solo accessori originali e pezzi di ricambio originali. Non apportare modifiche tecniche. Non smontare ulteriormente lo strumento, oltre quanto descritto nelle istruzioni per l'uso!
9. Prima dell'uso controllare sempre che lo stato dello strumento sia regolare. Se si dovessero verificare anomalie dello strumento, interrompere immediatamente il pipettaggio e consultare il capitolo Störung - Was tun?. Eventualmente rivolgersi al produttore.

10. Per la ricarica delle batterie al nichel-metallo idruro utilizzare esclusivamente l'alimentatore originale.
11. La batteria non può essere scambiata con batterie di altri produttori.
12. L' alimentatore deve essere protetto dall'umidità e deve essere usato solo per questo strumento.
13. Cessare l'utilizzo dell'alimentatore se il cavo di allacciamento risulta danneggiato.
14. Le riparazioni e gli interventi sullo strumento possono essere effettuati solo da tecnici dell'assistenza autorizzati.

2.1 Funzioni

Lo strumento serve come ausilio per il dosaggio di liquidi con pipette graduate e tarate di vetro o plastica con un volume da 0,1 ml fino a 200 ml e con un diametro esterno del tubo di aspirazione < 9,2 mm. Con un utilizzo corretto dello strumento il liquido dosato viene a contatto solo con la pipetta.

2.2 Limiti di impiego

Lo strumento può essere utilizzato per il dosaggio di fluidi in osservanza delle seguenti limitazioni fisiche:

- da +10 °C a +40 °C (da 50 °F a 104 °F) (strumento e reagente)
- Tensione di vapore fino a max. 500 mbar. Sopra i 300 mbar aspirare lentamente, per evitare l'ebollizione del liquido.
- Densità fino a 9 g/cm³

2.3 Usi non previsti

Lo strumento non deve essere utilizzato con liquidi i cui vapori hanno effetto corrosivo o aggreiscono i materiali silicone o la gomma EPDM (monomero etilene-propilene diene).

Lo strumento non è adatto per l'utilizzo con pipette Pasteur.

AVVERTENZA!



Utilizzo dello strumento in ambienti a rischio di esplosione

Lo strumento non può essere utilizzato o caricato in ambienti a rischio di esplosione. Non possono essere pipettate sostanze facilmente infiammabili (punto di infiammabilità inferiore a 0°C (32 °F), ad esempio etere, acetone).

2.4 Condizioni per lo stoccaggio

Conservare l'apparecchio e gli accessori perfettamente puliti in un luogo fresco e asciutto.

Temperatura di immagazzinamento: da -20 °C a 50 °C (da -4 °F a 122 °F).

Umidità relativa dell'aria: dal 5 % al 95 %.

3 Elementi di funzionamento e di comando

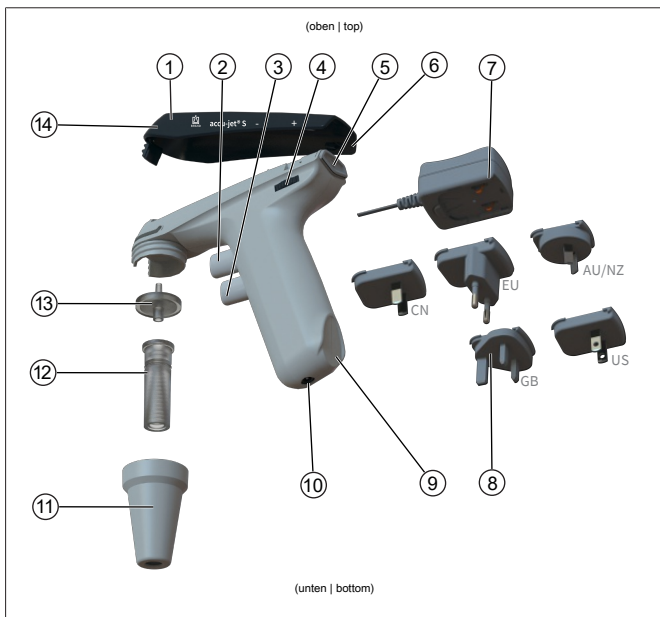

1 Guscio di alloggiamento superiore

3 Pulsante di pipettaggio inferiore (erogare il liquido)

5 Selettore della modalità operativa

7 Alimentatore

9 Superficie di appoggio impugnatura

11 Alloggiamento adattatore (PP)

13 Filtro a membrana (PP/PTFE)

2 Pulsante di pipettaggio superiore (raccolgere il liquido)

4 Rotella di regolazione per il numero di giri del motore

6 Superficie di appoggio del guscio di alloggiamento superiore

8 Adattatore per paese

10 Presa di ricarica

12 Adattatore/Valvola antiriflusso (SILICONE/PTFE - politetrafluoroetilene)

14 Apertura per la compensazione della pressione

Per le indicazioni relative a tensione e corrente assorbita vedere Dati tecnici, p. 163 .

Abbrev.	Materiale
PP	Polipropilene
PTFE	Politetrafluoroetilene
SI	Silicone

4 Messa in funzione

4.1 Collegare la batteria

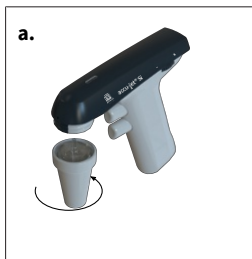

- a.** Svitare l'alloggiamento dell'adattatore. L'adattatore e il filtro rimangono nell'alloggiamento dell'adattatore.

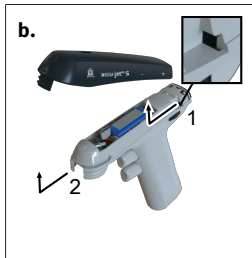

- b.** Rimuovere l'alloggiamento. Spostare l'alloggiamento leggermente in direzione del raccordo a vite dell'alloggiamento dell'adattatore.

⇒ L'alloggiamento si stacca dalle fessure sopra la rotella di regolazione (1) e dal raccordo a vite dell'alloggiamento dell'adattatore (2).

⇒ Il vano della batteria diventa visibile.

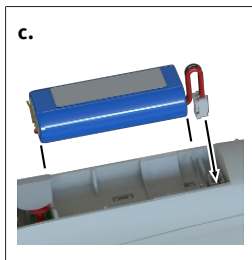

- c.** Mantenere il connettore della batteria dal cavo, orientarlo e inserirlo saldamente nella presa, fino a quando non si innesta in posizione in modo udibile. Inserire la batteria.

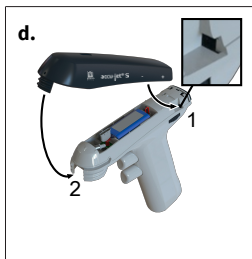

- d.** Inserire l'alloggiamento. A tal proposito verificare che l'alloggiamento si innesti nelle fessure previste sopra la rotella di regolazione (1) e nel raccordo a vite dell'alloggiamento dell'adattatore (2).

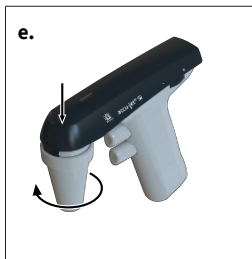

- e.** Spingere la parte superiore dell'alloggiamento nei gusci dell'alloggiamento e avvitare l'alloggiamento dell'adattatore.

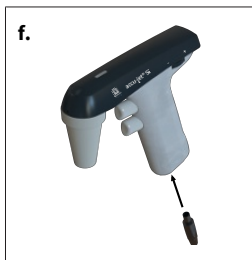

- f.** Caricare la batteria fino a quando l'indicatore di carica a LED non lampeggia in verde. Tempo di carica ca. 4 ore, vedere Caricare la batteria.

4.2 Caricare la batteria

⚠ AVVERTENZA!



Alimentatore o cavo di carica danneggiati

Pericolo di lesioni a seguito di folgorazione.



> Non utilizzare un alimentatore danneggiato.

> Se il cavo di carica è danneggiato, non utilizzare l'alimentatore.

AVVISO!

Utilizzare esclusivamente l'alimentatore originale del produttore!

L'impiego di un altro alimentatore può danneggiare lo strumento e la batteria.

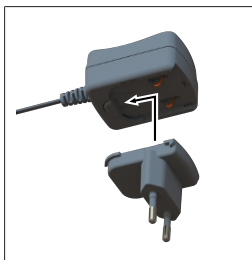

- a. Innestare l'adattatore per paese sull'alimentatore.
 - b. Collegare l'alimentatore allo strumento.
 - c. Inserire l'alimentatore nella spina di rete.
- ⇒ Lo strumento viene caricato. L'operazione di carica è rilevabile dall'indicatore a LED presente sulla parte superiore dell'alloggiamento. Per la durata di funzionamento e la durata della carica vedere i dati tecnici, p. 163.

Indicatore di carica a LED	Stato	Cosa fare?
Verde: lampeggiante	La batteria è carica. Si esegue una carica di mantenimento.	È possibile lavorare con lo strumento. Lo strumento è completamente carico.
Verde: accesso a luce fissa	La batteria si sta caricando	Si può continuare a lavorare anche durante la ricarica.
Rosso: lampeggiante	La batteria è quasi scarica.	Interrompere l'attività svolta con lo strumento.

Indicatore di carica a LED	Stato	Cosa fare?
		Ricaricare la batteria. Si può continuare a lavorare anche durante la ricarica.
Rosso: accesso a luce fissa	La batteria è scarica.	Ricaricare la batteria.

AVVISO!

- La carica di mantenimento impedisce il sovraccarico e riduce al minimo il cosiddetto lazy battery effect (effetto batteria pigra), simile all'effetto memoria. Questo effetto è il risultato di sovraccaricamenti ripetuti; il sintomo è che la batteria sembra essere completamente carica ma si scarica immediatamente dopo un brevissimo periodo di utilizzo. Per mantenere la capacità massima, ricaricare la batteria solo se questo viene visualizzato dall'indicatore e LED.

4.3 Avvio dello strumento

Lo strumento è pronto a funzionare quando è inserita una batteria carica. Non esiste un interruttore ON/OFF.

4.4 Selezionare la modalità operativa

Per il selettore vedere Elementi di funzionamento e di comando, p. 148 .

Modalità operativa “Dosaggio per gravità”: Spingere il selettore verso l'alto.

Modalità operativa “Soffiaggio con l'ausilio del motore” Spingere il selettore verso il basso.

4.5 Aspirare o erogare il liquido

Per il pulsante di pipettaggio vedere Elementi di funzionamento e di comando, p. 148

Per riempire la pipetta premere il pulsante di pipettaggio superiore e per erogare liquido premere invece il pulsante di pipettaggio inferiore.

4.6 Modificare la velocità di pipettaggio

La velocità viene limitata dal numero massimo impostato di giri del motore. Quanto più il pulsante di pipettaggio superiore o inferiore viene premuto, tanto più velocemente il liquido viene aspirato o erogato.

4.7 Regolare il numero di giri del motore

Per la rotella di regolazione vedere Elementi di funzionamento e di comando, p. 148

Il numero di giri del motore può essere regolato in modo continuo, da un massimo (+) ad un minimo (-), ruotando la rotella di regolazione. Consigliamo il numero massimo di giri del motore per pipette di grande volume e un numero di giri del motore più ridotto per pipette di piccolo volume.

4.8 Conservazione dello strumento

4.8.1 Appoggio su tavolo

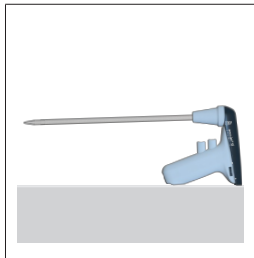

Il *accu-jet® S* può essere appoggiato su una superficie piana con la pipetta inserita.

4.8.2 Supporto a parete



- a. Pulire la superficie di fissaggio con un idoneo detergente (non un detergente ad uso domestico che contenga sostanze idratanti) e con un panno privo di pelucchi e poi lasciare che la superficie si asciughi bene.
- b. Togliere la pellicola protettiva dalla striscia adesiva
- c. Premere **saldamente** il supporto a parete sulla superficie di fissaggio.

5 Aspirazione con pipetta

1. Innestare la pipetta

⚠ AVVERTENZA!



Assicurarsi della salda sede della pipetta. Non applicare mai forza eccessiva! Sussiste il pericolo di rottura del vetro, in particolare in caso di pipette sottili! Pericolo di lesioni!

1.

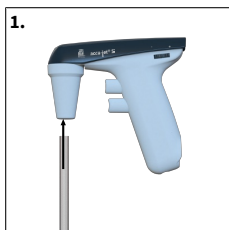

- a. Afferrare la pipetta il più possibile vicino all'estremità superiore e inserirla con cautela nell'adattatore, fino a che è saldamente fissata.
- b. Tenere lo strumento con la pipetta inserita sempre in verticale e con la punta rivolta verso il basso.

2. Riempire la pipetta

2.

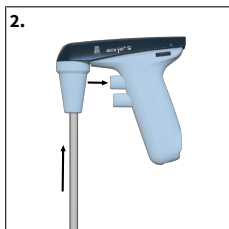

- a. Immergere la punta della pipetta nel liquido.
- b. Premere lentamente il pulsante di pipettaggio superiore e riempire la pipetta in modo tale che il menisco si venga a trovare leggermente al di sopra del segno di graduazione desiderato.
- c. Se si premono entrambi i pulsanti di pipettaggio si può aspirare o erogare un liquido in modo molto sensibile.

Questo risulta particolarmente utile quando si regola il menisco o si utilizzano pipette con piccoli volumi.

AVVISO!

Non riempire eccessivamente la pipetta.

3. Regolazione del volume

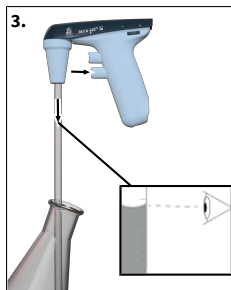

- a. Se necessario, pulire la punta della pipetta con un panno adatto privo di pelucchi.
- b. Premere lentamente il pulsante di pipettaggio inferiore e fare defluire il liquido fino a quando il menisco si posiziona esattamente sulla graduazione desiderata.

4. Svuotare la pipetta

- a. Premere lentamente il pulsante inferiore di pipettaggio. La velocità di pipettaggio dipende da quanto vengono premuti i pulsanti di pipettaggio. Nella modalità operativa “Soffiaggio con l’ausilio del motore” la velocità dipende anche dal numero di giri del motore che è stato impostato

5. Dopo il pipettaggio

- a. Afferrare la pipetta quanto più possibile in alto ed estrarla dall’adattatore.

6 Pulizia

AVVISO!

accu-jet® S non è sterilizzabile in autoclave

Pulire occasionalmente i componenti dell'alloggiamento con un panno umido. Con un utilizzo conforme, lo strumento non necessita di manutenzione.

6.1 Controllare la tenuta

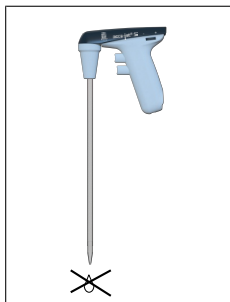

Dopo la regolazione del menisco e senza azionare le valvole non deve fuoriuscire del liquido dalla pipetta. Nel caso in cui la pipetta goccioli, vedere Störung - Was tun?

6.2 Sostituzione del filtro e pulizia dell'adattatore

⚠ AVVERTENZA!



Pericolo di contaminazione e di infezione

Indossare guanti e occhiali di protezione.



AVVISO!

La sostituzione o la pulizia sono necessarie soltanto nel caso in cui una pipetta sia stata riempita troppo o se la potenza di aspirazione è compromessa.

b.



- a.** Estrarre la pipetta.
- b.** Svitare l'alloggiamento dell'adattatore.
- c.** Estrarre l'alloggiamento superiore.

d.



- d.** Spingere all'esterno l'adattatore e il filtro a membrana dal lato affusolato dell'alloggiamento dell'adattatore

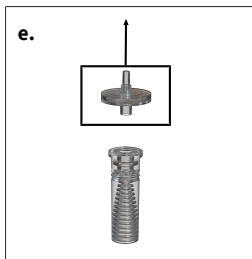

- e.** Rimuovere il filtro a membrana difettoso.

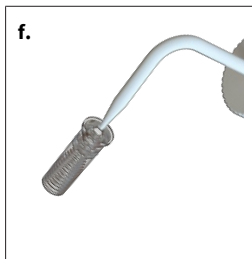

- f.** Per pulire l'adattatore, sciacquarlo accuratamente con l'aiuto di uno spruzzino riempito con un liquido detergente adatto, ad es. acqua. Successivamente soffiare con aria e asciugarlo.

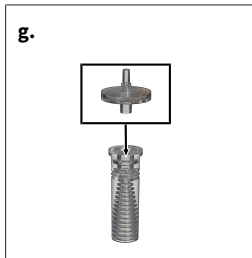

- g.** Inserire, premendo, il nuovo filtro a membrana con l'estremità più spessa rivolta in basso, prima nell'adattatore (il lato più sottile e conico deve essere rivolto verso l'alto) e poi nell'alloggiamento dell'adattatore.

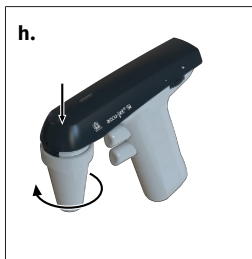

- h.** Spingere la parte superiore dell'alloggiamento nei gusci dell'alloggiamento e avvitare l'alloggiamento dell'adattatore.

AVVISO!

Indicazione sui filtri sterilizzabili in autoclave

È responsabilità dell'utente controllare l'efficacia della sterilizzazione in autoclave. Non tutti i filtri a membrana sono adatti! Utilizzare solo accessori originali.

- > Lo strumento è equipaggiato di serie con un filtro a membrana da 0,2 μm (codice colore rosso).
- > Il filtro a membrana può essere sterilizzato in autoclave per cinque volte a 121 °C (250 °F).
- > Con un filtro a membrana da 0,2 μm (per coltura cellulare) si possono raggiungere delle tolleranze sul volume di classe B.
- > Per rispettare le tolleranze di volume della classe A sono necessari dei filtri a membrana da 3 μm A causa della maggiore larghezza dei pori questi filtri hanno un'influenza minore sul tempo di dosaggio per gravità delle pipette, vedere .

6.3 Sterilizzazione UV

Lo strumento resiste alla normale sollecitazione di una lampada di sterilizzazione a raggi UV. L'azione degli ultravioletti può causare una variazione di colore.

7 Problema - Cosa fare?



Problema	Causa	Cosa fare?
Potenza di aspirazione compromessa	Il numero di giri del motore è ridotto	Aumentare il numero di giri del motore, vedere Regolare il numero di giri del motore, p. 154 .
	Valvola antiritorno chiusa	Posizionare il selettore sul soffiaggio e premere il pulsante di pipettaggio inferiore, vedere Selezionare la modalità operativa, p. 153
La pipetta gocciola	Il filtro non è inserito correttamente	Inserire il filtro correttamente, vedere Sostituire il filtro e pulire l'adattatore, p. 159 .
	Adattatore o pipetta danneggiati	Sostituire l'adattatore o la pipetta, vedere Sostituire il filtro e pulire l'adattatore, p. 159 .
La pipetta non rimane fissa nell'adattatore	Adattatore sporco o danneggiato	Pulire l'adattatore, asciugarlo all'aria, se necessario sostituirlo, vedere Sostituire il filtro e pulire l'adattatore, p. 159 .
L'indicatore di carica a LED non si illumina/non lampeggia dopo che l'alimentatore è stato collegato e si è attivata l'alimentazione di tensione.	Il connettore della batteria non è inserito saldamente	Inserire saldamente il connettore della batteria, vedere Collegare la batteria, p. 150
	Alimentatore sbagliato	Utilizzare solo l'alimentatore originale, vedere Elementi di funzionamento e di comando, p. 148
	Batteria o alimentatore difettoso	Sostituire la batteria/l'alimentatore
	Strumento difettoso	Inviare lo strumento al servizio riparazioni, vedere Riparazione, p. 165
Scarsa capacità della batteria	Batteria difettosa	Sostituire la batteria, vedere Collegare la batteria, p. 150 .
Lo strumento non mostra alcuna funzione	Errore interno (eseguire un reset)	Staccare il connettore della batteria e mantenere premuto un pulsante di pipettaggio per 10 sec. Poi reinserire saldamente il connettore della batteria, vedere Collegare la batteria, p. 150 e Aspirazione con pipetta, p. 156

Se non è possibile risolvere il problema con l'ausilio della tabella dei guasti sopra riportata, rivolgersi al proprio rivenditore specializzato o direttamente al produttore.

8 Dati tecnici

Dati tecnici	Valori
Presa di ricarica	5 VCC
Alimentatore	Ingresso: 100 – 240 VCA, 50/60 Hz Uscita: 5 VCC
Batteria	Gruppo batterie NiMH 2,4 V, 730 mAh Tempo di carica: 4 h Massima durata di funzionamento: ca. 8 h Temperatura di carica: da +10 °C fino a +35 °C

8.1 Marcatura sul prodotto

Simbolo o numero	Significato
XXZXXXXX	Numero di serie
Codice QR	Contiene il numero di serie
	Con questa sigla confermiamo che il prodotto soddisfa i requisiti definiti nelle direttive CE e che è stato sottoposto alle procedure di prova stabilite.
	Marchio UKCA: United Kingdom Conformity Assessed (Conformità valutata del Regno Unito) Con questo marchio confermiamo che il prodotto soddisfa i requisiti definiti dagli UK Designated Standards.
www.brand.de/ip	Informazioni sul brevetto
 (in questo caso: 40 anni)	L'etichetta EFUP (Environment Friendly Use Period - Periodo d'uso ecosostenibile) prevista dal regolamento cinese China RoHS (Restrictions of Hazardous Substances - Restrizioni sulle sostanze pericolose) EFUP definisce il periodo, espresso in anni, in cui le sostanze pericolose contenute nelle apparecchiature elettriche ed elettroniche, in presenza di normali condizioni di esercizio, non fuoriescono né subiscono variazioni. In caso di normale utilizzo da parte dell'utente, tali prodotti elettrici ed elettronici non causano un grave inquinamento ambientale, né serie lesioni corporali o danni ai beni materiali dell'utente.

Simbolo o numero	Significato
	Lo strumento elettrico non deve essere smaltito con i rifiuti domestici.

9 Riparazione

9.1 Invio al servizio riparazioni

AVVISO!

La legge vieta il trasporto di merci pericolose senza autorizzazione.

Pulire e decontaminare accuratamente lo strumento!

- Allegare al reso di prodotti una descrizione precisa del tipo di problema e delle sostanze utilizzate. Se non si indicano le sostanze utilizzate, lo strumento non può essere riparato.
- Spedire lo strumento esclusivamente senza accumulatore (batteria ricaricabile) o senza batteria non ricaricabile.
- La restituzione avviene a rischio e spese del mittente.

Fuori dagli Stati Uniti e dal Canada

Compilare la 'Dichiarazione di assenza di rischi per la salute' ed inviarla con lo strumento al distributore o al produttore. I moduli possono essere richiesti al distributore o al produttore, oppure si possono scaricare dal sito www.brand.de.

All'interno degli Stati Uniti e del Canada

Si invita a chiarire i prerequisiti per la restituzione con BrandTech Scientific, Inc. **prima** di inviare lo strumento al servizio di assistenza.

Inviare solo strumenti puliti e decontaminati all'indirizzo che avete ricevuto insieme al numero di reso. Applicare il numero di reso bene in vista sull'esterno del pacco.

Indirizzi di contatto

Germania:

BRAND GMBH + CO KG
Otto-Schott-Straße 25
97877 Wertheim (Germania)
T +49 9342 808 0
F +49 9342 808 98000
info@brand.de
www.brand.de

Stati Uniti e Canada:

BrandTech® Scientific, Inc.
11 Bokum Road
Essex, CT 06426-1506 (USA)
T +1 -860 -767 2562
F +1 -860 -767 2563
info@brandtech.com
www.brandtech.com

India:

BRAND Scientific Equipment Pvt. Ltd.
303, 3rd Floor, 'C' Wing, Delphi
Hiranandani Business Park,
Powai
Mumbai - 400 076 (India)
T +91 22 42957790
F +91 22 42957791
info@brand.co.in
www.brand.co.in

Cina:

BRAND (Shanghai) Trading Co., Ltd.
Guangqi Culture Plaza
Room 506, Building B
No. 2899, Xietu Road
Shanghai 200030 (Repubblica Popolare di Cina)
T +86 21 6422 2318
F +86 21 6422 2268
info@brand.com.cn
www.brand.cn.com

10 Informazioni ordinazione

10.1 Strumento

Colore della parte superiore dell'alloggiamento	N° ord. (con alimentatore universale e adattatore per paese)	N° ord. (Senza alimentatore universale e senza adattatore per paese)
Antracite	26350	26360
Violaceo	26351	26361
Petrolino	26352	26362
Ametista	26353	26363

Per il contenuto della fornitura vedere Prestare attenzione ai numeri di ordinazione, con o senza alimentatore.

10.2 Pezzi di ricambio

Filtro a membrana sostitutivo

Descrizione	Unità di confezionam.	N° ord.
0,2 µm, sterile (codice colore rosso)	1 pz. in confezione blister	26530
0,2 µm	10 pezzi in un sacchetto di PE	26535
3 µm	1 pz. in confezione blister	26052
3 µm	10 pezzi in un sacchetto di PE	26056

Alimentatore

Per i dati tecnici relativi all'alimentatore, vedere Dati tecnici, p. 163.

Tipo	N° ord.
Alimentatore con adattatore per paese	26606

Gruppo batterie

Per i dati tecnici relativi alla batteria, vedere Dati tecnici, p. 163 .

Descrizione	N° ord.
Gruppo batterie NiMH	26630

Adattatore di silicone con valvola antiritorno

Descrizione	N° ord.
Adattatore di silicone	26508

Alloggiamento dell'adattatore

Colore	N° ord.
bianco	26658

Supporto a parete

Colore	N° ord.
bianco	26539

Striscia adesiva

Unità di confezionam.	N° ord.
3 set	26547

11 Garanzia

Non ci assumiamo alcuna responsabilità per le conseguenze di manipolazione, uso, manutenzione e impiego non corretti, o per riparazioni non autorizzate dello strumento o per le conseguenze del normale consumo, in particolare dei componenti soggetti ad usura, come ad esempio pistoni, guarnizioni e valvole, e in caso di rottura del vetro. Lo stesso vale per la mancata osservanza delle istruzioni per l'uso. In particolare non ci assumiamo alcuna responsabilità per danni derivanti da un ulteriore smontaggio dello strumento, al di là di quello previsto nelle istruzioni per l'uso, o se vengono montati accessori o parti di ricambio non originali.

Stati Uniti e Canada:

Per informazioni sulla garanzia consultare il sito www.brandtech.com.

12 Smaltimento



Il simbolo qui accanto significa che le batterie/batterie ricaricabili e i dispositivi elettronici devono essere smaltiti separatamente dai rifiuti domestici (rifiuti urbani non differenziati) alla fine della loro durata di utilizzo.

I dispositivi elettronici devono essere smaltiti correttamente in conformità alla direttiva 2012/19/UE del Parlamento europeo e del Consiglio del 04 luglio 2012 sulle apparecchiature elettriche ed elettroniche in conformità alle norme nazionali di smaltimento.

Le batterie e gli accumulatori contengono sostanze che possono avere effetti nocivi sull'ambiente e sulla salute umana. Devono quindi essere smaltiti correttamente in conformità alle normative nazionali sullo smaltimento dei rifiuti secondo la direttiva 2006/66/CE del Parlamento europeo e del Consiglio del 6 settembre 2006 su pile e accumulatori. Smaltire solo batterie e accumulatori completamente scarichi.

EU-Konformitätserklärung | EU Declaration of Conformity

Produktbezeichnung: Product name:	Pipettierhelfer accu-jet® S / Pipetting controller accu-jet® S
Produktvarianten: Product variations:	Anthrazit, Beere, Petrol, Amethyst / anthracite, berry, petrol, amethyst
Art-Nr. / Cat.-No.	26350, 26351, 26352, 26353, 26360, 26361, 26362, 26363

Das oben beschriebene Produkt entspricht den grundlegenden Anforderungen, die in den nachfolgend bezeichneten Harmonisierungsrechtsvorschriften festgelegt sind: The product described above meets the basic requirements that are specified in the harmonization legislation listed below:	Angewendete harmonisierte Normen: Applied harmonized standards:
RoHS: 2011/65/EU incl.2015/863/EU EMC: 2014/30/EU	EN IEC 63000:2018 EN 61326-1:2013
Weitere angewendete Normen: Other applied standards:	Geltungsbereich: Scope:
EN 61010-1:2010, EN 61010-1:2010/A1:2019/AC:2019-04 EN/IEC 62368-1:2014 (angewendet auf Fremdherstellernetzteil / applied to third-party power supply)	NRL / LVD NRL / LVD

Die alleinige Verantwortung für die Ausstellung dieser Konformitätserklärung in Bezug auf die Erfüllung der grundlegenden Anforderungen und die Anfertigung der technischen Unterlagen trägt der Hersteller.

The manufacturer is solely responsible for issuing this declaration of conformity with regard to meeting the essential requirements and preparing the technical documentation.

Hersteller / Manufacturer	Adresse / Address
BRAND GMBH + CO KG	Otto-Schott-Str. 25 97877 Wertheim Germany

Wertheim, 01. Juli 2022 / 01 July 2022



Patrick Ziemeck
Managing Director Technology



i.A. Siegfried Ott
Regulatory Affairs

Diese Erklärung bescheinigt die Übereinstimmung mit den genannten Harmonisierungsvorschriften, beinhaltet jedoch keine Zusicherung von Eigenschaften.

This document declares the accordance with the named harmonized regulations, but does not assure specific properties.

UK Declaration of Conformity

Product name: Pipetting controller accu-jet® S
Product variations: anthracite, berry, petrol, amethyst
Cat.-No. 26350, 26351, 26352, 26353, 26360, 26361, 26362, 26363

The product described above meets the basic requirements that are specified in the harmonization legislation listed below:	Applied harmonized standards:
The Restriction of the Use of Certain Hazardous Substances in Electrical and Electronic Equipment Regulations 2012 (SI 2012 No. 3032)	EN IEC 63000:2018
Electromagnetic Compatibility Regulations 2016 (SI 2016 No. 1091, as amended by SI 2019 No. 696)	EN 61326-1:2013
Other applied standards:	Scope:
EN 61010-1:2010, EN 61010-1:2010/A1:2019/AC:2019-04 EN/IEC 62368-1:2014 (angewendet auf Fremdherstellernetzteil / applied to third-party power supply)	LVD LVD

The manufacturer is solely responsible for issuing this declaration of conformity with regard to meeting the essential requirements and preparing the technical documentation.

Manufacturer	Address
BRAND GMBH + CO KG	Otto-Schott-Str. 25 97877 Wertheim Germany

Wertheim, 18 February 2022



Patrick Ziemeck
Managing Director Technology



i.A. Siegfried Ott
Regulatory Affairs

This document declares the accordance with the named harmonized regulations, but does not assure specific properties.

Declaration of conformity – China RoHS 2

BRAND GMBH + CO KG has made reasonable efforts to ensure that hazardous materials and substances may not be used in BRAND products.

In order to determine the concentration of hazardous substances in all homogeneous materials of the subassemblies, a “Product Conformity Assessment” (PCA) procedure was performed. As defined in GB/T 26572 the “Maximum Concentration Value” limits (MCV) apply to these restricted substances:

+ Lead (Pb):	0.1%	+ Hexavalent chromium (Cr(+VI)):	0.1%
+ Mercury (Hg):	0.1%	+ Polybrominated biphenyls (PBB):	0.1%
+ Cadmium (Cd):	0.01%	+ Polybrominated diphenyl ether (PBDE):	0.1%

Environmental Friendly Use Period (EFUP)

EFUP defines the period in years during which the hazardous substances contained in electrical and electronic products will not leak or mutate under normal operating conditions. During normal use by the user such electrical and electronic products will not result in serious environmental pollution, cause serious bodily injury or damage to the user's assets.

The Environmental Friendly Use Period for BRAND instruments is 40 years.



Material Content Declaration for BRAND Products

部件名称 Part name	有毒有害物质或元素 Hazardous substances					
	铅 Pb	汞 Hg	镉 Cd	六价铬 Cr(+VI)	多溴联苯 PBB	多溴二苯醚 PBDE
包装 / Packaging	0	0	0	0	0	0
塑料外壳 / 组件 Plastic housing / parts	0	0	0	0	0	0
电池 / Battery	0	0	0	0	0	0
玻璃 / Glass	0	0	0	0	0	0
电子电气组件 Electrical and electronic parts	X	0	0	0	0	0
金属外壳 / 组件 Metal housing / parts	X	0	0	0	0	0
电机 / Motor	X	0	0	0	0	0
配件 / Accessories	X	0	0	0	0	0
此表格是按照SJ/T 11364-2014中规定所制定的。 This table is created according to SJ/T 11364-2014.						

- O: 表示该有毒有害物质在该部件所有均质材料中的含量均在GB/T 26572规定的限量要求以下。
O: Indicates that the above mentioned hazardous substance contained in all homogeneous materials of the part is below the required limit as defined in GB/T 26572.
- X: 表示该有毒有害物质至少在该部件某一均质材料中的含量超出GB/T 26572规定的限量要求。
X: Indicates that the above mentioned hazardous substance contained in at least one of the homogeneous materials of this part is above the required limit as defined in GB/T 26572.

注释： 电池，玻璃制品和配件可能不属于此设备的一部分且/或可能有它自己的EFUP标志且/或可能包含更改EFUP标志的部件。

Note: Batteries, glassware and accessories might not be content of the enclosed device and/or may have their own EFUP-marking and/or might be maintaining parts with changing EFUP-marking.

除上表所示信息外，还需声明的是，这些部件并非是有用铅 (Pb), 汞 (Hg), 镉 (Cd), 六价铬 (Cr(+VI)), 多溴联苯 (PBB) 或多溴二苯醚 (PBDE) 来制造的。

Apart from the disclosures in the above table, the subassemblies are not intentionally manufactured or formulated with lead (Pb), mercury (Hg), cadmium (Cd), hexavalent chromium (Cr+VI), polybrominated biphenyls (PBB), and polybrominated diphenyl ethers (PBDE).

Products manufactured by BRAND may enter into further devices or can be used together with other appliances. With these third party products and appliances in particular, please note the EFUP labeled on these products. BRAND will not take responsibility for the EFUP of those products and appliances.

Place, date: Wertheim, 05|04|2022



Patrick Ziemeck
(Managing Director Technology)



i.A. Siegfried Ott
(Regulatory Affairs)

1	Introdução	177
1.1	Escopo de entrega.....	177
1.2	Regras de utilização	177
2	Segurança	179
2.1	Função	180
2.2	Limites de aplicação	180
2.3	Exclusões de aplicação	180
2.4	Condições de armazenamento	181
3	Elementos de funções e de comando	182
4	Colocação em funcionamento	184
4.1	Ligar a bateria.....	184
4.2	Carregar bateria	186
4.3	Iniciar dispositivo	187
4.4	Selecionar o modo de funcionamento	187
4.5	Absorver ou dispensar líquido.....	187
4.6	Alterar a velocidade de pipetagem	188
4.7	Ajustar a rotação do motor.....	188
4.8	Armazenamento do dispositivo	189
5	Pipetagem	190
6	Limpeza	192
6.1	Verificar a estanqueidade	192
6.2	Substituir o filtro e limpar o adaptador	192
6.3	Desinfecção UV.....	195
7	Avaria - O que fazer?	196
8	Dados técnicos	197
8.1	Identificação no produto	197

9	Reparação.....	198
9.1	Enviar para reparação.....	198
10	Informações sobre a encomenda.....	200
10.1	Dispositivo	200
10.2	Peças de reposição	200
11	Responsabilidade por defeitos.....	202
12	Eliminação	203

1 Introdução

1.1 Escopo de entrega

Controlador de pipetas, bateria de níquel-hidreto metálico, fonte de alimentação opcional (observe os números de encomenda diferentes), 2 filtros de membrana sobressalentes 0,2 µm, suporte de parede, manual de utilização

1.2 Regras de utilização





- Leia cuidadosamente o manual de instruções antes da primeira utilização.
- O manual de instruções faz parte do dispositivo e deve ser mantido facilmente acessível.
- Se entregar o dispositivo a terceiros, inclua também o manual de instruções.

1.2.1 Níveis de perigo

As seguintes palavras-chave identificam possíveis perigos:

Palavra-chave	Significado
PERIGO	Causa ferimentos graves ou a morte.
AVISO	Pode causar ferimentos graves ou a morte.
CUIDADO	Pode causar ferimentos ligeiros ou moderados.
NOTA	Pode causar danos materiais.

1.2.2 Símbolos do manual de instruções

Símbolo	Significado	Símbolo	Significado
	Área de perigo		Perigo de explosão
	Usar proteção ocular		Usar luvas de proteção

1.2.3 Representação

Representação	Significado	Representação	Significado
1. Task	Identifica uma tarefa.	>	Identifica um requisito.
a., b., c.	Identifica passos individuais da tarefa.	⇒	Identifica um resultado.

2 Segurança

Por favor, leia com atenção!

O dispositivo do laboratório accu-jet® S pode ser utilizado em combinação com materiais, operações e equipamento perigosos. No entanto, o manual de instruções não pode mostrar todos os problemas de segurança que possam ocorrer. É da responsabilidade do utilizador assegurar o cumprimento das prescrições segurança e de saúde e determinar as restrições apropriadas antes da utilização.

1. Cada utilizador deve ler e respeitar estas instruções de utilização antes de utilizar o aparelho.
2. Seguir as indicações de perigo gerais e prescrições de segurança, por ex., usar vestuário de proteção, proteção ocular e luvas de proteção.
3. Seguir as instruções do fabricante do reagente.
4. Não operar o dispositivo em atmosferas explosivas e não pipetar meios altamente inflamáveis.
5. Utilizar o aparelho apenas para a pipetagem de líquidos e apenas dentro dos limites de aplicação definidos. Observar as exclusões de utilização, ver Exclusões de aplicação, S. 180 ! Em caso de dúvida, contactar o fabricante ou o distribuidor.
6. Trabalhar sempre de modo a não ameaçar a segurança do utilizador nem a de outras pessoas. Evitar respingos. Utilizar apenas recipientes adequados.
7. Nunca utilizar a força.
8. Utilizar apenas acessórios originais e peças sobressalentes originais. Não realizar quaisquer alterações técnicas. Não desmontar o aparelho para além do descrito nas instruções de utilização!
9. Verificar sempre se o aparelho está em bom estado antes da utilização. Se notar alguma avaria no funcionamento do dispositivo, pare imediatamente de pipetar e siga o capítulo Avaria- O que fazer? . Se necessário, dirija-se ao fabricante.
10. Apenas a fonte de alimentação original pode ser utilizada para carregar a bateria de níquel-hidreto metálico.

11. A bateria não pode ser trocada por baterias de outros fabricantes.
12. A fonte de alimentação deve ser protegida da humidade e só pode ser utilizada em conjunto com este dispositivo.
13. Não utilizar a fonte de alimentação se o cabo de ligação estiver danificado.
14. As reparações e intervenções no dispositivo só podem ser efetuadas por técnicos de serviço autorizados.

2.1 Função

O dispositivo é utilizado como auxiliar na pipetagem de líquidos com pipetas graduadas e volumétricas feitas de vidro ou plástico na gama de volume de 0,1 ml até 200 ml e com um tubo de sucção de diâmetro exterior < 9,2 mm. Em caso de manuseamento correto, o líquido pipetado entra em contato apenas com a pipeta.

2.2 Limites de aplicação

O aparelho é utilizado para pipetar líquidos sob a consideração dos seguintes limites físicos:

- de +10 °C até +40 °C (de 50 °F até 104 °F) (aparelho e reagente)
- Pressão do vapor até no máx. 500 mbar. Absorver lentamente acima de 300 mbar para evitar a ebulição do líquido.
- Densidade até 9 g/cm³

2.3 Exclusões de aplicação

O dispositivo não deve ser utilizado para líquidos cujos vapores tenham um efeito corrosivo ou ataquem os materiais silicone ou EPDM.

O dispositivo não é adequado para a utilização com pipetas de Pasteur.

AVISO



Funcionamento do dispositivo num ambiente explosivo

O dispositivo não deve ser operado ou carregado num ambiente explosivo. Nenhum meio altamente inflamável pode ser pipetado (ponto de inflamação abaixo de 0 °C (32 °F), por exemplo, éter, acetona).

2.4 Condições de armazenamento

Armazenar o aparelho e os acessórios apenas enquanto limpos em local fresco e seco.

Temperatura de armazenamento: de -20 °C até + 50 °C (de -4 °F até 122 °F).

Humidade relativa do ar: 5 % até 95 %.

3 Elementos de funções e de comando

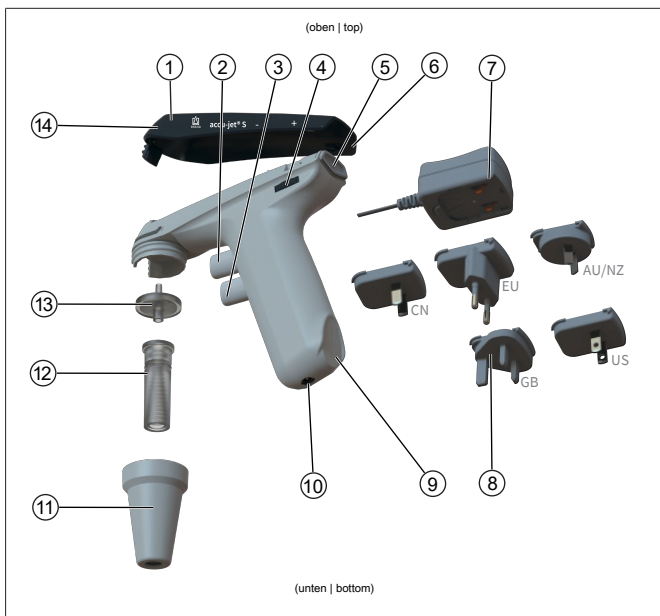

- | | | | |
|----|---|----|--|
| 1 | Carcaça superior da caixa | 2 | Botão de pipetagem superior (absorver o líquido) |
| 3 | Botão de pipetagem inferior (dispensar o líquido) | 4 | Roda de ajuste para rotação do motor |
| 5 | Interruptor seletor para modo de funcionamento | 6 | Espaço de armazenamento da carcaça superior da caixa |
| 7 | Fonte de alimentação | 8 | Adaptador de país |
| 9 | Espaço de armazenamento pega | 10 | Tomada de carregamento |
| 11 | Caixa do adaptador (PP) | 12 | Adaptador/Válvula de retenção (SI/PTFE) |
| 13 | Filtro de membrana (PP/PTFE) | 14 | Abertura de igualização de pressão |

Informações sobre tensão e consumo de corrente, ver Dados técnicos, S. 197 .

Abrev.	Material
PP	Polipropileno
PTFE	Politetrafluoretileno
SI	Silicone

4 Colocação em funcionamento

4.1 Ligar a bateria

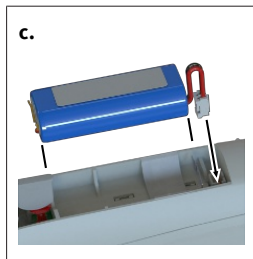
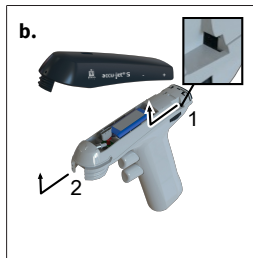
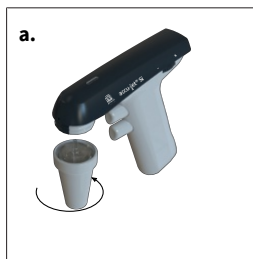

- a.** Desparafusar a caixa do adaptador. O adaptador e o filtro permanecem na caixa do adaptador.

- b.** Retirar a caixa. Empurrar ligeiramente a caixa para a ligação roscada da caixa do adaptador.

⇒ A caixa sai das reentrâncias acima da roda de ajuste (1) e da união roscada da caixa do adaptador (2).

⇒ O compartimento da bateria torna-se visível.

- c.** Segure a ficha da bateria pelo cabo, alinhe-a em conformidade e insira-a firmemente na tomada até que ela encaixe de forma audível. Inserir a bateria.

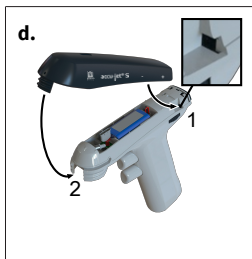

- d.** Inserir a caixa. Certificar-se de que a caixa encaixa nas reentrâncias fornecidas acima da roda de ajuste (1) e na ligação roscada da caixa do adaptador (2).

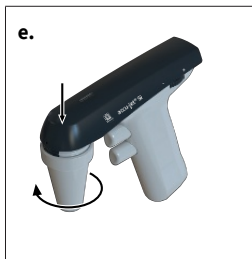

- e.** Pressionar a parte superior da carcaça para dentro das carcaças da caixa e aparafusar na carcaça do adaptador.

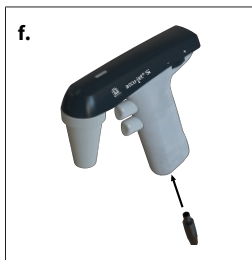

- f.** Carregue a bateria até o indicador LED de carga piscar a verde. Tempo de carregamento de aproximadamente 4 horas, ver Carregar bateria.

4.2 Carregar bateria

⚠ AVISO



Adaptador de rede ou cabo de carregamento danificado

Risco de ferimentos por choque elétrico.



- > Não utilizar um adaptador de rede danificado.
- > Se o cabo de carregamento estiver danificado, não utilizar a fonte de alimentação.

NOTA

Utilize apenas o adaptador de rede original do fabricante!

A utilização de uma fonte de alimentação diferente pode danificar o dispositivo e a bateria.

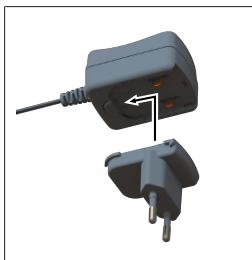

- a. Ligar o adaptador do país á fonte de alimentação.
 - b. Ligar a fonte de alimentação à máquina.
 - c. Ligar a fonte de alimentação à tomada principal.
- ⇒ O dispositivo está a carregar. Isto pode ser reconhecido pelo indicador de carga LED na parte superior da caixa. Para tempo de funcionamento e tempo de carregamento, ver Dados técnicos, S. 197 .

Indicador de carga LED	Estado	O que fazer?
Verde: a piscar	A bateria está carregada. É realizada uma cobrança por gota de água.	Pode trabalhar com o dispositivo. O dispositivo está totalmente carregado.
Verde: permanentemente iluminado	Bateria a carregar	Pode continuar a trabalhar enquanto a bateria está a carregar.

Indicador de carga LED	Estado	O que fazer?
Vermelho: a piscar	A bateria está quase descarregada.	Interrompa a sua actividade com o dispositivo. Carregue a bateria. Pode continuar a trabalhar enquanto a bateria está a carregar.
Vermelho: permanentemente iluminado	A bateria está descarregada.	Carregue a bateria.

NOTA

- O carregamento lento evita a sobrecarga e minimiza o efeito da bateria preguiçosa. Para manter a capacidade máxima, não recarregar a bateria até ser indicado pelo indicador de carga LED.

4.3 Iniciar dispositivo

O dispositivo está pronto para funcionar quando uma bateria carregada é inserida. Não há interruptor ON/OFF.

4.4 Selecionar o modo de funcionamento

Interruptor seletor, ver Elementos de funções e de comando, S. 182.

Modo de operação "drenagem livre": Empurre o interruptor seletor para cima.

Modo de funcionamento "Sopro com apoio do motor": Empurre o interruptor seletor para baixo.

4.5 Absorver ou dispensar líquido

Botão de pipetagem, ver Elementos de funções e de comando, S. 182

Pressione o botão de pipetagem superior para encher a pipeta e o botão de pipetagem inferior para dispensar.

4.6 Alterar a velocidade de pipetagem

A velocidade é limitada pela velocidade máxima do motor definida. Quanto mais se pressiona o botão de pipetagem superior ou inferior, mais rápido o líquido é aspirado ou dispensado.

4.7 Ajustar a rotação do motor

Roda de ajuste, ver Elementos de funções e de comando, S. 182

A rotação do motor pode ser ajustada continuamente do máximo (+) ao mínimo (-), rodando a roda de ajuste. Recomendamos a rotação máxima do motor para pipetas de grande volume e uma rotação mais baixa do motor para pipetas de pequeno volume.

4.8 Armazenamento do dispositivo

4.8.1 Tabuleiro de mesa

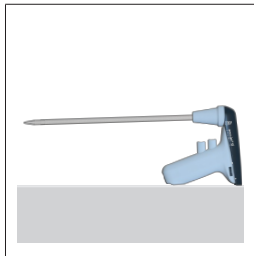

O accu-jet® S pode ser colocado sobre uma superfície plana com a pipeta inserida.

4.8.2 Suporte de parede



- Limpar a superfície de montagem com um produto de limpeza adequado (sem produtos de limpeza domésticos gordurosos) e um pano sem pêlos e deixar secar completamente.
- Retirar a película protetora da fita adesiva
- Pressionar **firmente** o suporte de parede sobre a superfície de montagem.

5 Pipetagem

1. Inserir pipeta

⚠ AVISO



Verificar se a pipeta está bem assente. Nunca utilizar a força! Especialmente em pipetas finas existe o perigo de quebra do vidro! Perigo de ferimentos!

1.



- a. Segurar sempre a pipeta o mais próximo possível da extremidade superior e empurrá-la cuidadosamente para dentro do adaptador até estar firmemente sentada.
- b. Segurar sempre na vertical o dispositivo com a pipeta inserida, com a ponta para baixo.

2. Encher pipeta

2.

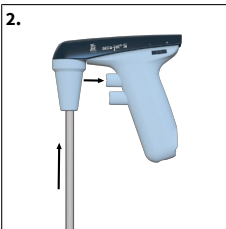

- a. Mergulhar a ponta da pipeta no líquido.
- b. Pressione lentamente o botão superior de pipetagem e preencha a pipeta de modo a que o menisco fique ligeiramente acima das marcas desejadas.
- c. Se ambos os botões de pipetagem forem pressionados, é possível aspirar ou distribuir líquido de forma muito sensível. Isto é especialmente

útil quando se ajusta o menisco ou se usam pipetas com pequenos volumes.

NOTA

Não encher demasiado a pipeta.

3. Ajustar volumes

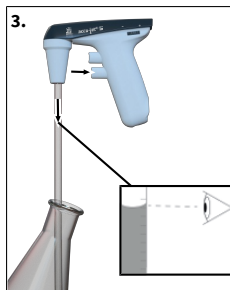

- a.** Limpar a ponta da pipeta com um pano adequado sem fiapos, se necessário.
- b.** Empurrar lentamente o botão de pipetagem inferior e drenar o líquido até que o menisco seja colocado exatamente na marca desejada.

4. Esvaziar a pipeta

- a.** Pressione lentamente no botão de pipetagem inferior. A velocidade de pipetagem depende de até que ponto os botões de pipetagem são pressionados. No modo de operação "Sopro com apoio do motor", também depende da rotação do motor ajustada.

5. Após a pipetagem

- a.** Segurar a pipeta o mais alto possível e retirá-la do adaptador.

6 Limpeza

NOTA

accu-jet® S não é autoclavável

Ocasionalmente limpar as peças da caixa com um pano húmido. Em caso de utilização correta, o aparelho é isento de manutenção.

6.1 Verificar a estanqueidade

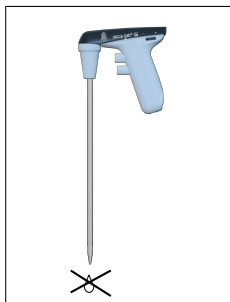

Após ajustar o menisco, nenhum líquido deve gotear da pipeta sem acionar as válvulas. Se a pipeta gotear, ver Avaria - O que fazer?

6.2 Substituir o filtro e limpar o adaptador

AVISO



Perigo de contaminação e de infeção

Usar luvas de proteção e proteção ocular.



NOTA

A substituição ou limpeza do filtro só é necessária se uma pipeta tiver sido preenchida em excesso ou se o desempenho de sucção for prejudicado.

b.

- a.** Retirar pipeta.
- b.** Desaparafusar a caixa do adaptador.
- c.** Retirar a caixa superior.

d.

- d.** Pressione o adaptador e o filtro de membrana a partir do lado cónico da caixa do adaptador.

e.

- e.** Retirar o filtro de membrana defeituoso.

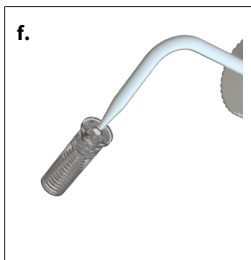

- f.** Para limpeza, enxaguar cuidadosamente o adaptador com um frasco pulverizador cheio com um líquido de limpeza adequado, por exemplo, água. De seguida, soprar e secar.

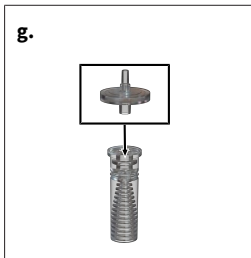

- g.** Pressione primeiro o novo filtro de membrana no adaptador com a ligação mais grossa virada para baixo (o lado mais fino e cónico virado para cima) e inserir na caixa do adaptador.

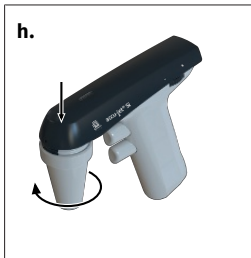

- h.** Pressionar a parte superior da carcaça para dentro das carcaças da caixa e aparafusar na carcaça do adaptador.

Nota sobre filtros auto claváveis

A eficácia da autoclavagem deve ser verificada pelo próprio utilizador. Nem todos os filtros de membrana são adequados! Utilizar apenas acessórios originais.

- > O dispositivo está equipado com um filtro de membrana de 0,2 µm (código de cor vermelho) como padrão.
 - > O filtro de membrana pode ser auto clavado até cinco vezes a 121 °C (250 °F).
 - > Com filtro de membrana de 0,2 µm (para cultura de células), podem ser alcançadas tolerâncias de volume de classe B.
 - > Para satisfazer as tolerâncias de volume de classe A, são necessários filtros de membrana de 3 µm. Estas têm menos influência no tempo de fluxo livre das pipetas devido ao maior tamanho dos poros, ver .
-

6.3 Desinfecção UV

O dispositivo é resistente à exposição habitual a uma lâmpada de desinfecção UV. Uma mudança de cor é possível como resultado da exposição UV.

7 Avaria - O que fazer?





Avaria	Causa	O que fazer?
Capacidade de sucção perturbada	A rotação do motor está reduzida	Aumentar a rotação do motor, ver Ajustar a rotação do motor, S. 188 .
	Válvula de retenção fechada	Definir interruptor seletor para soprar e pressionar o botão de pipetagem inferior, ver selecionar modo de funcionamento, S. 187
A pipeta goteia	Filtro não encaixado corretamente	Inserir corretamente o filtro, ver Substituir o filtro e limpar o adaptador, S. 192 .
	Adaptador ou a pipeta danificado	Substituir o adaptador ou a pipeta, ver Substituir o filtro e limpar o adaptador, S. 192 .
A pipeta não se mantém no adaptador	Adaptador sujo ou danificado	Limpar o adaptador, secar ao ar e substituir se necessário, ver Substituir o filtro e limpar o adaptador, S. 192 .
O indicador LED de carga não acende/pisca após a fonte de alimentação ter sido ligada e a fonte de energia ter sido estabelecida.	Ficha da bateria não fixo inserida	Inserir a ficha da bateria firmemente, ver Ligar a bateria, S. 184 .
	Fonte de alimentação errada	Utilize apenas a fonte de alimentação original, ver Elementos de funções e de comando, S. 182
	Bateria ou fonte de alimentação defeituosa	Substituir bateria/fonte de alimentação
	Dispositivo defeituoso	Devolver o dispositivo para reparação, ver Reparação, S. 198
Capacidade da bateria reduzida	Bateria defeituosa	Substituir a bateria, ver Ligar a bateria, S. 184 .
O dispositivo não mostra nenhuma função	Erro interno (realizar reinicialização)	Desligar a ficha da bateria e manter pressionado um botão de pipetagem durante 10 segundos. Depois voltar a ligar firmemente a ficha da bateria, ver Ligar a bateria, S. 184 e Pipetagem, S. 190

Se não conseguir resolver o problema utilizando a tabela de falhas acima, contate diretamente o seu revendedor especializado ou o fabricante.

8 Dados técnicos

Dados técnicos	Valores
Tomada de carregamento	5 VDC
Fonte de alimentação	Entrada: 100 – 240 VAC, 50/60 Hz Saída: 5 VDC
Bateria	Conjunto de baterias NiMH 2,4 V, 730 mAh Tempo de carregamento: 4 h Tempo máximo de trabalho: aprox. 8 h Temperatura de carregamento: +10 °C até +35 °C

8.1 Identificação no produto

Carateres ou números	Significado
XXZXXXXX	Número de série
Código de Resposta Rápida	Contém o número de série
	Com este símbolo, confirmamos que o produto preenche os requisitos especificados nas diretivas da CE e foi submetido aos procedimentos de teste especificados.
	UKCA: United Kingdom Conformity Assessed Com esta marca confirmamos que o produto cumpre os requisitos estabelecidos nas UK Designated Standards .
www.brand.de/ip	Informação sobre patentes
 (aqui: 40 anos)	China RoHS (EFUP) EFUP, o EFUP define o período em anos durante o qual as substâncias perigosas contidas em equipamentos elétricos e eletrónicos não vazam ou se alteram em condições normais de funcionamento. Sob utilização normal pelo utilizador, tais produtos elétricos e eletrónicos não causam poluição ambiental grave, lesões físicas graves ou danos à propriedade do utilizador.
	O dispositivo elétrico não deve ser eliminado juntamente com o lixo doméstico.

9 Reparação

9.1 Enviar para reparação

NOTA

O transporte de materiais perigosos sem licença é proibido por lei.

Limpar e descontaminar completamente o aparelho!

- Aquando da devolução de produtos, incluir sempre uma descrição precisa do tipo de avaria e dos meios utilizados. Em caso de meio utilizado não especificado, o aparelho não pode ser reparado.
- Envie só o dispositivo sem a bateria ou pilha.
- O transporte de retorno é realizado por conta e risco do remetente.

Fora dos EUA e do Canadá

Preencher a "Declaração relativa à segurança sanitária" e enviá-la juntamente com o aparelho ao fabricante ou distribuidor. Os formulários podem ser solicitados ao distribuidor ou fabricante ou podem ser descarregados em www.brand.de.

Dentro dos EUA e do Canadá

Esclareça com a BrandTech Scientific, Inc. os requisitos para a devolução **antes** de enviar o aparelho à assistência técnica.

Envie exclusivamente aparelhos limpos e descontaminados para o endereço que recebeu juntamente com o número de devolução. Colocar o número de devolução no exterior do pacote de modo bem visível.

Endereço de contacto

Alemanha:

BRAND GMBH + CO KG
Otto-Schott-Straße 25
97877 Wertheim (Alemanha)
T +49 9342 808 0
F +49 9342 808 98000
info@brand.de
www.brand.de

EUA e Canadá:

BrandTech® Scientific, Inc.
11 Bokum Road
Essex, CT 06426-1506 (EUA)
T +1-860-767 2562
F +1-860-767 2563
info@brandtech.com
www.brandtech.com

Índia:

BRAND Scientific Equipment Pvt. Ltd.
303, 3rd Floor, 'C' Wing, Delphi
Hiranandani Business Park,
Powai
Mumbai-400 076 (Índia)
T +91 22 42957790
F +91 22 42957791
info@brand.co.in
www.brand.co.in

China:

BRAND (Shanghai) Trading Co., Ltd.
Guangqi Culture Plaza
Room 506, Building B
No. 2899, Xietu Road
Shanghai 200030 (P.R. China)
T +86 21 6422 2318
F +86 21 6422 2268
info@brand.com.cn
www.brand.cn.com

10 Informações sobre a encomenda

10.1 Dispositivo

Cor da parte superior da caixa	N.º Enc. (com fonte de alimentação universal e adaptador de país)	N.º Enc. (sem fonte de alimentação universal e sem adaptador de país)
Antracite	26350	26360
Baga	26351	26361
Petróleo	26352	26362
Ametista	26353	26363

Escopo de entrega, ver . Observe os números de pedido, com ou sem fonte de alimentação.

10.2 Peças de reposição

Filtro de membrana de reserva

Descrição	Uni. emb.	N.º Enc.
0,2 µm, estéril (código de cor vermelho)	1 un. em embalagem de blister	26530
0,2 µm	10 un. em bolsa PE	26535
3 µm	1 un. em embalagem de blister	26052
3 µm	10 un. em bolsa PE	26056

Fonte de alimentação

Dados técnicos da fonte de alimentação, ver Dados técnicos, S. 197 .

Tipo	N.º Enc.
Fonte de alimentação com adaptador de país	26606

Conjunto de baterias

Dados técnicos da bateria, ver Dados técnicos, S. 197 .

Descrição	N.º Enc.
Conjunto de baterias NiMH	26630

Adaptador de silicone com válvula de retenção

Descrição	N.º Enc.
Adaptador de silicone	26508

Caixa do adaptador

Cor	N.º Enc.
branco	26658

Suporte de parede

Cor	N.º Enc.
branco	26539

Fita adesiva

Emb. Unid.	N.º Enc.
3 conjuntos	26547

11 Responsabilidade por defeitos

Não assumimos responsabilidade pelas consequências de manuseamento, utilização, manutenção, operação incorreta ou reparação não autorizada do dispositivo, nem pelas consequências do desgaste normal, especialmente de peças de desgaste como, por ex., êmbolos, vedantes, válvulas, assim como em caso de quebra de vidro. O mesmo se aplica à não-observância das instruções de utilização. Em particular, não assumimos qualquer responsabilidade por danos causados se o dispositivo tiver sido desmontado para além do descrito no manual de instruções ou se tiverem sido montadas peças de acessórios ou de substituição externas.

EUA e Canadá:

Podem ser consultadas informações relativamente à responsabilidade por defeitos em www.brandtech.com.

12 Eliminação



O símbolo adjacente significa que as pilhas/baterias e aparelhos eletrônicos no final da sua vida útil devem ser eliminados separadamente do lixo doméstico (resíduos urbanos não separados).

Conforme a diretiva 2012/19/UE do Parlamento Europeu e do Conselho de 04 de julho de 2012 relativa a aparelhos elétricos e eletrônicos usados, os aparelhos eletrônicos devem ser eliminados corretamente de acordo com as normas nacionais de eliminação.

As pilhas e baterias contêm materiais prejudiciais para o meio ambiente e para a saúde humana. Por isso, de acordo com a diretiva 2006/66/CE o Parlamento Europeu e do Conselho de 6 de setembro de 2006 relativa a pilhas e baterias, devem ser eliminadas de acordo com as normas nacionais de eliminação. Eliminar apenas pilhas e baterias completamente descarregadas.

EU-Konformitätserklärung | EU Declaration of Conformity

Produktbezeichnung: Product name:	Pipettierhelfer accu-jet® S / Pipetting controller accu-jet® S
Produktvarianten: Product variations:	Anthrazit, Beere, Petrol, Amethyst / anthracite, berry, petrol, amethyst
Art-Nr. / Cat.-No.	26350, 26351, 26352, 26353, 26360, 26361, 26362, 26363

Das oben beschriebene Produkt entspricht den grundlegenden Anforderungen, die in den nachfolgend bezeichneten Harmonisierungsrechtsvorschriften festgelegt sind: The product described above meets the basic requirements that are specified in the harmonization legislation listed below:	Angewendete harmonisierte Normen: Applied harmonized standards:
RoHS: 2011/65/EU incl.2015/863/EU EMC: 2014/30/EU	EN IEC 63000:2018 EN 61326-1:2013
Weitere angewendete Normen: Other applied standards:	Geltungsbereich: Scope:
EN 61010-1:2010, EN 61010-1:2010/A1:2019/AC:2019-04 EN/IEC 62368-1:2014 (angewendet auf Fremdherstellernetzteil / applied to third-party power supply)	NRL / LVD NRL / LVD

Die alleinige Verantwortung für die Ausstellung dieser Konformitätserklärung in Bezug auf die Erfüllung der grundlegenden Anforderungen und die Anfertigung der technischen Unterlagen trägt der Hersteller.

The manufacturer is solely responsible for issuing this declaration of conformity with regard to meeting the essential requirements and preparing the technical documentation.

Hersteller / Manufacturer	Adresse / Address
BRAND GMBH + CO KG	Otto-Schott-Str. 25 97877 Wertheim Germany

Wertheim, 01. Juli 2022 / 01 July 2022



Patrick Ziemeck
Managing Director Technology



i.A. Siegfried Ott
Regulatory Affairs

Diese Erklärung bescheinigt die Übereinstimmung mit den genannten Harmonisierungsvorschriften, beinhaltet jedoch keine Zusicherung von Eigenschaften.

This document declares the accordance with the named harmonized regulations, but does not assure specific properties.

UK Declaration of Conformity

Product name: Pipetting controller accu-jet® S
Product variations: anthracite, berry, petrol, amethyst
Cat.-No. 26350, 26351, 26352, 26353, 26360, 26361, 26362, 26363

The product described above meets the basic requirements that are specified in the harmonization legislation listed below:	Applied harmonized standards:
The Restriction of the Use of Certain Hazardous Substances in Electrical and Electronic Equipment Regulations 2012 (SI 2012 No. 3032)	EN IEC 63000:2018
Electromagnetic Compatibility Regulations 2016 (SI 2016 No. 1091, as amended by SI 2019 No. 696)	EN 61326-1:2013
Other applied standards:	Scope:
EN 61010-1:2010, EN 61010-1:2010/A1:2019/AC:2019-04 EN/IEC 62368-1:2014 (angewendet auf Fremdherstellernetzteil / applied to third-party power supply)	LVD LVD

The manufacturer is solely responsible for issuing this declaration of conformity with regard to meeting the essential requirements and preparing the technical documentation.

Manufacturer	Address
BRAND GMBH + CO KG	Otto-Schott-Str. 25 97877 Wertheim Germany

Wertheim, 18 February 2022



Patrick Ziemeck
Managing Director Technology



i.A. Siegfried Ott
Regulatory Affairs

This document declares the accordance with the named harmonized regulations, but does not assure specific properties.

Declaration of conformity – China RoHS 2

BRAND GMBH + CO KG has made reasonable efforts to ensure that hazardous materials and substances may not be used in BRAND products.

In order to determine the concentration of hazardous substances in all homogeneous materials of the subassemblies, a “Product Conformity Assessment” (PCA) procedure was performed. As defined in GB/T 26572 the “Maximum Concentration Value” limits (MCV) apply to these restricted substances:

+ Lead (Pb):	0.1%	+ Hexavalent chromium (Cr(+VI)):	0.1%
+ Mercury (Hg):	0.1%	+ Polybrominated biphenyls (PBB):	0.1%
+ Cadmium (Cd):	0.01%	+ Polybrominated diphenyl ether (PBDE):	0.1%

Environmental Friendly Use Period (EFUP)

EFUP defines the period in years during which the hazardous substances contained in electrical and electronic products will not leak or mutate under normal operating conditions. During normal use by the user such electrical and electronic products will not result in serious environmental pollution, cause serious bodily injury or damage to the user's assets.

The Environmental Friendly Use Period for BRAND instruments is 40 years.



Material Content Declaration for BRAND Products

部件名称 Part name	有毒有害物质或元素 Hazardous substances					
	铅 Pb	汞 Hg	镉 Cd	六价铬 Cr(+VI)	多溴联苯 PBB	多溴二苯醚 PBDE
包装 / Packaging	0	0	0	0	0	0
塑料外壳 / 组件 Plastic housing / parts	0	0	0	0	0	0
电池 / Battery	0	0	0	0	0	0
玻璃 / Glass	0	0	0	0	0	0
电子电气组件 Electrical and electronic parts	X	0	0	0	0	0
金属外壳 / 组件 Metal housing / parts	X	0	0	0	0	0
电机 / Motor	X	0	0	0	0	0
配件 / Accessories	X	0	0	0	0	0

此表格是按照SJ/T 11364-2014中规定所制定的。

This table is created according to SJ/T 11364-2014.

- O: 表示该有毒有害物质在该部件所有均质材料中的含量均在GB/T 26572规定的限量要求以下。
O: Indicates that the above mentioned hazardous substance contained in all homogeneous materials of the part is below the required limit as defined in GB/T 26572.
- X: 表示该有毒有害物质至少在该部件某一均质材料中的含量超出GB/T 26572规定的限量要求。
X: Indicates that the above mentioned hazardous substance contained in at least one of the homogeneous materials of this part is above the required limit as defined in GB/T 26572.

注释： 电池，玻璃制品和配件可能不属于此设备的一部分且/或可能有它自己的EFUP标志且/或可能包含更改EFUP标志的部件。

Note: Batteries, glassware and accessories might not be content of the enclosed device and/or may have their own EFUP-marking and/or might be maintaining parts with changing EFUP-marking.

除上表所示信息外，还需声明的是，这些部件并非是有用铅 (Pb), 汞 (Hg), 镉 (Cd), 六价铬 (Cr(+VI)), 多溴联苯 (PBB) 或多溴二苯醚 (PBDE) 来制造的。

Apart from the disclosures in the above table, the subassemblies are not intentionally manufactured or formulated with lead (Pb), mercury (Hg), cadmium (Cd), hexavalent chromium (Cr+VI), polybrominated biphenyls (PBB), and polybrominated diphenyl ethers (PBDE).

Products manufactured by BRAND may enter into further devices or can be used together with other appliances. With these third party products and appliances in particular, please note the EFUP labeled on these products. BRAND will not take responsibility for the EFUP of those products and appliances.

Place, date: Wertheim, 05|04|2022



Patrick Ziemeck
(Managing Director Technology)



i.A. Siegfried Ott
(Regulatory Affairs)

目录

1 引言	210
1.1 供货范围	210
1.2 使用规定	210
2 安全	212
2.1 功能	213
2.2 使用限制条件	213
2.3 使用排除范围	213
2.4 储存条件	213
3 功能和操作元件	215
4 调试	216
4.1 连接电池	216
4.2 电池充电	218
4.3 启动设备	219
4.4 选择运行模式	219
4.5 吸液或放液	219
4.6 更改移液速度	219
4.7 调节电机转速	219
4.8 保管设备	220
5 吸移	221
6 清洁	223
6.1 检查密封性	223
6.2 更换过滤器和清洁适配器	223
6.3 紫外线消毒	226
7 故障——如何处理？	227
8 技术参数	228
8.1 产品上的标识	228
9 维修	229
9.1 送修	229
10 订购信息	231
10.1 设备	231

10.2 备件	231
11 缺陷责任	233
12 废弃处理	234

1 引言

1.1 供货范围

移液器控制器，镍氢电池，可选的电源装置（注意不同的订货号），2个备用的0.2微米的膜过滤器，壁式支架，使用说明

1.2 使用规定

- 在第一次使用前请认真阅读本使用说明书。
- 该使用说明书是此设备所包含的部分，必须妥善保存并且易于取阅。
- 如果将本设备交予第三方，须随附本使用说明书。

1.2.1 危险等级

下列信号词提示可能存在的危险：

信号词	含义
危险	将导致重伤或死亡。
警告	可能导致重伤或死亡。
小心	可能导致轻伤或中度伤害。
提示	可能导致损失财物。

1.2.2 使用说明书的符号

图标	含义	图标	含义
	危险位置		爆炸危险
	戴护目镜		戴防护手套

1.2.3 图示

图示	含义	图示	含义
1.Task	表示一项任务。	>	表示一项前提条件。
a., b., c.	表示任务的单个步骤。	⇒	表示结果。

2 安全

务必请仔细阅读！

实验室设备 accu-jet® S 可与危险材料、工作过程和配件结合使用。本使用说明书未展示可能出现的安全问题。用户有责任确保遵守安全法规和健康法规，并在使用前确定存在的限制条件。

1. 所有使用者在使用本设备之前必须阅读和注意本使用说明书。
2. 遵守一般危险提示和安全法规，例如穿戴防护服、护目镜和防护手套。
3. 请注意试剂供应商提供的说明。
4. 请勿在潜在爆炸性气体环境中使用设备，请勿对易燃介质进行移液。
5. 仅将设备用于液体计量，并且仅在规定的使用限制内使用。注意使用排除范围，参见使用排除范围，页 213！如有疑问，请联系制造商或者经销商。
6. 请始终以对使用者及他人均安全的方式使用该设备。避免飞溅。仅使用合适的容器。
7. 切勿使用暴力。
8. 仅使用原装配件和备件。不得进行任何技术更改。不得违背使用说明书的说明进一步拆解设备！
9. 使用前请检查本设备的状态是否正常。如果有设备故障迹象，请立即停止移液并遵照章节 Störung - Was tun? 进行操作。必要时请联系制造商。
10. 只允许使用原装电源为镍氢电池充电。
11. 电池不得更换为其他制造商的电池。
12. 电源必须防潮，并且只允许和本设备搭配使用。
13. 如果连接电缆损坏，请不要使用电源。
14. 只允许由获授权的服务技术人员对设备进行修理和干预。

2.1 功能

该设备用作容量范围在 0.1 ml 至 200 ml 之间且吸管外径小于 9.2 mm 的玻璃或塑料测量和容量移液器吸移液体的辅助工具。在正确处理时，待计量的液体仅与移液器接触。

2.2 使用限制条件

设备用于在注意以下物理极限条件的情况下吸移液体：

- +10 ° C 至 +40 ° C (从 50 ° F 至 104 ° F) 之间 (设备和试剂)
- 蒸汽压力最高 500 mbar。超过 300 mbar 时缓慢吸取，以避免液体沸腾。
- 密度最大 9 g/cm³

2.3 使用排除范围

该设备不得用于其蒸汽有腐蚀性或会侵蚀硅胶或者 EPDM 材质的液体。

该设备不适用于巴斯德吸管。

警告



爆炸性环境中使用设备

设备不得在潜在爆炸性环境中使用或充电。不得对高度易燃的介质 (闪点低于 0° C (32° F)，如乙醚、丙酮) 进行移液。

2.4 储存条件

该设备和配件必须在清洁后进行冷却、干燥式存放。

存放温度：-20 ° C 至 +50 ° C (-4 ° F 至 122 ° F)。

2 安全

相对空气湿度：5 % 至 95 %。

3 功能和操作元件

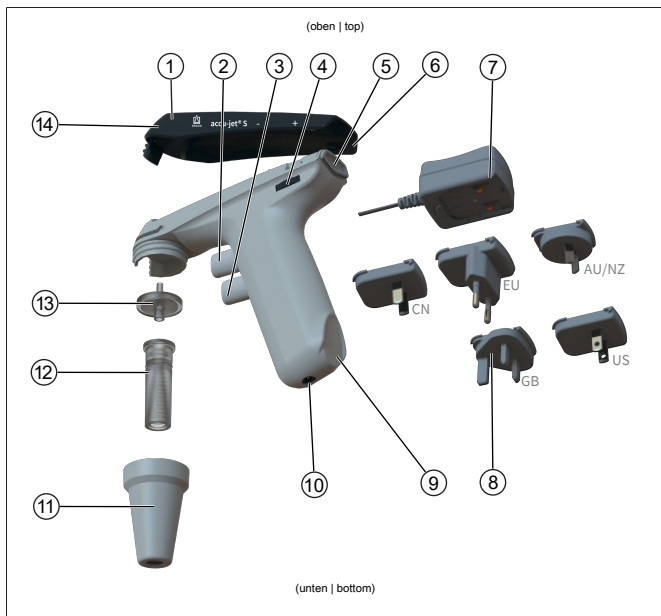

- | | |
|----------------|---------------------|
| 1 外壳上壳 | 2 上移液按钮（吸取液体） |
| 3 下移液按钮（放掉液体） | 4 电机转速调节轮 |
| 5 运行模式选择开关 | 6 外壳上壳的支承面 |
| 7 电源 | 8 充电适配器 |
| 9 把手支承面 | 10 充电插口 |
| 11 适配器外壳（PP） | 12 适配器/止回阀（SI/PTFE） |
| 13 滤膜（PP/PTFE） | 14 压力平衡孔 |

有关电压和耗电量的信息，参见 技术参数，页 228。

缩写	材料
PP	聚丙烯
PTFE	聚四氟乙烯
SI	硅胶

4 调试

4.1 连接电池

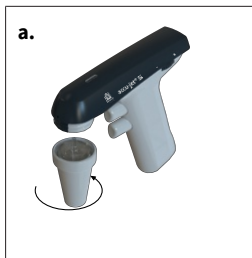

- a. 拧下适配器外壳。适配器和过滤器留在适配器外壳中。

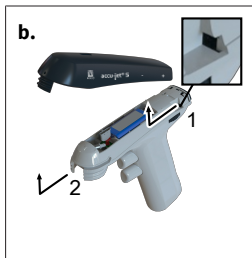

- b. 拆下外壳。沿适配器外壳的螺纹接头方向略微推动外壳。
- ⇒ 外壳自行从调节轮 (1) 上方的凹槽和适配器外壳 (2) 的螺纹接头中脱离。
- ⇒ 可以看见电池盒。

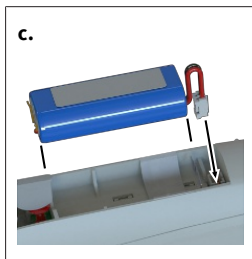

- c. 将电池插头固定在电缆上，对齐并牢固地插入插口中，直到可听到卡入声。放入电池。

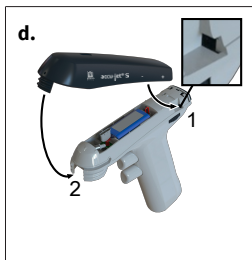

- d. 放入外壳。这时候要注意，外壳嵌合到调节轮 (1) 上方指定凹槽中，并且嵌合到适配器外壳 (2) 的螺纹接头中。

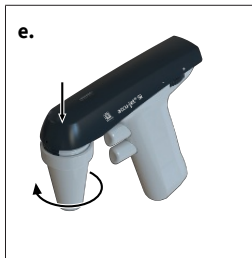

- e. 将外壳上部压入外壳壳体中，并拧上适配器外壳。

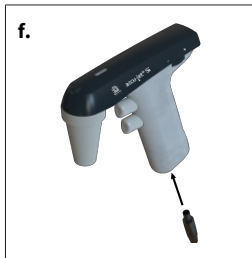

- f. 为电池充电，直到 LED 充电指示灯闪烁绿色。充电时间约 4 小时，请参见 电池充电。

4.2 电池充电

警告



损坏的电源或充电电缆

因触电导致的受伤危险。

- > 不得使用损坏的电源。
- > 如果充电电缆损坏，请勿使用电源。



注意

仅使用制造商的原装电源！

使用不同的电源可能会损坏设备和电池。

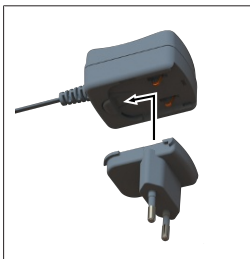

- a. 将国家专用适配器插入电源。
 - b. 将电源连接到设备上。
 - c. 将电源插入电源插头中。
- ⇨ 设备正在充电。可通过外壳上部的 LED 充电指示灯来识别。有关运行时长和充电时间，请参见 Technische Daten, 页 228。

LED 充电指示灯	状态	如何处理？
绿： 闪烁	电池正在充电。正在进行涓流充电。	您可以使用该设备进行工作。设备已充满电。
绿： 长亮	电池充电中	也可以一边充电一边继续工作。
红： 闪烁	电池电量几乎为空。	中断使用该设备的工作。给电池充电。也可以一边充电一边继续工作。
红： 长亮	电池电量为空。	给电池充电。

注意

- > 涓流充电可防止过载，并最大限度地减少电池休眠效应。为了获得最大容量，请在 LED 充电指示灯亮之前不要对电池进行充电。

4.3 启动设备

放入充过电的电池后，设备即运行准备就绪。没有 ON/OFF 开关。

4.4 选择运行模式

选择开关，请参见 功能和操作元件，页 215。

“自由流出”运行模式：向上扳选择开关。

“电机辅助吹出”运行模式：向下扳选择开关。

4.5 吸液或放液

移液按钮，请参见 功能和操作元件，页 215

按下上移液按钮移液器充液，按下下移液按钮移液器放液。

4.6 更改移液速度

速度受所设最大电机转速限制。上移液按钮或下移液按钮压入越深，则吸液或排液的速度就越快。

4.7 调节电机转速

调节轮，请参见 功能和操作元件，页 215

通过转动调节轮，可以在最大 (+) 到最小 (-) 范围内连续调节电机转速。我们建议大容量移液器采用最大电机转速，小容量移液器采用较小电机转速。

4.8 保管设备

4.8.1 台式搁架

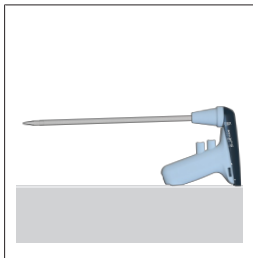

accu-jet® S 可以在插有移液器的状态下放在平坦表面上。

4.8.2 墙壁支架



- a. 使用适当的清洁剂（不得使用渗油的家用洗涤剂）和无绒布清洁安装表面并等待其干燥。
- b. 从胶带上撕下保护膜
- c. 将墙壁支架**牢固**地压在安装表面上。

5 吸移

1. 插上移液器

警告



注意移液器位置是否固定。切勿使用暴力！尤其是薄壁移液器，存在玻璃断裂危险！受伤危险！

1.



- 始终尽可能密封地抓住移液器的上部末端，并小心地推入到适配器中，直到停止不动。
- 始终保持插有移液器的设备垂直，吸头朝下。

2. 填充移液器

2.

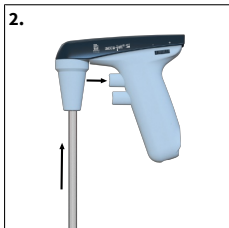

- 将移液器吸头浸入液体中。
- 慢慢按下移液器顶部按钮并填充移液器，使弯月面略高于所需的标记。
- 如果按下两个移液按钮，则它们可以非常灵敏地吸液或放液。这在调整半月板或使用小容量移液器时特别有用。

注意

不要过度填充移液器。

3. 调节体积

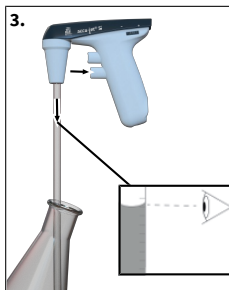

- a. 必要时用无纤维的毛巾擦拭移液器吸头。
- b. 缓慢压入下移液按钮并放液，直到弯月面正好被调节到所需标记位置。

4. 排空移液器

- a. 慢慢压入下移液按钮。移液速度取决于移液按钮被压入多深。“电机辅助吹出”运行模式下，它还取决于电机转速。

5. 吸移后

- a. 尽可能抓住移液器上部位置，然后将其从适配器中拉出。

6 清洁

注意

accu-jet® S不可高压灭菌

时不时用沾湿的毛巾擦拭外壳部件。常规使用时设备无需维护。

6.1 检查密封性

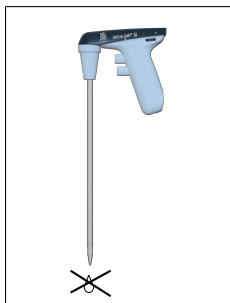

调整弯月面之后，如果不致动阀，则不得有液体从移液器中滴落。如果移液器滴液，请参见 故障 - 如何处理？

6.2 更换过滤器和清洁适配器

警告



污染和感染的风险
戴防护手套和护目镜。



注意

只有在移液器过度填充或者抽吸功能受不利影响时才必要更换过滤器或进行清洁。

b.



- a. 抽出移液器。
- b. 拧下适配器外壳。
- c. 移除顶部外壳。

d.



- d. 从适配器外壳的锥形侧推出适配器和滤膜。

e.

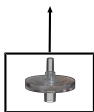

- e. 抽出有缺陷的滤膜。



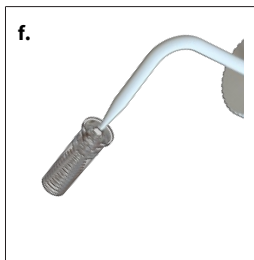

- f.** 清洁适配器时，使用例如水等适当的清洁液体小心地冲洗吸头瓶。之后吹干并晾干。

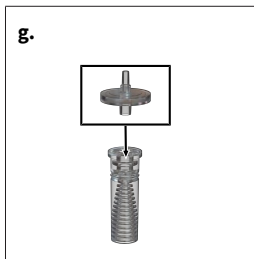

- g.** 首先将具有更厚接口的新滤膜向下压入适配器中（更薄的锥形侧朝上）并装入适配器外壳中。

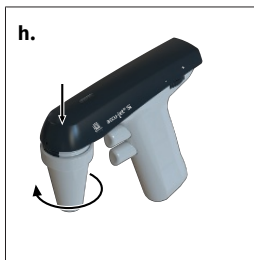

- h.** 将外壳上部压入外壳壳体中，并拧上适配器外壳。

注意

关于高压灭菌过滤器的提示

用户每次应自行对高压消毒处理的有效性进行仔细检查。并非每一个滤膜都适合！仅使用原装配件。

- > 该装置标配 0.2 μ m 滤膜（红色颜色代码）。
 - > 滤膜在 121 ° C (250 ° F) 条件下最多可以高温消毒五次。
 - > 使用 0.2 μ m 滤膜（用于细胞培养），可实现 B 类体积公差。
 - > 为了符合 A 类体积公差，需要使用 3 μ m 滤膜。由于孔径较大，这些对移液器的自由流出时间的影响较小，请参见 。
-

6.3 紫外线消毒

该仪器耐受紫外线杀菌灯的常用功率。照射紫外线后颜色可能会变化。

7 故障——如何处理？

故障	原因	如何处理？
抽吸功率受到影响	电机转速降低	提高电机转速，请参见 调节电机转速，页 219。
	止回阀已关闭	将选择开关切换为吹出，并将下移液按钮按下，请参见 Betriebsart wählen，页 219
移液器滴液	过滤器位置不正确	正确放入过滤器，参见 Filter austauschen und Adapter reinigen，页 223。
	适配器或移液器损坏	正确放入适配器或移液器，参见 Filter austauschen und Adapter reinigen，页 223。
移液器未固定在适配器中	适配器脏污或损坏	清洁适配器，风干，必要时更换，请参见 Filter austauschen und Adapter reinigen，页 223。
LED 充电指示灯在连接电源和通电后不亮起/闪烁。	电池插头未牢固插入	牢固地插入电池插头，请参见 Akku anschließen，页 216。
	不正确的电源	仅使用原装电源，请参见 功能和操作元件，页 215
	电池或电源有缺陷	更换电池/电源
	设备有缺陷	将设备送修，请参见 维修，页 229
电池容量低	电池有缺陷	更换电池，请参见 Akku anschließen，页 216。
设备无功能显示	内部错误 (执行重置)	松开电池插头和移液按钮，并将其按住不放 10 秒。然后，再次插入电池插头，请参见 Akku anschließen，页 216 和 吸移，页 221

如果您无法通过上面的故障表解决问题，联系您的专业经销商或直接联系制造商。

8 技术参数

技术参数	数值
充电插口	5 VDC
电源	输入：100-240 VAC，50/60 Hz 输出：5 VDC
蓄电池	镍氢电池组 NiMH 2.4 V，730 mAh 充电时间：4 h 最长工作时间：约 8 小时 充电温度：+10 °C 至 +35 °C

8.1 产品上的标识

标志或编号	含义
XXZXXXXX	序列号
快速响应代码	包含序列号
	我方通过此标志确认产品符合 EC 指令的要求，并且已采用指定的检查方法。
	UKCA：英国合规性评估 我方通过此标志确认产品符合 UK Designated Standards 中指定的要求。
www.brand.de/ip	版权信息
 (此处：40 年)	中国 RoHS (EFUP) EFUP 确定了电气或电子设备中所含有的危险材料在正常运行条件下不会泄露或者改变。在用户正常使用时，此类电气和电子产品不会导致严重的环境污染、不会对用户造成严重的人身伤害或者财物损失。
	不得将电气设备与生活垃圾一起清理。

9 维修

9.1 送修

注意

法律明确禁止在未经许可的情况下运输有害材料。

彻底清洁仪器并清除污染物！

- 寄回产品时，原则上须附上故障类型与所使用介质的准确描述。如果缺失所使用介质的相关信息，仪器将不能得到维修。
- 仅发送不含蓄电池的仪器。
- 寄回仪器的风险和费用由寄件人承担。

在美国和加拿大之外

将“无健康危害声明”填写完整，并和仪器一同发送给您的经销商或制造商。可以向经销商或制造商索要表格，也可以从 www.brand.de 主页下载。

在美国和加拿大以内

在返修仪器**之前**，请联系 BrandTech Scientific, Inc. 确认寄回仪器需满足的各项前提。

只接受已清洁并已去除污染物的仪器，将和返修授权码一同告知您地址。将返修授权码标在包装外侧的显眼位置。

联系地址

德国：

BRAND GMBH + CO KG
Otto-Schott-Straße 25
97877 Wertheim (Germany)

美国和加拿大：

BrandTech® Scientific, Inc.
11 Bokum Road
Essex, CT 06426-1506 (USA)

9 维修

电话 +49 9342 808 0
传真 +49 9342 808 98000
info@brand.de
www.brand.de

电话 +1-860-767 2562
传真 +1-860-767 2563
info@brandtech.com
www.brandtech.com

印度：

BRAND Scientific Equipment Pvt.Ltd.
303, 3rd Floor, 'C' Wing, Delphi
Hiranandani Business Park,
Powai
Mumbai - 400 076 (India)
电话 +91 22 42957790
传真 +91 22 42957791
info@brand.co.in
www.brand.co.in

中国：

普兰德（上海）贸易有限公司
广汽文化广场 B 栋
506 室，
斜土路2899 号光启
上海 200030（中华人民共和国），邮编
200030
电话 +86 21 6422 2318
传真 +86 21 6422 2268
info@brand.com.cn
www.brand.cn.com

10 订购信息

10.1 设备

外壳上部的颜色	订购号 (带通用电源和国家适配器)	订购号 (不带通用电源和国家适配器)
无烟煤	26350	26360
浆果色	26351	26361
石油蓝	26352	26362
紫水晶色	26353	26363

供货范围，请参见 。请注意订单号，带或不带电源。

10.2 备件

备用滤膜

产品描述	包装单位	订购号
0.2 μ m, 无菌 (红色颜色代码)	每份吸塑包装 1 件	26530
0, 2 μ m	PE 包装袋中 10 件	26535
3 μ m	每份吸塑包装 1 件	26052
3 μ m	PE 包装袋中 10 件	26056

电源

针对电源的技术数据，请参见技术参数，页 228。

型号	订购号
有充电适配器的电源	26606

电池组

针对电池的技术数据，请参见技术参数，页 228。

产品描述	订购号
镍氢电池组	26630

带止回阀的硅胶适配器

产品描述	订购号
硅胶适配器	26508

适配器外壳

颜色	订购号
白	26658

墙壁支架

颜色	订购号
白	26539

胶带

包装单位	订购号
3 套	26547

11 缺陷责任

我们不承担由于不当拿取，使用，服务，操作或未授权的仪器维修产生的结果，我们同样不承担由于正常易损件如活塞，密封垫圈，阀门的磨损或者玻璃破损而产生的结果。我们也不承担由于不按照操作手册/使用说明指导的操作而产生的结果。我们不承担由于进行任何操作手册未描述的拆卸 或由于非原装配件的使用而产生的结果。

美国和加拿大：

有关保修责任的信息 请参见 www.brandtech.com。

12 废弃处理



相邻图标表示，必须在电池 / 蓄电池和电子设备使用寿命结束时将其与生活垃圾（未分类的城市垃圾）分开清理。

根据欧洲议会和理事会 2012. 7. 04 关于废弃电气和电子设备的 2012/19/EC 指令，必须按照国家废物处理法规专业处理废弃电子设备。

蓄电池含有可能对环境 and 人类健康造成危害的物质。根据欧洲议会和理事会 2006. 9. 6 关于电池和蓄电池的 2006/66/EC 指令，必须根据国家废弃处理法专业处理废弃电池和蓄电池。废弃处理时必须将电池和蓄电池完全放电。

EU-Konformitätserklärung | EU Declaration of Conformity

Produktbezeichnung: Product name:	Pipettierhelfer accu-jet® S / Pipetting controller accu-jet® S
Produktvarianten: Product variations:	Anthrazit, Beere, Petrol, Amethyst / anthracite, berry, petrol, amethyst
Art.-Nr. / Cat.-No.	26350, 26351, 26352, 26353, 26360, 26361, 26362, 26363

Das oben beschriebene Produkt entspricht den grundlegenden Anforderungen, die in den nachfolgend bezeichneten Harmonisierungsrechtsvorschriften festgelegt sind: The product described above meets the basic requirements that are specified in the harmonization legislation listed below:	Angewendete harmonisierte Normen: Applied harmonized standards:
RoHS: 2011/65/EU incl.2015/863/EU EMC: 2014/30/EU	EN IEC 63000:2018 EN 61326-1:2013
Weitere angewendete Normen: Other applied standards:	Geltungsbereich: Scope:
EN 61010-1:2010, EN 61010-1:2010/A1:2019/AC:2019-04 EN/IEC 62368-1:2014 (angewendet auf Fremdherstellernetzteil / applied to third-party power supply)	NRL / LVD NRL / LVD

Die alleinige Verantwortung für die Ausstellung dieser Konformitätserklärung in Bezug auf die Erfüllung der grundlegenden Anforderungen und die Anfertigung der technischen Unterlagen trägt der Hersteller.

The manufacturer is solely responsible for issuing this declaration of conformity with regard to meeting the essential requirements and preparing the technical documentation.

Hersteller / Manufacturer	Adresse / Address
BRAND GMBH + CO KG	Otto-Schott-Str. 25 97877 Wertheim Germany

Wertheim, 01. Juli 2022 / 01 July 2022



Patrick Ziemeck
Managing Director Technology



i.A. Siegfried Ott
Regulatory Affairs

Diese Erklärung bescheinigt die Übereinstimmung mit den genannten Harmonisierungsvorschriften, beinhaltet jedoch keine Zusicherung von Eigenschaften.

This document declares the accordance with the named harmonized regulations, but does not assure specific properties.

UK Declaration of Conformity

Product name: Pipetting controller accu-jet® S
Product variations: anthracite, berry, petrol, amethyst
Cat.-No. 26350, 26351, 26352, 26353, 26360, 26361, 26362, 26363

The product described above meets the basic requirements that are specified in the harmonization legislation listed below:	Applied harmonized standards:
The Restriction of the Use of Certain Hazardous Substances in Electrical and Electronic Equipment Regulations 2012 (SI 2012 No. 3032)	EN IEC 63000:2018
Electromagnetic Compatibility Regulations 2016 (SI 2016 No. 1091, as amended by SI 2019 No. 696)	EN 61326-1:2013
Other applied standards:	Scope:
EN 61010-1:2010, EN 61010-1:2010/A1:2019/AC:2019-04 EN/IEC 62368-1:2014 (angewendet auf Fremdherstellernetzteil / applied to third-party power supply)	LVD LVD

The manufacturer is solely responsible for issuing this declaration of conformity with regard to meeting the essential requirements and preparing the technical documentation.

Manufacturer	Address
BRAND GMBH + CO KG	Otto-Schott-Str. 25 97877 Wertheim Germany

Wertheim, 18 February 2022



Patrick Ziemeck
Managing Director Technology



i.A. Siegfried Ott
Regulatory Affairs

This document declares the accordance with the named harmonized regulations, but does not assure specific properties.

Declaration of conformity – China RoHS 2

BRAND GMBH + CO KG has made reasonable efforts to ensure that hazardous materials and substances may not be used in BRAND products.

In order to determine the concentration of hazardous substances in all homogeneous materials of the subassemblies, a “Product Conformity Assessment” (PCA) procedure was performed. As defined in GB/T 26572 the “Maximum Concentration Value” limits (MCV) apply to these restricted substances:

+ Lead (Pb):	0.1%	+ Hexavalent chromium (Cr(+VI)):	0.1%
+ Mercury (Hg):	0.1%	+ Polybrominated biphenyls (PBB):	0.1%
+ Cadmium (Cd):	0.01%	+ Polybrominated diphenyl ether (PBDE):	0.1%

Environmental Friendly Use Period (EFUP)

EFUP defines the period in years during which the hazardous substances contained in electrical and electronic products will not leak or mutate under normal operating conditions. During normal use by the user such electrical and electronic products will not result in serious environmental pollution, cause serious bodily injury or damage to the user's assets.

The Environmental Friendly Use Period for BRAND instruments is 40 years.



Material Content Declaration for BRAND Products

部件名称 Part name	有毒有害物质或元素 Hazardous substances					
	铅 Pb	汞 Hg	镉 Cd	六价铬 Cr(+VI)	多溴联苯 PBB	多溴二苯醚 PBDE
包装 / Packaging	0	0	0	0	0	0
塑料外壳 / 组件 Plastic housing / parts	0	0	0	0	0	0
电池 / Battery	0	0	0	0	0	0
玻璃 / Glass	0	0	0	0	0	0
电子电气组件 Electrical and electronic parts	X	0	0	0	0	0
金属外壳 / 组件 Metal housing / parts	X	0	0	0	0	0
电机 / Motor	X	0	0	0	0	0
配件 / Accessories	X	0	0	0	0	0

此表格是按照SJ/T 11364-2014中规定所制定的。

This table is created according to SJ/T 11364-2014.

- O: 表示该有毒有害物质在该部件所有均质材料中的含量均在GB/T 26572规定的限量要求以下。
- O: Indicates that the above mentioned hazardous substance contained in all homogeneous materials of the part is below the required limit as defined in GB/T 26572.
- X: 表示该有毒有害物质至少在该部件某一均质材料中的含量超出GB/T 26572规定的限量要求。
- X: Indicates that the above mentioned hazardous substance contained in at least one of the homogeneous materials of this part is above the required limit as defined in GB/T 26572.

注释： 电池，玻璃制品和配件可能不属于此设备的一部分且/或可能有它自己的EFUP标志且/或可能包含更改EFUP标志的部件。

Note: Batteries, glassware and accessories might not be content of the enclosed device and/or may have their own EFUP-marking and/or might be maintaining parts with changing EFUP-marking.

除上表所示信息外，还需声明的是，这些部件并非是有用铅 (Pb), 汞 (Hg), 镉 (Cd), 六价铬 (Cr(+VI)), 多溴联苯 (PBB) 或多溴二苯醚 (PBDE) 来制造的。

Apart from the disclosures in the above table, the subassemblies are not intentionally manufactured or formulated with lead (Pb), mercury (Hg), cadmium (Cd), hexavalent chromium (Cr+VI), polybrominated biphenyls (PBB), and polybrominated diphenyl ethers (PBDE).

Products manufactured by BRAND may enter into further devices or can be used together with other appliances. With these third party products and appliances in particular, please note the EFUP labeled on these products. BRAND will not take responsibility for the EFUP of those products and appliances.

Place, date: Wertheim, 05|04|2022



Patrick Ziemeck
(Managing Director Technology)



i.A. Siegfried Ott
(Regulatory Affairs)

Содержание

1	Введение	241
1.1	Комплект поставки	241
1.2	Правила пользования	241
2	Правила техники безопасности.....	243
2.1	Функциональное предназначение.....	244
2.2	Ограничения по применению.....	244
2.3	Запреты на использование	245
2.4	Условия хранения	245
3	Функциональные элементы и органы управления	246
4	Ввод в эксплуатацию	248
4.1	Подключение аккумулятора	248
4.2	Зарядка аккумулятора	250
4.3	Запуск устройства.....	251
4.4	Выбор режима работы	251
4.5	Всасывание или дозирование жидкости	252
4.6	Изменение скорости дозирования	252
4.7	Установка частоты вращения двигателя	252
4.8	Хранение аппарата	253
5	Пипетирование	254
6	Очистка	256
6.1	Проверка плотности.....	256
6.2	Замена фильтра и очистка адаптера.....	257
6.3	УФ-стерилизация	259
7	Неисправность - что делать?.....	260
8	Технические данные	262
8.1	Маркировка на изделии	262

9 Ремонт	264
9.1 Отправка для ремонта.....	264
10 Информация для заказа	266
10.1 Аппарат	266
10.2 Запасные части	266
11 Ответственность за дефекты	268
12 Утилизация	269

1 Введение

1.1 Комплект поставки

Автоматический дозатор для пипеток, никель-металлгидридная аккумуляторная батарея, опционально - блок питания (обратите внимание на разные номера для заказа), 2 запасных мембранных фильтра 0,2 мкм, настенное крепление, инструкция по эксплуатации.

1.2 Правила пользования

- Перед первым использованием внимательно прочтите инструкцию по эксплуатации.
- Инструкция по эксплуатации является частью аппарата и должно храниться в легкодоступном месте.
- При передаче данного аппарата третьим лицам прилагайте к нему инструкцию по эксплуатации.

1.2.1 Степени опасности

Следующие сигнальные слова указывают на возможные опасности:

Сигнальное слово	Значение
ОПАСНОСТЬ	Приводит к серьезной травме или смерти.
ПРЕДУПРЕЖДЕНИЕ	Может привести к серьезной травме или смерти.
ОСТОРОЖНО	Может привести к травмам легкой или средней степени тяжести.
ПРИМЕЧАНИЕ	Может привести к материальному ущербу.

1.2.2 Символы руководства по эксплуатации

Символ	Значение	Символ	Значение
	Представляет опасность		Опасность взрыва
	Носить защитные очки		Носить защитные перчатки

1.2.3 Отображение

Отображение	Значение	Отображение	Значение
1. Task	Обозначает задание.	>	Обозначает предварительное условие.
a., b., c.	Обозначает отдельные этапы выполнения задания.	⇒	Обозначает результат.

2 Правила техники безопасности

Внимательно ознакомьтесь!

Лабораторный аппарат assu-jet® S может использоваться в сочетании с опасными материалами, рабочими процессами и оборудованием. Однако в инструкции по эксплуатации невозможно указать все проблемы с безопасностью, которые могут возникнуть. Пользователь несет ответственность за соблюдение правил техники безопасности и охраны труда, а также за установление соответствующих ограничений перед использованием.

1. Каждый пользователь должен прочитать и соблюдать данную инструкцию по эксплуатации перед использованием аппарата.
2. Соблюдайте общие предупреждения об опасности и инструкции по технике безопасности, например, носите защитную одежду, защитные очки и защитные перчатки.
3. Соблюдайте инструкции производителей реагентов.
4. Не эксплуатируйте аппарат во взрывоопасной атмосфере и не дозируйте им легковоспламеняющиеся среды.
5. Используйте прибор только для дозирования жидкостей и только в установленных пределах применения. Соблюдайте запреты на использование, см. Запреты на использование, Страница 245 ! При возникновении сомнений всегда обращайтесь к производителю или продавцу.
6. Всегда работайте так, чтобы не подвергать опасности ни пользователя, ни других людей. Избегайте образования брызг. Используйте только подходящие сосуды.
7. Никогда не применяйте силу.
8. Используйте только оригинальные принадлежности и оригинальные запасные части. Технические изменения не допускаются. Запрещается разбирать аппарат более детально, чем описано в инструкции по эксплуатации!

9. Перед использованием всегда проверяйте надлежащее состояние аппарата. При обнаружении каких-либо неисправностей в работе аппарата немедленно прекратите дозирование и следуйте указаниям главы Störung - Was tun? . При необходимости обратитесь к производителю.
10. Для зарядки никель-металлгидридного аккумулятора разрешается использовать только оригинальный блок питания.
11. Замена данного аккумулятора аккумуляторами других производителей не допускается.
12. Блок питания следует защищать от попадания влаги и использовать только вместе с данным аппаратом.
13. При повреждении соединительного кабеля использование блока питания запрещается.
14. Работы по ремонту и техническому обслуживанию аппарата разрешается выполнять только авторизованным специалистам сервисной службы.

2.1 Функциональное предназначение

Аппарат служит вспомогательным средством для дозирования жидкостей градуированными и мерными пипетками из стекла или пластмассы в диапазоне объемов от 0,1 мл до 200 мл при наружном диаметре всасывающей трубки < 9,2 мм. При правильном обращении дозируемая жидкость вступает в контакт только с пипеткой.

2.2 Ограничения по применению

Устройство используется для дозирования жидкостей с учетом следующих физических ограничений:

- от +10 °C до +40 °C (от 50 °F до 104 °F) (аппарат и реагент)

- Давление пара до макс. 500 мбар. При давлении выше 300 мбар всасывать следует медленно, чтобы избежать кипения жидкости.
- Плотность до 9 г/см³

2.3 Запреты на использование

Запрещается использовать аппарат для жидкостей, пары которых вызывают коррозию или воздействуют на материалы из силикона или ЭПДМ.

Устройство не пригодно для использования с пипетками Пастера.

ПРЕДУПРЕЖДЕНИЕ



Эксплуатация аппарата во взрывоопасной среде

Эксплуатация или зарядка аппарата во взрывоопасной среде запрещены. Запрещается дозировать легковоспламеняющиеся среды (температура воспламенения ниже 0 °C (32 °F), например, эфир, ацетон).

2.4 Условия хранения

Аппарат и принадлежности следует хранить в чистом виде только в сухом прохладном месте.

Температура хранения: от -20 °C до +50 °C (от -4 °F до 122 °F).

Относительная влажность: от 5 % до 95 %.

3 Функциональные элементы и органы управления

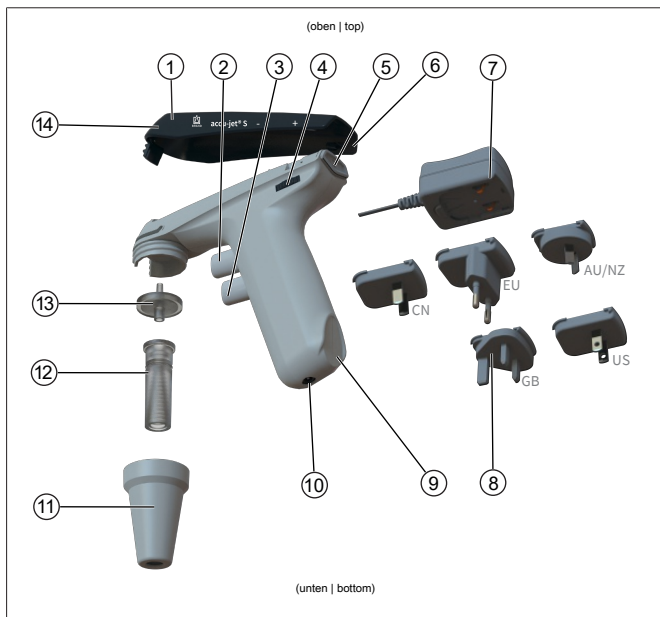

- | | |
|--|---|
| 1 Верхний элемент корпуса | 2 Верхняя кнопка пипетирования (наби-
рание жидкости) |
| 3 Нижняя кнопка пипетирования (дози-
рование жидкости) | 4 Дисковый регулятор частоты враще-
ния двигателя |
| 5 Переключатель режима работы | 6 Основание верхнего элемента корпуса |
| 7 Блок питания | 8 Адаптер для страны |
| 9 Основание рукоятки | 10 Гнездо для зарядки |
| 11 Корпус адаптера (PP) | 12 Адаптер/обратный клапан (SI/PTFE) |
| 13 Мембранный фильтр (PP/PTFE) | 14 Отверстие для выравнивания давлe-
ния |

Информацию о напряжении и потребляемом токе см. в гл. Технические данные, Страница 262 .

Сокр.	Материал
PP	полипропилен
PTFE	политетрафторэтилен
SI	силикон

4 Ввод в эксплуатацию

4.1 Подключение аккумулятора

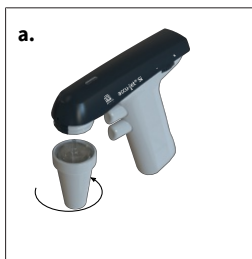

- a.** Отверните винты корпуса адаптера. Адаптер и фильтр остаются в корпусе адаптера.

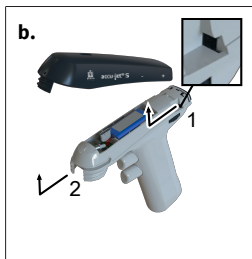

- b.** Снять корпус. Слегка сдвиньте корпус в направлении резьбового соединения корпуса адаптера.
- ⇒ Корпус выходит из выемок над дисковым регулятором (1) и из резьбового соединения корпуса адаптера (2).
- ⇒ Становится виден отсек для аккумуляторной батареи.

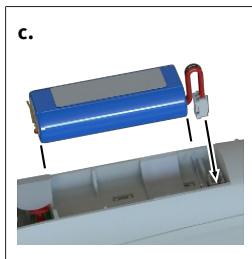

- c.** Взять вилку кабеля аккумуляторной батареи, сориентировать ее соответствующим образом и плотно вставить в гнездо до щелчка. Вложить аккумулятор.

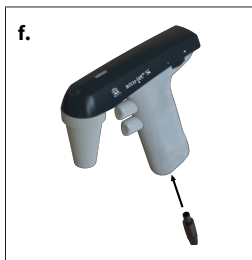
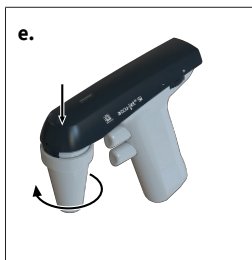
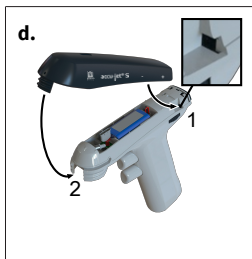

d. Установить корпус. Убедитесь, что корпус входит в выемки над дисковым регулятором (1) и в резьбовое соединение корпуса адаптера (2).

e. Вдавить верхнюю часть корпуса в оболочки корпуса и привинтить корпус адаптера.

f. Заряжать аккумулятор до тех пор, пока светодиодный индикатор заряда не начнет мигать зеленым цветом. Время зарядки ок. 4 часов, см. гл. Зарядка аккумулятора.

4.2 Зарядка аккумулятора

⚠ ПРЕДУПРЕЖДЕНИЕ



Поврежденный блок питания или зарядный кабель

Опасность травмирования от поражения электрическим током.



- > Не допускается использование поврежденного блока питания.
- > При повреждении зарядного кабеля использование блока питания не допускается.

УКАЗАНИЕ

Использовать только оригинальный блок питания изготовителя!

Использование иного блока питания может привести к повреждению аппарата и аккумуляторной батареи.

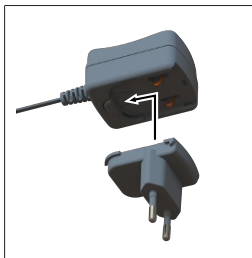

- a. Адаптер для конкретной страны присоединить к блоку питания.
 - b. Блок питания подключить к аппарату.
 - c. Подключить блок питания к сетевой вилке.
- ⇒ Выполняется зарядка аппарата. Это видно по светодиодному индикатору зарядки на верхней части корпуса. Продолжительность работы и время зарядки см. в разделе Технические данные, Страница 262 .

Светодиодный индикатор зарядки	Статус	Что делать?
Зеленый: мигающий	Аккумулятор заряжен. Выполняется постоянная подзарядка.	С аппаратом можно работать. Аппарат полностью заряжен.

Светодиодный индикатор зарядки	Статус	Что делать?
Зеленый: постоянно светящийся	Аккумулятор заряжается	Вы можете продолжать работу даже во время зарядки.
Красный: мигающий	Аккумулятор почти разряжен.	Прекратите работу с аппаратом. Зарядите аккумулятор. Вы можете продолжать работу даже во время зарядки.
Красный: постоянно светящийся	Аккумулятор разряжен.	Зарядите аккумулятор.

УКАЗАНИЕ

- Постоянная подзарядка предотвращает избыточный заряд и сводит к минимуму эффект инерции батареи. Для сохранения максимальной емкости заряжайте аккумулятор только тогда, когда на это указывает светодиодный индикатор заряда.

4.3 Запуск устройства

После установки заряженной батареи аппарат готов к работе. Переключатель ВКЛ/ВЫКЛ отсутствует.

4.4 Выбор режима работы

Переключатель, см. Функциональные элементы и органы управления, Страница 246

Режим работы «Свободный слив»: переместить переключатель вверх.

Режим работы «Продувка с помощью двигателя»: сдвинуть переключатель вниз.

4.5 Всасывание или дозирование жидкости

Кнопка пипетирования, см. гл. Функциональные элементы и органы управления, Страница 246

Для наполнения пипетки нажать верхнюю кнопку пипетирования, а для дозирования - нижнюю кнопку пипетирования.

4.6 Изменение скорости дозирования

Скорость ограничивается заданной максимальной частотой вращения двигателя. Чем дальше нажата верхняя или нижняя кнопка пипетирования, тем быстрее происходит всасывание или дозирование жидкости.

4.7 Установка частоты вращения двигателя

Дисковый регулятор, см. Функциональные элементы и органы управления, Страница 246

Поворотом дискового регулятора можно плавно регулировать частоту вращения двигателя от максимальной (+) до минимальной (-). Мы рекомендуем максимальную скорость двигателя для пипеток большого объема и более низкую скорость двигателя для пипеток малого объема.

4.8 Хранение аппарата

4.8.1 Укладка на стол

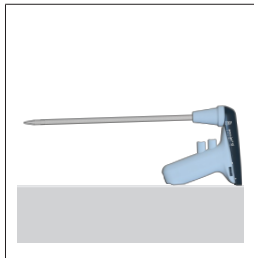

Аппарат accu-jet® S можно положить на ровную поверхность со вставленной пипеткой.

4.8.2 Настенное крепление



- a. Очистить поверхность крепления подходящим чистящим средством (не использовать оставляющие жирные разводы бытовые чистящие средства) и безворсовой тканью и дайте полностью высохнуть.
- b. Снять защитную пленку с клейкой ленты
- c. Настенное крепление **плотно** прижать к поверхности для крепления.

5 Пипетирование

1. Присоединение пипетки

⚠ ПРЕДУПРЕЖДЕНИЕ



Следить за прочной посадкой пипетки. Никогда не применяйте силу! Особенно при использовании тонких пипеток существует риск разбить стекло! Опасность получения травмы!



- a. Всегда следует держать пипетку как можно ближе к верхнему концу и осторожно вставлять ее в адаптер до плотного прилегания.
- b. Аппарат с вставленной пипеткой всегда следует держать вертикально, наконечником вниз.

2. Наполнение пипетки

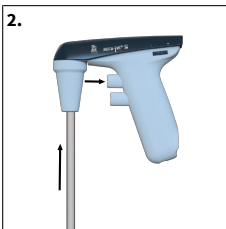

- a. Погрузить наконечник пипетки в жидкость.
- b. Медленно надавить на верхнюю кнопку пипетирования и наполните пипетку так, чтобы уровень был немного выше нужных отметок.
- c. При нажатии обеих кнопок пипетирования можно очень чувствительно всасывать или дозировать жидкость. Это особенно полезно при

регулировке уровня или использовании пипеток с небольшим объемом.

УКАЗАНИЕ

Переполнение пипетки не допускается.

3. Установка объема

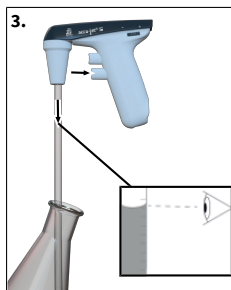

- a. При необходимости протереть наконечник пипетки подходящей безворсовой тканью.
- b. Медленно нажать нижнюю кнопку пипетирования и дозировать жидкость до установки уровня на нужной отметке.

4. Опорожнение пипетки

- a. Медленно нажать нижнюю кнопку пипетирования. Скорость дозирования зависит от того, насколько сильно вдавлены кнопки пипетирования. В режиме работы "продувка с помощью двигателя" скорость дозирования зависит также от настроенной скорости двигателя.

5. После пипетирования

- a. Захватить пипетку как можно выше и вытянуть ее из адаптера.

6 Очистка

УКАЗАНИЕ

accu-jet® S не подлежит обработке в автоклаве

Периодически необходимо протирать детали корпуса влажной тканью. При правильной эксплуатации аппарат не требует технического обслуживания.

6.1 Проверка плотности

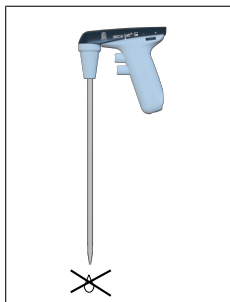

После регулировки уровня жидкость не должна капать из пипетки без срабатывания клапанов. Если из пипетки капает, см. Неисправность - что делать?

6.2 Замена фильтра и очистка адаптера

⚠ ПРЕДУПРЕЖДЕНИЕ



Опасность загрязнения и инфицирования

Носить защитные перчатки и защитные очки.



УКАЗАНИЕ

Замена фильтра или очистка необходимы только в случае переполнения дозатора или ухудшения эффективности всасывания.

b.



- a.** Вытянут пипетку.
- b.** Отверните винты корпуса адаптера.
- c.** Снять верхнюю часть корпуса.

d.



- d.** Вытолкнуть адаптер и мембранный фильтр из конусной части корпуса адаптера.

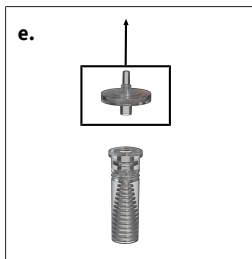

e. Извлечь дефектный мембранный фильтр.

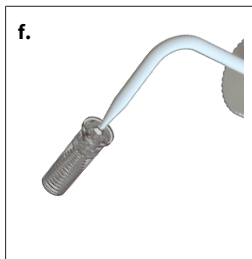

f. Для очистки тщательно промыть адаптер, используя бутылку с распылителем, наполненную подходящей чистящей жидкостью, например, водой. Затем продуть его и высушить.

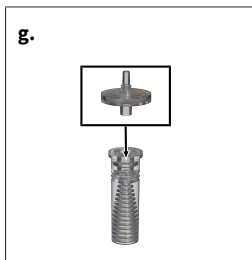

g. Сначала вдавить новый мембранный фильтр в адаптер более толстым соединением вниз (более тонкая коническая сторона направлена вверх), а затем вставить его в корпус адаптера.

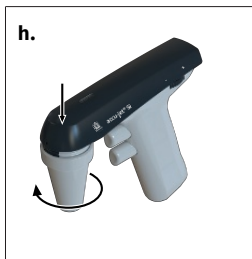

- h. Вдавить верхнюю часть корпуса в оболочку корпуса и привинтить корпус адаптера.

УКАЗАНИЕ

Примечание по автоклавируемым фильтрам

В каждом конкретном случае пользователь должен проверять эффективность обработки в автоклаве. Не каждый мембранный фильтр подходит! Использовать только оригинальные принадлежности.

- > В стандартной комплектации аппарат оснащен мембранным фильтром 0,2 мкм (красный цветовой код).
- > Мембранный фильтр можно обрабатывать в автоклаве до пяти раз при температуре 121 °C (250 °F).
- > При использовании мембранных фильтров 0,2 мкм (для клеточных культур) можно достичь допусков по объему класса B.
- > Для соблюдения допусков по объему класса A требуются мембранные фильтры 3 мкм. Из-за большего размера пор они меньше влияют на время свободного дозирования пипеток, см. .

6.3 УФ-стерилизация

Аппарат устойчив к обычному воздействию бактерицидной УФ-лампы. В результате воздействия ультрафиолета возможно изменение цвета.

7 Неисправность - что делать?

Неисправность	Причина	Что делать?
Снижена эффективность всасывания	Понижена частота вращения двигателя	Увеличить частоту вращения двигателя, см. Установка частоты вращения двигателя, Страница 252
	Закрыт обратный клапан	Установить переключатель в положение продувки и нажать нижнюю кнопку пипетирования, см. Выбор режима работы, Страница 251
Из пипетки капает	Неправильная посадка фильтра	Правильно установить фильтр, см. гл. Замена фильтра и очистка адаптера, Страница 257
	Повреждение адаптера или пипетки	Заменить адаптер или пипетку, см. гл. Замена фильтра и очистка адаптера, Страница 257 .
Пипетка не держится правильно в адаптере	Адаптер загрязнен или поврежден	Очистить адаптер, высушить воздухом и при необходимости заменить, см. гл. Замена фильтра и очистка адаптера, Страница 257
Светодиодный индикатор заряда не горит/мигает после подключения блока питания и подачи электропитания.	Разъем аккумулятора вставлен неплотно	Плотно вставить разъем аккумулятора, см. гл. Подключение аккумулятора, Страница 248
	Несоответствующий блок питания	Использовать только оригинальный блок питания, см. гл. Функциональные элементы и органы управления, Страница 246
	Дефект аккумулятора или блока питания	Заменить аккумулятор/блок питания
	Аппарат неисправен	Отправить аппарат для ремонта, см. Ремонт, Страница 264
Малая емкость аккумулятора	Аккумулятор неисправен	Заменить аккумуляторную батарею, см. гл. Подключение аккумулятора, Страница 248
Аппарат не работает	Внутренняя ошибка (выполнить сброс)	Отсоединить разъем аккумуляторной батареи и удерживать одну кнопку пипетирования в течение 10 сек. После этого снова плотно вставить разъем аккумулятора, см. гл. Подключение аккумулятора, Страница 248 и Пипетирование, Страница 254

Если вы не можете решить проблему с помощью приведенной выше таблицы неисправностей, обратитесь к своему специализированному дилеру или непосредственно к производителю.

8 Технические данные

Технические данные	Значения
Гнездо для зарядки	5 В пост. тока
Блок питания	Вход: 100 – 240 В перем.тока, 50/60 Гц Выход: 5 В пост. тока
Аккумулятор	Аккумулятор NiMH 2,4 В, 730 мАч Время зарядки: 4 ч Максимальное время работы: ок. 8 ч Температура зарядки: от +10 °С до +35 °С

8.1 Маркировка на изделии

Знак или номер	Значение
XXZXXXXX	Серийный номер
QR-код	Содержит серийный номер
	Этим знаком мы подтверждаем, что продукт соответствует требованиям, изложенным в директивах ЕС, и прошел указанные процедуры испытаний.
	UKCA: United Kingdom Conformity Assessed Этим знаком мы подтверждаем, что продукт соответствует требованиям, изложенным в установленных UK Designated Standards стандартах.
www.brand.de/ip	Патентная информация
 (здесь: 40 лет)	Китайская Директива об ограничении применения опасных веществ в электрических и электронных приборах -China RoHS (EFUP) EFUP определяет срок в годах, в течение которого опасные вещества, содержащиеся в электрическом и электронном оборудовании, не вытекают и не изменяются при нормальных условиях эксплуатации. При нормальном использовании пользователем такие электрические и электронные изделия не вызывают серьезного загрязнения окружающей среды, серьезных физических травм или повреждения имущества пользователя.

Знак или номер	Значение
	Данный электрический аппарат нельзя выбрасывать вместе с бытовыми отходами.

9 Ремонт

9.1 Отправка для ремонта

УКАЗАНИЕ

Перевозка опасных материалов без разрешения запрещена законом.

Аппарат необходимо тщательно очистить и обеззаразить!

- При возврате изделий всегда необходимо указывать точное описание типа неисправности и использованного носителя. При отсутствии сведений об использованном носителе ремонт устройства невозможен.
- Отправляйте аппарат только без аккумуляторной батареи.
- Риски и расходы по обратной транспортировке ложатся на заказчика.

Кроме США и Канады

заполнить «Декларацию об отсутствии риска для здоровья» и отправить ее вместе с аппаратом производителю или продавцу. Формы документа можно запросить у продавца или производителя или скачать на сайте www.brand.de.

Для США и Канады

Прежде чем отправлять прибор на сервисное обслуживание уточните в компании BrandTech Scientific, Inc. требования к возврату.

Очищенные и обеззараженные устройства отправляйте только по адресу, который вы получили вместе с номером на возврат изделия. Номер на возврат изделия нанести на внешней стороне упаковки так, чтобы он был хорошо виден.

Контактные адреса

Германия:

BRAND GMBH + CO KG
Otto-Schott-Straße 25
97877 Wertheim (Германия)
Тел.: +49 9342 808 0
Факс: +49 9342 808 98000
info@brand.de
www.brand.de

США и Канада

BrandTech® Scientific, Inc.
11 Bokum Road
Essex, CT 06426-1506 (USA)
Тел.: +1-860-767 2562
Факс: +1-860-767 2563
info@brandtech.com
www.brandtech.com

Индия:

BRAND Scientific Equipment Pvt. Ltd.
303, 3rd Floor, 'C' Wing, Delphi
Hiranandani Business Park,
Powai
Mumbai-400 076 (India)
Тел.: +91 22 42957790
Факс: +91 22 42957791
info@brand.co.in
www.brand.co.in

Китай:

BRAND (Shanghai) Trading Co., Ltd.
Guangqi Culture Plaza
Room 506, Building B
No. 2899, Xietu Road
Shanghai 200030 (P.R. China)
Тел.: +86 21 6422 2318
Факс: +86 21 6422 2268
info@brand.com.cn
www.brand.cn.com

10 Информация для заказа

10.1 Аппарат

Цвет верхней части корпуса	№ для заказа (с универсальным блоком питания и с адаптером страны покупателя)	№ для заказа (без универсального блока питания и без адаптера страны покупателя)
Anthrazit	26350	26360
Beere	26351	26361
Petrol	26352	26362
Amethyst	26353	26363

Комплект поставки, см. главу . Учитывайте номера заказов, с блоком питания или без него.

10.2 Запасные части

Запасной мембранный фильтр

Описание	Упаков.един.	№ для заказа
0,2 мкм, стерильный (красный цветовой код)	1 шт. в блистерной упаковке	26530
0,2 мкм	10 шт. в полиэтиленовом пакете	26535
3 мкм	1 шт. в блистерной упаковке	26052
3 мкм	10 шт. в полиэтиленовом пакете	26056

Блок питания

Технические данные блока питания, см. гл Технические данные, Страница 262 .

Тип	№ для заказа
Блок питания с адаптером страны покупателя	26606

Аккумулятор

Технические данные аккумуляторной батареи см. гл Технические данные, Страница 262 .

Описание	№ для заказа
Аккумуляторная батарея NiMH	26630

Силиконовый адаптер с обратным клапаном

Описание	№ для заказа
Силиконовый адаптер	26508

Корпус адаптера

Цвет	№ для заказа
белый	26658

Настенное крепление

Цвет	№ для заказа
белый	26539

Клейкая лента

Упаков. един.	№ для заказа
3 комплекта	26547

11 Ответственность за дефекты

Мы не несем ответственности за последствия неправильного обращения, использования, технического обслуживания, эксплуатации или несанкционированного ремонта устройства или за последствия естественного износа, в частности изнашиваемых деталей, таких как поршни, уплотнения, клапаны, а также случаи разбития стекла. Это же касается и несоблюдения инструкции по эксплуатации. В особенности, мы не несем ответственности за ущерб, причиненный в случае, если аппарат был разобран более детально, чем описано в инструкции по эксплуатации, или если были установлены принадлежности или запасные части сторонних производителей.

США и Канада

Информацию об ответственности за дефекты можно найти на сайте www.brandtech.com.

12 Утилизация



Расположенный рядом символ означает, что батареи/аккумуляторы и электронные устройства по окончании срока службы подлежат утилизации отдельно от бытовых отходов (несортированных бытовых отходов).

Согласно Директиве 2012/19/ЕС Европейского парламента и Совета от 4 июля 2012 г. об отходах электрического и электронного оборудования, электронные устройства подлежат утилизации надлежащим образом в соответствии с национальными правилами утилизации.

Батареи и аккумуляторы содержат вещества, которые могут оказывать вредное воздействие на окружающую среду и здоровье человека. Поэтому согласно Директиве 2006/66/ЕС Европейского парламента и Совета от 6 сентября 2006 г. о батареях и аккумуляторах они подлежат утилизации надлежащим образом в соответствии с национальными правилами утилизации. Утилизировать только полностью разряженные батареи и аккумуляторы.

EU-Konformitätserklärung | EU Declaration of Conformity

Produktbezeichnung: Product name:	Pipettierhelfer accu-jet® S / Pipetting controller accu-jet® S
Produktvarianten: Product variations:	Anthrazit, Beere, Petrol, Amethyst / anthracite, berry, petrol, amethyst
Art-Nr. / Cat.-No.	26350, 26351, 26352, 26353, 26360, 26361, 26362, 26363

Das oben beschriebene Produkt entspricht den grundlegenden Anforderungen, die in den nachfolgend bezeichneten Harmonisierungsrechtsvorschriften festgelegt sind: The product described above meets the basic requirements that are specified in the harmonization legislation listed below:	Angewendete harmonisierte Normen: Applied harmonized standards:
RoHS: 2011/65/EU incl.2015/863/EU EMC: 2014/30/EU	EN IEC 63000:2018 EN 61326-1:2013
Weitere angewendete Normen: Other applied standards:	Geltungsbereich: Scope:
EN 61010-1:2010, EN 61010-1:2010/A1:2019/AC:2019-04 EN/IEC 62368-1:2014 (angewendet auf Fremdherstellernetzteil / applied to third-party power supply)	NRL / LVD NRL / LVD

Die alleinige Verantwortung für die Ausstellung dieser Konformitätserklärung in Bezug auf die Erfüllung der grundlegenden Anforderungen und die Anfertigung der technischen Unterlagen trägt der Hersteller.

The manufacturer is solely responsible for issuing this declaration of conformity with regard to meeting the essential requirements and preparing the technical documentation.

Hersteller / Manufacturer	Adresse / Address
BRAND GMBH + CO KG	Otto-Schott-Str. 25 97877 Wertheim Germany

Wertheim, 01. Juli 2022 / 01 July 2022



Patrick Ziemeck
Managing Director Technology



i.A. Siegfried Ott
Regulatory Affairs

Diese Erklärung bescheinigt die Übereinstimmung mit den genannten Harmonisierungsvorschriften, beinhaltet jedoch keine Zusicherung von Eigenschaften.

This document declares the accordance with the named harmonized regulations, but does not assure specific properties.

UK Declaration of Conformity

Product name: Pipetting controller accu-jet® S
Product variations: anthracite, berry, petrol, amethyst
Cat.-No. 26350, 26351, 26352, 26353, 26360, 26361, 26362, 26363

The product described above meets the basic requirements that are specified in the harmonization legislation listed below:	Applied harmonized standards:
The Restriction of the Use of Certain Hazardous Substances in Electrical and Electronic Equipment Regulations 2012 (SI 2012 No. 3032)	EN IEC 63000:2018
Electromagnetic Compatibility Regulations 2016 (SI 2016 No. 1091, as amended by SI 2019 No. 696)	EN 61326-1:2013
Other applied standards:	Scope:
EN 61010-1:2010, EN 61010-1:2010/A1:2019/AC:2019-04 EN/IEC 62368-1:2014 (angewendet auf Fremdherstellernetzteil / applied to third-party power supply)	LVD LVD

The manufacturer is solely responsible for issuing this declaration of conformity with regard to meeting the essential requirements and preparing the technical documentation.

Manufacturer	Address
BRAND GMBH + CO KG	Otto-Schott-Str. 25 97877 Wertheim Germany

Wertheim, 18 February 2022



Patrick Ziemeck
Managing Director Technology



i.A. Siegfried Ott
Regulatory Affairs

This document declares the accordance with the named harmonized regulations, but does not assure specific properties.

Declaration of conformity – China RoHS 2

BRAND GMBH + CO KG has made reasonable efforts to ensure that hazardous materials and substances may not be used in BRAND products.

In order to determine the concentration of hazardous substances in all homogeneous materials of the subassemblies, a “Product Conformity Assessment” (PCA) procedure was performed. As defined in GB/T 26572 the “Maximum Concentration Value” limits (MCV) apply to these restricted substances:

+ Lead (Pb):	0.1%	+ Hexavalent chromium (Cr(+VI)):	0.1%
+ Mercury (Hg):	0.1%	+ Polybrominated biphenyls (PBB):	0.1%
+ Cadmium (Cd):	0.01%	+ Polybrominated diphenyl ether (PBDE):	0.1%

Environmental Friendly Use Period (EFUP)

EFUP defines the period in years during which the hazardous substances contained in electrical and electronic products will not leak or mutate under normal operating conditions. During normal use by the user such electrical and electronic products will not result in serious environmental pollution, cause serious bodily injury or damage to the user's assets.

The Environmental Friendly Use Period for BRAND instruments is 40 years.



Material Content Declaration for BRAND Products

部件名称 Part name	有毒有害物质或元素 Hazardous substances					
	铅 Pb	汞 Hg	镉 Cd	六价铬 Cr(+VI)	多溴联苯 PBB	多溴二苯醚 PBDE
包装 / Packaging	0	0	0	0	0	0
塑料外壳 / 组件 Plastic housing / parts	0	0	0	0	0	0
电池 / Battery	0	0	0	0	0	0
玻璃 / Glass	0	0	0	0	0	0
电子电气组件 Electrical and electronic parts	X	0	0	0	0	0
金属外壳 / 组件 Metal housing / parts	X	0	0	0	0	0
电机 / Motor	X	0	0	0	0	0
配件 / Accessories	X	0	0	0	0	0
此表格是按照SJ/T 11364-2014中规定所制定的。 This table is created according to SJ/T 11364-2014.						

- O: 表示该有毒有害物质在该部件所有均质材料中的含量均在GB/T 26572规定的限量要求以下。
- O: Indicates that the above mentioned hazardous substance contained in all homogeneous materials of the part is below the required limit as defined in GB/T 26572.
- X: 表示该有毒有害物质至少在该部件某一均质材料中的含量超出GB/T 26572规定的限量要求。
- X: Indicates that the above mentioned hazardous substance contained in at least one of the homogeneous materials of this part is above the required limit as defined in GB/T 26572.

注释： 电池，玻璃制品和配件可能不属于此设备的一部分且/或可能有它自己的EFUP标志且/或可能包含更改EFUP标志的部件。

Note: Batteries, glassware and accessories might not be content of the enclosed device and/or may have their own EFUP-marking and/or might be maintaining parts with changing EFUP-marking.

除上表所示信息外，还需声明的是，这些部件并非是有用铅 (Pb), 汞 (Hg), 镉 (Cd), 六价铬 (Cr(+VI)), 多溴联苯 (PBB) 或多溴二苯醚 (PBDE) 来制造的。

Apart from the disclosures in the above table, the subassemblies are not intentionally manufactured or formulated with lead (Pb), mercury (Hg), cadmium (Cd), hexavalent chromium (Cr+VI), polybrominated biphenyls (PBB), and polybrominated diphenyl ethers (PBDE).

Products manufactured by BRAND may enter into further devices or can be used together with other appliances. With these third party products and appliances in particular, please note the EFUP labeled on these products. BRAND will not take responsibility for the EFUP of those products and appliances.

Place, date: Wertheim, 05|04|2022



Patrick Ziemeck
(Managing Director Technology)



i.A. Siegfried Ott
(Regulatory Affairs)

목차

1 서문	276
1.1 공급 범위.....	276
1.2 사용 규정.....	276
2 안전	278
2.1 기능.....	279
2.2 사용 한계.....	279
2.3 사용 제외.....	279
2.4 보관 조건.....	280
3 기능 및 조작 요소	281
4 시동	283
4.1 배터리 연결.....	283
4.2 배터리 충전.....	285
4.3 장치 시작.....	286
4.4 작동 모드 선택하기.....	286
4.5 액체 흡입 또는 배출.....	286
4.6 피펫 속도 변경.....	287
4.7 엔진 회전속도 조정.....	287
4.8 장치 보관.....	287
5 피펫팅	289
6 세척	291
6.1 누설 점검.....	291
6.2 필터 교환 및 어댑터 세척.....	291
6.3 UV 소독.....	294
7 장애 - 문제 해결?	295
8 기술 데이터	296
8.1 제품 표시.....	296
9 수리	297
9.1 수리를 위해 보내기.....	297

10 주문 정보	299
10.1 장치.....	299
10.2 예비 부품.....	299
11 결함에 대한 책임.....	301
12 폐기.....	302

1 서문

1.1 공급 범위

Pipetting aid, 니켈-메탈 하이브리드 배터리, 옵션인 전원장치(다양한 주문 번호에 유의), 예비 0.2 μ m 다이어프램 필터 2개사다리 브래킷, 사용 설명서

1.2 사용 규정

- 최초 사용 전 사용 설명서를 숙독하십시오.
- 사용 설명서는 장치의 구성요소이며 쉽게 접근 가능하도록 보관해야 합니다.
- 본 장치를 제3자에게 전달할 때는 본 사용 설명서를 함께 전달하십시오.

1.2.1 위험 단계

다음 신호어로 가능한 위험이 표시됩니다.

신호어	의미
위험	심각한 부상 또는 사망을 야기합니다.
경고	심각한 부상 또는 사망을 야기할 수 있습니다.
주의	가벼운 부상 또는 중증도의 부상을 야기할 수 있습니다.
참고	물적 손상이 유발될 수 있습니다.

1.2.2 사용 설명서의 기호

기호	의미	기호	의미
	위험 장소		폭발 위험

기호	의미	기호	의미
	보안경 착용		보호장갑 착용

1.2.3 표시

표시	의미	표시	의미
1. Task	작업을 표시합니다.	>	전제 조건을 표시합니다.
a., b., c.	작업의 개별적인 단계를 표시합니다.	⇨	결과를 나타냅니다.

2 안전

반드시 숙지하십시오!

accu-jet® S 실험실 도구는 위험한 물질, 작업 과정 및 장치와 함께 사용될 수 있습니다. 그러나 사용 설명서는 사용 시 발생할 수 있는 모든 안전 문제를 보여줄 수 없습니다. 사용자에게는 안전 및 건강 규정 준수를 확인하고 사용 전 해당 제한 사항을 확정해야 할 책임이 있습니다.

1. 모든 사용자는 본 사용 설명서를 장치 사용 전 읽었어야 하며 준수해야 합니다.
2. 일반 위험 지침 및 안전 지침을 따르십시오(예: 보호장간, 보안경, 장갑 착용).
3. 시약 제조사의 기재 정보에 유의하십시오.
4. 장치를 폭발 위험이 있는 대기에서 작동하거나 경성 인화제를 피펫팅하지 마십시오.
5. 장치는 정의된 사용 한계 내에서만 액체 피펫팅에만 사용하십시오. 사용 제외 조건에 유의하십시오(사용 제외, 페이지 279 참조)! 의심스러운 부분이 있는 경우 반드시 제조사 또는 대리점에 문의하십시오.
6. 항상 사용자와 다른 인원이 위험해지지 않도록 작업하십시오. 물방울을 피하십시오. 적합한 용기를 사용하십시오.
7. 힘을 가하지 마십시오.
8. 순정 부속품 및 순정 예비 부품만 사용하십시오. 기술적 변경을 수행하지 마십시오. 장치를 사용 설명서에 설명된 것 이상으로 분해하지 마십시오.
9. 사용 전 장치의 정상 작동 상태를 확인하십시오. 장치에 장애가 있는 것을 알게 되면 즉시 피펫팅을 중지하고 Störung - Was tun? 장을 따르십시오. 경우에 따라 제조사에 문의하십시오.
10. 니켈-메탈 하이브리드 배터리 충전 시에는 순정 전원장치만 사용하십시오.
11. 배터리를 다른 제조사의 배터리로 교체하지 마십시오.
12. 전원장치는 습기로부터 보호해야 하며 본 장치와 함께만 작동해야 합니다.

13. 연결 케이블이 손상된 경우 전원장치를 더 이상 사용하지 마십시오.
14. 수리 및 제품에 대한 개입은 인증된 서비스 기술자만 수행해야 합니다.

2.1 기능

본 장치는 부피가 0.1ml~200ml이거나 흡입관 외부 직경이 9.2mm 미만 인 유리 또는 플라스틱 재질의 측정 및 눈금 피펫을 사용한 액체 피펫팅의 보조 도구를 사용합니다. 올바르게 취급하는 경우 피펫팅된 액체는 피펫과만 접촉합니다.

2.2 사용 한계

본 장치는 다음과 같은 물리적 한계를 준수한 상태에서 액체 피펫팅에 사용됩니다.

- +10°C ~ +40°C (50°F ~ 104°F) (장치 및 시약)
- 증기압은 최대 500mbar. 300mbar 이상에서는 액체의 비등을 방지하기 위해 천천히 흡입하십시오.
- 밀도는 최대 9g/cm³

2.3 사용 제외

본 장치는 그 증기가 부식 작용을 하거나 실리콘 또는 EPDM 물질을 부식시키는 액체에는 사용하지 않습니다.

본 장치는 파스퇴르 피펫과 함께 사용하기에는 적합하지 않습니다.

⚠ 경고



폭발 위험이 있는 환경에서의 장치 작동

본 장치는 폭발 위험이 있는 환경에서 작동하거나 로드해서는 안 됩니다. 가연성 매체를 피펫팅해서는 안 됩니다(인화점이 0°C(32°F) 미만인 매체, 예: 에테르, 아세톤).

2.4 보관 조건

장치 및 부속품은 세척된 상태에서만 서늘하고 건조한 장소에 보관하십시오.

보관 온도: -20°C ~ 50°C(-4°F ~ 122°F).

상대 공기 습도: 5% ~ 95%

3 기능 및 조작 요소

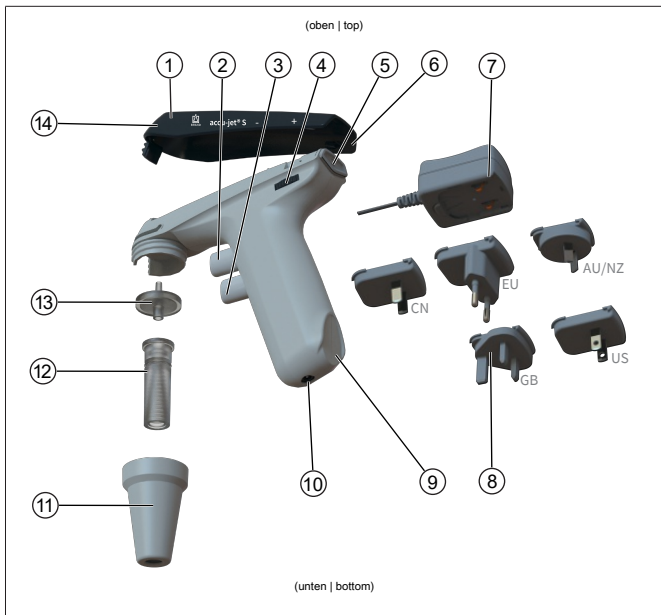

- | | |
|----------------------|-----------------------|
| 1 하우징 전면 케이스 | 2 상부 피펫팅 버튼(액체 흡입) |
| 3 하부 피펫팅 버튼(액체 배출) | 4 모터 속도 조정 휠 |
| 5 작동 모드 선택 스위치 | 6 하우징 전면 케이스 거치면 |
| 7 전원장치 | 8 국가별 어댑터 |
| 9 손잡이 거치면 | 10 충전소켓 |
| 11 어댑터 하우징(PP) | 12 어댑터/체크 밸브(SI/PTFE) |
| 13 다이어프램 필터(PP/PTFE) | 14 압력 평형 개구 |

전압 및 소비 전력에 관한 정보는 기술 데이터, 페이지 296 를 참조하십시오.

약어	재료
PP	폴리프로필렌

3 기능 및 조작 요소

약어	재료
PTFE	폴리테트라플루오르에틸렌
서비스 인포 메이션	실리콘

4 시동

4.1 배터리 연결

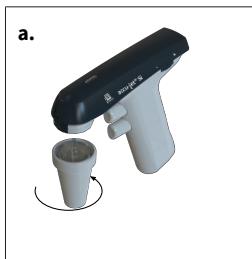

- a.** 어댑터 하우징을 분리하십시오. 어댑터와 필터는 어댑터 하우징에 남아 있습니다.

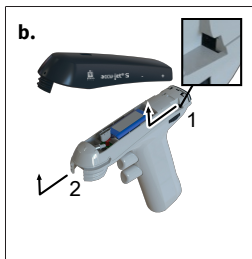

- b.** 하우징을 빼내십시오. 어댑터 하우징의 나사 체결부 방향으로 하우징을 가볍게 밀니다.
- ⇒ 하우징이 조정 휠(1) 위 및 어댑터 하우징(2)의 나사 체결부에서 분리됩니다.
- ⇒ 배터리 컴파트먼트가 보입니다.

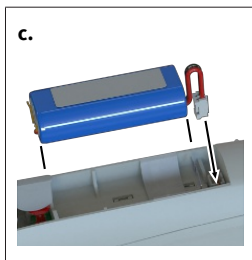

- c.** 케이블의 배터리 플러그를 잡고 적절하게 정렬하고 소리를 내며 고정될 때까지 소켓에 단단히 끼우십시오. 배터리를 넣으십시오.

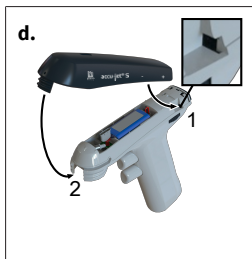

- d. 하우징을 끼우십시오. 이때 하우징이 조정 휠(1) 위의 지정된 홈 및 어댑터 하우징(2)의 나사 체결부와 맞물려야 함에 유의하십시오.

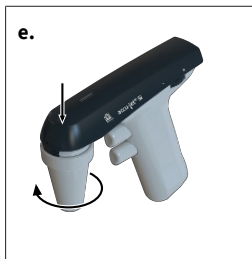

- e. 하우징 상부를 하우징 셸 안으로 누르고 어댑터 하우징을 끼우십시오.

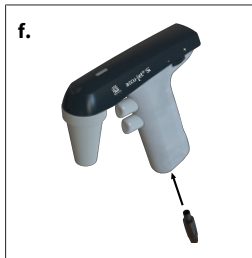

- f. LED 충전 표시등이 녹색으로 점멸할 때까지 배터리를 충전하십시오. 충전 시간은 약 4시간입니다(배터리 충전 참조).

4.2 배터리 충전

⚠ 경고



손상된 전원장치 또는 충전 케이블

감전으로 인한 상해 위험'



- > 손상된 전원장치는 사용하지 마십시오.
- > 충전 케이블이 손상된 경우 전원장치를 사용하지 마십시오.

주의

제조사의 순정 전원장치만 사용하십시오!

다른 전원장치를 사용하면 장치 및 배터리가 손상될 수 있습니다.

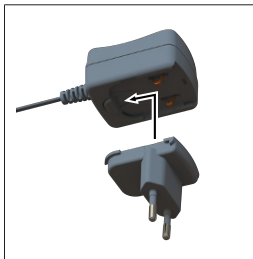

- a. 국가별 어댑터를 전원장치에 끼우십시오.
 - b. 전원장치를 장치에 연결하십시오.
 - c. 전원장치를 전원 플러그에 끼우십시오.
- ⇒ 장치가 충전됩니다. 장치가 충전되는지 여부는 하우징 상부의 LED 표시등을 통해 알 수 있습니다. 작동 시간 및 충전 시간은 기술 데이터, 페이지 296 를 참조하십시오.

LED 충전 표시등	상태	문제 해결?
녹색: 점멸	배터리가 충전되었습니다. 저속 충전이 진행되고 있습니다.	장치를 사용해 작업할 수 있습니다. 장치가 완전히 충전되었습니다.
녹색: 지속적으로 점등됨	배터리 충전 중	충전 중에도 계속 작업할 수 있습니다.
적색: 점멸	배터리가 거의 방전되었습니다.	장치를 사용한 작업을 중단하십시오. 배터리를 충전하십시오. 충전 중에도 계속 작업할 수 있습니다.

LED 충전 표시등	상태	문제 해결?
적색: 지속적으로 점등됨	배터리가 방전되었습니다.	배터리를 충전하십시오.

주의

- > 저속 충전에 의해 과충전이 방지되고 Lazy-Battery 효과가 최소화됩니다. 최대 용량을 유지하려면 LED 충전 표시등에 의해 표시된 경우에만 재충전하십시오.

4.3 장치 시작

장치는 충전된 배터리가 삽입되면 작동 준비 상태가 됩니다. ON/OFF 스위치는 없습니다.

4.4 작동 모드 선택하기

선택 스위치는(기능 및 조작 요소, 페이지 281 참조).

“자유 배출” 모드: 선택 스위치를 위로 미십시오.

“모터를 사용한 불어내기” 모드: 선택 스위치를 아래로 미십시오.

4.5 액체 흡입 또는 배출

피펫팅 버튼(기능 및 조작 요소, 페이지 281 참조)

피펫을 채우려면 상부 피펫팅 버튼을 배출하려면 하부 피펫팅 버튼을 누르십시오.

4.6 피펫 속도 변경

속도는 설정된 최대 모터 속도에 의해 제한됩니다. 상부 또는 하부 피펫팅 누르면 누를수록 액체가 더욱 빠르게 흡입되거나 배출됩니다.

4.7 엔진 회전속도 조정

조정 휠(기능 및 조작 요소, 페이지 281 참조)

엔진 회전 속도는 조정 휠을 돌려 최대(+)에서 최소(-)까지 무단으로 조정할 수 있습니다. 최대 모터 회전 속도는 대용량의 피펫에, 낮은 모터 회전 속도는 저용량의 피펫에 사용하는 것이 좋습니다.

4.8 장치 보관

4.8.1 테이블 요소

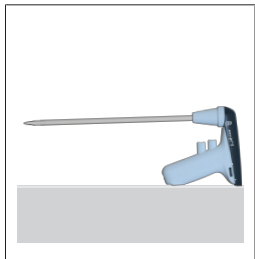

accu-jet® S은 피펫을 삽입한 상태에서 평한 바닥에 세울 수 있습니다.

4.8.2 벽 브래킷



- a. 고정면을 적합한 세제(가정용 보습 세제는 아님) 및 보풀이 없는 천으로 세척하고 철저히 건조시키십시오.
- b. 보호 필름을 접착 테이프에서 떼어 내십시오.
- c. 벽 브래킷을 고정면으로 **단단히** 누르십시오.

5 피펫팅

1. 피펫 끼우기

⚠ 경고



피펫의 올바른 위치에 유의하십시오. 힘을 가하지 마십시오! 특히 얇은 피펫의 경우 유리 파손의 위험이 있습니다! 부상 위험!

1.



- a. 피펫을 상단에 가능한 한 밀접하게 잡고 단단히 안착할 때까지 어댑터로 조심스럽게 밀어 넣으십시오.
- b. 피펫이 끼워진 장치는 항상 팁이 아래를 향한 상태에서 수직으로 유지하십시오.

2. 피펫 채우기

2.

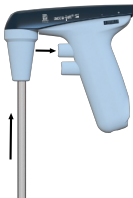

- a. 피펫 팁을 액체에 담그십시오.
- b. 상부 피펫팅 버튼을 천천히 누르고 피펫을 채워 메니스커스가 원하는 표시 위 정도에 놓이도록 하십시오.
- c. 양쪽 피펫팅 버튼을 누르면 액체를 세밀하게 흡입하거나 배출할 수 있습니다. 이는 특히 메니스커스를 조정하거나 저용량의 피펫을 사용할 때 도움이 됩니다.

주의

피펫에 과주입하지 마십시오.

3. 용량 조정

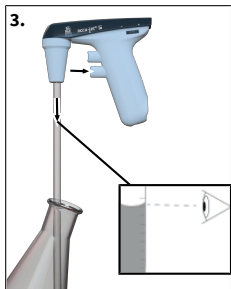

- a. 필요시 피펫 팁을 적합한 보풀이 없는 천으로 닦아주십시오.
- b. 하부 피펫팅 버튼을 천천히 누르고 메니스커스가 정확하게 원하는 표시로 조정될 때까지 배출하십시오.

4. 피펫 비우기

- a. 하부 피펫팅 버튼을 천천히 누르십시오. 피펫팅 속도는 피펫팅 버튼이 눌러지는 정도에 따라 결정됩니다. “모터를 사용한 불어내기” 모드의 경우 이는 설정된 모터 회전 속도에 따라 결정됩니다.

5. 피펫팅 이후

- a. 피펫을 가능한 한 위쪽으로 잡고 어댑터에서 빼내십시오.

6 세척

주의

accu-jet® S은 고압 살균할 수 없음

경우에 따라 하우스징 부분을 물에 적신 천으로 닦으십시오. 정상적으로 사용하는 경우 장치는 유지보수가 불필요합니다.

6.1 누설 점검

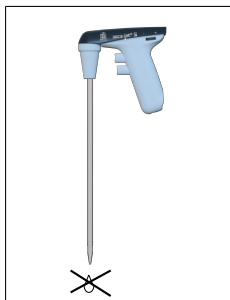

매니스커스 조정 후에는 밸브를 작동하지 않은 상태에서 피펫에서 액체가 떨어지지 않는 안 됩니다. 피펫에서 액체가 떨어지는 경우 장애 - 문제 해결?을 참조하십시오.

6.2 필터 교환 및 어댑터 세척

⚠ 경고



오염 및 감염 위험

보호장갑 및 보호경을 착용하십시오.



주의

피펫 하나가 과주입되었거나 흡입 성능이 저하된 경우에는 필터 교환 또는 세척이 필요합니다.

b.



- a. 피펫을 빼내십시오.
- b. 어댑터 하우징을 분리하십시오.
- c. 상부 하우징을 분리하십시오.

d.



- d. 어댑터 및 다이어프램 필터를 어댑터 하우징의 테이퍼 측면에서 눌러 빼내십시오.

e.



- e. 결함이 있는 다이어프램 필터를 빼내십시오.

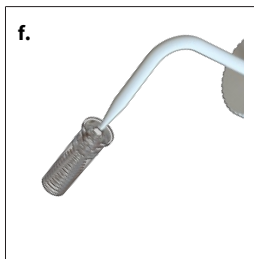

- f.** 어댑터 세척을 위해 적합한 워셔액 (예: 물)이 채워져 있는 스프레이 병을 사용하십시오. 이어서 붙어내고 건조시키십시오.

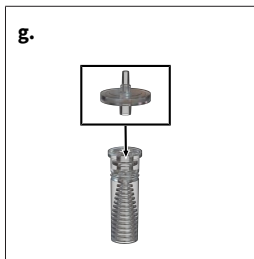

- g.** 새 다이어프램 필터의 더 두꺼운 연결부를 먼저 아래쪽으로 어댑터에 눌러 넣고(더 가는 원뿔형측이 위쪽으로) 어댑터 하우징에 끼우십시오.

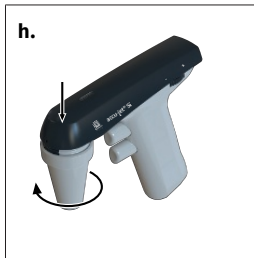

- h.** 하우징 상부를 하우징 셀 안으로 누르고 어댑터 하우징을 끼우십시오.

주의

고압 살균 가능한 필터 관련 참고 사항

고압 살균의 효과는 사용자가 각기 스스로 테스트해야 합니다. 모든 다이어프램 필터가 사용 가능하지는 않습니다! 순성 부속품만 사용하십시오.

- > 표준 사양의 장치에는 0.2 μ m 다이어프램 필터(적색 색상 코드)가 장착되어 있습니다.
- > 다이어프램 필터는 최대 5번까지 121°C(250°F)에서 고압 살균할 수 있습니다.
- > 0.2 μ m의 멤브레인 필터(cell culture용)를 사용하면 B 등급 용량 공차를 달성할 수 있습니다.
- > A 등급 용량 공차를 준수하려면 3 μ m 다이어프램 필터가 필요합니다. 이는 기공 폭이 더 넓기 때문에 피펫의 자유로운 배출 시간에 더 적은 영향을 미칩니다(참조).

6.3 UV 소독

본 장치는 UV 소독 램프의 일반적인 부하에 대한 내성이 있습니다. UV 작용으로 인해 변색은 가능합니다.

7 장애 - 문제 해결?





장애	원인	문제 해결?
흡입 성능 저하됨	엔진 회전 속도가 감소됨	엔진 회전 속도를 높이십시오(엔진 회 전속도 조정, 페이지 287 참조).
	체크 밸브 닫힘	선택 스위치를 불어내기로 설정하고 하부 피펫팅 버튼을 누르십시오(작동 모드 선택, 페이지 286 참조).
피펫에서 액체가 떨어 짐	필터가 올바르게 안착되지 않 음	필터를 올바르게 끼우십시오(필터 교 환 및 어댑터 세척, 페이지 291 참조).
	어댑터 또는 피펫 손상됨	어댑터 또는 필터를 교체하십시오(필 터 교환 및 어댑터 세척, 페이지 291 참조).
피펫이 어댑터에 고정 되지 않음	어댑터가 오염되거나 손상됨	어댑터를 세척하고 공기 건조시키거 나, 경우에 따라서는 교체하십시오(필 터 교환 및 어댑터 세척, 페이지 291 참조).
전원장치가 연결되고 전압이 공급된 후에도 LED 충전 표시등이 점 등/점멸하지 않습니다.	배터리 플러그가 단단히 끼워지지 않음	배터리 플러그를 단단히 끼우십시오 (배터리 연결, 페이지 283 참조).
	잘못된 전원장치	순정 전원장치를 사용하십시오(기능 및 조작 요소, 페이지 281 참조).
	배터리 또는 전원장치 결함	배터리/전원장치를 교환하십시오.
	장치 결함	수리를 위해 장치를 보내십시오(수리, 페이지 297 참조).
낮아진 배터리 용량	배터리 결함	배터리를 교환하십시오(배터리 연결, 페이지 283 참조).
장치가 작동하지 않음	내부 오류 (리셋 실행)	배터리 플러그를 풀고 피펫팅 버튼을 10초 동안 누르고 계십시오. 그 다음 배터리 플러그를 다시 단단히 끼우십 시오(배터리 연결, 페이지 283 및 피 펫팅, 페이지 289 참조).

상기 장애 표를 사용해 문제를 해결할 수 없는 경우 공식 딜러 또는 제조
사에 직접 문의하십시오.

8 기술 데이터

기술 데이터	값
충전 소켓	5 VDC
전원장치	입력: 100 – 240 VAC, 50/60 Hz 출력: 5 VDC
배터리	NiMH 배터리 팩 2,4 V, 730 mAh 충전 시간: 4시간 최대 작동 시간: 약 8시간 충전 온도: +10°C ~ +35°C

8.1 제품 표시

기호 또는 번호	의미
XXZXXXXX	일련 번호
QR 코드	시리얼 번호 포함
	이 기호로 당사는 본 제품이 EC 가이드라인에 규정된 요건을 충족하고 규정된 검사 절차를 거쳤음을 확인합니다.
	UKCA: United Kingdom Conformity Assessed 이 기호로 당사는 본 제품이 UK Designated Standards에 규정된 요건을 충족함을 확인합니다.
www.brand.de/ip	특허 정보
 (여기서는: 40년)	중국 RoHS (EFUP) EFUP은 전기 또는 전자 장치에 포함된 위험 물질이 정상적인 작동 조건에서 배출되거나 변경되지 않는 기간을 년수로 정의합니다. 사용자가 정상적으로 사용하는 경우 이러한 전기 또는 전자 제품은 심각한 환경 오염이나 심각한 신체 손상, 사용자의 대문 손상을 유발하지 않습니다.
	전기 장치는 가정용 폐기물과 함께 버리지 마십시오.

9 수리

9.1 수리를 위해 보내기

주의

허가 없이 위험 물질을 수송하는 것은 법으로 금지되어 있습니다.

장치를 철저히 세척하고 오염을 제거하십시오!

- 제품을 반송할 때는 장애 종류 및 사용되었던 매체에 대한 정확한 설명을 첨부하여 주십시오. 사용되었던 매체에 대한 정보를 기재하지 않으면 장치를 수리할 수 없습니다.
- 장치는 배터리 또는 축전지가 없는 상태로만 보내주십시오.
- 반송 시 발생할 수 있는 위험과 비용은 발송자가 책임집니다.

USA 및 캐나다 이외의 지역

“건강 안전에 관한 선언”을 작성하고 장치와 함께 제조사 또는 대리점으로 보내십시오. 양식은 대리점 또는 제조사에게 요청하거나 www.brand.de에서 다운로드할 수 있습니다.

USA 및 캐나다 지역

서비스를 위해 장치를 보내기 **전에** 반송에 관한 전제 조건을 BrandTech Scientific, Inc.에 문의하십시오.

반송 번호와 함께 제공된 주소로 세척되고 오염이 제거된 장치만 보내주십시오. 반송 번호는 포장 외부에 잘 보이도록 부착하십시오.

연락처

독일:

BRAND GMBH + CO KG
Otto-Schott-Straße 25
97877 Wertheim (Germany)
전화 +49 9342 808 0
팩스 +49 9342 808 98000
info@brand.de
www.brand.de

미국 및 캐나다:

BrandTech® Scientific, Inc.
11 Bokum Road
Essex, CT 06426-1506 (USA)
전화 +1 -860 -767 2562
팩스 +1-860-767 2563
info@brandtech.com
www.brandtech.com

인도:

BRAND Scientific Equipment Pvt. Ltd.
303, 3rd Floor, 'C' Wing, Delphi
Hiranandani Business Park,
Powai
Mumbai-400 076 (India)
전화 +91 22 42957790
팩스 +91 22 42957791
info@brand.co.in
www.brand.co.in

중국:

BRAND (Shanghai) Trading Co., Ltd.
Guangqi Culture Plaza
Room 506, Building B
No. 2899, Xietu Road
Shanghai 200030 (P.R. China)
전화 +86 21 6422 2318
팩스 +86 21 6422 2268
info@brand.com.cn
www.brand.cn.com

10 주문 정보

10.1 장치

하우징 상부 색상	주문 번호 (범용 전원장치 및 국가별 어 댑터 포함)	주문 번호 (범용 전원장치 및 국가별 어 댑터 미포함)
흑연색	26350	26360
베리	26351	26361
광유	26352	26362
애머시스트	26353	26363

공급 범위(참조) 전원장치 포함 또는 미포함 주문 번호에 유의하십시오.

10.2 예비 부품

예비 다이어프램 필터

내용	포장 유닛	주문 번호
0.2 μm , 멸균(적색 색상 코드)	1개, 블리스터 포장	26530
0.2 μm	10개, PE 백	26535
3 μm	1개, 블리스터 포장	26052
3 μm	10개, PE 백	26056

전원장치

전원장치 관련 기술 데이터(기술 데이터, 페이지 296 참조)

유형	주문 번호
국가별 어댑터 포함 전원장치	26606

배터리팩

배터리 관련 기술 데이터(기술 데이터, 페이지 296 참조)

내용	주문 번호
NiMH 배터리팩	26630

체크 밸브 포함 실리콘 어댑터

내용	주문 번호
실리콘 어댑터	26508

어댑터 하우징

색상	주문 번호
화이트	26658

벽 브래킷

색상	주문 번호
화이트	26539

접착 테이프

포장 유닛	주문 번호
3세트	26547

11 결함에 대한 책임

당사는 장치의 부적절한 취급이나 사용, 유지보수, 작동, 무단 수리의 결과 또는 피스톤, 실링, 밸브 등과 같은 마모 부품의 일반적인 마모와 유리 파손의 결과에 대해서는 책임을 지지 않습니다. 사용 설명서를 준수하지 않은 경우에도 동일하게 적용됩니다. 특히 당사는 장치를 사용 설명서에 설명된 것보다 더 많이 분해하거나 타사 부품 또는 예비 부품이 장착된 경우 발생한 손상에 대해 책임을 지지 않습니다.

미국 및 캐나다:

결함에 대한 책임 관련 정보는 www.brandtech.com을 참조하십시오.

12 폐기



옆의 기호는 배터리/축전지 및 전자 장치를 수명 경과 후 가정용 폐기물(분류되지 않은 주거용 쓰레기)에서 분리하여 폐기해야 함을 나타냅니다.

전자 장치는 노후한 전기 및 전자 장치에 관한 2012년 7월 4일자 유럽 의회 및 이사회 가이드라인 2012/19/EU에 따라 국가의 폐기물 규정에 따라 전문적으로 폐기해야 합니다.

배터리와 축전지에는 환경과 인간의 건강에 유해할 수 있는 물질이 포함되어 있습니다. 따라서 이들은 배터리 및 축전지에 관한 2006년 9월 6일자 유럽 의회 및 이사회 가이드라인 2006/66/EU에 따라 국가의 폐기물 규정에 따라 전문적으로 폐기해야 합니다. 완전히 방전된 배터리 및 축전지만 폐기하십시오.

EU-Konformitätserklärung | EU Declaration of Conformity

Produktbezeichnung: Product name:	Pipettierhelfer accu-jet® S / Pipetting controller accu-jet® S
Produktvarianten: Product variations:	Anthrazit, Beere, Petrol, Amethyst / anthracite, berry, petrol, amethyst
Art-Nr. / Cat.-No.	26350, 26351, 26352, 26353, 26360, 26361, 26362, 26363

Das oben beschriebene Produkt entspricht den grundlegenden Anforderungen, die in den nachfolgend bezeichneten Harmonisierungsrechtsvorschriften festgelegt sind: The product described above meets the basic requirements that are specified in the harmonization legislation listed below:	Angewendete harmonisierte Normen: Applied harmonized standards:
RoHS: 2011/65/EU incl.2015/863/EU EMC: 2014/30/EU	EN IEC 63000:2018 EN 61326-1:2013
Weitere angewendete Normen: Other applied standards:	Geltungsbereich: Scope:
EN 61010-1:2010, EN 61010-1:2010/A1:2019/AC:2019-04 EN/IEC 62368-1:2014 (angewendet auf Fremdherstellernetzteil / applied to third-party power supply)	NRL / LVD NRL / LVD

Die alleinige Verantwortung für die Ausstellung dieser Konformitätserklärung in Bezug auf die Erfüllung der grundlegenden Anforderungen und die Anfertigung der technischen Unterlagen trägt der Hersteller.

The manufacturer is solely responsible for issuing this declaration of conformity with regard to meeting the essential requirements and preparing the technical documentation.

Hersteller / Manufacturer	Adresse / Address
BRAND GMBH + CO KG	Otto-Schott-Str. 25 97877 Wertheim Germany

Wertheim, 01. Juli 2022 / 01 July 2022



Patrick Ziemeck
Managing Director Technology



i.A. Siegfried Ott
Regulatory Affairs

Diese Erklärung bescheinigt die Übereinstimmung mit den genannten Harmonisierungsvorschriften, beinhaltet jedoch keine Zusicherung von Eigenschaften.

This document declares the accordance with the named harmonized regulations, but does not assure specific properties.

UK Declaration of Conformity

Product name: Pipetting controller accu-jet® S
Product variations: anthracite, berry, petrol, amethyst
Cat.-No. 26350, 26351, 26352, 26353, 26360, 26361, 26362, 26363

The product described above meets the basic requirements that are specified in the harmonization legislation listed below:	Applied harmonized standards:
The Restriction of the Use of Certain Hazardous Substances in Electrical and Electronic Equipment Regulations 2012 (SI 2012 No. 3032)	EN IEC 63000:2018
Electromagnetic Compatibility Regulations 2016 (SI 2016 No. 1091, as amended by SI 2019 No. 696)	EN 61326-1:2013
Other applied standards:	Scope:
EN 61010-1:2010, EN 61010-1:2010/A1:2019/AC:2019-04 EN/IEC 62368-1:2014 (angewendet auf Fremdherstellernetzteil / applied to third-party power supply)	LVD LVD

The manufacturer is solely responsible for issuing this declaration of conformity with regard to meeting the essential requirements and preparing the technical documentation.

Manufacturer	Address
BRAND GMBH + CO KG	Otto-Schott-Str. 25 97877 Wertheim Germany

Wertheim, 18 February 2022



Patrick Ziemeck
Managing Director Technology



i.A. Siegfried Ott
Regulatory Affairs

This document declares the accordance with the named harmonized regulations, but does not assure specific properties.

Declaration of conformity – China RoHS 2

BRAND GMBH + CO KG has made reasonable efforts to ensure that hazardous materials and substances may not be used in BRAND products.

In order to determine the concentration of hazardous substances in all homogeneous materials of the subassemblies, a “Product Conformity Assessment” (PCA) procedure was performed. As defined in GB/T 26572 the “Maximum Concentration Value” limits (MCV) apply to these restricted substances:

+ Lead (Pb):	0.1%	+ Hexavalent chromium (Cr(+VI)):	0.1%
+ Mercury (Hg):	0.1%	+ Polybrominated biphenyls (PBB):	0.1%
+ Cadmium (Cd):	0.01%	+ Polybrominated diphenyl ether (PBDE):	0.1%

Environmental Friendly Use Period (EFUP)

EFUP defines the period in years during which the hazardous substances contained in electrical and electronic products will not leak or mutate under normal operating conditions. During normal use by the user such electrical and electronic products will not result in serious environmental pollution, cause serious bodily injury or damage to the user's assets.

The Environmental Friendly Use Period for BRAND instruments is 40 years.



Material Content Declaration for BRAND Products

部件名称 Part name	有毒有害物质或元素 Hazardous substances					
	铅 Pb	汞 Hg	镉 Cd	六价铬 Cr(+VI)	多溴联苯 PBB	多溴二苯醚 PBDE
包装 / Packaging	0	0	0	0	0	0
塑料外壳 / 组件 Plastic housing / parts	0	0	0	0	0	0
电池 / Battery	0	0	0	0	0	0
玻璃 / Glass	0	0	0	0	0	0
电子电气组件 Electrical and electronic parts	X	0	0	0	0	0
金属外壳 / 组件 Metal housing / parts	X	0	0	0	0	0
电机 / Motor	X	0	0	0	0	0
配件 / Accessories	X	0	0	0	0	0

此表格是按照SJ/T 11364-2014中规定所制定的。

This table is created according to SJ/T 11364-2014.

- O: 表示该有毒有害物质在该部件所有均质材料中的含量均在GB/T 26572规定的限量要求以下。
- O: Indicates that the above mentioned hazardous substance contained in all homogeneous materials of the part is below the required limit as defined in GB/T 26572.
- X: 表示该有毒有害物质至少在该部件某一均质材料中的含量超出GB/T 26572规定的限量要求。
- X: Indicates that the above mentioned hazardous substance contained in at least one of the homogeneous materials of this part is above the required limit as defined in GB/T 26572.

注释： 电池，玻璃制品和配件可能不属于此设备的一部分且/或可能有它自己的EFUP标志且/或可能包含更改EFUP标志的部件。

Note: Batteries, glassware and accessories might not be content of the enclosed device and/or may have their own EFUP-marking and/or might be maintaining parts with changing EFUP-marking.

除上表所示信息外，还需声明的是，这些部件并非是有用铅 (Pb), 汞 (Hg), 镉 (Cd), 六价铬 (Cr(+VI)), 多溴联苯 (PBB) 或多溴二苯醚 (PBDE) 来制造的。

Apart from the disclosures in the above table, the subassemblies are not intentionally manufactured or formulated with lead (Pb), mercury (Hg), cadmium (Cd), hexavalent chromium (Cr+VI), polybrominated biphenyls (PBB), and polybrominated diphenyl ethers (PBDE).

Products manufactured by BRAND may enter into further devices or can be used together with other appliances. With these third party products and appliances in particular, please note the EFUP labeled on these products. BRAND will not take responsibility for the EFUP of those products and appliances.

Place, date: Wertheim, 05|04|2022



Patrick Ziemeck
(Managing Director Technology)



i.A. Siegfried Ott
(Regulatory Affairs)

Innehållsförteckning

1 Inledning	309
1.1 leveransomfattning.....	309
1.2 Ändamålsenlig användning.....	309
2 Säkerhet	311
2.1 Funktion.....	312
2.2 Användningsgränser	312
2.3 Utesluten användning	312
2.4 Förvaring.....	313
3 Funktions- och manöverelement	314
4 Idrifttagning	316
4.1 Anslut batteriet	316
4.2 Ladda batteriet.....	318
4.3 Starta enheten.....	319
4.4 Välj driftssätt	319
4.5 Sug upp eller töm ut vätska.....	319
4.6 Ändra pipetteringshastighet.....	319
4.7 Ställ in motorvarvtal	320
4.8 Förvaring av enheten	320
5 Pipettering	322
6 Rengöring	324
6.1 Kontrollera täthet	324
6.2 Byt filter och rengör adapter	324
6.3 UV-sterilisering.....	327
7 Störning - vad göra?.....	328
8 Tekniska data.....	329
8.1 Märkning på produkten	329

9	Reparation.....	330
9.1	Skicka in för reparation	330
10	Beställningsinformation	332
10.1	Enhet.....	332
10.2	Reservdelar.....	332
11	Produktdefektansvar.....	334
12	Bortskaffning.....	335

1 Inledning

1.1 leveransomfattning

Pipetteringshjälp, nickel-metallhydrid-batteri, nätdel tillval (OBS olika best.nr), 2 reservmembranfilter 0,2 µm, vägghållare, bruksanvisning

1.2 Ändamålsenlig användning



- Läs bruksanvisningen noggrant före första användning.
- Bruksanvisningen är en del av enheten och måste finnas tillhands lätt tillgänglig.
- Bifoga bruksanvisningen om du lämnar enheten vidare till tredjepart.

1.2.1 Faronivåer

Följande signalord känneteckningar möjliga faror:

Signalord	Betydelse
FARA	Leder till svåra personskador eller dödsfall.
VARNING	Kan leda till svåra personskador eller dödsfall.
SE UPP	Kan leda till lätta eller medelsvåra personskador.
HÄNVISNING	Kan leda till saksador.

1.2.2 Symboler i bruksanvisningen

Symbol	Betydelse	Symbol	Betydelse
	Faroställe		Explosionsrisk

Symbol	Betydelse	Symbol	Betydelse
	Använd ögonskydd		Använd skyddshandskar

1.2.3 Presentation

Presentatio n	Betydelse	Presentatio n	Betydelse
1. Task	Kännetecknar en uppgift.	>	Kännetecknar en förutsättning.
a., b., c.	Kännetecknar olika steg i uppgiften.	⇒	Kännetecknar ett resultat.

2 Säkerhet

Dessa måste ovillkorligen läsas noggrant!

Laboratorieenheten accu-jet® S kan användas i kombination med farliga material, arbetsprocesser och apparater. Bruksanvisningen kan emellertid inte innehålla samtliga säkerhetsproblem som då kan uppträda. Det åligger användaren att säkerställa att säkerhets- och hälsoföreskrifterna efterlevs och att definiera adekvata begränsningar före användningen.

1. Varje användare måste ha läst denna bruksanvisning innan enheten används, samt följa den.
2. Följ allmänna farohänvisningar och säkerhetsföreskrifter, använd t.ex. skyddskläder, ögonskydd och skyddshandskar.
3. Beakta reagenstillverkarnas uppgifter.
4. Använd inte enheten i explosionsfarlig atmosfär och pipettera inga lättantändliga medier.
5. Använd enheten endast för pipettering av vätskor och endast inom ramen för de definierade användningsgränserna. Beakta den uteslutna användningen, se Uteslutna användning, sida 312 ! I tveksamma fall skall tillverkaren eller återförsäljaren ovillkorligen kontaktas.
6. Arbeta alltid så att varken användaren eller andra personer hamnar i fara. Undvik stänk. Använd endast lämpliga kärl.
7. Använd aldrig våld.
8. Använd endast originaltillbehör och -reservdelar. Gör inga tekniska modifieringar. Ta inte isär enheten mer än vad som anges i bruksanvisningen!
9. Före användning måste man alltid kontrollera att enheten är i korrekt skick. Om det uppstår störningar i enheten måste man omedelbart upphöra med pipetteringen och följa kapitlet Störning - vad göra?. Kontakta ev. tillverkaren.
10. För uppladdning av nickel-metallhydrid-batteriet får endast originalnättdelen användas.

11. Batteriet får inte bytas ut mot batterier från andra tillverkare.
12. Nätdelen skall skyddas mot fukt och får användas endast i kombination med denna enhet.
13. Använd inte nätdelen om anslutningsledningen är skadad.
14. Reparationer och ingrepp i enheten får göras endast av auktoriserad servicetekniker.

2.1 Funktion

Enheten är ett hjälpmedel för pipettering av vätskor med mät- och fullpipetter av glas eller plast i volymintervallet från 0,1 ml till 200 ml och med en sugrörsytterdiameter < 9,2 mm. Vid korrekt handhavande kommer den pipetterade vätskan i kontakt endast med pipetten.

2.2 Användningsgränser

Enheten används för pipettering av vätskor med beaktande av följande fysikaliska gränser:

- från +10 °C till +40 °C (från 50 °F till 104 °F) (enhet och reagens)
- Ångtryck till max. 500 mbar. Över 300 mbar skall uppsugning ske långsamt för att undvika att vätskan kokar.
- Täthet upp till 9 g/cm³

2.3 Utesluten användning

Enheten får inte användas till vätskor vilkas ångor har en korroderande verkan resp. angriper materialen silikon eller EPDM.

Enheten är inte lämplig för användning med pastörpipetter.

VARNING



Användning av enheten i explosionsfarlig omgivning

Enheten får inte användas eller laddas i explosionsfarlig omgivning. Inga lättantändliga medier får pipetteras (flampunkt under 0 °C (32 °F) t.ex. eter, aceton).

2.4 Förvaring

Förvara enheten och tillbehöret endast i rengjort skick på en sval och torr plats.

Förvaringstemperatur: från -20 °C till + 50 °C (från -4 °F till 122 °F).

Relativ luftfuktighet: 5 % till 95 %.

3 Funktions- och manöverelement

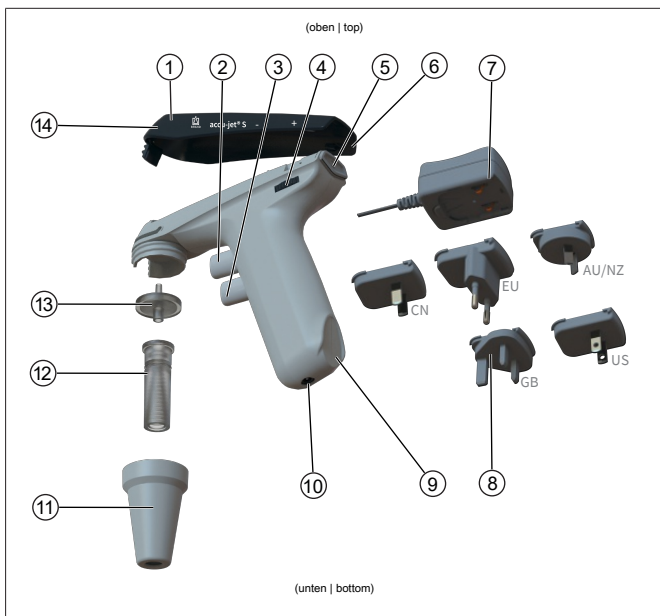

- | | |
|--|---|
| 1 Husovandel | 2 Övre pipetteringsknapp (ta upp vätska) |
| 3 Undre pipetteringsknapp (avge vätska) | 4 Ställhjul för motorvarvtal |
| 5 Väljare för driftsätt | 6 Inställningsyta husovandel |
| 7 Nätdel | 8 Landsadapter |
| 9 Inställningsyta handtag | 10 Ladduttag |
| 11 Adapterhus (PP) | 12 Adapter/backventil (SI/PTFE) |
| 13 Membranfilter (PP/PTFE) | 14 Tryckutjämningsöppning |

Uppgifter om spänning och strömförbrukning, se Tekniska data, sida 329.

Förk.	Material
PP	Polypropylen
PTFE	Polytetrafluoretylen

Förk.	Material
SI	Silikon

4 Idrifttagning

4.1 Anslut batteriet

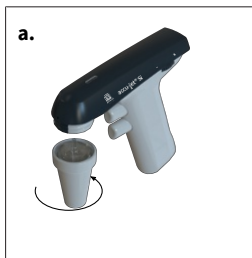

- a.** Skruva av adapterhuset. Adapter och filter är kvar i adapterhuset.

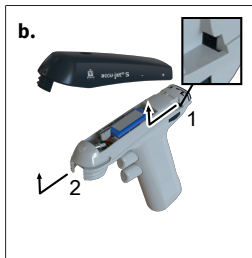

- b.** Ta av huset. Skjut huset lätt i riktning mot adapterhusets förskruvning.
- ⇒ Huset lossnar ur ursparningarna ovanför ställhjulet (1) och ur adapterhusets (2) förskruvning.
- ⇒ Batterifacket syns.

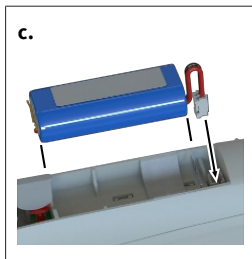

- c.** Håll batteriets kontakt i kabeln, rikta in den och sätt i den ordentligt i bussningen tills att den hakar på plats med ett distinkt ljud. Lägg i batteriet.

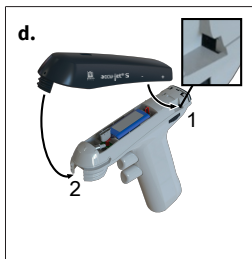

- d.** Sätt i huset. Se till att huset griper in i här för avsedda urtag ovanför ställhjulet (1) och i adapterhusets (2) skruvförband.

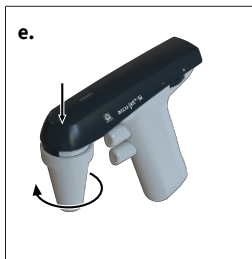

- e.** Tryck in husöverdelen i husskålarna och skruva på adapterhuset.

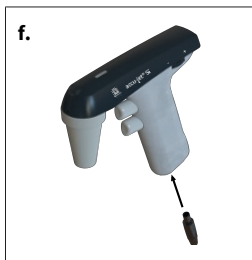

- f.** Ladda batteriet tills att LED-laddindikatorn blinkar grönt. Laddtid ca 4 timmar, se Ladda batteriet.

4.2 Ladda batteriet

⚠ VARNING



Skadad nätdel eller laddkabel

Risk för personskador p.g.a. strömstötar.



> Använd inte en skadad nätdel.

> Om laddkabeln är skadad får nätdelen inte användas.

ANVISNING

Använd endast tillverkarens originalnättdel!

Användning av annan nätdel kan skada enheten och batteriet.

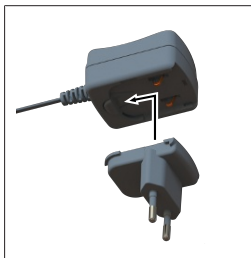

- a. Sätt i landsadaptorn på nätdelen.
 - b. Förbind nätdelen med enheten.
 - c. Sätt i nätdelen i nätkontakten.
- ⇒ Enheten laddas. Det ser man på LED-laddindikatorn på husets ovandel. För drifttid och laddperiod, se Tekniska data, sida 329 .

LED-laddindikator	Status	Vad göra?
Grönt: blinkande	Batteriet är laddat. Underhållsladdning sker.	Du kan arbeta med enheten. Enheten är fulladdad.
Grönt: permanent sken	Batteriet laddas	Du kan fortsätta arbeta under laddningen.
Rött: blinkande	Batteriet är nästan tomt.	Avbryt arbetet med enheten. Ladda upp batteriet. Du kan fortsätta arbeta under laddningen.
Rött: permanent sken	Batteriet är tomt.	Ladda upp batteriet.

- Underhållsladdningen förhindrar överladdning och minimerar lazy-battery-effekten. För upprätthållande av max.kapaciteten: ladda batteriet först när så anges av LED-laddindikatorn.

4.3 Starta enheten

Enheten är redo för drift när ett laddat batteri är isatt. Det finns ingen ON/OFF-knapp.

4.4 Välj driftsätt

Väljare, se Funktions- och manöverelement, sida 314 .

Driftsätt ”Fritt utlopp”: skjut väljaren uppåt.

Driftsätt ”Urblåsning med motorstöd”: skjut väljaren nedåt.

4.5 Sug upp eller töm ut vätska

Pipetteringsknapp, se Funktions- och manöverelement, sida 314

För att fylla pipetten: tryck på den övre pipetteringsknappen; för att tömma den: tryck på den undre pipetteringsknappen.

4.6 Ändra pipetteringshastighet

Hastigheten begränsas av det inställda maximala motorvarvtalet. Ju med den övre eller undre pipetteringsknappen trycks in, desto snabbare sugs vätska upp eller töms.

4.7 Ställ in motorvarvtal

Inställningshjul, se Funktions- och manöverelement, sida 314

Motorvarvtalet kan ställas in steglöst från maximum (+) till minimum (-) med en vridning på inställningshjulet. Vi rekommenderar det maximala motorvarvtalet för storvolymspipetter, och ett lägre motorvarvtal för småvolymspipetter.

4.8 Förvaring av enheten

4.8.1 Bordsplacering

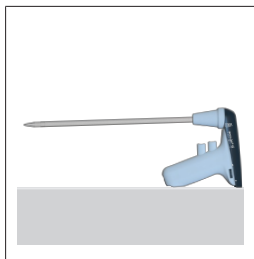

accu-jet® S kan ställas ned på en jämn yta med isatt pipett.

4.8.2 Vägghållare



- a. Rengör fästytan med lämpligt rengöringsmedel (inga återfettande hushållsrengöringsmedel) och luddfri trasa, och låt torka väl.
- b. Dra bort skyddsfolien från tejprensan
- c. Tryck fast vägghållaren **hårt** mot fästytan.

5 Pipettering

1. Sätt på pipetten

⚠ VARNING



Se till att pipetten sitter ordentligt. Använd aldrig våld! I synnerhet vid tunna pipetter råder risk för glasbrott! Risk för personsador!

1.



- a. Håll alltid pipetten så nära som möjligt i övre änden och skjut försiktigt in den i adaptern tills att den fastnar.
- b. Håll alltid enheten med insatt pipett lodrätt, spetsen nedåt.

2. Fyll pipetten

2.

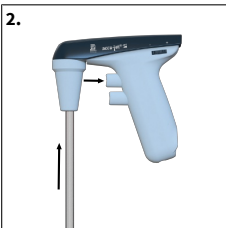

- a. Sätt i pipettspetsen i vätskan.
- b. Tryck långsamt in den övre pipetteringsknappen och fyll pipetten så att menisken ligger något ovanför de önskade märkena.
- c. Om båda pipetteringsknapparna trycks in kan man ta upp eller tömma ut vätska mycket exakt. Det är mycket praktiskt i synnerhet när man ställ in menisken eller använder pipetter med liten volym.

Överfyll inte pipetten.

3. Ställ in volymen

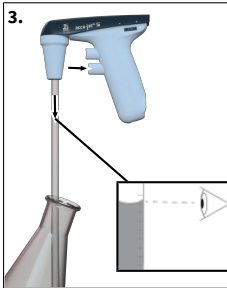

- a. Torka ev. av pipettspetsen med lämplig luddfri trasa.
- b. Tryck långsamt in den undre pipetteringsknappen och töm ut vätska tills att menisken är inställd exakt på det önskade märket.

4. Töm pipetten

- a. Tryck långsamt in den undre pipetteringsknappen. Pipetteringshastigheten är avhängig av hur långt pipetteringsknappen trycks in. I driftsätt ”Urblåsning med motorstöd” är den också avhängig av det inställda motorvarvtalet.

5. Efter pipettering

- a. Fatta tag i pipetten så långt upp som möjligt och dra ut den ur adaptern.

6 Rengöring

ANVISNING

accu-jet® S kan inte autoklaveras

Torka av husdelarna då och då med en fuktad trasa. Vid korrekt användning är enheten underhållsfri.

6.1 Kontrollera täthet

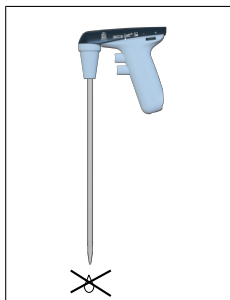

Efter inställning av menisken får det inte droppa ut vätska ur pipetten utan manövrering av ventilerna. Droppar pipetten, se Störning - vad göra?

6.2 Byt filter och rengör adapter

⚠ VARNING



Risk för kontaminering och infektion

Använd skyddshandskar och ögonskydd.



ANVISNING

Filterbyte eller rengöring krävs endast om en pipett har överfyllts eller om sugverkan är försämrad.

b.



- a.** Dra ut pipetten.
- b.** Skruva av adapterhuset.
- c.** Ta av överhuset.

d.



- d.** Tryck ut adapter och membranfilter från den koniskt avsmalnande sidan av adapterhuset.

e.



- e.** Dra av det defekta membranfiltret.

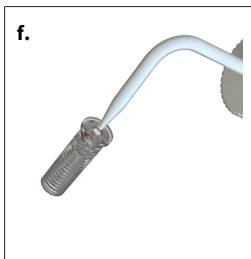

- f.** Rengöring: spola ur adaptern noggrant med en sprayflaska fylld med lämplig rengöringsvätska, t.ex. vatten. Blås sedan ur och torka den.

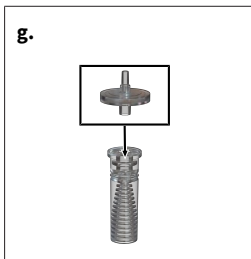

- g.** Tryck in det nya membranfiltret med den tjockare anslutning en nedåt först i adaptern (den tunnare, koniska sidan uppåt) och sätt i det i adapterhuset.

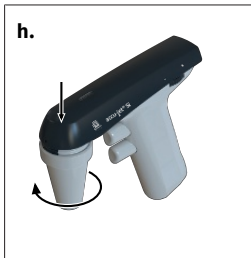

- h.** Tryck in husöverdelen i husskålarna och skruva på adapterhuset.

Hänvisning avs. autoklaverbara filter

Användaren måste själv kontrollera autoklaveringens effekt. Det är inte alla membranfilter som är lämpliga! Använd endast originaltillbehör.

- > Som standard är enheten utrustad med 0,2 µm membranfilter (röd färgkod).
 - > Membranfiltret kan autoklaveras upp till fem gånger vid 121 °C (250 °F).
 - > Med 0,2 µm membranfilter (för cellodling) kan volymtoleranser i klass B uppnås.
 - > För iakttagande av volymtoleranser i klass A krävs 3 µm membranfilter. På grund av den större porvidden har dessa ett lägre inflytande på pipetternas fria avrinningstid, se .
-

6.3 UV-sterilisering

Enheten är beständig mot normal belastning från en UV-steriliseringslampa. En färgförändring kan inträffa p.g.a. UV-effekten.

7 Störning - vad göra?





Störning	Orsak	Vad göra?
Sugverkan försämrad	Motorvarvtalet reducerat	Öka motorvarvtalet, se Ställ in motorvarvtal, sida 320 .
	Backventilen stängd	Ställ väljaren på urlåsning och tryck på den undre pipetteringsknappen, se Välj driftsätt, sida 319
Pipetten droppar	Filtret sitter inte rätt	Sätt i filtret rätt, se Byt filter och rengör adapter, sida 324 .
	Adapter eller pipett skadad	Byt adapter resp. pipett, se Byt filter och rengör adapter, sida 324 .
Pipetten hålls inte i adaptern	Adaptern smutsig eller skadad	Rengör adaptern, lufttorka den, byt ev. ut den, se Byt filter och rengör adapter, sida 324 .
LED-laddindikatorn lyser/blinkar inte efter det att nätdelen har anslutits och spänningsförsörjningen etablerats.	Batterikontakten är inte ordentligt isatt	Sätt i batterikontakten ordentligt, se Anslut batteriet, sida 316 .
	Fel nätdel	Använd endast originalnätdelen, se Funktions- och manöverelement, sida 314
	Batteri resp. nätdel defekt	Byt batteri/nätdel
	Enhet defekt	Skicka in enheten för reparation, se Reparation, sida 330
Låg batterikapacitet	Batteri defekt	Byt ut batteriet, se Anslut batteri, sida 316 .
Enheten visar ingen funktion	Internt fel (gör en reset)	Lossa batterikontakten och håll en pipetteringsknapp intryckt i 10 sek. Sätt i batterikontakten ordentligt igen, se Anslut batteriet, sida 316 och Pipettering, sida 322

Om du inte kan åtgärda problemet med hjälp av störningstabellen kontaktar du din återförsäljare eller tillverkaren direkt.

8 Tekniska data

Tekniska data	Värden
Ladduttag	5 VDC
Nätdel	Ingång: 100 – 240 VAC, 50/60 Hz Utgång: 5 VDC
Batteri	Batteripaket NiMH 2,4 V, 730 mAh Laddtid: 4 h Maximal arbetsperiod: ca 8 h Laddtemperatur: +10 °C till +35 °C

8.1 Märkning på produkten

Referens eller nummer	Betydelse
XXZXXXXX	Serienummer
Quick Response Code	Innehåller serienummer
	Med denna märkning bekräftar vi att produkten uppfyller de krav som fastställs i EU-direktiven och har genomgått de angivna testprocedurerna.
	UKCA: United Kingdom Conformity Assessed Med denna märkning bekräftar vi att produkten uppfyller de krav som fastställs i UK Designated Standards.
www.brand.de	Patentinformation
 (här 40 år)	China RoHS (EFUP) EFUP definierar den tidsrymd uttryckt i år då de farliga ämnen som finns i el- och elektronikenheter inte läcker ut eller ändras vid normala driftsförhållanden. Vid normalt bruk genom användaren leder sådana el- och elektronikprodukter inte till svåra miljöföroreningar, svåra kroppsskador eller skador på användarens sakvärden.
	Den elektriska enheten får inte kastas i hushållssoporna.

9 Reparation

9.1 Skicka in för reparation

ANVISNING

Lagstiftningen förbjuder transport av farliga material utan tillstånd.

Rengör och dekontaminera enheten grundligt!

- I princip skall en noggrann beskrivning av störningstypen och av de använda medierna bifogas retursändningen av produkter. Om uppgift om de använda medierna saknas kan enheten inte repareras.
- Skicka in enheten utan ackumulator resp. batteri.
- Återtransport äger rum på avsändarens risk och bekostnad.

Utanför USA och Kanada

Fyll i ”Förklaring avseende hälsorelaterad säkerhet” och skicka in den tillsammans med enheten till tillverkaren eller återförsäljaren. Förtryckta exemplar kan beställas hos återförsäljaren eller tillverkaren, eller laddas hem från www.brand.de.

Inom USA och Kanada

Rådgör med BrandTech Scientific, Inc. avseende förutsättningarna för retursändningen **innan** du skickar in enheten för service.

Skicka in endast rengjorda och dekontaminerade enheten till den adress som du fick tillsammans med retursändningsnumret. Placera retursändningsnumret väl synligt utvändigt på paketet.

Kontaktadresser

Tyskland:

BRAND GMBH + CO KG
Otto-Schott-Strasse 25
97877 Wertheim (Tyskland)
T +49 9342 808 0
F +49 9342 808 98000
info@brand.de
www.brand.de

USA och Kanada:

BrandTech® Scientific, Inc.
11 Bokum Road
Essex, CT 06426-1506 (USA)
T +1-860-767 2562
F +1-860-767 2563
info@brandtech.com
www.brandtech.com

Indien:

BRAND Scientific Equipment Pvt. Ltd.
303, 3rd Floor, 'C' Wing, Delphi
Hiranandani Business Park,
Powai
Mumbai-400 076 (India)
T +91 22 42957790
F +91 22 42957791
info@brand.co.in
www.brand.co.in

Kina:

BRAND (Shanghai) Trading Co., Ltd.
Guangqi Culture Plaza
Room 506, Building B
No. 2899, Xietu Road
Shanghai 200030 (P.R. China)
T +86 21 6422 2318
F +86 21 6422 2268
info@brand.com.cn
www.brand.cn.com

10 Beställningsinformation

10.1 Enhet

Färg på enhetsöverdelen	Best.nr (med universalnätdel och landsadapter)	Best.nr (utan universalnätdel och utan landsadapter)
Antracit	26350	26360
Bär	26351	26361
Petrol	26352	26362
Ametist	26353	26363

Leveransomfattning, se . Beakta beställningsnumren, med eller utan nätdel.

10.2 Reservdelar

Reservmembranfilter

Beskrivning	Förp.enh.	Best.nr
0,2 µm, steril (röd färgkod)	1 stk i blisterförpackning	26530
0,2 µm	10 stk i PE-påse	26535
3 µm	1 stk i blisterförpackning	26052
3 µm	10 stk i PE-påse	26056

Nätdel

Tekniska data avs. nätdelen, se Tekniska data, sida 329 .

Typ	Best.nr
Nätdel med landsadapter	26606

Batteripaket

Tekniska data avs. batteriet, se Tekniska data, sida 329 .

Beskrivning	Best.nr
Batteripaket NiMH	26630

Silikonadapter med backventil

Beskrivning	Best.nr
Silikonadapter	26508

Adapterhus

Färg	Best.nr
vitt	26658

Vägghållare

Färg	Best.nr
vitt	26539

Häftband

Förp. Enh.	Best.nr
3 set	26547

11 Produktdefektansvar

Vi är inte ansvariga för konsekvenserna av felaktigt handhavande, användning, underhåll, manövrering eller obehörig reparation av enheten eller för konsekvenserna av normalt slitage, i synnerhet av förbrukningsdelar som t.ex. kolvar, tätningar, ventiler samt glasbrott. Det gäller även för ignorering av bruksanvisningen. Vi ikläder oss uttryckligen inget ansvar för uppkomna skador om enheten har tagits isär mer än vad som beskrivs i bruksanvisningen eller om främmande tillbehör resp. reservdelar har monterats.

USA och Kanada:

Information om produktdefektansvar återfinns på www.brandtech.com.

12 Bortskaffning



Invidstående symbol betyder att uttjänta batterier/ackumulatörer och elektroniska enheter måste bortskaffas separat från hushållsavfallet (osorterade hushållssopor).

Elektroniska enheten måste enligt direktiv 2012/19/EU från Europaparlamentet och rådet av 4 juli 2012 avseende uttjänta el- och elektronikenheter bortskaffas korrekt enligt nationella avfallsföreskrifter.

Batterier och ackumulatörer innehåller ämnen som kan ha skadlig effekt på miljön och människors hälsa. De skall därför bortskaffas korrekt enligt direktiv 2006/66/EG från Europaparlamentet och rådet av 6 september 2006 avseende batterier och ackumulatörer enligt nationella avfallsföreskrifter. Bortskaffa endast helt urladdade batterier och ackumulatörer.

EU-Konformitätserklärung | EU Declaration of Conformity

Produktbezeichnung: Product name:	Pipettierhelfer accu-jet® S / Pipetting controller accu-jet® S
Produktvarianten: Product variations:	Anthrazit, Beere, Petrol, Amethyst / anthracite, berry, petrol, amethyst
Art.-Nr. / Cat.-No.	26350, 26351, 26352, 26353, 26360, 26361, 26362, 26363

Das oben beschriebene Produkt entspricht den grundlegenden Anforderungen, die in den nachfolgend bezeichneten Harmonisierungsrechtsvorschriften festgelegt sind: The product described above meets the basic requirements that are specified in the harmonization legislation listed below:	Angewendete harmonisierte Normen: Applied harmonized standards:
RoHS: 2011/65/EU incl.2015/863/EU EMC: 2014/30/EU	EN IEC 63000:2018 EN 61326-1:2013
Weitere angewendete Normen: Other applied standards:	Geltungsbereich: Scope:
EN 61010-1:2010, EN 61010-1:2010/A1:2019/AC:2019-04 EN/IEC 62368-1:2014 (angewendet auf Fremdherstellernetzteil / applied to third-party power supply)	NRL / LVD NRL / LVD

Die alleinige Verantwortung für die Ausstellung dieser Konformitätserklärung in Bezug auf die Erfüllung der grundlegenden Anforderungen und die Anfertigung der technischen Unterlagen trägt der Hersteller.

The manufacturer is solely responsible for issuing this declaration of conformity with regard to meeting the essential requirements and preparing the technical documentation.

Hersteller / Manufacturer	Adresse / Address
BRAND GMBH + CO KG	Otto-Schott-Str. 25 97877 Wertheim Germany

Wertheim, 01. Juli 2022 / 01 July 2022



Patrick Ziemeck
Managing Director Technology



i.A. Siegfried Ott
Regulatory Affairs

Diese Erklärung bescheinigt die Übereinstimmung mit den genannten Harmonisierungsvorschriften, beinhaltet jedoch keine Zusicherung von Eigenschaften.

This document declares the accordance with the named harmonized regulations, but does not assure specific properties.

UK Declaration of Conformity

Product name: Pipetting controller accu-jet® S
Product variations: anthracite, berry, petrol, amethyst
Cat.-No. 26350, 26351, 26352, 26353, 26360, 26361, 26362, 26363

The product described above meets the basic requirements that are specified in the harmonization legislation listed below:	Applied harmonized standards:
The Restriction of the Use of Certain Hazardous Substances in Electrical and Electronic Equipment Regulations 2012 (SI 2012 No. 3032)	EN IEC 63000:2018
Electromagnetic Compatibility Regulations 2016 (SI 2016 No. 1091, as amended by SI 2019 No. 696)	EN 61326-1:2013
Other applied standards:	Scope:
EN 61010-1:2010, EN 61010-1:2010/A1:2019/AC:2019-04 EN/IEC 62368-1:2014 (angewendet auf Fremdherstellernetzteil / applied to third-party power supply)	LVD LVD

The manufacturer is solely responsible for issuing this declaration of conformity with regard to meeting the essential requirements and preparing the technical documentation.

Manufacturer	Address
BRAND GMBH + CO KG	Otto-Schott-Str. 25 97877 Wertheim Germany

Wertheim, 18 February 2022



Patrick Ziemeck
Managing Director Technology



i.A. Siegfried Ott
Regulatory Affairs

This document declares the accordance with the named harmonized regulations, but does not assure specific properties.

Declaration of conformity – China RoHS 2

BRAND GMBH + CO KG has made reasonable efforts to ensure that hazardous materials and substances may not be used in BRAND products.

In order to determine the concentration of hazardous substances in all homogeneous materials of the subassemblies, a “Product Conformity Assessment” (PCA) procedure was performed. As defined in GB/T 26572 the “Maximum Concentration Value” limits (MCV) apply to these restricted substances:

+ Lead (Pb):	0.1%	+ Hexavalent chromium (Cr(+VI)):	0.1%
+ Mercury (Hg):	0.1%	+ Polybrominated biphenyls (PBB):	0.1%
+ Cadmium (Cd):	0.01%	+ Polybrominated diphenyl ether (PBDE):	0.1%

Environmental Friendly Use Period (EFUP)

EFUP defines the period in years during which the hazardous substances contained in electrical and electronic products will not leak or mutate under normal operating conditions. During normal use by the user such electrical and electronic products will not result in serious environmental pollution, cause serious bodily injury or damage to the user's assets.

The Environmental Friendly Use Period for BRAND instruments is 40 years.



Material Content Declaration for BRAND Products

部件名称 Part name	有毒有害物质或元素 Hazardous substances					
	铅 Pb	汞 Hg	镉 Cd	六价铬 Cr(+VI)	多溴联苯 PBB	多溴二苯醚 PBDE
包装 / Packaging	0	0	0	0	0	0
塑料外壳 / 组件 Plastic housing / parts	0	0	0	0	0	0
电池 / Battery	0	0	0	0	0	0
玻璃 / Glass	0	0	0	0	0	0
电子电气组件 Electrical and electronic parts	X	0	0	0	0	0
金属外壳 / 组件 Metal housing / parts	X	0	0	0	0	0
电机 / Motor	X	0	0	0	0	0
配件 / Accessories	X	0	0	0	0	0

此表格是按照SJ/T 11364-2014中规定所制定的。

This table is created according to SJ/T 11364-2014.

- O: 表示该有毒有害物质在该部件所有均质材料中的含量均在GB/T 26572规定的限量要求以下。
O: Indicates that the above mentioned hazardous substance contained in all homogeneous materials of the part is below the required limit as defined in GB/T 26572.
- X: 表示该有毒有害物质至少在该部件某一均质材料中的含量超出GB/T 26572规定的限量要求。
X: Indicates that the above mentioned hazardous substance contained in at least one of the homogeneous materials of this part is above the required limit as defined in GB/T 26572.

注释： 电池，玻璃制品和配件可能不属于此设备的一部分且/或可能有它自己的EFUP标志且/或可能包含更改EFUP标志的部件。

Note: Batteries, glassware and accessories might not be content of the enclosed device and/or may have their own EFUP-marking and/or might be maintaining parts with changing EFUP-marking.

除上表所示信息外，还需声明的是，这些部件并非是有用铅 (Pb), 汞 (Hg), 镉 (Cd), 六价铬 (Cr(+VI)), 多溴联苯 (PBB) 或多溴二苯醚 (PBDE) 来制造的。

Apart from the disclosures in the above table, the subassemblies are not intentionally manufactured or formulated with lead (Pb), mercury (Hg), cadmium (Cd), hexavalent chromium (Cr+VI), polybrominated biphenyls (PBB), and polybrominated diphenyl ethers (PBDE).

Products manufactured by BRAND may enter into further devices or can be used together with other appliances. With these third party products and appliances in particular, please note the EFUP labeled on these products. BRAND will not take responsibility for the EFUP of those products and appliances.

Place, date: Wertheim, 05|04|2022



Patrick Ziemeck
(Managing Director Technology)



i.A. Siegfried Ott
(Regulatory Affairs)

目次

1	はじめに	342
1.1	供給範囲	342
1.2	使用規則	342
2	安全	344
2.1	機能.....	345
2.2	使用制限	345
2.3	用途の除外.....	346
2.4	保管条件	346
3	機能要素と操作要素	347
4	運転開始	349
4.1	バッテリーの接続.....	349
4.2	バッテリーの充電	351
4.3	装置の始動.....	352
4.4	運転モードの選択	352
4.5	液体の吸取りまたは引渡し.....	353
4.6	ピペッティング速度の変更.....	353
4.7	モーター回転数の設定	353
4.8	装置の保管.....	354
5	ピペッティング	355
6	クリーニング	358
6.1	密閉性の検査	358
6.2	フィルターの交換とアダプターのクリーニング	359
6.3	UV殺菌.....	362
7	故障—何を行なうか？	363

8	技術データ	365
8.1	製品の標識	365
9	修理	367
9.1	修理のための送付	367
10	注文情報	369
10.1	装置	369
10.2	スペアパーツ	369
11	保証	372
12	ゴミ処理	373

1 はじめに

1.1 供給範囲

ピペットコントローラー、ニッケル水素電池、オプションの電源アダプター（注文番号が異なるので注意してください）、二個のスペア膜フィルター0.2 μm、ウォールホルダー、取扱説明書

1.2 使用規則

- 取扱説明書を最初にご使用になる前によくお読みください。
- 取扱説明書は装置の一部であり、すぐに手の届くところに保管しておいてください。
- 本装置を第三者に渡す場合には、取扱説明書も一緒にお渡しください。

1.2.1 危険レベル

次のシグナルワードは、危険の可能性を表しています：

シグナルワード	意味
危険	重傷または死亡に至ります。
警告	重傷または死亡に至ることがあります。
注意	軽傷または中程度の怪我に至ることがあります。
指示	物的損害に至ることがあります。

1.2.2 取扱説明書のシンボル

シンボル	意味	シンボル	意味
	危険な箇所		爆発の危険
	ゴーグルの着用		保護手袋の着用

1.2.3 表示

表示	意味	表示	意味
1.タスク	課題を表しています。	>	前提条件を表しています。
a., b., c.	課題の個々のステップを表しています。	⇒	結果を表しています。

2 安全

必ず注意して読み通してください！

実験装置 accu-jet® S は、危険な素材、作業プロセスおよび器具と組み合わせて使用することができます。但し、取扱説明書が、その際の場合によっては発生する可能性のある全ての安全上の問題を網羅できるわけではありません。安全衛生上の規則の遵守を保証して、使用前に適切な制限を講じるのはユーザーの責任です。

1. 各ユーザーは、装置を使用する前に取扱説明書を読んでおきこれに注意を払ってください。
2. 防護服、目の防護、保護手袋の着用などの危険に関する全般的な指示と安全上の規則に従ってください。
3. 試薬メーカーの記載事項に注意を払ってください。
4. 爆発の危険のある空気の中で装置を使用しないでください。発火しやすい媒体はピペティングしないでください。
5. 液体をピペティングするためにもみおよび定められた用途の範囲内でのみ装置を使用してください。用途の除外に注意を払ってください、用途の除外, p. 346 を参照！疑問点がある場合には、必ずメーカーか販売店にご連絡ください。
6. 常にユーザーにも他の人も危険に晒さないように作業をしてください。飛沫を飛ばさないようにしてください。適切な容器のみをご使用ください。
7. 力づくでやらないでください。
8. 純正アクセサリと純正パーツのみをご使用ください。機械的な改造を加えないでください。取扱説明書に記載されている以上に装置を分解しないでください。

9. 使用前に必ず装置が適切な状態であるかどうかをチェックしてください。装置の故障が通知された場合には、直ちにピペッティングを中断して、Störung - Was tun? に従ってください。必要に応じてメーカーに連絡してください。
10. ニッケル水素電池を充電する場合には必ず純正の電源アダプターをご使用ください。
11. バッテリーは、他社のメーカーのバッテリーと交換しないでください。
12. 電源アダプターは湿気から守り、使用する場合には必ず本装置と接続してください。
13. 接続ケーブルが損傷している場合には、電源アダプターをご使用にならないでください。
14. 装置を修理したり手を加えるのができるのは、認可された整備技術者に限られます。

2.1 機能

本装置は、0.1 mlから200 mlの容積範囲で、外径が<9.2 mmの吸入管で、ガラス製またはプラスチック製の目盛りのあるピペットと体積測定ピペットを用いて液体をピペッティングする際の補助として用いられます。装置を正しく操作すると、ピペッティングされる液体がピペットだけに接触します。

2.2 使用制限

本装置は、以下の物理的な特性に注意して液体をピペッティングするのに用います。

- +10 °Cから+40 °C (50 °F から 104 °F) (装置と試薬)
- 最大で500 mbarの蒸気圧力。300 mbarを超えると液体が沸騰しないようにゆっくりと吸い取ります。
- 9 g/cm³までの密度

2.3 用途の除外

本装置では、蒸気が腐食作用を持つか、シリコンやEPDMの素材を攻撃する液体を使用しないでください。

本装置は、パスツールピペットを用いた使用には適していません。

⚠ 警告



爆発の危険のある環境での装置の操作

本装置を爆発の危険のある環境で操作または充電しないでください。発火性のある媒体 (0 °C (32 °F)未満の引火点、エーテルやアセトンなど)。

2.4 保管条件

装置とアクセサリは必ずきれいな状態で冷たくて乾燥した場所で保管します。

保管温度： -20 °C から +50 °C (-4 °F から 122 °F)。

相対湿度： 5 % から 95 %。

3 機能要素と操作要素

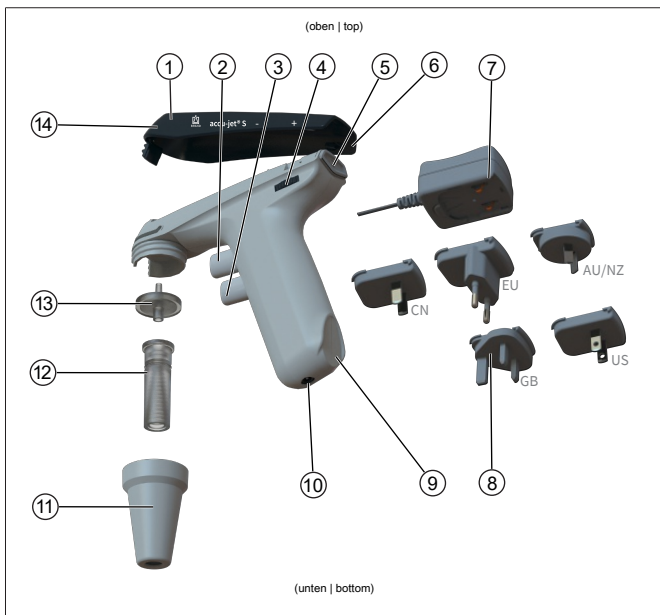

- | | |
|---------------------|------------------------|
| 1 容器の上のシェル | 2 上のピペットボタン（液体の受取り） |
| 3 下のピペットボタン（液体の引渡し） | 4 モーター回転数調整ホイール |
| 5 運転モード選択スイッチ | 6 設置場所 容器の上のシェル |
| 7 電源アダプター | 8 国別のアダプター |
| 9 設置場所 グリップ | 10 充電ソケット |
| 11 アダプター-容器 (PP) | 12 アダプター/逆止弁 (SI/PTFE) |
| 13 膜フィルター (PP/PTFE) | 14 圧力調整開口 |

電圧と消費電力の記載事項については、技術データ, p. 365 をご覧ください。

3 機能要素と操作要素

略語	素材
PP	ポリプロピレン
PTFE	ポリテトラフルオロエチレン
SI	シリコン

4 運転開始

4.1 バッテリーの接続

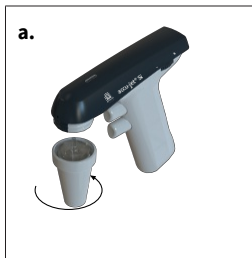

- a. アダプター容器をねじって外します。アダプターとフィルターはアダプター容器に入ったままです。

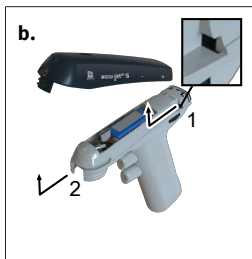

- b. 容器を外します。アダプター容器のネジ方向にケースを少し押しします。

⇒ ケースは調整ホイール(1)の上にあるスロットとアダプター容器(2)のネジから外れます。

⇒ バッテリーコンパートメントが見えるようになります。

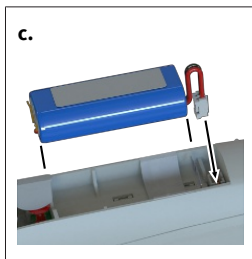

- c. バッテリープラグのケーブルを持ち、適切な方向に向け、ソケットにカチッと音が聞こえるまでしっかりと差し込みます。バッテリーをはめ込みます。

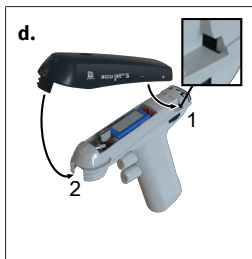

- d. ケースをはめ込みます。その際に、容器をまず調整ホイール(1)の上にあるスロットに、次にアダプター容器(2)のネジにかみ合わせるようにしてください。

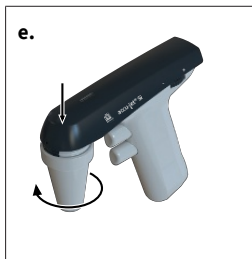

- e. 容器の上の部分を容器のシェルに押し込み、アダプター容器をねじ込みます。

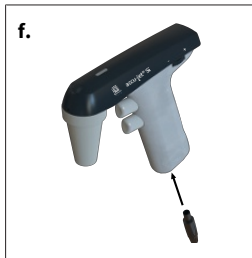

- f. LED充電表示器が緑色に点滅するまでバッテリーを充電します。充電時間は約4時間です、バッテリーの充電を参照。

4.2 バッテリーの充電

▲ 警告



**損傷した電源アダプターまたは充電ケーブル
感電による怪我の危険**



- > 損傷した電源アダプターをご使用にならないでください。
- > 充電ケーブルが損傷している場合には、電源アダプターをご使用にならないでください。

注記

メーカーの純正の電源アダプターのみをご使用ください。

それ以外の電源アダプターを使用すると、装置やバッテリーが損傷する場合があります。

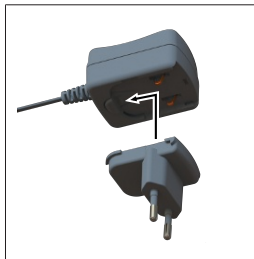

- a. 国別のアダプターを電源アダプターに差し込みます。
 - b. 電源アダプターを装置に接続します。
 - c. 電源アダプターを電源プラグに差し込みます。
- ⇒ 装置が充電されます。充電状態は、容器の上の部分にあるLED充電表示器に表示されます。運転時間と充電時間については、技術データ, p. 365 を参照。

LED充電表示器	ステータス	何を行なうか？
緑色： 点滅	バッテリーが充電されました。維持充電が行われます。	装置を使って作業ができません。装置は完全に充電されています。

LED充電表示器	ステータス	何を行なうか？
緑色： 常時点灯	バッテリーを充電しています	充電中も作業を継続できます。
赤色： 点滅	バッテリーがほとんど空です。	装置を使った作業を中止します。 バッテリーを充電します。 充電中も作業を継続できます。
赤色： 常時点灯	バッテリーが空です。	バッテリーを充電します。

注記

- > 維持充電は、過剰充電を避け、レイジー・バッテリー効果を最小限に抑えます。最大容量を維持するには、LED充電表示器が表示してからバッテリーを充電します。

4.3 装置の始動

装置は、充電されているバッテリーが使用されていると運転の準備ができています。オン/オフスイッチはありません。

4.4 運転モードの選択

選択スイッチ、機能要素と操作要素、p. 347を参照。

「自由流出」の運転モード：選択スイッチを上に出します。

「モーター支援された吹き出し」の運転モード：選択スイッチを下に出します。

4.5 液体の吸取りまたは引渡し

ピペットボタンについては、機能要素と操作要素, p. 347 を参照

ピペットを充填するには上のピペットボタンを、引渡しをするには下のピペットボタンを押します。

4.6 ピペッティング速度の変更

速度は、設定されている最大のモーター回転数によって制限されています。上または下のピペットボタンを長く押せばそれだけ速く液体が受け取られるか引き渡されます。

4.7 モーター回転数の設定

調整ホイールについては、機能要素と操作要素, p. 347 を参照

モーター回転数は、無段階で最大(+)から最小(-)まで調整ホイールを回すことによって設定できます。当社は、容量の大きなピペットに最大のモーター回転数を、容量の小さなピペットにそれよりも小さいモーター回転数を推奨しています。

4.8 装置の保管

4.8.1 テーブル保管

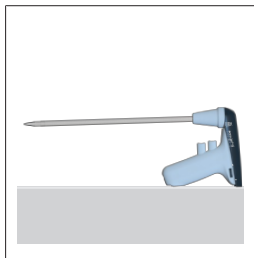

accu-jet® S は、平坦な平面の上にピペットを差し込んだまま置くことができます。

4.8.2 ウォールホルダー



- a. 固定面を（加脂剤の家庭用洗剤ではない）適切な洗剤を使用して毛玉のない布できれいにし、よく乾かします。
- b. 保護フィルムを接着ストライプからはがします
- c. ウォールホルダーを固定面に**しっかりと**押し付けます。

5 ピペティング

1. ピペットの差し込み

⚠ 警告



ピペットがしっかりと差し込まれていることに注意します。無理にやらないでください！特にピペットが薄い場合には、ガラスが壊れる恐れがあります！怪我の危険！

1.



- a. ピペットは常に上端をできるだけ密に保ち、ピペットがしっかりと差し込まれるまでアダプターに押し込みます。
- b. ピペットが差し込まれた装置を常に垂直に保って、先端を下に向けます。

2. ピペットの充填

2.

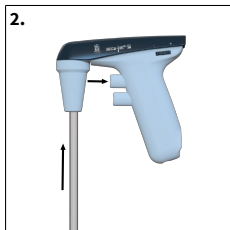

- a. ピペットの先端を液体の中に浸します。
- b. 上のピペットボタンをゆっくりと押し、メニスカスが希望のマークの少し上に来るようにピペットを充填します。
- c. 両方のピペットボタンを押すと、液体を非常に正確に受け取るか引き渡すことができます。これは、

特にメニスカスを調整する場合や容量の小さいピペットを使用する場合に有効になります。

注記

ピペットを過度に充填しないでください。

3.容積の設定

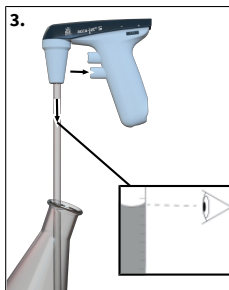

3.
 - a. ピペットの先端を必要に応じてケバのない適切な布で拭ってください。
 - b. 下のピペットボタンをゆっくりと押して、メニスカスがちょうど希望のマークになるまで液体を排出します。

4.ピペットを空にします

- a. 下のピペットボタンをゆっくりと押します。ピペットの速度は、ピペットボタンをどの程度強く押すのかによって変わります。
「モーター支援された吹き出し」の運転モードでは、ピペットの速度はモーター回転数によっても変わります。

5.ピペティング後

- a. ピペットをできるだけ上でつかんで、アダプターから引き抜きます。

6 クリーニング

注記

accu-jet® S は、オートクレーブ処理ができません。

容器の部分は時々湿った布で拭ってください。適正に使用する場合には、本装置はメンテナンスが不要です。

6.1 密閉性の検査

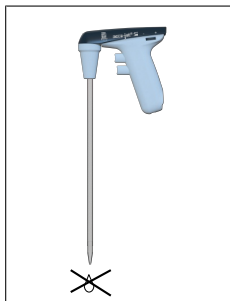

メニスカスを調整した後でバルブを作動させないままで液体がピペットから滴下することがあってはなりません。ピペットからの滴下については、故障一何を行なうか？を参照

6.2 フィルターの交換とアダプターのクリーニング

▲ 警告



汚れと感染の危険

保護手袋と保護眼鏡を着用します。



注記

ピペットが過剰に充填されるか吸取り能力が損なわれた場合に限りフィルターの交換かクリーニングが必要となります。

b.



- a. ピペットを引き抜きます。
- b. アダプター容器をねじって外します。
- c. 上の容器を取り外します。

d.



d. アダプターと膜フィルターをアダプター容器の円錐形になっている側から押し出します。

e.



e. 欠陥のある膜フィルターを引き出します。

f.



f. アダプターをクリーニングするのに、水などの適切な洗浄液で満たされているスプレーボトルを使用して念入りにすすぎます。次に、吹き出して乾かします。

g.

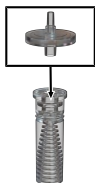

- g.** 新しい膜フィルターを、厚い方の接続部を下に向けてまずアダプターに押し込み（薄い円錐形の側が上に来る）、アダプター容器にはめ込みます。

h.



- h.** 容器の上の部分を容器のシェルに押し込み、アダプター容器をねじ込みます。

注記

オートクレーブ処理のできるフィルターについての指示

オートクレーブ処理の有効性はユーザー自身がその都度確認します。全ての膜フィルターがオートクレーブに適しているとは限りません！純正アクセサリのみをご使用ください。

- > このシリーズでは本装置は0.2 μm の膜フィルター（赤いカラーコード）が装備されています。
 - > 膜フィルターは、121 $^{\circ}\text{C}$ (250 $^{\circ}\text{F}$) で最大で5回までオートクレーブ処理できます。
 - > （細胞培養用の）0.2 μm の膜フィルターでクラスBの容量公差が達成できます。
 - > クラスAの容量公差を遵守するには、3 μm の膜フィルターが必要となります。膜フィルターは、穴の幅が大きくなるために、ピペットの自由な流出時間に対する影響が小さくなります、を参照。
-

6.3 UV殺菌

本装置は、UV殺菌ランプによる通常の負荷に耐えることができます。UV効果によって変色する可能性があります。

7 故障 - 何を行なうか？

故障	原因	何を行なうか？
吸取り能力が 損なわれました	モーター回転数が減少しまし た	モーター回転数を高めます、モ ーター回転数の設定, p. 353 を参照。
	逆止弁が 閉まっています	選択スイッチを吹き出しの位置にし て、下のピペットボタンを押しま す、運転モードの選択, p. 352 を参 照
ピペットからの滴下	フィルターが正しく収まって いません	フィルターを正しくはめ込みます、 フィルターの交換とアダプターのク リーニング, p. 359 を参照。
	アダプターまたはピペットが 損傷しています	アダプターもしくはピペットを交換 します、フィルターの交換とアダ プターのクリーニング, p. 359 を参 照。
ピペットがアダプター に保持されていません	アダプターが汚れているか損 傷しています	アダプターをクリーニングして、空 気乾燥し、必要に応じて交換しま す、フィルターの交換とアダプ ターのクリーニング, p. 359 を参 照。
電源アダプターを接続 し電圧供給が確立した 後で、LED充電表示器 が点灯/点滅しませ ん。	バッテリープラグがしっかりと 差し込まれていません	バッテリープラグをしっかりと差し 込みます、バッテリーの接続, p. 349 を参照。
	間違った電源アダプター	純正の電源アダプターのみをご使用 ください、機能要素と操作要素, p. 347 を参照
	バッテリーもしくは電源アダ プターに欠陥があります	バッテリーもしくは電源アダプター を交換します
	装置に欠陥があります	装置を修理に送ります、修理, p. 367 を参照
少ないバッテリー容量	バッテリーに欠陥があります	バッテリーを交換します、バッテ リーの接続, p. 349 を参照。

7 故障 - 何を行なうか？



故障	原因	何を行なうか？
装置が機能しません。	内部エラー (リセットの実行)	電源プラグを外してピペットボタンを10秒間押し続けます。それから、電源プラグを再びしっかりと差し込みます、バッテリーの接続, p. 349 とピペッティング, p. 355 参照

問題が上記の故障の表によっても解決できない場合には、お客様の専門的な販売店にまたは直接メーカーにお問い合わせください。

8 技術データ

技術データ	値
充電ソケット	5 VDC
電源アダプター	入力：100 – 240 VAC、50/60 Hz 出力：5 VDC
バッテリー	バッテリーパック NiMH 2.4 V、730 mAh 充電時間：4時間 最大作業時間：約8時間 充電温度：+10 °C から +35 °C

8.1 製品の標識

記号または数字	意味
XXZXXXXX	シリアルナンバー
QRコード	シリアルナンバーを含んでいます
	このマークによって製品がEC指令に定められている要件を満たしており、定められている検査手続きを受けていることが証明されます。
	UKCA：United Kingdom Conformity Assessed（英国基準適合評価） このマークによって製品が UK Designated Standards に定められている要件を満たしていることが証明されます。
www.brand.de/ip	特許情報
 (この場合：40年)	中国版RoHS (EFUP) EFUPIは、電気装置や電子装置に含まれている危険物質が通常の運転条件の下で漏出しないか変化しない年数を定めています。ユーザーが普通に使用するとこれらの電気装置や電子装置は、重大な環境汚染、重大な身体への損傷またはユーザーの財産への損害を引き起こすことはありません。

記号または数字	意味
	電気機器は家庭ごみでは処分できません。

9 修理

9.1 修理のための送付

注記

許可を得ずに行なわれる危険な素材の運搬は、法律で禁止されています。

装置をよくクリーニングして汚れを落としてください。

- 製品の返送に基本的に故障の種類と使用した媒体の説明を添えてください。使用した媒体についての届出がないと装置を修理することができません。
- 必ず電池もしくはバッテリーなしで装置を送ってください。
- 返送は、送り主の責任と費用で行ないます。

合衆国とカナダの外

「健康上危惧のないことの宣言」に記入して、装置と一緒にメーカーまたは販売店に送ります。書式は販売店かメーカーに要求するか、www.brand.deでダウンロードできます。

合衆国とカナダの中

装置を整備のために送る **前に** 返送の前提条件をBrandTech Scientific, Inc.とともに明らかにしてください。

必ずクリーニングをして汚れを落とした装置を、返送番号と一緒に入手した住所に送ります。返送番号は、包装の外側に見えるように取り付けます。

連絡先住所

ドイツ :

BRAND GMBH + CO KG
Otto-Schott-Straße 25
97877 Wertheim (Germany)
T +49 9342 808 0
F +49 9342 808 98000
info@brand.de
www.brand.de

合衆国とカナダ :

BrandTech® Scientific, Inc.
11 Bokum Road
Essex, CT 06426-1506 (USA)
T +1-860-767 2562
F +1-860-767 2563
info@brandtech.com
www.brandtech.com

インド :

BRAND Scientific Equipment Pvt. Ltd.
303, 3rd Floor, 'C' Wing, Delphi
Hiranandani Business Park,
Powai
Mumbai-400 076 (India)
T +91 22 42957790
F +91 22 42957791
info@brand.co.in
www.brand.co.in

中国 :

BRAND (Shanghai) Trading Co., Ltd.
Guangqi Culture Plaza
Room 506, Building B
No. 2899, Xietu Road
Shanghai 200030 (P.R. China)
T +86 21 6422 2318
F +86 21 6422 2268
info@brand.com.cn
www.brand.cn.com

10 注文情報

10.1 装置

容器の上の部分のカラー	注文番号 (ユニバーサル電源アダプターと国別のアダプター付き)	注文番号 (ユニバーサル電源アダプターと国別のアダプターなし)
チャコールグレー	26350	26360
ベリー	26351	26361
ガソリン	26352	26362
アメシスト	26353	26363

納品範囲については、を参照。注文番号および電源アダプターの有る無しに注意してください。

10.2 スペアパーツ

スペア膜フィルター

説明	包装単位	注文番号
0.2 μm、滅菌（赤色のカラーコード）	ブリスターパックで1個	26530
0.2 μm	PEバッグで10個	26535
3 μm	ブリスターパックで1個	26052
3 μm	PEバッグで10個	26056

電源アダプター

電源アダプターの技術データについては、技術データ, p. 365 を参照。

型	注文番号
国別のアダプター付きの電源アダプター	26606

バッテリーパック

バッテリーの技術データについては、技術データ, p. 365 を参照。

説明	注文番号
バッテリーパック NiMH	26630

逆止弁付きのシリコンアダプター

説明	注文番号
シリコンアダプター	26508

アダプターの容器

カラー	注文番号
ホワイト	26658

ウォールホルダー

カラー	注文番号
ホワイト	26539

粘着テープ

表
目

包装単位	注文番号
3セット	26547

11 保証

当社は、本装置の不適切な取り扱い、使用、メンテナンス、操作または認可されていない修理の結果に対して、あるいは、特に、ピストン、パッキング、バルブなどの摩耗部品の通常の摩耗の結果に対して、並びにガラスの破損において責任を負いかねます。同様のことが取扱説明書の非遵守にも当てはまります。当社は、特に、本装置を取扱説明書に記載されている以上に分解した場合に、あるいは、その他のアクセサリやスペアパーツを取り付けた場合に発生する損傷に対しては責任を負いかねます。

合衆国とカナダ：

保証についての情報は、www.brandtech.comでご覧いただけます。

12 ゴミ処理



横にあるシンボルは、バッテリー/電池および電気機器は使用期間を終えると家庭ごみ（分別しない集落のゴミ）から分別されて処理されなくてはならないことを表しています。

電気機器は、廃電気電子機器に関する2012年6月4日の欧州議会および理事会指令2012/19/EUに従って、国内のゴミ処理規則に応じて適切な方法でゴミ処理されなくてはなりません。

バッテリーと電池には、環境と人間の健康に悪影響を及ぼす物質が含まれています。したがって、これらは、バッテリーと蓄電池に関する2006年9月6日の欧州議会および理事会指令2006/66/ECに従って、国内のゴミ処理規則に応じて適切な方法でゴミ処理されなくてはなりません。完全に放電したバッテリーと電池のみをゴミ処理します。

EU-Konformitätserklärung | EU Declaration of Conformity

Produktbezeichnung: Product name:	Pipettierhelfer accu-jet® S / Pipetting controller accu-jet® S
Produktvarianten: Product variations:	Anthrazit, Beere, Petrol, Amethyst / anthracite, berry, petrol, amethyst
Art-Nr. / Cat.-No.	26350, 26351, 26352, 26353, 26360, 26361, 26362, 26363

Das oben beschriebene Produkt entspricht den grundlegenden Anforderungen, die in den nachfolgend bezeichneten Harmonisierungsrechtsvorschriften festgelegt sind: The product described above meets the basic requirements that are specified in the harmonization legislation listed below:	Angewendete harmonisierte Normen: Applied harmonized standards:
RoHS: 2011/65/EU incl.2015/863/EU EMC: 2014/30/EU	EN IEC 63000:2018 EN 61326-1:2013
Weitere angewendete Normen: Other applied standards:	Geltungsbereich: Scope:
EN 61010-1:2010, EN 61010-1:2010/A1:2019/AC:2019-04 EN/IEC 62368-1:2014 (angewendet auf Fremdherstellernetzteil / applied to third-party power supply)	NRL / LVD NRL / LVD

Die alleinige Verantwortung für die Ausstellung dieser Konformitätserklärung in Bezug auf die Erfüllung der grundlegenden Anforderungen und die Anfertigung der technischen Unterlagen trägt der Hersteller.

The manufacturer is solely responsible for issuing this declaration of conformity with regard to meeting the essential requirements and preparing the technical documentation.

Hersteller / Manufacturer	Adresse / Address
BRAND GMBH + CO KG	Otto-Schott-Str. 25 97877 Wertheim Germany

Wertheim, 01. Juli 2022 / 01 July 2022



Patrick Ziemeck
Managing Director Technology



i.A. Siegfried Ott
Regulatory Affairs

Diese Erklärung bescheinigt die Übereinstimmung mit den genannten Harmonisierungsvorschriften, beinhaltet jedoch keine Zusicherung von Eigenschaften.

This document declares the accordance with the named harmonized regulations, but does not assure specific properties.

UK Declaration of Conformity

Product name: Pipetting controller accu-jet® S
Product variations: anthracite, berry, petrol, amethyst
Cat.-No. 26350, 26351, 26352, 26353, 26360, 26361, 26362, 26363

The product described above meets the basic requirements that are specified in the harmonization legislation listed below:	Applied harmonized standards:
The Restriction of the Use of Certain Hazardous Substances in Electrical and Electronic Equipment Regulations 2012 (SI 2012 No. 3032)	EN IEC 63000:2018
Electromagnetic Compatibility Regulations 2016 (SI 2016 No. 1091, as amended by SI 2019 No. 696)	EN 61326-1:2013
Other applied standards:	Scope:
EN 61010-1:2010, EN 61010-1:2010/A1:2019/AC:2019-04 EN/IEC 62368-1:2014 (angewendet auf Fremdherstellernetzteil / applied to third-party power supply)	LVD LVD

The manufacturer is solely responsible for issuing this declaration of conformity with regard to meeting the essential requirements and preparing the technical documentation.

Manufacturer	Address
BRAND GMBH + CO KG	Otto-Schott-Str. 25 97877 Wertheim Germany

Wertheim, 18 February 2022



Patrick Ziemeck
Managing Director Technology



i.A. Siegfried Ott
Regulatory Affairs

This document declares the accordance with the named harmonized regulations, but does not assure specific properties.

Declaration of conformity – China RoHS 2

BRAND GMBH + CO KG has made reasonable efforts to ensure that hazardous materials and substances may not be used in BRAND products.

In order to determine the concentration of hazardous substances in all homogeneous materials of the subassemblies, a “Product Conformity Assessment” (PCA) procedure was performed. As defined in GB/T 26572 the “Maximum Concentration Value” limits (MCV) apply to these restricted substances:

+ Lead (Pb):	0.1%	+ Hexavalent chromium (Cr(+VI)):	0.1%
+ Mercury (Hg):	0.1%	+ Polybrominated biphenyls (PBB):	0.1%
+ Cadmium (Cd):	0.01%	+ Polybrominated diphenyl ether (PBDE):	0.1%

Environmental Friendly Use Period (EFUP)

EFUP defines the period in years during which the hazardous substances contained in electrical and electronic products will not leak or mutate under normal operating conditions. During normal use by the user such electrical and electronic products will not result in serious environmental pollution, cause serious bodily injury or damage to the user's assets.

The Environmental Friendly Use Period for BRAND instruments is 40 years.



Material Content Declaration for BRAND Products

部件名称 Part name	有毒有害物质或元素 Hazardous substances					
	铅 Pb	汞 Hg	镉 Cd	六价铬 Cr(+VI)	多溴联苯 PBB	多溴二苯醚 PBDE
包装 / Packaging	0	0	0	0	0	0
塑料外壳 / 组件 Plastic housing / parts	0	0	0	0	0	0
电池 / Battery	0	0	0	0	0	0
玻璃 / Glass	0	0	0	0	0	0
电子电气组件 Electrical and electronic parts	X	0	0	0	0	0
金属外壳 / 组件 Metal housing / parts	X	0	0	0	0	0
电机 / Motor	X	0	0	0	0	0
配件 / Accessories	X	0	0	0	0	0

此表格是按照SJ/T 11364-2014中规定所制定的。

This table is created according to SJ/T 11364-2014.

- O: 表示该有毒有害物质在该部件所有均质材料中的含量均在GB/T 26572规定的限量要求以下。
O: Indicates that the above mentioned hazardous substance contained in all homogeneous materials of the part is below the required limit as defined in GB/T 26572.
- X: 表示该有毒有害物质至少在该部件某一均质材料中的含量超出GB/T 26572规定的限量要求。
X: Indicates that the above mentioned hazardous substance contained in at least one of the homogeneous materials of this part is above the required limit as defined in GB/T 26572.

注释： 电池，玻璃制品和配件可能不属于此设备的一部分且/或可能有它自己的EFUP标志且/或可能包含更改EFUP标志的部件。

Note: Batteries, glassware and accessories might not be content of the enclosed device and/or may have their own EFUP-marking and/or might be maintaining parts with changing EFUP-marking.

除上表所示信息外，还需声明的是，这些部件并非是有用铅 (Pb), 汞 (Hg), 镉 (Cd), 六价铬 (Cr(+VI)), 多溴联苯 (PBB) 或多溴二苯醚 (PBDE) 来制造的。

Apart from the disclosures in the above table, the subassemblies are not intentionally manufactured or formulated with lead (Pb), mercury (Hg), cadmium (Cd), hexavalent chromium (Cr+VI), polybrominated biphenyls (PBB), and polybrominated diphenyl ethers (PBDE).

Products manufactured by BRAND may enter into further devices or can be used together with other appliances. With these third party products and appliances in particular, please note the EFUP labeled on these products. BRAND will not take responsibility for the EFUP of those products and appliances.

Place, date: Wertheim, 05|04|2022



Patrick Ziemeck
(Managing Director Technology)



i.A. Siegfried Ott
(Regulatory Affairs)

Tartalomjegyzék

1	Bevezető.....	380
1.1	A szállítási terjedelem	380
1.2	A rendeltetésszerű használat	380
2	Biztonság.....	382
2.1	Funkció	383
2.2	Alkalmazási korlátok.....	383
2.3	Alkalmazási kizárások	384
2.4	Tárolási feltételek	384
3	Funkciós és kezelőelemek	385
4	Használatbavétel	387
4.1	Az akku csatlakoztatása.....	387
4.2	Az akku töltése	389
4.3	A készülék beindítása.....	390
4.4	Az üzemmód kiválasztása.....	390
4.5	Folyadék felszívása vagy leadása	390
4.6	A pipettázási sebesség megváltoztatása	391
4.7	A motorfordulatszám beállítása.....	391
4.8	A készülék tárolása.....	391
5	Pipettázás.....	393
6	Tisztítás.....	395
6.1	A tömítettség ellenőrzése	395
6.2	A szűrő cseréje és az adapter megtisztítása	395
6.3	UV-csírátlanítás	398
7	Zavar - Mi a teendő?	399
8	Műszaki adatok	400
8.1	A terméken való megjelölés	400
9	Javítás.....	401
9.1	Javításra való beküldés	401

10 Megrendelésre vonatkozó információk.....	403
10.1 Készülék.....	403
10.2 Alkatrészek	403
11 Jótállás.....	405
12 Hulladékeltávolítás	406

1 Bevezető

1.1 A szállítási terjedelem

Pipettázó segédanyag, nikkél-fém-hidrid akku, tápegység opcionálisan (a különböző rendelési számokat figyelembe kell venni), 2 pót membránszűrő 0,2 µm, fal tartó, használati útmutató

1.2 A rendeltetészerű használat

- Az első használat előtt olvassa el gondosan a használati útmutatót.
- A használati útmutató a készülék részét képezi és azt könnyen elérhető helyen kell tárolni.
- Mellékelje a használati útmutatót, ha a készüléket átadná harmadik félnek.

1.2.1 Veszélyeztetési fokozatok

A lehetséges veszélyeket a következő figyelmeztető szavak jelzik:

Figyelmeztető szó	Jelentés
VESZÉLY	Súlyos sérülésekhez vagy halálhoz vezet.
VIGYÁZAT	Súlyos sérülésekhez vagy halálhoz vezethet.
FIGYELEM	Könnyű vagy közepesen súlyos sérülésekhez vezethet.
MEGJEGYZÉS	Anyagi károkhoz vezethet.

1.2.2 A használati útmutatóban használt szimbólumok

Szimbólum	Jelentés	Szimbólum	Jelentés
	Veszélyes terület		Robbanásveszély
	Viseljen szemvédőt		Viseljen védőkesztyűt

1.2.3 Ábrázolás

Ábrázolás	Jelentés	Ábrázolás	Jelentés
1. task	Egy feladatot jelöl.	>	Egy előfeltételt jelöl.
a., b., c.	A feladat egyes lépéseit jelöli.	⇒	Egy eredményt jelöl.

2 Biztonság

Kérjük, mindenképpen gondosan olvassa el!

A accu-jet® S laboratóriumi készülék veszélyen anyagokkal, munkafolyamatokkal és berendezésekkel kombinálva használható. A használati útmutató nem tudja felsorolni az összes a biztonságot veszélyeztető problémát, amely a használat során felléphet. A felhasználó felelőssége gondoskodni a biztonsági és egészségügyi előírások betartásáról, és a megfelelő korlátozások rögzítése a használat előtt.

1. Valamennyi felhasználó köteles elolvasni a készülék használata előtt a jelen használati útmutatót, és azt be kell tartania.
2. Be kell tartani a veszélyekre vonatkozó általános figyelmeztetéseket és biztonsági előírásokat, pl. a védőruházat, a szemvédő és a védőkesztyű viselését.
3. A reagensek gyártójának adatait figyelembe kell venni.
4. A készülék nem üzemeltethető robbanásveszélyes atmoszférában, és azzal tilos könnyen gyulladó anyagokat pipettázni.
5. A készülék csak folyadékok pipettázására használható, és csak a meghatározott alkalmazási korlátok betartásával. Az alkalmazási kizárásokat figyelembe kell tartani, lásd ehhez Alkalmazási kizárások, oldal 384 ! Felmerülő kétség esetén mindenképpen a gyártóhoz vagy a kereskedőhöz kell fordulni.
6. Mindig úgy kell dolgozni, hogy a munkavégzés során se a felhasználó, se más személyek ne sérüljenek meg. Kerülje el a fröccsenéseket. Csak megfelelő edényeket lehet használni.
7. Soha ne alkalmazzon erőszakot.
8. Csak eredeti tartozékokat és eredeti alkatrészeket használjon. Ne végezzen semmilyen műszaki változtatást a készüléken. Ne szedje szét jobban a készüléket, mint ahogyan azt a használati útmutatóban leírták!

9. Az alkalmazás előtt ellenőrizze a készülék előírásoknak megfelelő állapotát. Amennyiben zavarok jelentkeznének a készüléken, azonnal abba kell hagyni a pipettázást és követni kell a Zavar - Mi a teendő? részben leírtakat. Adott esetben a gyártóhoz kell fordulni.
10. A nikkell-fém-hibrid akku feltöltéséhez csak az eredeti tápegység használható.
11. Az akku nem cserélhető más gyártók akkuira.
12. A tápegységet védeni kell a nedvességtől és azt csak a jelen készülékkel lehet üzemeltetni.
13. Ne használja tovább a tápegységet, ha a csatlakozó vezeték megroggálódott.
14. A készüléken végzendő javításokat és beavatkozásokat csak arra felhatalmazott szerviztechnikus végezheti el.

2.1 Funkció

A készülék pipettázó segédeszközként szolgál folyadékok üveg vagy műanyag 0,1 ml - 200 ml űrtartalmú és < 9,2 mm-es szívócső-átmérőjű mérő- és telepipetták használatakor. A megfelelő alkalmazás során a felszívott folyadék csak a pipettával lép érintkezésbe.

2.2 Alkalmazási korlátok

A készülék folyadékok pipettázására szolgál a következő fizikális határok figyelembe vétele mellett:

- +10 °C és +40 °C (50 °F és 104 °F) között (készülék és reagens)
- gőznyomás max. 500 mbar-ig. 300 mbar felett lassan kell felszívni, hogy el lehessen kerülni a folyadék forrását.
- Sűrűség max. 9 g/cm³

2.3 Alkalmazási kizárások

A készülék nem használható olyan folyadékokhoz, amelyek gőze korrodáló hatású. ill. megtámadja a szilikont és az EPDM anyagokat.

A készülék nem alkalmas Pasteur-pipettával való használatra.

FIGYELMEZTETÉS



A készülék üzemeltetése robbanásveszélyes környezetben

A készülék nem üzemeltethető és nem tölthető robbanásveszélyes környezetben. Tilos könnyen gyulladó anyagokat pipettázni (lobbanáspont 0 °C (32 °F) alatt, pl. éter, aceton).

2.4 Tárolási feltételek

A készüléket és a tartozékokat csak megtisztított állapotban lehet hűvösen és szárazon tárolni.

Tárolási hőmérséklet: -20 °C és + 50 °C (-4 °F és 122 °F) között.

A levegő relatív nedvességtartalma: 5 % és 95 % között.

3 Funkciós és kezelőelemek

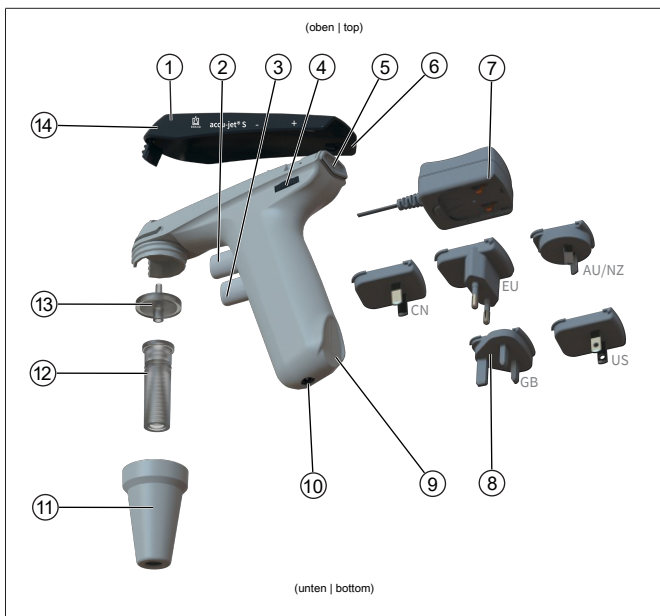

- | | |
|--|---|
| 1 ház felső része | 2 felső pipettázó gomb (folyadékfelvétel) |
| 3 alsó pipettázó gomb (folyadékleadás) | 4 a motorfordulatszámot beállító kerék |
| 5 üzemmód-kiválasztó kapcsoló | 6 leállítási terület a ház felső részén |
| 7 tápegység | 8 országonként különböző adapter |
| 9 leállítási terület a markolaton | 10 töltő hüvely |
| 11 adapterház (PP) | 12 adapter/visszacsapó szelep (SI/PTFE) |
| 13 membránszűrő (PP/PTFE) | 14 nyomáskiegyenlítő nyílás |

A feszültségre és az áramfelvételre vonatkozó adatokat lásd Műszaki adatok, oldal 400 .

röv.	anyag
PP	polipropilén

3 Funkció és kezelőelemek

röv.	anyag
PTFE	politetrafluoretilén
SI	szilikon

4 Használatbavétel

4.1 Az akku csatlakoztatása

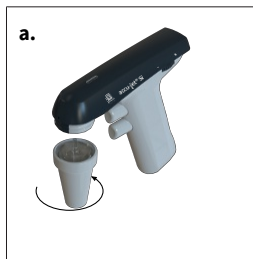

- a.** Csavarozza le az adapterházat. Az adapter és a szűrő az adapterházban maradnak.

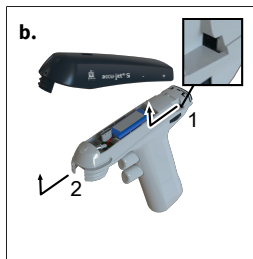

- b.** Vegye le a házat. Tolja a házat kicsit az adapterház csavarkötése felé.
- ⇒ A ház leválik a kimunkálásokról a beállító kerék (1) fölött, valamint az adapterház csavarkötéséből (2).
- ⇒ Az akkurekesz láthatóvá válik.

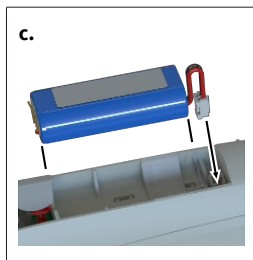

- c.** Tartsa az akku dugóját a kábelnél fogva, igazítsa be azt megfelelően és dugja azt szorosan a hüvelybe, míg az hallhatóan be nem kattán. Helyezze be az akkut.

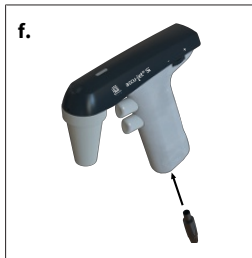
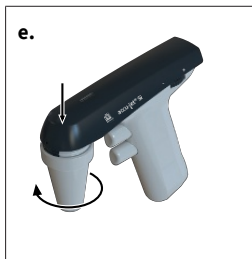
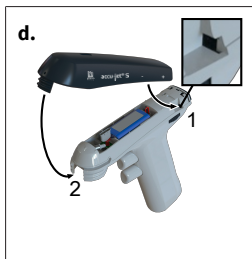

d. Helyezze be a házat. Ennek során figyeljen arra, hogy a ház beakadjon az arra kijelölt kimunkálásokba a beállító kerék (1) felett, valamint az adapterház csavarozásába (2).

e. Nyomja a ház felső részét a ház alsó részébe és csavarozza fel az adapterházat.

f. Töltse fel az akkut, míg a LED töltésjelző zölden nem villog. Töltési idő kb. 4 óra, lásd az Az akku töltése.

4.2 Az akku töltése

⚠ FIGYELMEZTETÉS



Megrongálódott tápegység vagy töltő kábel

Áramütés okozta sérülésveszély.



- > Ne használjon megrongálódott tápegységet.
- > Amennyiben a töltő kábel megrongálódott, ne használja újra a tápegységet.

TUDNIVALÓ

Csak a gyártó eredeti tápegységét használja!

Más tápegység használata megrongálhatja a készüléket és az akkut.

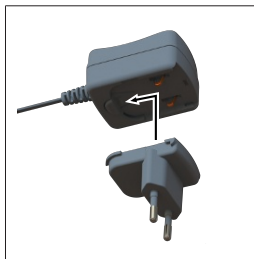

- a. Csatlakoztassa az országban érvényes adaptert a tápegységre.
 - b. Csatlakoztassa a tápegységet a készülékhez.
 - c. Dugja a tápegységet a hálózati csatlakozóba.
- ⇒ Megkezdődik a készülék töltése. Ez a ház felső részén lévő LED-es töltéskijelzőn ismerhető fel. Az üzem- és töltési idő tekintetében lásd Műszaki adatok, oldal 400.

A LED-es töltéskijelző	Státusz	Mi a teendő?
zöld: villog	Az akkut feltöltötték. Fenntartó töltést végez.	A készülék használható. A készüléket teljesen feltöltötték.
zöld: folyamatosan világít	Az akku tölt	A töltés közben is tovább dolgozhat a készülékkel.
piros: villog	Az akku majdnem teljesen lemerült.	Szakítsa meg a készülékkel való munkavégzést. Töltse fel az akkut. A töltés közben is tovább dolgozhat a készülékkel.

A LED-es töltéskijelző	Státusz	Mi a teendő?
piros: folyamatosan világít	Az akku lemerült.	Töltse fel az akkut.

TUDNIVALÓ

- > A fenntartó töltés megakadályozza a túltöltést, és csökkenti a „lazy-battery” hatást. A maximális kapacitás eléréséhez az akkut csak akkor töltse fel, ha azt a LED-es töltéskijelző jelzi.

4.3 A készülék beindítása

A készülék üzemkész, ha behelyeztek egy feltöltött akkut. ON/OFF-kapcsoló nincs a készüléken.

4.4 Az üzemmód kiválasztása

Kiválasztó kapcsoló, lásd Funkciós és kezelőelemek, oldal 385 .

„Szabad lefolyás” üzemmód: tolja fel a kiválasztó kapcsolót.

„Kifújás motor segítségével” üzemmód: tolja le a kiválasztó kapcsolót.

4.5 Folyadék felszívása vagy leadása

Pipettázó gomb, lásd Funkciós és kezelőelemek, oldal 385

A pipetta betöltéséhez nyomja meg a felső pipettázó gombot a folyadék ürítéséhez nyomja meg az alsó pipettázó gombot.

4.6 A pipettázási sebesség megváltoztatása

A sebességet a beállított maximális motorfordulatszám korlátozza. Minél hosszabb ideig tartják benyomva a felső vagy az alsó pipettázó gombot, annál gyorsabban szívja fel a folyadékot, vagy üríti ki azt.

4.7 A motorfordulatszám beállítása

Beállító kerék, lásd Funkciós és kezelőelemek, oldal 385

A motor fordulatszámát fokozatmentesen be lehet állítani a maximumtól (+) a minimumig (-) a beállító kerék elforgatásával. Mi a nagy űrtartalmú pipettákhoz a maximális fordulatszámot javasoljuk, a kisebb űrtartalmú pipettákhoz a kisebb fordulatszámot.

4.8 A készülék tárolása

4.8.1 Asztalra állítás

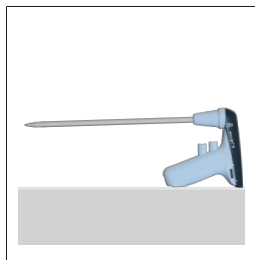

A **accu-jet® S** leállítható egy egyenletes felületre a behelyezett pipettával együtt.

4.8.2 Fali tartó



- a. A rögzítési felületet a megfelelő tisztítószerrel (nem zsírpótló hatású háztartási tisztítószerrel) és egy nem szőszelő kendővel meg kell tisztítani és alaposan meg kell szárítani.
- b. Húzza le a védőfóliát a ragasztó csíkről
- c. Nyomja a fali tartót **szorosán** a rögzítési felületre.

5 Pipettázás

1. A pipetta felhelyezése

▲ FIGYELMEZTETÉS



Figyeljen a pipetta szoros illeszkedésére. Soha ne alkalmazzon erőszakot! Különösen vékony pipetták esetén fennáll annak a veszélye, hogy az üveg eltörik! Sérülésveszély!

1.



- a. A pipettát mindig lehetőleg a felső részéhez közel fogva kell megtartani és óvatosan be kell azt tolni az adapterbe, míg az szorosan be nem illeszkedik.
- b. A készüléket a behelyezett pipettával mindig függőlegesen kell tartani, a hegygel lefelé.

2. A pipetta feltöltése

2.

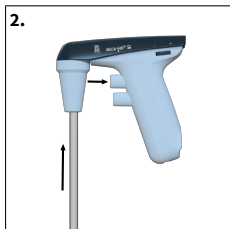

- a. Merítse a pipetta hegyét a folyadékba.
- b. Nyomja be lassan a pipettázó gombot, és töltsé be a pipettát úgy, hogy a meniszkusz kicsit a kívánt mennyiség fölött legyen.
- c. Amennyiben mindkét pipettázó gombot megnyomják, úgy a folyadékot nagyon finoman lehet felszívni vagy kiüríteni. Ez különösen akkor nagy se-

gítség, ha be akarja állítani a meniszkuszt, vagy kis űrtartalmú pipettákat használna.

TUDNIVALÓ

Ne töltse túl a pipettákat.

3. Az űrtartalom beállítása

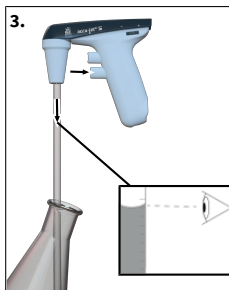

- a. Adott esetben törölje le a pipetta hegyét a megfelelő nem szőszölő kendővel.
- b. Nyomja be lassan az alsó pipettázó gombot, és ürítse ki annyira a folyadékot, míg a meniszkuszt pontosan a kívánt mennyiségre nem áll.

4. A pipetta kiürítése

- a. Nyomja be lassan az alsó pipettázó gombot. A pipettázás sebessége attól függ, mennyire nyomja be a pipettázó gombot. A „Kifújás motor segítségével“ üzemmódban ez a beállított motorfordulatszámától is függ.

5. A pipettázás után

- a. Fogja meg lehetőleg felül a pipettát és húzza ki azt az adapterből.

6 Tisztítás

TUDNIVALÓ

A **accu-jet® S** nem autoklávozható

A ház elemeit alkalmanként le kell törölni egy nedves kendővel. Az előírásoknak megfelelő használat esetén a készülék nem igényel karbantartást.

6.1 A tömítettség ellenőrzése

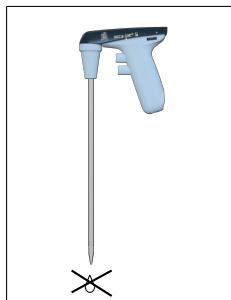

A meniszkusz beállítása után a szelepek működtetése nélkül nem csöpöghet ki folyadék a pipetából. Amennyiben a pipetta csöpög, lásd Zavar - Mi a teendő?

6.2 A szűrő cseréje és az adapter megtisztítása

▲ FIGYELMEZTETÉS



Kontaminációs és fertőzési veszély

Viseljen védőkesztyűt és szemvédőt.



TUDNIVALÓ

A szűrő cseréjére vagy tisztításra csak akkor van szükség, ha a pipettát túltöltötték vagy a szívóteljesítmény befolyásolt.

b.



- a. Húzza ki a pipettát.
- b. Csavarozza le az adapterházat.
- c. Vegye le a ház felső részét.

d.



- d. Nyomja ki az adaptert és a membrán-szűrőt az adapterház kúpos felétől fogva.

e.



- e. Húzza le a meghibásodott membrán-szűrőt.

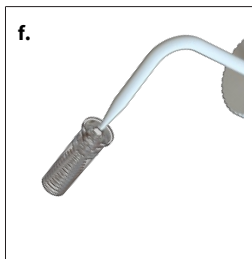

- f.** Az adapter megtisztításakor mossa át azt alaposan egy injekciós palackkal, amelyet egy megfelelő tisztító folyadékkal, pl. vízzel, töltöttek fel. Ezután fújja ki és hagyja megszáradni.

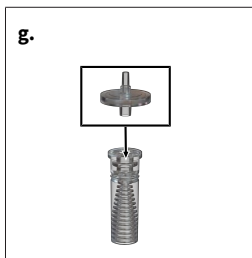

- g.** Először dugja az új membránszűrőt a vastagabb csatlakozással lefelé az adapterbe (a vékonyabb, kúpos fele felfelé néz), és helyezze az adapterházába.

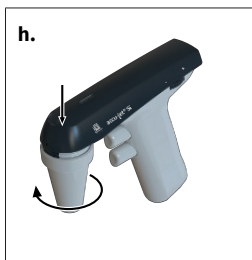

- h.** Nyomja a ház felső részét a ház alsó részébe és csavarozza fel az adapterházat.

TUDNIVALÓ**Az autoklávozható szűrőkre vonatkozó megjegyzés**

Az autoklávozás hatékonyságát az alkalmazónak magának kell ellenőriznie. Nem minden membránszűrő alkalmas erre! Csak eredeti alkatrészt használjon.

- > Szabványosan a készüléket 0,2 µm-es membránszűrővel (piros színkód) látták el.
 - > A membránszűrő akár ötször 121 °C-on (250 °F-on) autoklávozható.
 - > A 0,2 µm-es membránszűrővel (sejtkultúrákhoz) B osztályba tartozó úrtartalomtűrés érhető el.
 - > Az A osztályba tartozó úrtartalomtűrés betartásához 3 µm-es membránszűrő szükséges. Ezek a nagyobb pórusméretek miatt kisebb hatással bírnak a pipetták szabad lefolyási idejére, lásd .
-

6.3 UV-csírátlanítás

A készülék ellenáll az UV-csírátlanító lámpa szokásos igénybevételének. Az UV-hatás következtében színváltozás léphet fel.

7 Zavar - Mi a teendő?





Zavar	Ok	Mi a teendő?
A szívóteljesítmény csökken	A motor fordulatszáma csökkent	Növelje a motor fordulatszámát, lásd A motorfordulatszám beállítása, oldal 391 .
	A visszacsapó szelep zárva van	Állítsa a választó kapcsolót kifújásra és nyomja meg az alsó pipettázó gombot, lásd Üzem mód kiválasztása, oldal 390
A pipetta csöpög	A szűrő nem jól illeszkedik be	Helyezze be megfelelően a szűrőt, lásd A szűrő cseréje és az adapter megtisztítása, oldal 395 .
	Az adapter vagy a pipetta megrongálódott	Cserélje ki az adaptert vagy a pipettát, lásd A szűrő cseréje és az adapter megtisztítása, oldal 395 .
A pipetta nem marad bent az adapterben	Az adapter elszennyeződött, ill. megrongálódott	Tisztítsa meg az adaptert, hagyja azt megszáradni a levegőn, ill. cserélje ki azt, lásd A szűrő cseréje és az adapter megtisztítása, oldal 395 .
A LED-es töltéskijelző nem világít/villog, miután csatlakoztatta a tápegységet és létrehozta a feszültségellátást.	Az akkus csatlakozót nem csatlakoztatták szorosan	Dugja be szorosan az akkus csatlakozót, lásd Akku csatlakoztatása, oldal 387
	Nem megfelelő tápegység	Csak eredeti tápegységet használjon, lásd Funkciók és kezelőelemek, oldal 385
	Az akku, ill. tápegység megrongálódott	Cserélje ki az akkut/tápegységet
	A készülék meghibásodott	Küldje be megjavíttatni a készüléket, lásd Javítás, oldal 401
Túl alacsony akkukapacitás	Az akku meghibásodott	Cserélje ki az akkut, lásd Akku csatlakoztatása, oldal 387 .
A készülék nem működik	Belső hiba (végezzen resetet)	Oldja ki az akkus csatlakozót, és tartsa benyomva az egyik pipettázó gombot 10 másodpercig. Ezután dugja vissza szorosan az akkus csatlakozót, lásd Akku csatlakoztatása, oldal 387 és Pipettázás, oldal 393

Amennyiben a zavar a fenti zavartáblázat segítségével nem hárítható el, forduljon a szakkereskedőhöz, vagy közvetlenül a gyártóhoz.

8 Műszaki adatok

Műszaki adatok	Értékek
töltő hüvely	5 VDC
tápegység	Input: 100 – 240 VAC, 50/60 Hz Output: 5 VDC
akku	NiMH akkuegység 2,4 V, 730 mAh töltési idő: 4 h Maximális üzemidő: kb. 8 h töltő hőmérséklet: +10 °C és +35 °C között

8.1 A terméken való megjelölés

Jelek vagy számok	Jelentés
XXZXXXXX	Sorozatszám
Quick Response Code	Tartalmazza a sorozatszámot
	Ezzel a jelzéssel igazoljuk, hogy a termék megfelel az EK irányelvekben meghatározott követelményeknek és azt alávetettük a meghatározott ellenőrzéseknek.
	UKCA: United Kingdom Conformity Assessed Ezzel a jelzéssel igazoljuk, hogy a termék megfelel az UK Designated Standards meghatározott követelményeinek.
www.brand.de/ip	Szabadalmi információk
 (itt: 40 év)	A China RoHS (EFUP) EFUP azt az időszakot határozza meg évben kifejezve, amely idő alatt az elektromos és elektronikus berendezésekben lévő veszélyes anyagok normál üzemi körülmények között nem szivárognak ki és nem változnak meg. A felhasználó általi normális használat során az ilyen elektromos és elektronikus termékek nem okoznak súlyos környezetszennyezést, súlyos testi sérülést vagy a felhasználó tulajdonának károsodását.
	Az elektronikus készüléket nem lehet a háztartási hulladékba dobni.

9 Javítás

9.1 Javításra való beküldés

TUDNIVALÓ

A veszélyes anyagok szállítása engedély nélkül törvényileg tilos.

A készüléket alaposan meg kell tisztítani és fertőtleníteni kell!

- A termékek visszaküldésekor kérjük, mindig mellékeljen egy pontos zavarleírást és az alkalmazott anyagok listáját. A nem közölt felhasznált anyagok esetén a készülék nem javítható meg.
- A készüléket kizárólag akku, ill. elemek nélkül lehet beküldeni.
- A visszaszállítás a beküldő felelőssége és költsége.

Az USA-n és Kanadán kívül

Töltse ki az „Egészségügyi biztonságról szóló nyilatkozatot” és küldje el a gyártónak vagy a kereskedőnek a készülékkel együtt. A nyomtatvány a kereskedőnél vagy a gyártónál lekérhető, ill. a www.brand.de honlapról letölthető.

Az USA-n és Kanadán belül

Kérjük, tisztázza a BrandTech Scientific, Inc. Céggel a visszaküldés feltételeit, **mielőtt** beküldené a szervizbe a készüléket.

Kizárólag tiszta és fertőtlenített készülékeket lehet beküldeni arra a címre, amelyet a visszaküldési számmal együtt megkapott. A visszaküldési számot jól láthatóan fel kell tüntetni a csomagon kívül.

Kapcsolattartási címek

Németország:

BRAND GMBH + CO KG
Otto-Schott-Straße 25
97877 Wertheim (Germany)
Tel.: +49 9342 808 0
Fax: +49 9342 808 98000
info@brand.de
www.brand.de

USA és Kanada:

BrandTech® Scientific, Inc.
11 Bokum Road
Essex, CT 06426-1506 (USA)
T +1-860-767 2562
F +1-860-767 2563
info@brandtech.com
www.brandtech.com

India:

BRAND Scientific Equipment Pvt. Ltd.
303, 3rd Floor, 'C' Wing, Delphi
Hiranandani Business Park,
Powai
Mumbai-400 076 (India)
T +91 22 42957790
F +91 22 42957791
info@brand.co.in
www.brand.co.in

Kína:

BRAND (Shanghai) Trading Co., Ltd.
Guangqi Culture Plaza
Room 506, Building B
No. 2899, Xietu Road
Shanghai 200030 (P.R. China)
Tel.: +86 21 6422 2318
Fax: +86 21 6422 2268
info@brand.com.cn
www.brand.cn.com

10 Megrendelésre vonatkozó információk

10.1 Készülék

A ház felső részének színe	Rendelési szám (univerzális tápegységgel és ország szerinti adapterrel)	Rendelési szám (univerzális tápegység és ország szerinti adapter nélkül)
antracit	26350	26360
lila	26351	26361
petrolzöld	26352	26362
ametiszt	26353	26363

A szállítási terjedelem, lásd . Vegye figyelembe a rendelési számokat, tápegységgel és anélkül.

10.2 Alkatrészek

Pót membránszűrő

Leírás	Csom.-egys.	Rendelési szám
0,2 µm, steril (piros színkód)	1 db buborékfóliás csomagolásban	26530
0,2 µm	10 db PE-zacskóban	26535
3 µm	1 db buborékfóliás csomagolásban	26052
3 µm	10 db PE-zacskóban	26056

Tápegység

A tápegység műszaki adatai, lásd Műszaki adatok, oldal 400 .

Típus	Rendelési szám
Tápegység az országban érvényes adapterrel	26606

Akkuegység

Az akkuegység műszaki adatai, lásd Műszaki adatok, oldal 400 .

Leírás	Rendelési szám
NiMH akkuegység	26630

Szilikon adapter visszacsapó szeleppel

Leírás	Rendelési szám
Szilikon adapter	26508

Adapterház

Szín	Rendelési szám
fehér	26658

Fali tartó

Szín	Rendelési szám
fehér	26539

Tartószalag

Csom. egys.	Rendelési szám
3 készlet	26547

11 Jótállás

Nem vállalunk felelősséget a készülék nem megfelelő kezeléséből, használatából, karbantartásából, üzemeltetéséből vagy jogosulatlan javításából eredő következményekért, illetve a szokásos kopás következményeiért, különös tekintettel az olyan kopó alkatrészekre, mint a dugattyúk, tömítések, szelepek, illetve üvegtörés esetén. Ugyanez vonatkozik a használati útmutató be nem tartására. Különösen nem vállalunk felelősséget az olyan károkért, amelyek akkor keletkeznek, ha a készüléket a használati utasításban leírtaknál jobban szétszerelték, vagy ha harmadik féltől származó tartozékokat vagy pótalkatrészeket szereltek be.

USA és Kanada:

A jótállásra vonatkozó információkat megtalálhatja a www.brandtech.com honlapon.

12 Hulladékeltávolítás



A melléklet szimbólum azt jelenti, hogy az elemeket/akkumulátorokat és az elektronikus eszközöket élettartamuk végén a háztartási hulladéktól (nem válogatott települési hulladéktól) elkülönítve kell ártalmatlanítani.

Az Európai Parlament és a Tanács 2012. július 4-i, az elhasznált elektromos és elektronikus berendezésekről szóló 2012/19/EU sz. irányelve értelmében az elektronikus berendezéseket a nemzeti hulladékkezelési előírásoknak megfelelően kell ártalmatlanítani.

Az elemek és az akkumulátorok olyan anyagokat tartalmaznak, amelyek károsak lehetnek a környezetre és az emberi egészségre. Az Európai Parlament és a Tanács 2006. szeptember 6-i 2006/66/EK sz. irányelve értelmében az elemeket és az akkumulátorokat a nemzeti hulladékkezelési előírásoknak megfelelően kell ártalmatlanítani. Csak teljesen lemerült elemeket és akkumulátorokat lehet a hulladékeltávolításba dobni.

EU-Konformitätserklärung | EU Declaration of Conformity

Produktbezeichnung: Product name:	Pipettierhelfer accu-jet® S / Pipetting controller accu-jet® S
Produktvarianten: Product variations:	Anthrazit, Beere, Petrol, Amethyst / anthracite, berry, petrol, amethyst
Art-Nr. / Cat.-No.	26350, 26351, 26352, 26353, 26360, 26361, 26362, 26363

Das oben beschriebene Produkt entspricht den grundlegenden Anforderungen, die in den nachfolgend bezeichneten Harmonisierungsrechtsvorschriften festgelegt sind: The product described above meets the basic requirements that are specified in the harmonization legislation listed below:	Angewendete harmonisierte Normen: Applied harmonized standards:
RoHS: 2011/65/EU incl.2015/863/EU EMC: 2014/30/EU	EN IEC 63000:2018 EN 61326-1:2013
Weitere angewendete Normen: Other applied standards:	Geltungsbereich: Scope:
EN 61010-1:2010, EN 61010-1:2010/A1:2019/AC:2019-04 EN/IEC 62368-1:2014 (angewendet auf Fremdherstellernetzteil / applied to third-party power supply)	NRL / LVD NRL / LVD

Die alleinige Verantwortung für die Ausstellung dieser Konformitätserklärung in Bezug auf die Erfüllung der grundlegenden Anforderungen und die Anfertigung der technischen Unterlagen trägt der Hersteller.

The manufacturer is solely responsible for issuing this declaration of conformity with regard to meeting the essential requirements and preparing the technical documentation.

Hersteller / Manufacturer	Adresse / Address
BRAND GMBH + CO KG	Otto-Schott-Str. 25 97877 Wertheim Germany

Wertheim, 01. Juli 2022 / 01 July 2022



Patrick Ziemeck
Managing Director Technology



i.A. Siegfried Ott
Regulatory Affairs

Diese Erklärung bescheinigt die Übereinstimmung mit den genannten Harmonisierungsvorschriften, beinhaltet jedoch keine Zusicherung von Eigenschaften.

This document declares the accordance with the named harmonized regulations, but does not assure specific properties.

UK Declaration of Conformity

Product name: Pipetting controller accu-jet® S
Product variations: anthracite, berry, petrol, amethyst
Cat.-No. 26350, 26351, 26352, 26353, 26360, 26361, 26362, 26363

The product described above meets the basic requirements that are specified in the harmonization legislation listed below:	Applied harmonized standards:
The Restriction of the Use of Certain Hazardous Substances in Electrical and Electronic Equipment Regulations 2012 (SI 2012 No. 3032)	EN IEC 63000:2018
Electromagnetic Compatibility Regulations 2016 (SI 2016 No. 1091, as amended by SI 2019 No. 696)	EN 61326-1:2013
Other applied standards:	Scope:
EN 61010-1:2010, EN 61010-1:2010/A1:2019/AC:2019-04 EN/IEC 62368-1:2014 (angewendet auf Fremdherstellernetzteil / applied to third-party power supply)	LVD LVD

The manufacturer is solely responsible for issuing this declaration of conformity with regard to meeting the essential requirements and preparing the technical documentation.

Manufacturer	Address
BRAND GMBH + CO KG	Otto-Schott-Str. 25 97877 Wertheim Germany

Wertheim, 18 February 2022

Patrick Ziemeck
Managing Director Technology

i.A. Siegfried Ott
Regulatory Affairs

This document declares the accordance with the named harmonized regulations, but does not assure specific properties.

Declaration of conformity – China RoHS 2

BRAND GMBH + CO KG has made reasonable efforts to ensure that hazardous materials and substances may not be used in BRAND products.

In order to determine the concentration of hazardous substances in all homogeneous materials of the subassemblies, a “Product Conformity Assessment” (PCA) procedure was performed. As defined in GB/T 26572 the “Maximum Concentration Value” limits (MCV) apply to these restricted substances:

+ Lead (Pb):	0.1%	+ Hexavalent chromium (Cr(+VI)):	0.1%
+ Mercury (Hg):	0.1%	+ Polybrominated biphenyls (PBB):	0.1%
+ Cadmium (Cd):	0.01%	+ Polybrominated diphenyl ether (PBDE):	0.1%

Environmental Friendly Use Period (EFUP)

EFUP defines the period in years during which the hazardous substances contained in electrical and electronic products will not leak or mutate under normal operating conditions. During normal use by the user such electrical and electronic products will not result in serious environmental pollution, cause serious bodily injury or damage to the user's assets.

The Environmental Friendly Use Period for BRAND instruments is 40 years.



Material Content Declaration for BRAND Products

部件名称 Part name	有毒有害物质或元素 Hazardous substances					
	铅 Pb	汞 Hg	镉 Cd	六价铬 Cr(+VI)	多溴联苯 PBB	多溴二苯醚 PBDE
包装 / Packaging	0	0	0	0	0	0
塑料外壳 / 组件 Plastic housing / parts	0	0	0	0	0	0
电池 / Battery	0	0	0	0	0	0
玻璃 / Glass	0	0	0	0	0	0
电子电气组件 Electrical and electronic parts	X	0	0	0	0	0
金属外壳 / 组件 Metal housing / parts	X	0	0	0	0	0
电机 / Motor	X	0	0	0	0	0
配件 / Accessories	X	0	0	0	0	0
此表格是按照SJ/T 11364-2014中规定所制定的。 This table is created according to SJ/T 11364-2014.						

- O: 表示该有毒有害物质在该部件所有均质材料中的含量均在GB/T 26572规定的限量要求以下。
O: Indicates that the above mentioned hazardous substance contained in all homogeneous materials of the part is below the required limit as defined in GB/T 26572.
- X: 表示该有毒有害物质至少在该部件某一均质材料中的含量超出GB/T 26572规定的限量要求。
X: Indicates that the above mentioned hazardous substance contained in at least one of the homogeneous materials of this part is above the required limit as defined in GB/T 26572.

注释： 电池，玻璃制品和配件可能不属于此设备的一部分且/或可能有它自己的EFUP标志且/或可能包含更改EFUP标志的部件。

Note: Batteries, glassware and accessories might not be content of the enclosed device and/or may have their own EFUP-marking and/or might be maintaining parts with changing EFUP-marking.

除上表所示信息外，还需声明的是，这些部件并非是有用铅 (Pb), 汞 (Hg), 镉 (Cd), 六价铬 (Cr(+VI)), 多溴联苯 (PBB) 或多溴二苯醚 (PBDE) 来制造的。

Apart from the disclosures in the above table, the subassemblies are not intentionally manufactured or formulated with lead (Pb), mercury (Hg), cadmium (Cd), hexavalent chromium (Cr+VI), polybrominated biphenyls (PBB), and polybrominated diphenyl ethers (PBDE).

Products manufactured by BRAND may enter into further devices or can be used together with other appliances. With these third party products and appliances in particular, please note the EFUP labeled on these products. BRAND will not take responsibility for the EFUP of those products and appliances.

Place, date: Wertheim, 05|04|2022



Patrick Ziemeck
(Managing Director Technology)



i.A. Siegfried Ott
(Regulatory Affairs)

1 Úvod	413
1.1 Rozsah dodávky	413
1.2 Návod k použití	413
2 Bezpečnost	415
2.1 Funkce	416
2.2 Meze použití	416
2.3 Vyloučení použití	416
2.4 Podmínky skladování	417
3 Funkční a ovládací prvky	418
4 Uvedení do provozu	420
4.1 Připojení akumulátoru	420
4.2 Nabíjení akumulátoru	422
4.3 Spuštění přístroje	423
4.4 Výběr provozního režimu	423
4.5 Nasávání nebo dávkování kapaliny	423
4.6 Změna rychlosti pipetování	423
4.7 Nastavení otáček motoru	424
4.8 Uložení přístroje	424
5 Pipetování	426
6 Čištění	428
6.1 Kontrola těsnosti	428
6.2 Výměna filtru a čištění adaptéru	428
6.3 UV dezinfekce	431
7 Porucha - co dělat?	432
8 Technické údaje	433
8.1 Označení na výrobku	433

9	Oprava	434
9.1	Zaslání k opravě	434
10	Informace pro objednání	436
10.1	Přístroj	436
10.2	Náhradní díly	436
11	Odpovědnost za vady	438
12	Likvidace	439

1 Úvod

1.1 Rozsah dodávky

Pipetovací pomůcka, nikl-metalhydridový akumulátor, volitelný napájecí zdroj (všimněte si různých objednacích čísel), 2 náhradní membránové filtry 0,2 µm, nástěnný držák, návod k použití

1.2 Návod k použití



- Před prvním použitím si pečlivě přečtěte návod k použití.
- Návod k použití je součástí přístroje a musí být snadno přístupný.
- Pokud přístroj předáváte třetí osobě, přiložte k němu návod k použití.

1.2.1 Úrovně ohrožení

Následující signální slova označují možná ohrožení:

Signální slovo	Význam
NEBEZPEČÍ	Vede k vážnému zranění nebo smrti.
VÝSTRAHA	Může vést k vážnému zranění nebo smrti.
POZOR	Může vést k lehkým nebo středně těžkým zraněním.
UPOZORNĚNÍ	Může vést ke škodám na majetku.

1.2.2 Symboly návodu k použití

Symbol	Význam	Symbol	Význam
	Nebezpečné místo		Nebezpečí výbuchu

Symbol	Význam	Symbol	Význam
	Používejte ochranu očí		Používejte ochranné rukavice

1.2.3 Zobrazení

Zobrazení	Význam	Zobrazení	Význam
1. Úkol	Označuje úkol.	>	Označuje předpoklad.
a., b., c.	Označuje jednotlivé kroky úkolu.	⇒	Označuje výsledek.

2 Bezpečnost

Pozorně si přečtěte!

Laboratorní přístroj accu-jet® S lze použít v kombinaci s nebezpečnými materiály, pracovními postupy a aparaturami. V návodu k použití však nelze uvést všechny bezpečnostní problémy, které mohou nastat. Uživatel je povinen zajistit dodržování zdravotních a bezpečnostních předpisů a před použitím stanovit příslušná omezení.

1. Každý uživatel si musí před použitím přístroje přečíst tento návod k použití a dodržovat jej.
2. Dodržujte obecná upozornění na nebezpečí a bezpečnostní pokyny, např. noste ochranný oděv, ochranu očí a ochranné rukavice.
3. Postupujte podle pokynů výrobce činidla.
4. Nepoužívejte přístroj ve výbušném prostředí a nepipetujte vysoce hořlavá média.
5. Používejte přístroj pouze k pipetování kapalin a pouze v rámci definovaných mezí použití. Dodržujte výjimky z použití, viz Vyloučení použití, p. 416 ! V případě pochybností se bezpodmínečně obraťte na výrobce nebo prodejce.
6. Vždy pracujte tak, aby nebyl ohrožen uživatel ani jiné osoby. Zamezte rozstříku. Používejte pouze vhodné nádoby.
7. Nikdy nepoužívejte sílu.
8. Používejte pouze originální příslušenství a náhradní díly. Neprovádějte žádné technické úpravy. Přístroj nerozebírejte dále, než je popsáno v návodu k použití!
9. Před použitím vždy zkontrolujte správný stav přístroje. Pokud zjistíte jakoukoli poruchu přístroje, okamžitě přestaňte pipetovat a postupujte podle pokynů v kapitole Porucha – co dělat?. V případě potřeby se obraťte na výrobce.
10. K nabíjení nikl-metalhydridového akumulátoru se smí použít pouze originální napájecí zdroj.
11. Akumulátor se nesmí nahrazovat akumulátory jiných výrobců.

12. Napájecí zdroj musí být chráněn před vlhkostí a smí se používat pouze ve spojení s tímto přístrojem.
13. Napájecí zdroj nepoužívejte, pokud je poškozený připojovací kabel.
14. Opravy a zásahy do přístroje smí provádět pouze autorizovaní servisní technici.

2.1 Funkce

Přístroj slouží jako pomůcka pro pipetování kapalin pomocí odměrných a nedělených pipet ze skla nebo plastu s objemem od 0,1 ml do 200 ml a s vnějším průměrem sací trubice < 9,2 mm. Při správné manipulaci přichází pipetovaná kapalina do kontaktu pouze s pipetou.

2.2 Meze použití

Přístroj slouží k pipetování kapalin v rámci následujících fyzikálních mezí:

- od +10 °C do +40 °C (od 50 °F do 104 °F) (přístroj a činidlo)
- Tlak par až do max. 500 mbar. Nad 300 mbar nasávejte pomalu, aby nedošlo k varu kapaliny.
- Hustota do 9 g/cm³

2.3 Vyloučení použití

Přístroj se nesmí používat pro kapaliny, jejichž výpary mají korozivní účinky nebo narušují materiály silikon nebo EPDM.

Přístroj není vhodný pro použití s Pasteurovými pipetami.

▲ VAROVÁNÍ**Provoz přístroje v prostředí s nebezpečím výbuchu**

Přístroj se nesmí provozovat nebo nabíjet ve výbušném prostředí. Nesmí se pipetovat vysoce hořlavá média (bod vzplanutí pod 0 °C (32 °F), např. éter, aceton).

2.4 Podmínky skladování

Přístroj a příslušenství skladujte na chladném a suchém místě pouze po vyčištění.

Skladovací teplota: od -20 °C do + 50 °C (od -4 °F do 122 °F).

Relativní vlhkost vzduchu: 5 % až 95 %.

3 Funkční a ovládací prvky

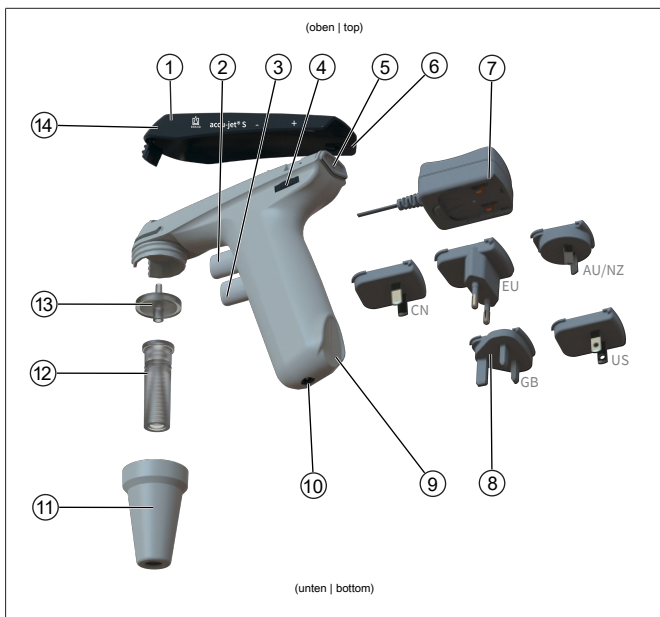

- | | |
|---|--|
| 1 Horní skořepina krytu | 2 Horní pipetovací tlačítko (nasávání kapaliny) |
| 3 Dolní pipetovací tlačítko (dávkování kapaliny) | 4 Nastavovací kolečko pro otáčky motoru |
| 5 Přepínač provozního režimu | 6 Odstavná plocha horní skořepiny krytu |
| 7 Napájecí zdroj | 8 Adaptér pro danou zemi |
| 9 Odstavná plocha rukojeť | 10 Nabíjecí zásuvka |
| 11 Adaptérové pouzdro (PP) | 12 Adaptér/zpětný ventil (SI/PTFE) |
| 13 Membránový filtr (PP/PTFE) | 14 Otvor vyrovnávání tlaku |

Informace o napětí a spotřebě proudu viz Technické údaje, p. 433 .

Zkratka	Materiál
PP	Polypropylen
PTFE	Polytetrafluorethylen
SI	Silikon

4 Uvedení do provozu

4.1 Připojení akumulátoru

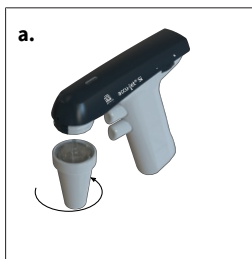

- a.** Odšroubujte adaptérové pouzdro. Adaptér a filtr zůstávají v adaptérovém pouzdru.

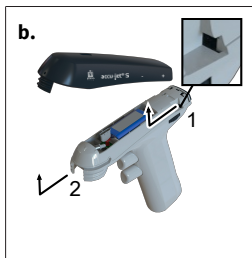

- b.** Sejměte pouzdro. Posuňte pouzdro lehce směrem ke šroubení adaptérového pouzdra.
- ⇒ Pouzdro se uvolní z vybrání nad nastavovacím kolečkem (1) a ze šroubení adaptérového pouzdra (2).
- ⇒ Bude vidět přihrádka na akumulátor.

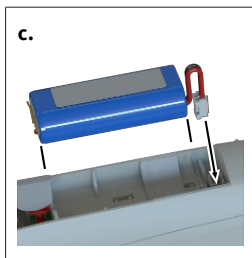

- c.** Držte zástrčku akumulátoru za kabel, odpovídajícím způsobem ji vyrovnajte a pevně ji zasuňte do zásuvky, dokud nezazní slyšitelné cvaknutí. Vložte akumulátor.

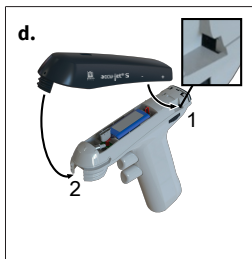

- d.** Vsaďte pouzdro. Dbejte na to, aby pouzdro zapadlo do vybrání nad nastavovacím kolečkem (1) a do šroubení adaptérového pouzdra (2).

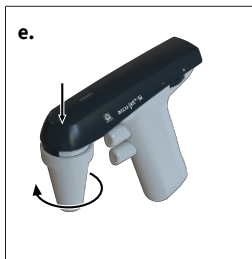

- e.** Zatlačte horní část pouzdra do skořepiny pouzdra a našroubujte adaptérové pouzdro.

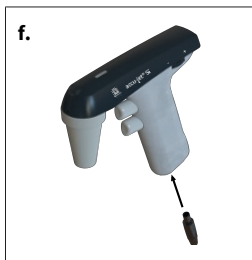

- f.** Nabíjejte akumulátor, dokud LED indikátor nabíjení nezačne blikat zeleně. Doba nabíjení cca 4 hodiny, viz Nabíjení akumulátoru.

4.2 Nabíjení akumulátoru

⚠ VAROVÁNÍ



Poškozený napájecí zdroj nebo nabíjecí kabel

Nebezpečí úrazu elektrickým proudem.



- > Nepoužívejte poškozený napájecí zdroj.
- > Pokud je nabíjecí kabel poškozený, nepoužívejte napájecí zdroj.

POZNÁMKA

Používejte pouze originální napájecí zdroj výrobce!

Použití jiného napájecího zdroje může poškodit přístroj a akumulátor.

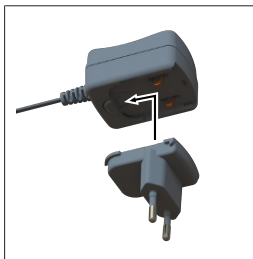

- a. Připojte adaptér pro danou zemi k napájecímu zdroji.
 - b. Připojte napájecí zdroj k přístroji.
 - c. Zapojte napájecí zdroj do sítové zástrčky.
- ⇒ Přístroj se nabíjí. To je patrné z LED indikátoru nabíjení na horní části pouzdra. Provozní doba a doba nabíjení viz Technické údaje, p. 433 .

LED indikátor nabíjení	Stav	Co dělat?
Zelená: bliká	Akumulátor je nabitý. Probíhá udržovací dobíjení.	S přístrojem můžete pracovat. Přístroj je plně nabitý.
Zelená: trvale svítí	Akumulátor se nabíjí	Během nabíjení můžete pokračovat v práci.
Červená: bliká	Akumulátor je téměř vybitý.	Přerušete práce s přístrojem. Nabijte akumulátor. Během nabíjení můžete pokračovat v práci.
Červená: trvale svítí	Akumulátor je vybitý.	Nabijte akumulátor.

- Udržovací dobíjení zabraňuje přebíjení a minimalizuje efekt líné baterie. Abyste zachovali maximální kapacitu, nedobíjejte akumulátor, dokud to nezobrazí LED indikátor nabíjení.

4.3 Spuštění přístroje

Přístroj je připraven k provozu po vložení nabitého akumulátoru. Není zde žádný vypínač.

4.4 Výběr provozního režimu

Přepínač viz Funkční a ovládací prvky, p. 418 .

Provozní režim „Volný odtok“: posuňte přepínač nahoru.

Provozní režim „Vyfukování s podporou motoru“: posuňte přepínač dolů.

4.5 Nasávání nebo dávkování kapaliny

Pipetovací tlačítko viz Funkční a ovládací prvky, p. 418

Stisknutím horního pipetovacího tlačítka pipetu naplníte a dolním pipetovacím tlačítkem dávkujete.

4.6 Změna rychlosti pipetování

Rychlost se omezuje nastavenými maximálními otáčkami motoru. Čím více je horní nebo dolní pipetovací tlačítko stisknuto, tím rychleji se kapalina nasává nebo dávkuje.

4.7 Nastavení otáček motoru

Nastavovací kolečko viz Funkční a ovládací prvky, p. 418

Otáčky motoru lze plynule nastavit od maxima (+) do minima (-) otáčením nastavovacího kolečka. U velkoobjemových pipet doporučujeme maximální otáčky motoru a u maloobjemových pipet nižší otáčky motoru.

4.8 Uložení přístroje

4.8.1 Odstavení na stůl

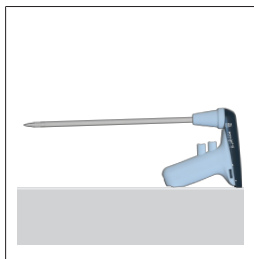

accu-jet® S lze odstavit na rovný povrch s vloženou pipetou.

4.8.2 Nástěnný držák



- a. Montážní plochu očistěte vhodným čisticím prostředkem (ne odmašťujícími čisticími prostředky pro domácnost) a hadříkem, který nepouští vlákna, a nechte ji důkladně vyschnout.
- b. Odstraňte ochrannou fólii z lepicího proužku
- c. **Pevně** přitlačte nástěnný držák k montážnímu povrchu.

5 Pipetování

1. Nasazení pipety

VAROVÁNÍ



Ujistěte se, že je pipeta pevně usazená. Nikdy nepoužívejte sílu! Hrozí nebezpečí rozbití skla, zejména u tenkých pipet! Nebezpečí zranění!

1.



- a. Vždy držte pipetu co nejbližší hornímu konci a opatrně ji zasunujte do adaptéru, dokud není pevně usazená.
- b. Přístroj držte vždy s vloženou pipetou svisle, špičkou dolů.

2. Naplnění pipety

2.

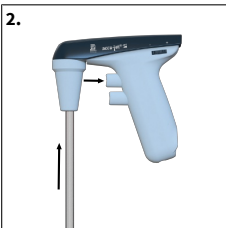

- a. Ponořte špičku pipety do kapaliny.
- b. Pomalu stiskněte horní pipetovací tlačítko a naplňte pipetu tak, aby byl meniskus mírně nad požadovanými značkami.
- c. Pokud stisknete obě pipetovací tlačítka, můžete velmi citlivě nasát nebo dávkovat kapalinu. To je užitečné zejména při nastavování menisku nebo při použití pipet s malými objemy.

Pipetu nepřepĺnujte.

3. Nastavení objemu

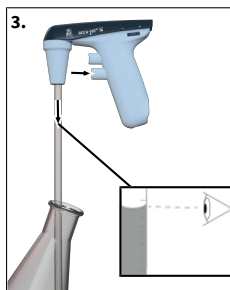

- a.** V případě potřeby otřete špičku pipety vhodným hadříkem, který nepouští vlákna.
- b.** Pomalu zatlačte na dolní pipetovací tlačítko a uvolňujte kapalinu, dokud se meniskus nenastaví přesně na požadovanou značku.

4. Vyprázdnění pipety

- a.** Pomalu stiskněte dolní pipetovací tlačítko. Rychlost pipetování závisí na tom, jak hluboko jsou stisknuta pipetovací tlačítka. V provozním režimu „Vyfukování s podporou motoru“ závisí také na nastavených otáčkách motoru.

5. Po pipetování

- a.** Uchopte pipetu co nejvíce nahoře a vytáhněte ji z adaptéru.

6 Čištění

POZNÁMKA

accu-jet® S nelze autoklárovat

Části pouzdra občas otřete vlhkým hadříkem. Při správném používání je přístroj bezúdržbový.

6.1 Kontrola těsnosti

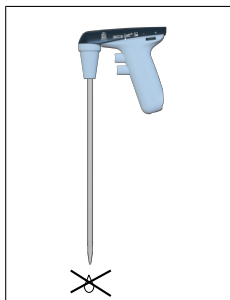

Po nastavení menisku nesmí z pipety odkapávat žádná kapalina, aniž by došlo k aktivaci ventilů. Pokud pipeta kape, viz část Porucha - co dělat?

6.2 Výměna filtru a čištění adaptéru

⚠ VAROVÁNÍ



Nebezpečí kontaminace a infekce

Používejte ochranné rukavice a ochranu očí.



POZNÁMKA

Výměna nebo čištění filtru jsou potřeba pouze v případě, že došlo k přeplnění pipety nebo ke zhoršení sacího výkonu.

b.



- a.** Vytáhněte pipetu.
- b.** Odšroubujte adaptérové pouzdro.
- c.** Sejměte horní pouzdro.

d.



- d.** Vytlačte adaptér a membránový filtr z kuželové strany adaptérového pouzdra.

e.



- e.** Stáhněte vadný membránový filtr.

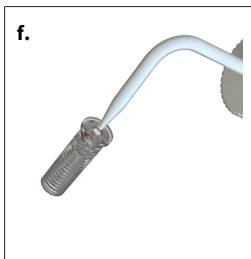

- f.** Při čištění adaptér opatrně opláchněte rozprašovačem naplněným vhodnou čisticí kapalinou, např. vodou. Poté vyfoukejte a osušte.

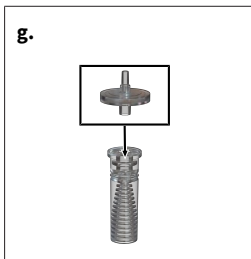

- g.** Nový membránový filtr zatlačte do adaptéru nejprve silnějším spojem směrem dolů (tenčí, kuželovitou stranou nahoru) a vložte jej do adaptérového pouzdra.

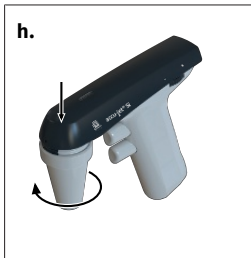

- h.** Zatlačte horní část pouzdra do skořepiny pouzdra a našroubujte adaptérové pouzdro.

Upozornění k autoklávovatelným filtrům

Účinnost autoklávování musí v každém případě zkontrolovat uživatel. Ne každý membránový filtr je vhodný! Používejte pouze originální příslušenství.

- > Přístroj je standardně vybavený membránovým filtrem 0,2 μm (červený barevný kód).
 - > Membránový filtr lze až pětkrát autoklávovat při teplotě 121 °C (250 °F).
 - > S 0,2 μm membránovým filtrem (pro buněčné kultury) lze dosáhnout objemové tolerance třídy B.
 - > Pro dodržení objemových tolerancí třídy A jsou nutné membránové filtry 3 μm . Ty mají menší vliv na dobu volného průtoku pipet díky větší velikosti pórů, viz .
-

6.3 UV dezinfekce

Přístroj je odolný vůči běžnému působení UV dezinfekční lampy. V důsledku působení UV záření může dojít ke změně barvy.

7 Porucha - co dělat?





Porucha	Příčina	Co dělat?
Oslabený sací výkon	Otáčky motoru jsou snižené	Zvyšte otáčky motoru, viz Nastavení otáček motoru, p. 424 .
	Zpětný ventil zavřený	Nastavte přepínač na vyfukování a stiskněte dolní tlačítko pipetování, viz Výběr provozního režimu, p. 423
Pipeta kape	Filtr není správně usazený	Vsadte správně filtr, viz Výměna filtru a čištění adaptéru, p. 428 .
	Poškozený adaptér nebo pipeta	Vyměňte adaptér nebo pipetu, viz Výměna filtru a čištění adaptéru, p. 428 .
Pipeta nedrží v adaptéru	Adaptér je znečištěný nebo poškozený	Adaptér vyčistěte, vysušte a v případě potřeby vyměňte, viz Výměna filtru a čištění adaptéru, p. 428 .
LED indikátor nabíjení nesvíí/nebliká po připojení napájecího zdroje a vytvoření napájení.	Zástrčka akumulátoru není pevně zasunutá	Pevně zasuňte zástrčku akumulátoru, viz Připojení akumulátoru, p. 420 .
	Nesprávný napájecí zdroj	Používejte pouze originální napájecí zdroj, viz Funkční a ovládací prvky, p. 418
	Vadný akumulátor nebo napájecí zdroj	Vyměňte akumulátor/napájecí zdroj
	Vadný přístroj	Odešlete přístroj do opravy, viz Oprava, p. 434
Nízká kapacita akumulátoru	Vadný akumulátor	Vyměňte akumulátor, viz Připojení akumulátoru, p. 420 .
Přístroj nevykazuje žádnou funkci	Interní chyba (provedte reset)	Odpojte zástrčku akumulátoru a podržte pipetovací tlačítko po dobu 10 sekund. Poté znovu pevně zasuňte zástrčku akumulátoru, viz Připojení akumulátoru, p. 420 a Pipetování, p. 426

Pokud se vám nepodaří problém vyřešit pomocí výše uvedené tabulky poruch, obraťte se na svého prodejce nebo přímo na výrobce.

8 Technické údaje

Technické údaje	Hodnoty
Nabíjecí zásuvka	5 VDC
Napájecí zdroj	Vstup: 100 – 240 VAC, 50/60 Hz Výstup: 5 VDC
Akumulátor	Akumulátorový blok NiMH 2,4 V, 730 mAh Doba nabíjení: 4 h Maximální doba provozu: cca 8 h Nabíjecí teplota: +10 °C až +35 °C

8.1 Označení na výrobku

Značka nebo číslo	Význam
XXZXXXXX	Sériové číslo
Quick Response Code	Obsahuje sériové číslo
	Touto značkou potvrzujeme, že výrobek splňuje požadavky stanovené ve směrniciích ES a byl podroben stanoveným zkušebními postupům.
	UKCA: United Kingdom Conformity Assessed Tato značka potvrzuje, že výrobek splňuje požadavky stanovené normami UK Designated Standards.
www.brand.de/ip	Patentové informace
 (zde: 40 let)	Čína RoHS (EFUP) EFUP definuje dobu v letech, po kterou nebezpečné látky obsažené v elektrických a elektronických přístrojích za běžných provozních podmínek neunikají ani se nemění. Při běžném používání uživatelem tyto elektrické a elektronické výrobky nezpůsobí vážné znečištění životního prostředí, vážné fyzické zranění nebo poškození majetku uživatele.
	Elektrický spotřebič se nesmí likvidovat společně s domovním odpadem.

9 Oprava

9.1 Zaslání k opravě

POZNÁMKA

Přeprava nebezpečných materiálů bez povolení je zákonem zakázána.

Přístroj důkladně vyčistěte a dekontaminujte!

- Při zpětném zasílání výrobků vždy uveďte přesný popis typu poruchy a použitého média. Pokud nejsou uvedena použitá média, nelze přístroj opravit.
- Přístroj zasílejte výhradně bez akumulátoru.
- Zpětná přeprava se děje na nebezpečí a náklady odesílatele.

Mimo USA a Kanadu

Vyplňte „Prohlášení o zdravotní nezávadnosti“ a zašlete je spolu s přístrojem výrobcí nebo prodejci. Formuláře si můžete vyžádat u prodejce nebo výrobce nebo jsou k dispozici ke stažení na adrese www.brand.de.

V USA a Kanadě

Před odesláním přístroje do servisu se informujte u společnosti BrandTech Scientific, Inc. o požadavcích na vrácení.

Na adresu uvedenou u čísla pro zpětné zaslání zašlete pouze vyčištěné a dekontaminované přístroje. Na vnější stranu obalu nalepte číslo pro zpětné zaslání tak, aby bylo dobře viditelné.

Kontaktní adresy

Německo:

BRAND GMBH + CO KG
Otto-Schott-Straße 25
97877 Wertheim (Německo)
T +49 9342 808 0
F +49 9342 808 98000
info@brand.de
www.brand.de

USA a Kanada:

BrandTech® Scientific, Inc.
11 Bokum Road
Essex, CT 06426-1506 (USA)
T +1-860-767 2562
F +1-860-767 2563
info@brandtech.com
www.brandtech.com

Indie:

BRAND Scientific Equipment Pvt. Ltd.
303, 3rd Floor, 'C' Wing, Delphi
Hiranandani Business Park,
Powai
Mumbai-400 076 (Indie)
T +91 22 42957790
F +91 22 42957791
info@brand.co.in
www.brand.co.in

Čína:

BRAND (Shanghai) Trading Co., Ltd.
Guangqi Culture Plaza
Room 506, Building B
No. 2899, Xietu Road
Shanghai 200030 (P.R. Čína)
T +86 21 6422 2318
F +86 21 6422 2268
info@brand.com.cn
www.brand.cn.com

10 Informace pro objednání

10.1 Příklad

Barva horní části pouzdra	Obj. č. (s univerzálním napájecím zdrojem a adaptérem pro danou zemi)	Obj. č. (bez univerzálního napájecího zdroje a bez adaptéru pro danou zemi)
Antracit	26350	26360
Beere	26351	26361
Petrolej	26352	26362
Ametyst	26353	26363

Rozsah dodávky viz . Povšimněte si objednacích čísel, s napájecím zdrojem nebo bez něj.

10.2 Náhradní díly

Náhradní membránový filtr

Popis	Obal. j.	Obj. č.
0,2 µm, sterilní (červený barevný kód)	1 ks v blistru	26530
0,2 µm	10 ks v PE sáčku	26535
3 µm	1 ks v blistru	26052
3 µm	10 ks v PE sáčku	26056

Napájecí zdroj

Technické údaje napájecího zdroje viz Technické údaje, p. 433 .

Typ	Obj. č.
Napájecí zdroj s adaptérem pro danou zemi	26606

Akumulátorový blok

Technické údaje akumulátoru viz Technické údaje, p. 433 .

Popis	Obj. č.
Akumulátorový blok NiMH	26630

Silikonový adaptér se zpětným ventilem

Popis	Obj. č.
Silikonový adaptér	26508

Adaptérové pouzdro

Barva	Obj. č.
bílá	26658

Nástěnný držák

Barva	Obj. č.
bílá	26539

Lepicí páska

Obal. j.	Obj. č.
3 sady	26547

11 Odpovědnost za vady

Neodpovídáme za následky nesprávné manipulace, používání, údržby, provozu nebo neautorizované opravy přístroje ani za následky běžného opotřebení, zejména opotřebitelných dílů, jako jsou písty, těsnění, ventily a rozbité sklo. Totéž platí pro nedodržení návodu k použití. Zejména nepřebíráme žádnou odpovědnost za škody vzniklé tím, že byl přístroj rozebrán více, než je popsáno v návodu k použití, nebo pokud bylo instalováno příslušenství nebo náhradní díly třetích stran.

USA a Kanada:

Informace o odpovědnosti za vady naleznete na adrese www.brandtech.com.

12 Likvidace



Protěží symbol znamená, že baterie/akumulátory a elektronické přístroje musí být po skončení své životnosti likvidovány odděleně od domovního odpadu (netříděného komunálního odpadu).

Elektronické přístroje musí být řádně zlikvidovány v souladu se směrnicí Evropského parlamentu a Rady 2012/19/EU ze dne 4. července 2012 o odpadních elektrických a elektronických přístrojích v souladu s vnitrostátními předpisy o likvidaci odpadů.

Baterie a akumulátory obsahují látky, které mohou mít škodlivý vliv na životní prostředí a lidské zdraví. Proto musí být řádně zlikvidovány podle směrnice Evropského parlamentu a Rady 2006/66/ES ze dne 6. září 2006 o bateriích a akumulátorech v souladu s vnitrostátními předpisy o likvidaci odpadů. Likvidujte pouze zcela vybité baterie a akumulátory.

EU-Konformitätserklärung | EU Declaration of Conformity

Produktbezeichnung: Product name:	Pipettierhelfer accu-jet® S / Pipetting controller accu-jet® S
Produktvarianten: Product variations:	Anthrazit, Beere, Petrol, Amethyst / anthracite, berry, petrol, amethyst
Art-Nr. / Cat.-No.	26350, 26351, 26352, 26353, 26360, 26361, 26362, 26363

Das oben beschriebene Produkt entspricht den grundlegenden Anforderungen, die in den nachfolgend bezeichneten Harmonisierungsrechtsvorschriften festgelegt sind: The product described above meets the basic requirements that are specified in the harmonization legislation listed below:	Angewendete harmonisierte Normen: Applied harmonized standards:
RoHS: 2011/65/EU incl.2015/863/EU EMC: 2014/30/EU	EN IEC 63000:2018 EN 61326-1:2013
Weitere angewendete Normen: Other applied standards:	Geltungsbereich: Scope:
EN 61010-1:2010, EN 61010-1:2010/A1:2019/AC:2019-04 EN/IEC 62368-1:2014 (angewendet auf Fremdherstellernetzteil / applied to third-party power supply)	NRL / LVD NRL / LVD

Die alleinige Verantwortung für die Ausstellung dieser Konformitätserklärung in Bezug auf die Erfüllung der grundlegenden Anforderungen und die Anfertigung der technischen Unterlagen trägt der Hersteller.

The manufacturer is solely responsible for issuing this declaration of conformity with regard to meeting the essential requirements and preparing the technical documentation.

Hersteller / Manufacturer	Adresse / Address
BRAND GMBH + CO KG	Otto-Schott-Str. 25 97877 Wertheim Germany

Wertheim, 01. Juli 2022 / 01 July 2022



Patrick Ziemeck
Managing Director Technology



i.A. Siegfried Ott
Regulatory Affairs

Diese Erklärung bescheinigt die Übereinstimmung mit den genannten Harmonisierungsvorschriften, beinhaltet jedoch keine Zusicherung von Eigenschaften.

This document declares the accordance with the named harmonized regulations, but does not assure specific properties.

UK Declaration of Conformity

Product name: Pipetting controller accu-jet® S
Product variations: anthracite, berry, petrol, amethyst
Cat.-No. 26350, 26351, 26352, 26353, 26360, 26361, 26362, 26363

The product described above meets the basic requirements that are specified in the harmonization legislation listed below:	Applied harmonized standards:
The Restriction of the Use of Certain Hazardous Substances in Electrical and Electronic Equipment Regulations 2012 (SI 2012 No. 3032)	EN IEC 63000:2018
Electromagnetic Compatibility Regulations 2016 (SI 2016 No. 1091, as amended by SI 2019 No. 696)	EN 61326-1:2013
Other applied standards:	Scope:
EN 61010-1:2010, EN 61010-1:2010/A1:2019/AC:2019-04 EN/IEC 62368-1:2014 (angewendet auf Fremdherstellernetzteil / applied to third-party power supply)	LVD LVD

The manufacturer is solely responsible for issuing this declaration of conformity with regard to meeting the essential requirements and preparing the technical documentation.

Manufacturer	Address
BRAND GMBH + CO KG	Otto-Schott-Str. 25 97877 Wertheim Germany

Wertheim, 18 February 2022



Patrick Ziemeck
Managing Director Technology



i.A. Siegfried Ott
Regulatory Affairs

This document declares the accordance with the named harmonized regulations, but does not assure specific properties.

Declaration of conformity – China RoHS 2

BRAND GMBH + CO KG has made reasonable efforts to ensure that hazardous materials and substances may not be used in BRAND products.

In order to determine the concentration of hazardous substances in all homogeneous materials of the subassemblies, a “Product Conformity Assessment” (PCA) procedure was performed. As defined in GB/T 26572 the “Maximum Concentration Value” limits (MCV) apply to these restricted substances:

+ Lead (Pb):	0.1%	+ Hexavalent chromium (Cr(+VI)):	0.1%
+ Mercury (Hg):	0.1%	+ Polybrominated biphenyls (PBB):	0.1%
+ Cadmium (Cd):	0.01%	+ Polybrominated diphenyl ether (PBDE):	0.1%

Environmental Friendly Use Period (EFUP)

EFUP defines the period in years during which the hazardous substances contained in electrical and electronic products will not leak or mutate under normal operating conditions. During normal use by the user such electrical and electronic products will not result in serious environmental pollution, cause serious bodily injury or damage to the user's assets.

The Environmental Friendly Use Period for BRAND instruments is 40 years.



Material Content Declaration for BRAND Products

部件名称 Part name	有毒有害物质或元素 Hazardous substances					
	铅 Pb	汞 Hg	镉 Cd	六价铬 Cr(+VI)	多溴联苯 PBB	多溴二苯醚 PBDE
包装 / Packaging	0	0	0	0	0	0
塑料外壳 / 组件 Plastic housing / parts	0	0	0	0	0	0
电池 / Battery	0	0	0	0	0	0
玻璃 / Glass	0	0	0	0	0	0
电子电气组件 Electrical and electronic parts	X	0	0	0	0	0
金属外壳 / 组件 Metal housing / parts	X	0	0	0	0	0
电机 / Motor	X	0	0	0	0	0
配件 / Accessories	X	0	0	0	0	0
此表格是按照SJ/T 11364-2014中规定所制定的。 This table is created according to SJ/T 11364-2014.						

- O: 表示该有毒有害物质在该部件所有均质材料中的含量均在GB/T 26572规定的限量要求以下。
O: Indicates that the above mentioned hazardous substance contained in all homogeneous materials of the part is below the required limit as defined in GB/T 26572.
- X: 表示该有毒有害物质至少在该部件某一均质材料中的含量超出GB/T 26572规定的限量要求。
X: Indicates that the above mentioned hazardous substance contained in at least one of the homogeneous materials of this part is above the required limit as defined in GB/T 26572.

注释： 电池，玻璃制品和配件可能不属于此设备的一部分且/或可能有它自己的EFUP标志且/或可能包含更改EFUP标志的部件。

Note: Batteries, glassware and accessories might not be content of the enclosed device and/or may have their own EFUP-marking and/or might be maintaining parts with changing EFUP-marking.

除上表所示信息外，还需声明的是，这些部件并非是有用铅 (Pb), 汞 (Hg), 镉 (Cd), 六价铬 (Cr(+VI)), 多溴联苯 (PBB) 或多溴二苯醚 (PBDE) 来制造的。

Apart from the disclosures in the above table, the subassemblies are not intentionally manufactured or formulated with lead (Pb), mercury (Hg), cadmium (Cd), hexavalent chromium (Cr+VI), polybrominated biphenyls (PBB), and polybrominated diphenyl ethers (PBDE).

Products manufactured by BRAND may enter into further devices or can be used together with other appliances. With these third party products and appliances in particular, please note the EFUP labeled on these products. BRAND will not take responsibility for the EFUP of those products and appliances.

Place, date: Wertheim, 05|04|2022



Patrick Ziemeck
(Managing Director Technology)



i.A. Siegfried Ott
(Regulatory Affairs)

Inhoudsopgave

1	Introductie.....	446
1.1	Leveringsomvang.....	446
1.2	Voorwaarde voor het gebruik.....	446
2	Veiligheid.....	448
2.1	Functie.....	449
2.2	Toepassingsgrenzen.....	449
2.3	Uitgesloten toepassingen.....	450
2.4	Voorwaarden voor opslag.....	450
3	Functie- en bedieningselementen	451
4	Ingebruikname.....	453
4.1	Accu aansluiten	453
4.2	Accu opladen.....	455
4.3	Het apparaat starten.....	456
4.4	Modus selecteren	456
4.5	Vloeistof opzuigen of afgeven	456
4.6	Pipetteersnelheid wijzigen	457
4.7	Het motortoerental instellen.....	457
4.8	Het apparaat bewaren	457
5	Pipetteren	459
6	Reiniging	461
6.1	Op lekkage controleren	461
6.2	Het filter vervangen en de adapter reinigen	462
6.3	UV-ontkieming	464
7	Storing - wat te doen?	465
8	Technische gegevens	466
8.1	Aanduiding op het product.....	466
9	Reparatie.....	467
9.1	Opsturen ter reparatie	467

10 Bestelinformatie	469
10.1 Apparaat	469
10.2 Reserveonderdelen	469
11 Aansprakelijkheid bij gebreken.....	471
12 Afvalverwerking	472

1 Introductie

1.1 Leveringsomvang

Pipetteerhulp, nikkelmetaalhybride accu, netadapter als optie (rekening houden met verschillende bestelnummers), 2 extra membraanfilters 0,2 µm, wandhouder, gebruiksaanwijzing

1.2 Voorwaarde voor het gebruik





- Lees de gebruiksaanwijzing zorgvuldig door voordat u de pipetteerhulp voor het eerst gaat gebruiken.
- De gebruiksaanwijzing is onderdeel van het apparaat en moet op een gemakkelijk toegankelijke plaats worden bewaard.
- Voeg de gebruiksaanwijzing bij het apparaat wanneer u het doorgeeft aan derden.

1.2.1 Gevarenniveaus

De onderstaande signaalwoorden duiden op mogelijke gevaren:

Signaalwoord	Betekenis
GEVAAR	Leidt tot zeer ernstig of fataal letsel.
WAARSCHUWING	Kan tot zeer ernstig of fataal letsel leiden.
VOORZICHTIG	Kan tot licht of middelzwaar letsel leiden.
OPMERKING	Kan tot materiële schade leiden.

1.2.2 Symbolen in de gebruiksaanwijzing

Symbool	Betekenis	Symbool	Betekenis
	Gevaarlijke plaats		Explosiegevaar
	Oogbescherming dragen		Veiligheidshandschoenen dragen

1.2.3 Weergave

Weergave	Betekenis	Weergave	Betekenis
1. Taak	Duidt op een taak die moet worden uitgevoerd.	>	Duidt op een voorwaarde.
a., b., c.	Duidt op een afzonderlijke stap van de taak.	⇒	Duidt op een resultaat.

2 Veiligheid

Deze absoluut zorgvuldig doorlezen!

Het laboratoriumapparaat accu-jet® S kan in combinatie met gevaarlijke materialen, arbeidsprocessen en apparaten worden gebruikt. De gebruiksaanwijzing kan echter niet alle veiligheidsproblemen bevatten, die daarbij eventueel kunnen optreden. Het behoort tot de verantwoordelijkheid van de gebruiker om alle voorschriften met betrekking tot de veiligheid en gezondheid te respecteren en de betreffende beperkingen ten aanzien van het gebruik te bepalen.

1. Iedere gebruiker moet deze gebruiksaanwijzing vóór gebruik van het apparaat hebben gelezen en in acht nemen.
2. De algemene verwijzingen naar gevaren en de veiligheidsvoorschriften opvolgen, bijv. beschermende kleding, oogbescherming en veiligheidshandschoenen dragen.
3. De opgaven van de fabrikant van de reagens in acht nemen.
4. Het apparaat niet in een explosiegevaarlijke omgeving gebruiken en geen licht ontvlambare media pipetteren.
5. Het apparaat alleen voor het pipetteren van vloeistoffen en alleen in het kader van de gedefinieerde toepassingsgrenzen gebruiken. Uitsluitend toepassingen in acht nemen, zie Uitsluitend toepassingen, pag. 450 ! Bij twijfel absoluut contact opnemen met de fabrikant of leverancier.
6. Altijd zo te werk gaan, dat noch de gebruiker noch andere personen in gevaar worden gebracht. Vermijd spatten. Gebruik uitsluitend geschikte erlenmeyers.
7. Gebruik nooit geweld.
8. Gebruik uitsluitend originele toebehoren en originele reserveonderdelen. Voer geen technische veranderingen uit. Het apparaat niet verder demonteren dan in de gebruiksaanwijzing is beschreven!

9. Controleer voor gebruik altijd of het apparaat nog helemaal in orde is. Indien het apparaat storingen vertoont, onmiddellijk stoppen met pipetteren en het hoofdstuk Störung - Was tun? volgen. Neem, Indien nodig, contact op met de fabrikant.
10. Voor het opladen van de nikkel-metaalhydride-accu mag alleen de originele netadapter worden gebruikt.
11. De accu mag niet worden vervangen door een accu van een andere fabrikant.
12. De netadapter moet tegen vocht worden beschermd en mag alleen in combinatie met dit apparaat worden gebruikt.
13. Gebruik de netadapter niet langer als het snoer beschadigd is.
14. Reparaties en ingrepen in het apparaat mogen alleen door geautoriseerde servicemonteurs worden uitgevoerd.

2.1 Functie

Het apparaat is bedoeld als hulp bij het pipetteren van vloeistoffen in meet- en volledige pipetten van glas of kunststof met een volume van 0,1 ml tot 200 ml en een zuigbuis met een buitendiameter < 9,2 mm. Bij een correct gebruik komt de gepipetteerde vloeistof alleen in contact met de pipet.

2.2 Toepassingsgrenzen

Dit apparaat dient voor het pipetteren van vloeistoffen met inachtneming van de onderstaande natuurkundige grenzen:

- Van +10°C tot +40°C (van 50°F tot 104°F) (apparaat en reagens)
- Dampdruk tot max. 500 mbar. Boven 300 mbar langzaam opzuigen, om te voorkomen dat de vloeistof gaat koken.
- Dichtheid tot 9 g/cm³

2.3 Uitgesloten toepassingen

Het apparaat mag niet worden gebruikt voor vloeistoffen ,waarvan de dampen corroderend werken of de materialen siliconen of EPDM aantasten.

Het apparaat is niet geschikt voor gebruik in combinatie met pasteurpipetten.

WAARSCHUWING



Gebruik van het apparaat in een explosiegevaarlijke omgeving

Het apparaat mag niet in een explosiegevaarlijke omgeving gebruikt of geladen worden. Er mogen geen licht ontvlambare media gepipetteerd worden (vlampunt onder 0°C (32°F) bijv. ether, aceton).

2.4 Voorwaarden voor opslag

Het apparaat en de toebehoren alleen in gereinigde toestand, koel en droog bewaren.

Opslagtemperatuur: van -20°C tot +50°C (van -4°F tot 122 °F).

Relatieve luchtvochtigheid: 5% tot 95%.

3 Functie- en bedieningselementen

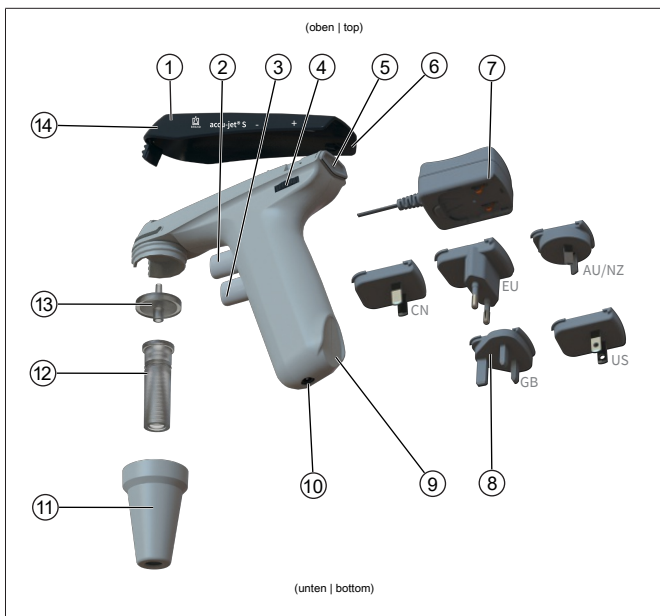

- | | |
|---|--|
| 1 Bovenste schaal van de behuizing | 2 Bovenste pipetteerknop (vloeistof opnemen) |
| 3 Onderste pipetteerknop (vloeistof afgeven) | 4 Stelwielkje voor het motortoerental |
| 5 Keuzeschakelaar voor de modus | 6 Stelvlak voor de bovenste schaal van de behuizing |
| 7 Netadapter | 8 Landenadapter |
| 9 Stelvlak greep | 10 Laadbus |
| 11 Adapterbehuizing (PP) | 12 Adapter/terugslagklep (SI/PTFE) |
| 13 Membraanfilter (PP/PTFE) | 14 Opening voor drukcompensatie |

Zie voor informatie over de spanning en het stroomverbruik onder Technische gegevens, pag. 466 .

3 Functie- en bedieningselementen

Afk.	Materiaal
PP	Polypropyleen
PTFE	Polytetrafluorethyleen
SI	Siliconen

4 Ingebruikname

4.1 Accu aansluiten

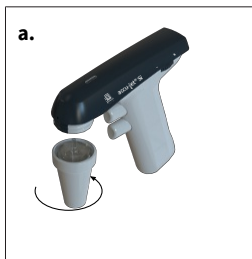

- a.** De adapterbehuizing losschroeven en verwijderen. De adapter en het filter zitten in de adapterbehuizing.

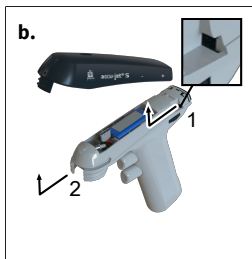

- b.** De behuizing verwijderen. De behuizing iets in de richting van de schroefverbinding van de adapterbehuizing schuiven.

⇒ De behuizing komt los uit de uitsparingen boven het stelwielje (1) en uit de schroefverbinding van de adapterbehuizing (2).

⇒ Het accuvak wordt zichtbaar.

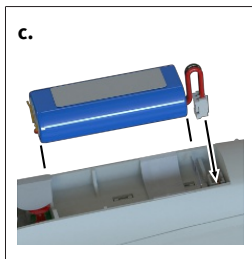

- c.** De stekker van de accu bij de kabel vasthouden, correct uitlijnen en stevig in de bus steken, totdat deze hoorbaar vastklikt. De accu plaatsen.

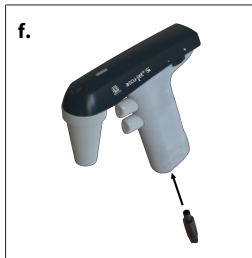
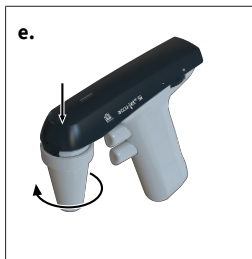
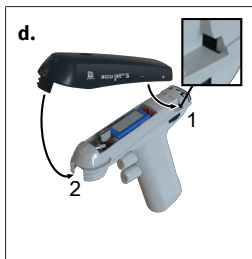

d. De behuizing aanbrengen. Let er daarbij op dat de behuizing in de daarvoor bestemde uitsparingen boven het stelwiel (1) en in de schroefverbinding van de adapterbehuizing (2) valt.

e. Het bovenste deel van de behuizing in de behuizingsschalen drukken en de adapterbehuizing erop schroeven.

f. De accu opladen tot de LED-indicator groen knippert. De oplaadtijd bedraagt ca. 4 uur, zie Accu opladen.

4.2 Accu opladen

⚠ WAARSCHUWING



Beschadigde netadapter of laadkabel

Gevaar voor letsel door een elektrische schok.



- > In geen geval een beschadigde netadapter gebruiken.
- > De netadapter niet gebruiken als de laadkabel beschadigd is.

AANWIJZING

Gebruik uitsluitend originele netadapters van de fabrikant!

Door het gebruik van een andere netadapter kan het apparaat of de accu beschadigd raken.

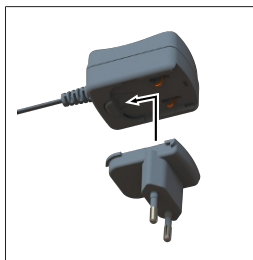

- a. De landenadapter op de netadapter steken.
 - b. De netadapter met het apparaat verbinden.
 - c. De netadapter in de netstekker steken.
- ⇒ Het apparaat wordt opgeladen. Dit is zichtbaar aan de LED-laadindicator op het bovenste deel van de behuizing. Zie voor de bedrijfs- en oplaadduur onder Technische gegevens, pag. 466.

LED-laadindicator	Status	Wat te doen?
Groen: knipperend	De accu is opgeladen. Er vindt een onderhoudslading plaats.	U kunt met het apparaat werken. Het apparaat is volledig opgeladen.
Groen: permanent brandend	De accu wordt opgeladen	U kunt ook tijdens het opladen gewoon doorwerken.
Rood: knipperend	De accu is bijna leeg.	Onderbreek uw werkzaamheden met het apparaat.

LED-laadindicator	Status	Wat te doen?
		Laad de accu op. U kunt ook tijdens het opladen gewoon doorwerken.
Rood: permanent brandend	De accu is helemaal leeg.	Laad de accu op.

AANWIJZING

- De onderhoudslading voorkomt dat de accu te vol wordt geladen en minimaliseert het luie batterij-effect. Om de maximale capaciteit te behouden adviseren wij om de accu pas weer op te laden als dit door de LED-laadindicator wordt aangegeven.

4.3 Het apparaat starten

Het apparaat is gebruiksklaar als een opgeladen accu is geplaatst. Het apparaat heeft geen ON/OFF-schakelaar.

4.4 Modus selecteren

Keuzeschakelaar, zie Functie- en bedieningselementen, pag. 451 .

Modus „Vrij verloop“: de keuzeschakelaar naar boven schuiven.

Modus „Uitblazen met motorondersteuning“: de keuzeschakelaar naar beneden schuiven.

4.5 Vloeistof opzuigen of afgeven

Voor de pipetteerknop zie Functie- en bedieningselementen, pag. 451

Voor het vullen van de pipet op de bovenste pipetteerknop en voor het afgeven op de onderste pipetteerknop drukken.

4.6 Pipetteersnelheid wijzigen

De snelheid wordt begrensd door het ingestelde maximale motortoerental. Hoe verder de bovenste of onderste pipetteerknop wordt ingedrukt, des te sneller wordt de vloeistof opgenomen of afgegeven.

4.7 Het motortoerental instellen

Zie voor het stelwiel onder Functie- en bedieningselementen, pag. 451

Door het stelwiel te verdraaien kan het motortoerental traploos van maximum (+) tot minimum (-) worden ingesteld. Wij adviseren om het maximale toerental voor pipetten met een groot volume en een lager toerental voor pipetten met een geringer volume te gebruiken.

4.8 Het apparaat bewaren

4.8.1 Neerleggen op een tafel

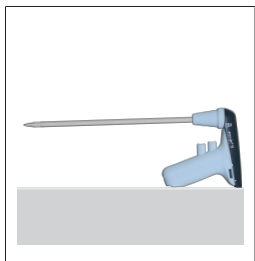

De accu-jet® S kan met een ingestoken pipet op een vlakke ondergrond worden neergelegd.

4.8.2 Wandhouder



- a. Het bevestigingsoppervlak met een geschikt reinigingsmiddel (geen vocht inbrengend huishoudelijk reinigingsmiddel) en een pluisvrije doek reinigen en goed laten drogen.
- b. Het beschermfolie van de plakstrip trekken
- c. De wandhouder **stevig** op het bevestigingsoppervlak drukken.

5 Pipetteren

1. Pipet opsteken

⚠ WAARSCHUWING



Op een correcte plaatsing van de pipet letten. Gebruik nooit geweld! Met name bij dunne pipetten bestaat gevaar voor glasbreuk! Gevaar voor letsel!

1.



- De pipet altijd zo dicht mogelijk bij het bovenste uiteinde vasthouden en voorzichtig in de adapter schuiven, totdat hij goed vastzit.
- Het apparaat met een ingestoken pipet altijd rechtop houden met de punt naar beneden.

2. De pipet vullen

2.

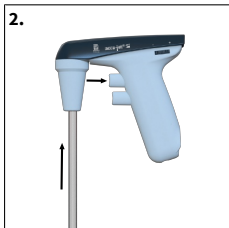

- Dompel de punt van de pipet in de vloeistof.
- De bovenste pipetteerknop langzaam indrukken en de pipet vullen, zodat de meniscus ongeveer over het gewenste merkteken ligt.
- Wanneer op beide pipetteerknoppen wordt gedrukt, kunt u de vloeistof zeer nauwkeurig opnemen en afgeven. Dat komt vooral van pas wanneer u de meniscus instelt of pipetten met een gering volume gebruikt.

AANWIJZING

De pipet niet te vol vullen.

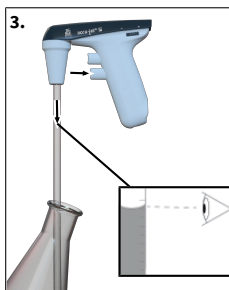
3. Het volume instellen

- a.** De punt van de pipet evt. met een geschikte pluisvrije doek afvegen.
- b.** De onderste pipetteerknop langzaam indrukken en de vloeistof afvoeren tot de meniscus exact op de gewenste markering is ingesteld.

4. De pipet legen

- a.** Druk de onderste pipetteerknop langzaam in. De pipetteersnelheid is afhankelijk van het feit, hoever de pipetteerknoppen worden ingedrukt. In de modus „Uitblazen met motorondersteuning“ is deze tevens afhankelijk van het ingesteld motortoerental.

5. Na het pipetteren

- a.** De pipet bij voorkeur zo ver mogelijk naar boven vastpakken en uit de adapter trekken.

6 Reiniging

AANWIJZING

De accu-jet® S kan niet in de autoclaaf worden gereinigd

De onderdelen van de behuizing zo nu en dan met een vochtige doek afvegen. Bij een correct gebruik volgens de voorschriften is het apparaat onderhoudsvrij.

6.1 Op lekkage controleren

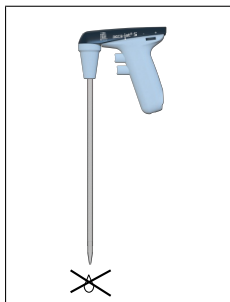

Na het instellen van de meniscus mag zonder bediening van de ventielen geen vloeistof uit de pipet lekken. Als de pipet lekt, zie dan onder Storing - wat te doen?

6.2 Het filter vervangen en de adapter reinigen

⚠ WAARSCHUWING



Gevaar voor contaminatie en infecties

Veiligheidshandschoenen en oogbescherming dragen.



AANWIJZING

Het filter moet vervangen of gereinigd worden als een pipet met teveel vloeistof werd gevuld of het zuigvermogen onvoldoende is.

b.



- a.** De pipet verwijderen.
- b.** De adapterbehuizing losschroeven en verwijderen.
- c.** De bovenste behuizing verwijderen.

d.



- d.** De adapter en het membraanfilter aan de taps toelopende zijde van de adapterbehuizing naar buiten drukken.

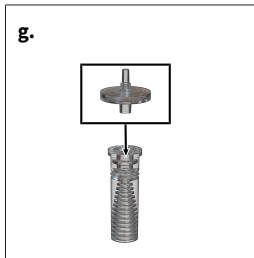
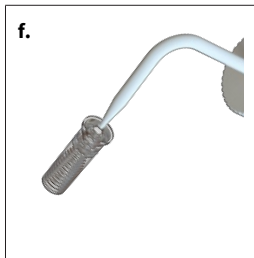
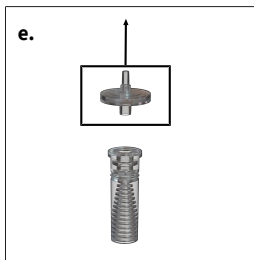

e. Het defecte membraanfilter verwijderen.

f. De adapter bij het reinigen zorgvuldig met behulp van een spuitfles uitspoelen, die met een geschikte reinigingsvloeistof, bijv. water, is gevuld. Aansluitend uitblazen en drogen.

g. Eerst een nieuw membraanfilter met de dickere aansluiting naar onderen in de adapter drukken (de dunnere, conische zijde wijst naar boven) en in de adapterbehuizing plaatsen.

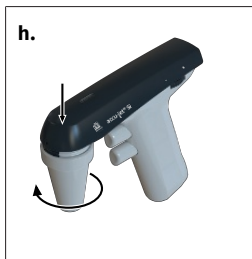

- h.** Het bovenste deel van de behuizing in de behuizingsschalen drukken en de adapterbehuizing erop schroeven.

AANWIJZING

Aanwijzing voor filters die in de autoclaaf gedesinfecteerd kunnen worden.

De doeltreffendheid van het desinfecteren in de autoclaaf moet door de gebruiker zelf worden gecontroleerd. Niet ieder membraanfilter is daarvoor geschikt! Uitsluitend originele toebehoren gebruiken.

- > Standaard is het apparaat voorzien van een 0,2 µm membraanfilter (rode kleurcode).
- > Het membraanfilter mag maximaal vijf maal op 121°C (250°F) in de autoclaaf worden gedesinfecteerd.
- > Met 0,2 µm membraanfilters (voor weefselkweek) kunnen volumetoleranties uit klasse B worden bereikt.
- > Voor het aanhouden van volumetoleranties uit klasse A zijn 3 µm membraanfilters vereist. Deze hebben door hun wijdere poriën een geringere invloed op de vrije uitlooptijd van de pipetten, zie .

6.3 UV-ontkieming

Het apparaat is bestand tegen de gebruikelijke belasting van een UV-ontkiemingslamp. Als gevolg van UV-straling is verkleuring mogelijk.

7 Storing - wat te doen?





Storing	Oorzaak	Wat te doen?
Zuigvermogen onvoldoende	Motortoerental is verminderd	Motortoerental verhogen, zie Het motortoerental instellen, pag. 457 .
	Terugslagklep gesloten	De keuzeschakelaar op uitblazen zetten en op onderste pipetteerknop drukken, zie Modus selecteren, pag. 456
Pipet lekt	Het filter is niet correct geplaatst	Het filter correct plaatsen, zie Filter vervangen en de adapter reinigen, pag. 462 .
	Adapter of pipet beschadigd	Adapter c.q. pipet vervangen, zie Filter vervangen en de adapter reinigen, pag. 462 .
De pipet zit niet goed in de adapter	Adapter vervuild c.q. beschadigd	De adapter reinigen, aan de lucht drogen c.q. vervangen, zie Filter vervangen en de adapter reinigen, pag. 462 .
De LED-laadindicator brandt/knipperd niet nadat de netadapter is aangesloten en de voedingsspanning in orde is.	De accustekker niet stevig ingestoken	De accustekker stevig insteken, zie Accu aansluiten, pag. 453 .
	Verkeerde netadapter	Alleen een originele netadapter gebruiken, zie Functie- en bedieningselementen, pag. 451
	Accu c.q. netadapter defect	De accu/netadapter vervangen
	Apparaat defect	Het apparaat opsturen ter reparatie, zie Reparatie, pag. 467
Accucapaciteit onvoldoende	Accu defect	De accu vervangen, zie Accu aansluiten, pag. 453 .
Het apparaat doet niets	Interne fout (reset uitvoeren)	De accustekker losmaken en de pipetteerknop 10 sec. lang ingedrukt houden. Dan de accustekker weer stevig insteken, zie Accu aansluiten, pag. 453 en Pipetteren, pag. 459

Als het probleem niet aan de hand van deze storingstabel kan worden opgelost, neem dan contact op met uw leverancier of rechtstreeks met de fabrikant.

8 Technische gegevens

Technische gegevens	Waarden
Laadbus	5 V DC
Netadapter	Input: 100 – 240 V AC, 50/60 Hz Output: 5 V DC
Accu	Accupack NiMH 2,4 V, 730 mAh Oplaadtijd: 4 uur Maximale gebruiksduur: ca. 8 uur Opladtemperatuur: +10°C tot +35°C

8.1 Aanduiding op het product

Teken of nummer	Betekenis
XXZXXXXX	Serienummer
Quick Response Code	Bevat het serienummer
	Met dit teken bevestigen wij dat het product voldoet aan de in de EG-richtlijn vastgelegde eisen en aan de vastgelegde testprocedure werd onderworpen.
	UKCA: United Kingdom Conformity Assessed Met dit teken bevestigen wij dat het product voldoet aan de in de UK Designated Standards vastgelegde eisen.
www.brand.de/ip	Patentinformatie
 (hier: 40 jaar)	China RoHS (EFUP) EFUP definieert de periode in jaren, waarin de in elektrische en elektronische apparaten opgenomen gevaarlijke stoffen onder normale bedrijfsomstandigheden niet weglekken of veranderen. Bij normaal gebruik door de gebruiker leiden dergelijke elektrische en elektronische producten niet tot ernstige verontreiniging van het milieu, tot ernstig lichamelijk letsel of tot beschadigingen aan waardevolle voorwerpen van de gebruiker.
	Het elektrische apparaat mag niet via het huishoudelijke afval worden afgevoerd.

9 Reparatie

9.1 Opsturen ter reparatie

AANWIJZING

Het transport van gevaarlijke materialen zonder uitdrukkelijke toestemming is wettelijk verboden.

Het apparaat grondig reinigen en ontsmetten!

- Geef bij het opsturen van producten a.u.b. altijd een exacte beschrijving van de soort storing en de gebruikte media. Bij het ontbreken van informatie over de gebruikte media kan het apparaat niet gerepareerd worden.
- Stuur het apparaat alleen op zonder accu c.q. batterij.
- Het terugsturen gebeurt voor eigen risico en kosten van de afzender.

Buiten de VS en Canada

"Verklaring dat het product niet gezondheidsbedreigend is" invullen en samen met het apparaat opsturen naar de fabrikant of leverancier. Voorbedrukte formulieren kunnen bij de leverancier of fabrikant worden aangevraagd c.q. kunnen worden gedownload van www.brand.de.

Binnen de VS en Canada

Neem contact op met BrandTech Scientific, Inc. en overleg onder welke voorwaarden u het apparaat kunt opsturen **voordat** u het daadwerkelijk voor service opstuurt.

Stuur uitsluitend gereinigde en gedesinfecteerde apparaten naar het adres, dat u samen met het retournummer hebt ontvangen. Het retournummer goed zichtbaar aan de buitenkant van het pakket aanbrengen.

Contactadressen

Duitsland:

BRAND GMBH + CO KG
Otto-Schott-Straße 25
D-97877 Wertheim (Germany)
T +49 9342 808 0
F +49 9342 808 98000
info@brand.de
www.brand.de

VS en Canada:

BrandTech® Scientific, Inc.
11 Bokum Road
Essex, CT 06426-1506 (USA)
T +1 - 860 - 767 2562
F +1 - 860 - 767 2563
info@brandtech.com
www.brandtech.com

India:

BRAND Scientific Equipment Pvt. Ltd.
303, 3rd Floor, 'C' Wing, Delphi
Hiranandani Business Park,
Powai
Mumbai-400 076 (India)
T +91 22 42957790
F +91 22 42957791
info@brand.co.in
www.brand.co.in

China:

BRAND (Shanghai) Trading Co., Ltd.
Guangqi Culture Plaza
Room 506, Building B
No. 2899, Xietu Road
Shanghai 200030 (P.R. China):
T +86 21 6422 2318
F +86 21 6422 2268
info@brand.com.cn
www.brand.cn.com

10 Bestelinformatie

10.1 Apparaat

Kleur van het bovenste deel van de behuizing	Bestelnr. (met universele netadapter en landenadapter)	Bestelnr. (zonder universele netadapter en zonder landenadapter)
Antraciet	26350	26360
Bessen	26351	26361
Petrol	26352	26362
Amethist	26353	26363

Leveringsomvang, zie . Let op de bestelnummers, met of zonder netadapter.

10.2 Reserveonderdelen

Reserve-membraanfilter

Beschrijving	Verp.eenheid	Bestelnr.
0,2 µm, steriel (rode kleurcode)	1 st. in blisterverpakking	26530
0,2 µm	10 st. in PE-zak	26535
3 µm	1 st. in blisterverpakking	26052
3 µm	10 st. in PE-zak	26056

Netadapter

Technische gegevens van de netadapter, zie Technische gegevens, pag. 466 .

Type	Bestelnr.
Netadapter met landenadapter	26606

Accupack

Technische gegevens van de accu, zie Technische gegevens, pag. 466 .

Beschrijving	Bestelnr.
Accupack NiMH	26630

Siliconenadapter met terugslagklep

Beschrijving	Bestelnr.
Siliconenadapter	26508

Adapterbehuizing

Kleur	Bestelnr.
wit	26658

Wandhouder

Kleur	Bestelnr.
wit	26539

Hechtband

Verp. eenheid	Bestelnr.
3 sets	26547

11 Aansprakelijkheid bij gebreken

Wij kunnen niet aansprakelijk worden gesteld voor de gevolgen van een ondeskundige behandeling, gebruik, onderhoud, bediening of ongeoorloofde reparaties aan het apparaat of voor de gevolgen van normale slijtage, met name bij aan slijtage onderhevige onderdelen zoals bijv. zuigers, afdichtingen, ventielen, evenals voor glasbreuk. Hetzelfde geldt voor het negeren van de gebruiksaanwijzing. In het bijzonder kunnen wij niet aansprakelijk worden gesteld voor ontstane schade als het apparaat verder gedemonteerd werd dan in de gebruiksaanwijzing beschreven of als toebehoren c.q. reserveonderdelen van derden werden ingebouwd.

VS en Canada:

Informatie over de aansprakelijkheid bij gebreken vindt u op www.brandtech.com.

12 Afvalverwerking



Het onderstaande symbool betekent dat batterijen/accu's en elektrische apparaten aan het einde van hun levensduur gescheiden van het huishoudelijke afval (ongesorteerd afval) moet worden afgevoerd in verband met de afvalscheiding.

Elektronische apparaten moeten conform de richtlijn 2012/19/EU van het Europees parlement en de raad van 4 juli 2012 inzake de regeling voor afgedankte elektrische en elektronische apparatuur deskundig en in overeenstemming met de nationale voorschriften worden afgevoerd.

Batterijen en accu's bevatten stoffen, die schadelijk voor het milieu en de gezondheid van mens en dier kunnen zijn. Ze moeten daarom conform de richtlijn 2006/66/EG van het Europees Parlement en de Raad van 6 september 2006 inzake batterijen en accu's deskundig en in overeenstemming met de nationale voorschriften worden afgevoerd. Alleen volledig ontladen batterijen en accu's mogen worden afgevoerd.

EU-Konformitätserklärung | EU Declaration of Conformity

Produktbezeichnung: Product name:	Pipettierhelfer accu-jet® S / Pipetting controller accu-jet® S
Produktvarianten: Product variations:	Anthrazit, Beere, Petrol, Amethyst / anthracite, berry, petrol, amethyst
Art-Nr. / Cat.-No.	26350, 26351, 26352, 26353, 26360, 26361, 26362, 26363

Das oben beschriebene Produkt entspricht den grundlegenden Anforderungen, die in den nachfolgend bezeichneten Harmonisierungsrechtsvorschriften festgelegt sind: The product described above meets the basic requirements that are specified in the harmonization legislation listed below:	Angewendete harmonisierte Normen: Applied harmonized standards:
RoHS: 2011/65/EU incl.2015/863/EU EMC: 2014/30/EU	EN IEC 63000:2018 EN 61326-1:2013
Weitere angewendete Normen: Other applied standards:	Geltungsbereich: Scope:
EN 61010-1:2010, EN 61010-1:2010/A1:2019/AC:2019-04 EN/IEC 62368-1:2014 (angewendet auf Fremdherstellernetzteil / applied to third-party power supply)	NRL / LVD NRL / LVD

Die alleinige Verantwortung für die Ausstellung dieser Konformitätserklärung in Bezug auf die Erfüllung der grundlegenden Anforderungen und die Anfertigung der technischen Unterlagen trägt der Hersteller.

The manufacturer is solely responsible for issuing this declaration of conformity with regard to meeting the essential requirements and preparing the technical documentation.

Hersteller / Manufacturer	Adresse / Address
BRAND GMBH + CO KG	Otto-Schott-Str. 25 97877 Wertheim Germany

Wertheim, 01. Juli 2022 / 01 July 2022



Patrick Ziemeck
Managing Director Technology



i.A. Siegfried Ott
Regulatory Affairs

Diese Erklärung bescheinigt die Übereinstimmung mit den genannten Harmonisierungsvorschriften, beinhaltet jedoch keine Zusicherung von Eigenschaften.

This document declares the accordance with the named harmonized regulations, but does not assure specific properties.

UK Declaration of Conformity

Product name: Pipetting controller accu-jet® S
Product variations: anthracite, berry, petrol, amethyst
Cat.-No. 26350, 26351, 26352, 26353, 26360, 26361, 26362, 26363

The product described above meets the basic requirements that are specified in the harmonization legislation listed below:	Applied harmonized standards:
The Restriction of the Use of Certain Hazardous Substances in Electrical and Electronic Equipment Regulations 2012 (SI 2012 No. 3032)	EN IEC 63000:2018
Electromagnetic Compatibility Regulations 2016 (SI 2016 No. 1091, as amended by SI 2019 No. 696)	EN 61326-1:2013
Other applied standards:	Scope:
EN 61010-1:2010, EN 61010-1:2010/A1:2019/AC:2019-04 EN/IEC 62368-1:2014 (angewendet auf Fremdherstellernetzteil / applied to third-party power supply)	LVD LVD

The manufacturer is solely responsible for issuing this declaration of conformity with regard to meeting the essential requirements and preparing the technical documentation.

Manufacturer	Address
BRAND GMBH + CO KG	Otto-Schott-Str. 25 97877 Wertheim Germany

Wertheim, 18 February 2022



Patrick Ziemeck
Managing Director Technology



i.A. Siegfried Ott
Regulatory Affairs

This document declares the accordance with the named harmonized regulations, but does not assure specific properties.

Declaration of conformity – China RoHS 2

BRAND GMBH + CO KG has made reasonable efforts to ensure that hazardous materials and substances may not be used in BRAND products.

In order to determine the concentration of hazardous substances in all homogeneous materials of the subassemblies, a “Product Conformity Assessment” (PCA) procedure was performed. As defined in GB/T 26572 the “Maximum Concentration Value” limits (MCV) apply to these restricted substances:

+ Lead (Pb):	0.1%	+ Hexavalent chromium (Cr(+VI)):	0.1%
+ Mercury (Hg):	0.1%	+ Polybrominated biphenyls (PBB):	0.1%
+ Cadmium (Cd):	0.01%	+ Polybrominated diphenyl ether (PBDE):	0.1%

Environmental Friendly Use Period (EFUP)

EFUP defines the period in years during which the hazardous substances contained in electrical and electronic products will not leak or mutate under normal operating conditions. During normal use by the user such electrical and electronic products will not result in serious environmental pollution, cause serious bodily injury or damage to the user's assets.

The Environmental Friendly Use Period for BRAND instruments is 40 years.



Material Content Declaration for BRAND Products

部件名称 Part name	有毒有害物质或元素 Hazardous substances					
	铅 Pb	汞 Hg	镉 Cd	六价铬 Cr(+VI)	多溴联苯 PBB	多溴二苯醚 PBDE
包装 / Packaging	0	0	0	0	0	0
塑料外壳 / 组件 Plastic housing / parts	0	0	0	0	0	0
电池 / Battery	0	0	0	0	0	0
玻璃 / Glass	0	0	0	0	0	0
电子电气组件 Electrical and electronic parts	X	0	0	0	0	0
金属外壳 / 组件 Metal housing / parts	X	0	0	0	0	0
电机 / Motor	X	0	0	0	0	0
配件 / Accessories	X	0	0	0	0	0
此表格是按照SJ/T 11364-2014中规定所制定的。 This table is created according to SJ/T 11364-2014.						

- O: 表示该有毒有害物质在该部件所有均质材料中的含量均在GB/T 26572规定的限量要求以下。
- O: Indicates that the above mentioned hazardous substance contained in all homogeneous materials of the part is below the required limit as defined in GB/T 26572.
- X: 表示该有毒有害物质至少在该部件某一均质材料中的含量超出GB/T 26572规定的限量要求。
- X: Indicates that the above mentioned hazardous substance contained in at least one of the homogeneous materials of this part is above the required limit as defined in GB/T 26572.

注释： 电池，玻璃制品和配件可能不属于此设备的一部分且/或可能有它自己的EFUP标志且/或可能包含更改EFUP标志的部件。

Note: Batteries, glassware and accessories might not be content of the enclosed device and/or may have their own EFUP-marking and/or might be maintaining parts with changing EFUP-marking.

除上表所示信息外，还需声明的是，这些部件并非是有用铅 (Pb), 汞 (Hg), 镉 (Cd), 六价铬 (Cr(+VI)), 多溴联苯 (PBB) 或多溴二苯醚 (PBDE) 来制造的。

Apart from the disclosures in the above table, the subassemblies are not intentionally manufactured or formulated with lead (Pb), mercury (Hg), cadmium (Cd), hexavalent chromium (Cr+VI), polybrominated biphenyls (PBB), and polybrominated diphenyl ethers (PBDE).

Products manufactured by BRAND may enter into further devices or can be used together with other appliances. With these third party products and appliances in particular, please note the EFUP labeled on these products. BRAND will not take responsibility for the EFUP of those products and appliances.

Place, date: Wertheim, 05|04|2022



Patrick Ziemeck
(Managing Director Technology)



i.A. Siegfried Ott
(Regulatory Affairs)

Spis treści

1 Wprowadzenie	479
1.1 Zakres dostawy	479
1.2 Warunki użytkowania	479
2 Bezpieczeństwo	481
2.1 Funkcja	482
2.2 Zakresy stosowania	482
2.3 Wyłączenia stosowania	483
2.4 Warunki przechowywania	483
3 Elementy funkcjonalne i obsługowe	484
4 Uruchomienie	486
4.1 Podłączanie akumulatora	486
4.2 Ładowanie akumulatora	488
4.3 Włączanie urządzenia	489
4.4 Wybór trybu pracy	489
4.5 Pobieranie lub wydawanie cieczy	489
4.6 Zmiana prędkości pipetowania	490
4.7 Ustawianie prędkości obrotowej silnika	490
4.8 Przechowywanie urządzenia	490
5 Pipetowanie	492
6 Czyszczenie	494
6.1 Sprawdzanie szczelności	494
6.2 Wymiana filtra i czyszczenie adaptera	494
6.3 Dezynfekcja UV	497
7 Usterka - co robić?	498
8 Dane techniczne	499
8.1 Oznakowanie na produkcie	499

9 Naprawa	500
9.1 Wysyłanie do naprawy	500
10 Informacje dotyczące zamawiania	502
10.1 Urządzenie.....	502
10.2 Części zamienne.....	502
11 Odpowiedzialność za wady.....	504
12 Utylizacja.....	505

1 Wprowadzenie

1.1 Zakres dostawy

Pipetor, akumulator niklowo-metalowo-wodorkowy (NiMH), opcjonalny zasilacz (zwrócić uwagę na różne numery katalogowe), 2 zapasowe filtry membranowe 0,2 μm , uchwyt ścienny, instrukcja obsługi

1.2 Warunki użytkowania





- Przed pierwszym użyciem uważnie przeczytać instrukcję obsługi.
- Instrukcja obsługi jest częścią urządzenia i należy ją przechowywać w łatwo dostępnym miejscu.
- Przekazując urządzenie osobom trzecim, dołączyć instrukcję obsługi.

1.2.1 Poziomy zagrożenia

Poniższe hasła ostrzegawcze wskazują na możliwe zagrożenia:

Hasło ostrzegawcze	Znaczenie
NIEBEZPIECZEŃSTWO	Prowadzi do poważnych obrażeń lub śmierci.
OSTRZEŻENIE	Może prowadzić do poważnych obrażeń lub śmierci.
UWAGA	Może prowadzić do lekkich lub średnich obrażeń ciała.
INFORMACJA	Może prowadzić do uszkodzenia mienia.

1.2.2 Symbole używane w instrukcji obsługi

Symbol	Znaczenie	Symbol	Znaczenie
	Miejsce niebezpieczne		Niebezpieczeństwo wybuchu
	Stosować ochronę oczu		Nosić rękawice ochronne

1.2.3 Sposób prezentacji

Sposób prezentacji	Znaczenie	Sposób prezentacji	Znaczenie
1. Zadanie	Oznacza zadanie.	>	Oznacza warunek.
a., b., c.	Oznacza poszczególne etapy zadania.	⇒	Oznacza wynik.

2 Bezpieczeństwo

Przeczytać uważnie!

Urządzenie laboratoryjne accu-jet® S można stosować w połączeniu z niebezpiecznymi materiałami, procesami pracy i aparaturą. W instrukcji obsługi nie można jednak wskazać wszystkich problemów związanych z bezpieczeństwem, które mogą wystąpić. Użytkownik ma obowiązek zapewnienia przestrzegania przepisów BHP oraz określić odpowiednie ograniczenia przed rozpoczęciem użytkowania.

1. Każdy użytkownik musi przeczytać niniejszą instrukcję obsługi przed rozpoczęciem użytkowania urządzenia oraz stosować się do jej zapisów.
2. Przestrzegać ogólnych wskazówek dotyczących zagrożenia i przepisów dotyczących bezpieczeństwa, np. nosić odzież ochronną, ochronę oczu i rękawice ochronne.
3. Przestrzegać instrukcji producentów odczynników.
4. Nie używać urządzenia w atmosferze wybuchowej i nie pipetować łatwopalnych mediów.
5. Używać urządzenia wyłącznie do pipetowania cieczy i tylko w ramach określonych zakresów stosowania. Przestrzegać wyłączeń stosowania, patrz Wyłączenia stosowania, str. 483 ! W razie wątpliwości skontaktować się z producentem lub sprzedawcą.
6. Pracować zawsze w taki sposób, aby nie powstało zagrożenie dla użytkownika ani innych osób. Unikać rozpryskiwania. Używać wyłącznie odpowiednich pojemników.
7. Nigdy nie używać sity.
8. Stosować wyłącznie oryginalne akcesoria i części zamienne. Nie dokonywać żadnych zmian technicznych. Nie demontować urządzenia w sposób inny niż opisany w instrukcji obsługi!

9. Przed użyciem zawsze sprawdzić stan techniczny urządzenia. W przypadku wystąpienia jakichkolwiek oznak wskazujących na usterkę natychmiast przerwać pipetowanie i postępować zgodnie z instrukcjami zawartymi w rozdziale Störung - Was tun?. W razie potrzeby skontaktować się z producentem.
10. Do ładowania akumulatora niklowo-metalowo-wodorkowego wolno używać wyłącznie oryginalnego zasilacza.
11. Nie wymieniać akumulatora na akumulatory innych producentów.
12. Chronić zasilacz przed wilgocią i używać tylko w połączeniu z tym urządzeniem.
13. Nie używać zasilacza, jeśli przewód przyłączeniowy jest uszkodzony.
14. Przeprowadzać naprawy i ingerować w urządzenie wolno wyłącznie autoryzowanym technikom serwisowym.

2.1 Funkcja

Urządzenie stanowi pomoc przy pipetowaniu cieczy pipetami szklanymi lub z tworzywa sztucznego, jednomiarowymi i z podziałką, o pojemności od 0,1 ml do 200 ml i średnicy zewnętrznej rurki ssącej <9,2 mm. W przypadku prawidłowego postępowania pipetowana ciecz styka się tylko z pipetą.

2.2 Zakresy stosowania

Urządzenie służy do pipetowania cieczy przy zachowaniu następujących granic fizycznych:

- od +10°C do +40°C (od 50°F do 104°F) (urządzenie i odczytnik)
- Ciśnienie pary do maks. 500 mbar. Powyżej 300 mbar zasysać powoli, aby uniknąć wrzenia cieczy.
- Gęstość do 9 g/cm³

2.3 Wyłączenia stosowania

Urządzenia nie wolno stosować do cieczy, których pary mają działanie korozyjne lub szkodliwe dla materiałów takich jak silikon lub EPDM.

Urządzenie nie nadaje się do stosowania z pipetami Pasteura.

OSTRZEŻENIE



Eksplatacja urządzenia w atmosferze wybuchowej

Urządzenia nie wolno używać lub ładować w atmosferze wybuchowej. Nie wolno pipetować mediów wysoce łatwopalnych (temperatura zapłonu poniżej 0°C (32°F), np. eter, aceton).

2.4 Warunki przechowywania

Urządzenie i akcesoria przechowywać w czystości, w chłodnym, suchym miejscu.

Temperatura przechowywania: od -20°C do + 50°C (od -4°F do 122°F).

Wilgotność względna powietrza: 5% do 95%.

3 Elementy funkcjonalne i obsługowe

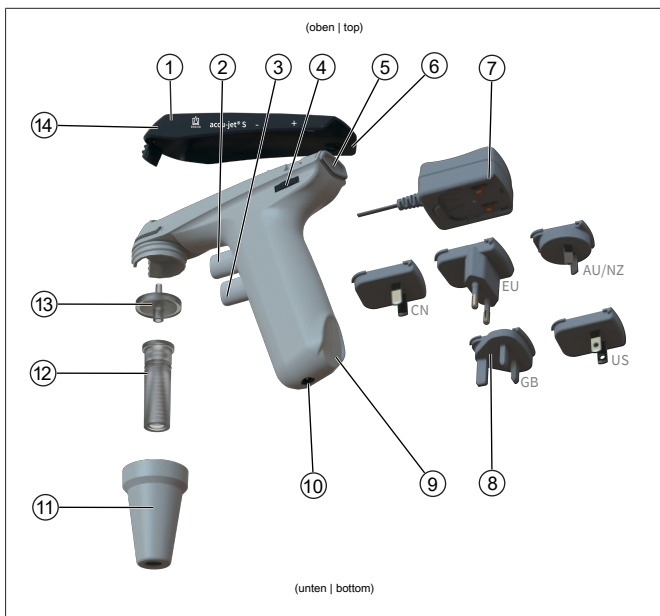

- | | |
|--|---|
| 1 Górna część obudowy | 2 Górny przycisk pipetowania (pobieranie cieczy) |
| 3 Dolny przycisk pipetowania (wydawanie cieczy) | 4 Pokrętko nastawcze prędkości obrotowej silnika |
| 5 Przełącznik wyboru trybu pracy | 6 Powierzchnia do odstawiania na górnej części obudowy |
| 7 Zasilacz | 8 Adapter krajowy |
| 9 Powierzchnia do odstawiania na uchwycie | 10 Gniazdo ładowania |
| 11 Obudowa adaptera (PP) | 12 Adapter / zawór zwrotny (SI/PTFE) |
| 13 Filtr membranowy (PP/PTFE) | 14 Otwór wyrównywania ciśnienia |

Informacje na temat napięcia i poboru prądu, patrz Dane techniczne, str. 499.

Skrót	Materiał
PP	polipropylen
PTFE	politetrafluoroetylen
SI	silikon

4 Uruchomienie

4.1 Podłączanie akumulatora

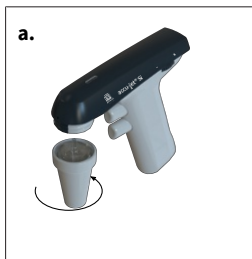

- a.** Odkręcić obudowę adaptera. Adapter i filtr pozostają w obudowie adaptera.

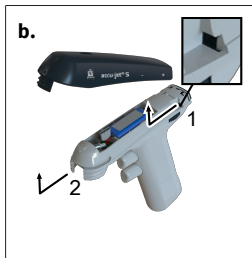

- b.** Zdjąć obudowę. Lekko przesunąć obudowę w kierunku połączenia śrubowego obudowy adaptera.

⇒ Obudowa odłącza się od zagłębień nad pokrętkiem nastawczym (1) i od połączenia śrubowego obudowy adaptera (2).

⇒ Komora akumulatora staje się widoczna.

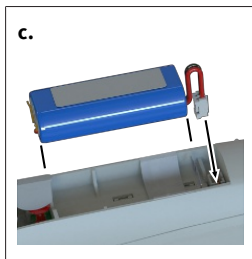

- c.** Przytrzymać wtyczkę akumulatora za kabel, ustawić ją odpowiednio i umieścić w gnieździe tak, aby dało się słyszeć odgłos zatrzaśnięcia. Włożyć akumulator.

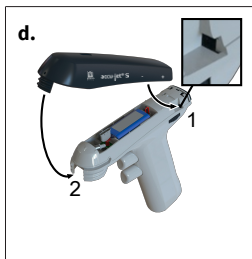

- d.** Nałożyć obudowę. Upewnić się, że obudowa zazębiła się w odpowiednich zagłębieniach nad pokrętkiem nastawczym (1) i w połączeniu śrubowym obudowy adaptera (2).

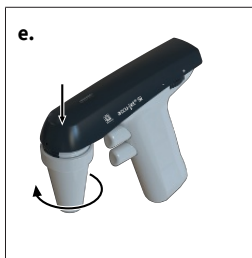

- e.** Docisnąć górną część obudowy do pozostałej części i przykręcić obudowę adaptera.

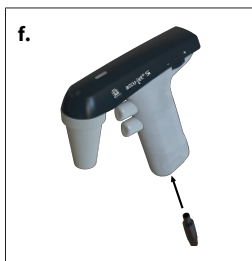

- f.** Ładować akumulator, aż wskaźnik ładowania LED zacznie migać na zielono. Czas ładowania ok. 4 godziny, patrz ładowanie akumulatora.

4.2 Ładowanie akumulatora

⚠ OSTRZEŻENIE



Uszkodzony zasilacz lub kabel ładowania

Ryzyko obrażeń spowodowanych porażeniem prądem elektrycznym.



- > Nie używać uszkodzonego zasilacza.
- > Jeśli kabel ładowania jest uszkodzony, nie używać zasilacza.

UWAGA

Używać wyłącznie oryginalnego zasilacza producenta!

Użycie innego zasilacza może spowodować uszkodzenie urządzenia i akumulatora.

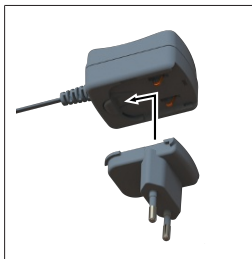

- a. Podłączyć adapter krajowy do zasilacza.
 - b. Podłączyć zasilacz do urządzenia.
 - c. Podłączyć zasilacz do wtyczki sieciowej.
- ⇒ Urządzenie jest ładowane. Można to rozpoznać po wskaźniku ładowania LED na górnej części obudowy. Czas pracy i ładowania, patrz Dane techniczne, str. 499 .

Wskaźnik ładowania LED	Status	Co robić?
Zielony: miga	Akumulator jest naładowany. Trwa ładowanie podtrzymujące.	Można pracować z urządzeniem. Urządzenie jest całkowicie naładowane.
Zielony: świeci światłem ciągłym	Ładowanie akumulatora	Pracę można kontynuować również podczas ładowania.
Czerwony: miga	Akumulator jest prawie rozładowany.	Przerwać pracę z urządzeniem. Naładować akumulator. Pracę można kontynuować również podczas ładowania.

Wskaźnik ładowania LED	Status	Co robić?
Czerwony: świeci światłem ciągłym	Akumulator jest rozładowany.	Naładować akumulator.

UWAGA

- > Ładowanie podtrzymujące zapobiega przeładowaniu akumulatora i minimalizuje efekt pamięci. Aby zachować maksymalną pojemność, ładować akumulator dopiero po zasygnalizowaniu takiej konieczności przez wskaźnik ładowania LED.

4.3 Włączanie urządzenia

Urządzenie jest gotowe do pracy po włożeniu naładowanego akumulatora. Nie ma przełącznika ON/OFF.

4.4 Wybór trybu pracy

Przełącznik wyboru, patrz Elementy funkcjonalne i obsługowe, str. 484.

Tryb pracy „Grawitacyjny”: przesunąć przełącznik wyboru w górę.

Tryb pracy „Wydmuchiwanie wspomagane silnikiem”: przesunąć przełącznik wyboru w dół.

4.5 Pobieranie lub wydawanie cieczy

Przycisk pipetowania, patrz Elementy funkcjonalne i obsługowe, str. 484

Górny przycisk pipetowania służy do napełniania pipety, a dolny przycisk pipetowania do wydawania cieczy.

4.6 Zmiana prędkości pipetowania

Prędkość jest ograniczona przez ustawioną maksymalną prędkość obrotową silnika. Im mocniej wciśnięty jest górny lub dolny przycisk pipetowania, tym szybsze jest pobieranie lub wydawanie cieczy.

4.7 Ustawianie prędkości obrotowej silnika

Pokrętło nastawcze, patrz Elementy funkcjonalne i obsługowe, str. 484

Prędkość obrotową silnika można płynnie regulować od maksimum (+) do minimum (-) poprzez obracanie pokrętła nastawczego. Zalecamy ustawienie maksymalnej prędkości obrotowej silnika dla pipet o dużej pojemności i niższej prędkości obrotowej silnika dla pipet o małej pojemności.

4.8 Przechowywanie urządzenia

4.8.1 Odstawianie na stole

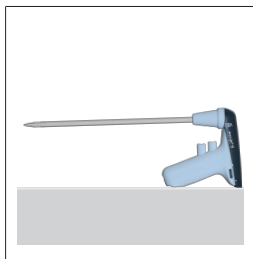

accu-jet® S wraz z włożoną pipetą można odstawić na płaskiej powierzchni.

4.8.2 Uchwyt ścienny



- a. Wyczyścić powierzchnię montażu odpowiednim środkiem czyszczącym (nie używać środków czyszczących o działaniu regenerującym stosowanych w gospodarstwie domowym) i nieklejącą szmatką, a następnie pozostawić do całkowitego wyschnięcia.
- b. Zdjąć folię ochronną z taśmy samoprzylepnej
- c. **Mocno** docisnąć uchwyt ścienny do powierzchni montażu.

5 Pipetowanie

1. Zakładanie pipety

⚠ OSTRZEŻENIE



Upewnić się, że pipeta jest stabilnie osadzona. Nigdy nie używać siły! Szczególnie w przypadku cienkich pipet istnieje ryzyko stłuczenia szkła! Niebezpieczeństwo skaleczenia!

1.



- a. Pipetę trzymać jak najbliżej górnego końca i ostrożnie wsuwać ją do adaptera, aż osadzenie będzie stabilne.
- b. Urządzenie z włożoną pipetą trzymać pionowo, z końcówką skierowaną w dół.

2. Napętnianie pipety

2.

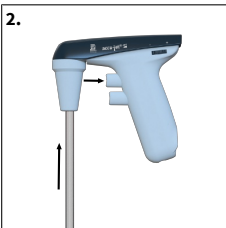

- a. Zanurzyć końcówkę pipety w cieczy.
- b. Powoli naciskać górny przycisk pipetowania i napełnić pipetę tak, aby menisk znajdował się nieco powyżej żądanych oznaczeń.
- c. Naciśnięcie obu przycisków umożliwi bardzo precyzyjne pobieranie i wydawanie cieczy. Jest to szczególnie pomocne podczas ustawiania menisku lub w przypadku stosowania pipet o małych pojemnościach.

Nie przepelniać pipety.

3. Regulacja objętości

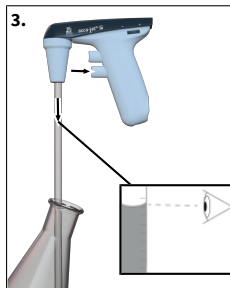

- 3.**
 - a.** W razie potrzeby wytrzeć końcówkę pipety odpowiednią, niekłaczącą szmatką.
 - b.** Powoli naciskać dolny przycisk pipetowania i wydawać ciecz, aż menisk znajdzie się dokładnie na żądanym oznaczeniu.

4. Opróżnianie pipety

- a.** Powoli naciskać dolny przycisk pipetowania. Prędkość pipetowania zależy od tego, jak mocno naciskane są przyciski pipetowania. W trybie pracy „Wydmuchiwanie ze wspomaganie silnika” zależy to również od ustawionej prędkości obrotowej silnika.

5. Po pipetowaniu

- a.** Chwycić pipetę jak najwyżej i wyciągnąć ją z adaptera.

6 Czyszczenie

UWAGA

accu-jet® S nie nadaje się do sterylizacji w autoklawie

Od czasu do czasu przetrzeć części obudowy wilgotną szmatką. W przypadku prawidłowego użytkowania urządzenie nie wymaga konserwacji.

6.1 Sprawdzanie szczelności

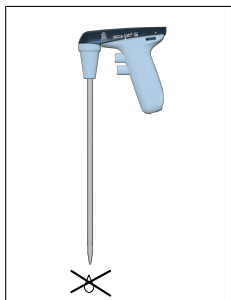

Po ustawieniu menisku z pipety nie może kapać ciecz bez uruchomienia zaworów. Jeśli z pipety kapie ciecz, patrz Usterka - co zrobić?

6.2 Wymiana filtra i czyszczenie adaptera

⚠ OSTRZEŻENIE



Niebezpieczeństwo skażenia i zakażenia

Stosować rękawice ochronne i ochronę oczu.



UWAGA

Wymiana lub czyszczenie filtra jest konieczne tylko w przypadku, gdy pipeta została przepełniona lub gdy pogorszyła się wydajność zasysania.

b.



- a.** Wyciągnąć pipetę.
- b.** Odkręcić obudowę adaptera.
- c.** Zdjąć górną część obudowy.

d.



- d.** Wypchnąć adapter i filtr membranowy od zakończonej stożkowo strony obudowy adaptera.

e.



- e.** Zdjąć uszkodzony filtr membranowy.

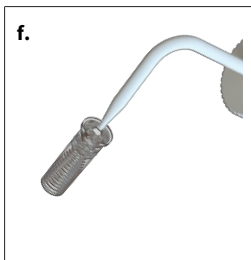

- f.** W celu wyczyszczenia ostrożnie przepłukać adapter przy użyciu butelki z rozpylaczem wypełnionej odpowiednim płynem czyszczącym, np. wodą. Następnie przedmuchać i wysuszyć.

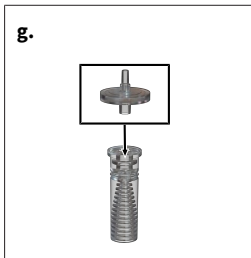

- g.** Najpierw wcisnąć nowy filtr membranowy do adaptera grubszym przyłączem skierowanym w dół (cieńsza, stożkowa strona skierowana w górę), a następnie włożyć go do obudowy adaptera.

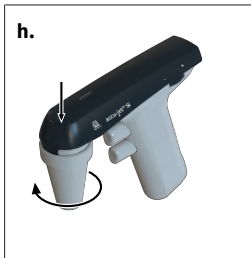

- h.** Docisnąć górną część obudowy do pozostałej części i przykręcić obudowę adaptera.

Informacja dotycząca filtrów przystosowanych do sterylizacji w autoklawie

Skuteczność autoklawowania użytkownik musi zawsze sprawdzić sam. Nie każdy filtr membranowy jest do tego przystosowany! Stosować wyłącznie oryginalne akcesoria.

- > Urządzenie jest seryjnie wyposażone w filtr membranowy 0,2 µm (czerwony kod).
 - > Filtr membranowy może być sterylizowany w autoklawie maksymalnie pięć razy w temperaturze 121°C (250°F).
 - > Z filtrem membranowym 0,2 µm (do hodowli komórkowych) można osiągnąć tolerancję objętości klasy B.
 - > Do zachowania tolerancji objętości klasy A wymagane są filtry membranowe 3 µm. Ze względu na mniejszy rozmiar porów mają one mniejszy wpływ na czas swobodnego wypływu z pipet, patrz .
-

6.3 Dezynfekcja UV

Urządzenie jest odporne na normalne działanie lampy dezynfekującej UV. W wyniku ekspozycji na promieniowanie UV możliwa jest zmiana koloru.

7 Usterka - co robić?





Usterka	Przyczyna	Co robić?
Zmniejszenie wydajności zasysania	Zredukowana prędkość obrotowa silnika	Zwiększyć prędkość obrotową silnika, patrz Ustawianie prędkości obrotowej silnika, str. 490 .
	Zamknięty zawór zwrotny	Ustawić przełącznik wyboru w pozycji wydmuchiwania i nacisnąć dolny przycisk pipetowania, patrz Wybór trybu pracy, str. 489
Z pipety kapie ciecz	Filtr nie jest osadzony prawidłowo	Włożyć filtr prawidłowo, patrz Wymiana filtra i czyszczenie adaptera, str. 494 .
	Uszkodzenie adaptera lub pipety	Wymienić adapter lub pipetę, patrz Wymiana filtra i czyszczenie adaptera, str. 494 .
Pipeta nie trzyma się w adapterze	Adapter zabrudzony lub uszkodzony	Oczyszczyć adapter, osuszyć powietrzem, w razie potrzeby wymienić, patrz Wymiana filtra i czyszczenie adaptera, str. 494 .
Wskaźnik ładowania LED nie świeci / nie miga po podłączeniu zasilacza i zapewnieniu zasilania.	Wtyczka akumulatora nie jest odpowiednio mocno włożona	Wetknąć wtyczkę akumulatora odpowiednio mocno, patrz Podłączenie akumulatora, str. 486 .
	Niewłaściwy zasilacz	Używać tylko oryginalnego zasilacza, patrz Elementy funkcjonalne i obsługowe, str. 484
	Uszkodzony akumulator lub zasilacz	Wymienić akumulator / zasilacz
	Uszkodzenie urządzenia	Wysłać urządzenie do naprawy, patrz Naprawa, str. 500
Mała pojemność baterii	Uszkodzony akumulator	Wymień akumulator, patrz Podłączenie akumulatora, str. 486 .
Urządzenie nie działa	Błąd wewnętrzny (wykonać reset)	Odłączyć wtyczkę akumulatora i przytrzymać przycisk pipetowania wciśnięty przez 10 sekund. Następnie ponownie mocno podłączyć wtyczkę akumulatora, patrz Podłączenie akumulatora, str. 486 i Pipetowanie, str. 492

Jeśli problem nie zostanie rozwiązany na podstawie powyższej tabeli usterek, skontaktować się ze sprzedawcą lub bezpośrednio z producentem.

8 Dane techniczne

Dane techniczne	Wartości
Gniazdo ładowania	5 V DC
Zasilacz	Wejście: 100 – 240 V AC, 50/60 Hz Wyjście: 5 V DC
Akumulator	Akumulator NiMH 2,4 V, 730 mAh Czas ładowania: 4 h Maksymalny czas pracy: ok. 8 h Temperatura ładowania: +10°C do +35°C

8.1 Oznakowanie na produkcie

Znak lub numer	Znaczenie
XXZXXXXX	Numer seryjny
Quick Response Code	Zawiera numer seryjny
	Tym znakiem potwierdzamy, że produkt spełnia wymagania określone w dyrektywach WE i został poddany określonym procedurom testowym.
	UKCA: United Kingdom Conformity Assessed Tym symbolem potwierdzamy, że produkt spełnia wymagania określone w UK Designated Standards.
www.brand.de/ip	Informacje o patentach
 (tutaj: 40 lat)	China RoHS (EFUP) EFUP definiuje okres w latach, w którym substancje niebezpieczne zawarte w urządzeniach elektrycznych i elektronicznych nie wyciekają ani nie ulegają zmianie w normalnych warunkach eksploatacji. Podczas normalnego użytkowania takie produkty elektryczne i elektroniczne nie powodują poważnego zanieczyszczenia środowiska, poważnych obrażeń ciała ani uszkodzenia mienia użytkownika.
	Tego urządzenia elektrycznego nie wolno wyrzucać wraz z odpadami domowymi.

9 Naprawa

9.1 Wysyłanie do naprawy

UWAGA

Istnieje ustawowy zakaz transportu materiałów niebezpiecznych bez zezwolenia.

Dokładnie oczyścić i odkazić urządzenie!

- W przypadku zwrotu dołączyć do produktu dokładny opis rodzaju usterki i używanych mediów. W przypadku braku informacji dotyczących używanych mediów naprawa urządzenia nie jest możliwa.
- Urządzenie należy wysłać bez akumulatora / baterii.
- Transport zwracanego produktu odbywa się na ryzyko i koszt nadawcy.

Poza USA i Kanadą

Wypełnić „Deklarację bezpieczeństwa dla zdrowia” i wysłać ją wraz z urządzeniem do producenta lub sprzedawcy. Formularze można zamówić u sprzedawcy lub producenta, są również dostępne do pobrania na stronie www.brand.de.

Na terenie USA i Kanady

Przed wysłaniem urządzenia do serwisu skontaktować się z firmą Brand-Tech Scientific, Inc. w sprawie wymagań dotyczących zwrotu.

Czyste i odkazię urządzenie należy wysłać na adres otrzymany wraz z numerem zwrotu. Numer zwrotu przykleić na paczce w dobrze widocznym miejscu.

Adresy kontaktowe

Niemcy:

BRAND GMBH + CO KG
Otto-Schott-Straße 25
97877 Wertheim (Niemcy)
T +49 9342 808 0
F +49 9342 808 98000
info@brand.de
www.brand.de

USA i Kanada:

BrandTech® Scientific, Inc.
11 Bokum Road
Essex, CT 06426-1506 (USA)
T +1-860-767 2562
F +1-860-767 2563
info@brandtech.com
www.brandtech.com

Indie:

BRAND Scientific Equipment Pvt. Ltd.
303, 3rd Floor, 'C' Wing, Delphi
Hiranandani Business Park,
Powai
Mumbai-400 076 (Indie)
T +91 22 42957790
F +91 22 42957791
info@brand.co.in
www.brand.co.in

Chiny:

BRAND (Shanghai) Trading Co., Ltd.
Guangqi Culture Plaza
Room 506, Building B
No. 2899, Xietu Road
Shanghai 200030 (Chiny)
T +86 21 6422 2318
F +86 21 6422 2268
info@brand.com.cn
www.brand.cn.com

10 Informacje dotyczące zamawiania

10.1 Urządzenie

Kolor górnej części obudowy	Nr kat. (z zasilaczem uniwersalnym i adapterem krajowym)	Nr kat. (bez zasilacza uniwersalnego i bez adaptera krajowego)
Antracytowy	26350	26360
Jagodowy	26351	26361
Petrol	26352	26362
Ametyst	26353	26363

Zakres dostawy, patrz . Zwrócić uwagę na numery katalogowe, z zasilaczem lub bez.

10.2 Części zamienne

Zapasyowy filtr membranowy

Opis	Jedn. opak.	Nr kat.
0,2 µm, sterylny (czerwony kod)	1 szt. w opakowaniu typu blister	26530
0,2 µm	10 szt. w woreczku PE	26535
3 µm	1 szt. w opakowaniu typu blister	26052
3 µm	10 szt. w woreczku PE	26056

Zasilacz

Dane techniczne zasilacza, patrz Dane techniczne, str. 499 .

Typ	Nr kat.
Zasilacz z adapterem krajowym	26606

Akumulator

Dane techniczne akumulatora, patrz Dane techniczne, str. 499 .

Opis	Nr kat.
Akumulator NiMH	26630

Adapter silikonowy z zaworem zwrotnym

Opis	Nr kat.
Adapter silikonowy	26508

Obudowa adaptera

Kolor	Nr kat.
biały	26658

Uchwyt ścienny

Kolor	Nr kat.
biały	26539

Taśma samoprzylepna

Jedn. opak.	Nr kat.
3 zestawy	26547

11 Odpowiedzialność za wady

Nie ponosimy odpowiedzialności za skutki niewłaściwego obchodzenia się z urządzeniem, nieprawidłowego użytkowania, konserwacji, obsługi lub nieautoryzowanych napraw oraz za skutki normalnego zużycia, w szczególności części zużywających się, takich jak tłoki, uszczelki, zawory oraz w przypadku stłuczenia szkła. To samo dotyczy nieprzestrzegania zapisów instrukcji obsługi. W szczególności nie ponosimy odpowiedzialności za szkody powstałe w wyniku demontażu urządzenia w sposób wykraczający poza opisany w instrukcji obsługi lub w wyniku montażu akcesoriów lub części zamiennych innych firm.

USA i Kanada:

Informacje na temat odpowiedzialności za wady można znaleźć na stronie www.brandtech.com.

12 Utylizacja



Widoczny obok symbol oznacza, że po zakończeniu okresu użytkowania baterie/akumulatory i urządzenia elektroniczne należy utylizować oddzielnie od odpadów domowych (niesegregowanych odpadów komunalnych).

Zgodnie z dyrektywą Parlamentu Europejskiego i Rady 2012/19/UE z dnia 04 lipca 2012 r. w sprawie zużytego sprzętu elektrycznego i elektronicznego urządzenia elektroniczne należy utylizować zgodnie z krajowymi przepisami dotyczącymi utylizacji.

Baterie i akumulatory zawierają substancje, które mogą mieć szkodliwy wpływ na środowisko i zdrowie ludzi. W związku z tym zgodnie z dyrektywą Parlamentu Europejskiego i Rady 2006/66/WE z dnia 6 września 2006 r. w sprawie baterii i akumulatorów należy je utylizować zgodnie z krajowymi przepisami dotyczącymi utylizacji. Utylizować wyłącznie baterie i akumulatory, które są całkowicie rozładowane.

EU-Konformitätserklärung | EU Declaration of Conformity

Produktbezeichnung: Product name:	Pipettierhelfer accu-jet® S / Pipetting controller accu-jet® S
Produktvarianten: Product variations:	Anthrazit, Beere, Petrol, Amethyst / anthracite, berry, petrol, amethyst
Art-Nr. / Cat.-No.	26350, 26351, 26352, 26353, 26360, 26361, 26362, 26363

Das oben beschriebene Produkt entspricht den grundlegenden Anforderungen, die in den nachfolgend bezeichneten Harmonisierungsrechtsvorschriften festgelegt sind: The product described above meets the basic requirements that are specified in the harmonization legislation listed below:	Angewendete harmonisierte Normen: Applied harmonized standards:
RoHS: 2011/65/EU incl.2015/863/EU EMC: 2014/30/EU	EN IEC 63000:2018 EN 61326-1:2013
Weitere angewendete Normen: Other applied standards:	Geltungsbereich: Scope:
EN 61010-1:2010, EN 61010-1:2010/A1:2019/AC:2019-04 EN/IEC 62368-1:2014 (angewendet auf Fremdherstellernetzteil / applied to third-party power supply)	NRL / LVD NRL / LVD

Die alleinige Verantwortung für die Ausstellung dieser Konformitätserklärung in Bezug auf die Erfüllung der grundlegenden Anforderungen und die Anfertigung der technischen Unterlagen trägt der Hersteller.

The manufacturer is solely responsible for issuing this declaration of conformity with regard to meeting the essential requirements and preparing the technical documentation.

Hersteller / Manufacturer	Adresse / Address
BRAND GMBH + CO KG	Otto-Schott-Str. 25 97877 Wertheim Germany

Wertheim, 01. Juli 2022 / 01 July 2022



Patrick Ziemeck
Managing Director Technology



i.A. Siegfried Ott
Regulatory Affairs

Diese Erklärung bescheinigt die Übereinstimmung mit den genannten Harmonisierungsvorschriften, beinhaltet jedoch keine Zusicherung von Eigenschaften.

This document declares the accordance with the named harmonized regulations, but does not assure specific properties.

UK Declaration of Conformity

Product name: Pipetting controller accu-jet® S
Product variations: anthracite, berry, petrol, amethyst
Cat.-No. 26350, 26351, 26352, 26353, 26360, 26361, 26362, 26363

The product described above meets the basic requirements that are specified in the harmonization legislation listed below:	Applied harmonized standards:
The Restriction of the Use of Certain Hazardous Substances in Electrical and Electronic Equipment Regulations 2012 (SI 2012 No. 3032)	EN IEC 63000:2018
Electromagnetic Compatibility Regulations 2016 (SI 2016 No. 1091, as amended by SI 2019 No. 696)	EN 61326-1:2013
Other applied standards:	Scope:
EN 61010-1:2010, EN 61010-1:2010/A1:2019/AC:2019-04 EN/IEC 62368-1:2014 (angewendet auf Fremdherstellernetzteil / applied to third-party power supply)	LVD LVD

The manufacturer is solely responsible for issuing this declaration of conformity with regard to meeting the essential requirements and preparing the technical documentation.

Manufacturer	Address
BRAND GMBH + CO KG	Otto-Schott-Str. 25 97877 Wertheim Germany

Wertheim, 18 February 2022



Patrick Ziemeck
Managing Director Technology



i.A. Siegfried Ott
Regulatory Affairs

This document declares the accordance with the named harmonized regulations, but does not assure specific properties.

Declaration of conformity – China RoHS 2

BRAND GMBH + CO KG has made reasonable efforts to ensure that hazardous materials and substances may not be used in BRAND products.

In order to determine the concentration of hazardous substances in all homogeneous materials of the subassemblies, a “Product Conformity Assessment” (PCA) procedure was performed. As defined in GB/T 26572 the “Maximum Concentration Value” limits (MCV) apply to these restricted substances:

+ Lead (Pb):	0.1%	+ Hexavalent chromium (Cr(+VI)):	0.1%
+ Mercury (Hg):	0.1%	+ Polybrominated biphenyls (PBB):	0.1%
+ Cadmium (Cd):	0.01%	+ Polybrominated diphenyl ether (PBDE):	0.1%

Environmental Friendly Use Period (EFUP)

EFUP defines the period in years during which the hazardous substances contained in electrical and electronic products will not leak or mutate under normal operating conditions. During normal use by the user such electrical and electronic products will not result in serious environmental pollution, cause serious bodily injury or damage to the user's assets.

The Environmental Friendly Use Period for BRAND instruments is 40 years.



Material Content Declaration for BRAND Products

部件名称 Part name	有毒有害物质或元素 Hazardous substances					
	铅 Pb	汞 Hg	镉 Cd	六价铬 Cr(+VI)	多溴联苯 PBB	多溴二苯醚 PBDE
包装 / Packaging	0	0	0	0	0	0
塑料外壳 / 组件 Plastic housing / parts	0	0	0	0	0	0
电池 / Battery	0	0	0	0	0	0
玻璃 / Glass	0	0	0	0	0	0
电子电气组件 Electrical and electronic parts	X	0	0	0	0	0
金属外壳 / 组件 Metal housing / parts	X	0	0	0	0	0
电机 / Motor	X	0	0	0	0	0
配件 / Accessories	X	0	0	0	0	0

此表格是按照SJ/T 11364-2014中规定所制定的。

This table is created according to SJ/T 11364-2014.

- O: 表示该有毒有害物质在该部件所有均质材料中的含量均在GB/T 26572规定的限量要求以下。
O: Indicates that the above mentioned hazardous substance contained in all homogeneous materials of the part is below the required limit as defined in GB/T 26572.
- X: 表示该有毒有害物质至少在该部件某一均质材料中的含量超出GB/T 26572规定的限量要求。
X: Indicates that the above mentioned hazardous substance contained in at least one of the homogeneous materials of this part is above the required limit as defined in GB/T 26572.

注释： 电池，玻璃制品和配件可能不属于此设备的一部分且/或可能有它自己的EFUP标志且/或可能包含更改EFUP标志的部件。

Note: Batteries, glassware and accessories might not be content of the enclosed device and/or may have their own EFUP-marking and/or might be maintaining parts with changing EFUP-marking.

除上表所示信息外，还需声明的是，这些部件并非是有用铅 (Pb), 汞 (Hg), 镉 (Cd), 六价铬 (Cr(+VI)), 多溴联苯 (PBB) 或多溴二苯醚 (PBDE) 来制造的。

Apart from the disclosures in the above table, the subassemblies are not intentionally manufactured or formulated with lead (Pb), mercury (Hg), cadmium (Cd), hexavalent chromium (Cr+VI), polybrominated biphenyls (PBB), and polybrominated diphenyl ethers (PBDE).

Products manufactured by BRAND may enter into further devices or can be used together with other appliances. With these third party products and appliances in particular, please note the EFUP labeled on these products. BRAND will not take responsibility for the EFUP of those products and appliances.

Place, date: Wertheim, 05|04|2022



Patrick Ziemeck
(Managing Director Technology)



i.A. Siegfried Ott
(Regulatory Affairs)

İçerik

1 Giriş	512
1.1 Teslimat kapsamı	512
1.2 Kullanım amacı	512
2 Güvenlik	514
2.1 İşlev	515
2.2 Kullanım sınırları	515
2.3 Kullanım istisnaları	515
2.4 Depolama koşulları	516
3 Fonksiyon ve işletim elemanları	517
4 Çalıştırma	519
4.1 Bataryayı takma	519
4.2 Bataryanın şarj edilmesi	521
4.3 Cihazı başlatmak	522
4.4 İşletim türünün seçilmesi	522
4.5 Sıvı çekme veya bırakma	522
4.6 Pipetleme hızının değiştirilmesi	522
4.7 Motor devir sayısını ayarlama.....	523
4.8 Cihazın muhafaza edilmesi.....	523
5 Pipetleme	525
6 Temizleme	527
6.1 Sızdırmazlığın kontrol edilmesi.....	527
6.2 Filtrenin değiştirilmesi ve adaptörün temizlenmesi	528
6.3 UV Sterilizasyon.....	530
7 Arıza - Ne yapmalı?	531
8 Teknik veriler	532
8.1 Ürün üzerinde işaretleme	532
9 Onarım	533
9.1 Onarım için gönderme	533

10 Sipariş bilgileri	535
10.1 Cihaz	535
10.2 Yedek parçalar.....	535
11 Kusur sorumluluğu	537
12 Bertaraf etme.....	538

1 Giriş

1.1 Teslimat kapsamı

Pipet kontrolörü, nikel-metal hidrit batarya, güç adaptörü opsiyonel (farklı sipariş numaralarına dikkat edin), 2 yedek membran filtresi 0,2 µm, duvar desteği, kullanım kılavuzu

1.2 Kullanım amacı



- İlk kullanımdan önce kullanım kılavuzunu dikkatlice okuyun.
- Kullanım kılavuzu bu cihazın bir parçasıdır ve kolay ulaşılabilecek bir yerde muhafaza edilmelidir.
- Cihazı üçüncü şahıslara verdiğinizde bu kullanım kılavuzunu da birlikte teslim edin.

1.2.1 Tehlike seviyeleri

Şu anahtar kelimeler olası tehlikeleri işaretlemektedir:

Anahtar kelime	Anlamı
TEHLİKE	Ağır yaralanma veya ölüme neden olur.
UYARI	Ağır yaralanma veya ölüme neden olabilir.
DİKKAT	Hafif veya orta ağırlıkta yaralanmalara neden olabilir.
BİLGİ	Maddi hasara neden olabilir.

1.2.2 Kullanım kılavuzundaki semboller

Sembol	Anlamı	Sembol	Anlamı
	Tehlike noktası		Patlama tehlikesi

Sembol	Anlamı	Sembol	Anlamı
	Göz koruma gözlüğü takın		Koruyucu eldiven takın

1.2.3 Şekil

Şekil	Anlamı	Şekil	Anlamı
1. Görev	Bir görevi işaret etmektedir.	>	Bir şartı işaret etmektedir.
a., b., c.	Görevin münferit adımlarını işaret etmektedir.	⇒	Bir sonucu işaret etmektedir.

2 Güvenlik

Lütfen mutlaka dikkatli şekilde tamamen okuyun!

Laboratuvar cihazı accu-jet® S tehlikeli maddeler, iş süreçleri ve aparatlar ile kombineli olarak kullanılabilir. Ancak kullanım kılavuzu bu durumda ortaya çıkabilecek tüm güvenlik sorunlarını gösteremez. Güvenlik ve sağlık düzenlemelerine uyulması ve gerekli kısıtlamaların kullanım öncesinde yerine getirilmesi, kullanıcının sorumluluğundadır.

1. Her kullanıcının cihazı kullanmadan önce kullanım kılavuzunu okumuş olması ve incelemesi gerekmektedir.
2. Genel tehlike uyarıları ve güvenlik düzenlemelerine uyun, örn. koruma kıyafeti, göz koruması ve koruyucu eldiven takın.
3. Reaktif üreticilerinin bilgilendirmelerini dikkate alın.
4. Cihazı patlayıcı riski olan ortamlarda kullanmayın ve parlayıcı maddeleri pipetlemeyin.
5. Cihazı sadece sıvıların pipetlenmesi ve tanımlanmış olan kullanım sınırları içerisinde kullanın. Kullanım istisnalarını dikkate alın, bakınız Kullanım istisnaları, sayfa 515 ! Şüphe durumunda mutlaka üretici veya satıcıya başvurun.
6. Daima kullanıcı ve diğer kişilerin tehlike altına sokmayacak şekilde çalışın. Sıçramalardan kaçının. Sadece uygun kapları kullanın.
7. Asla güç kullanmayın.
8. Sadece orijinal ekipman ve orijinal yedek parçaları kullanın. Teknik değişiklik yapmayın. Cihazı, kullanım kılavuzunda tanımlandığından daha fazla sökmeyin!
9. Kullanmadan önce cihazın uygun durumda olduğunu kontrol edin. Cihazda arızalar belirdiği takdirde, pipetlemeyi bırakın ve Störung - Was tun? bölümüne uyun. Gerekliğinde üreticiye başvurun.
10. Nikel-metal hidrit bataryanın şarj edilmesi için sadece orijinal güç adaptörü kullanılmalıdır.
11. Batarya, başka üreticilerin bataryası ile değiştirilmemelidir.

12. Güç adaptörü neme karşı korunmalı ve sadece bu cihaz ile bağlantılı olarak çalıştırılmalıdır.
13. Bağlantı hattının hasarlı olması durumunda güç adaptörü artık kullanılmamalıdır.
14. Cihaz üzerinde tamirat ve müdahaleler ancak yetkili servis teknisyenleri tarafından gerçekleştirilebilir.

2.1 İşlev

Cihaz, 0,1 ml ila 200 ml hacim aralığında ve < 9,2 mm dış çapı olan bir emme borusu ile cam veya plastikten yapılmış ölçekli ve hacimsel pipetlerle sıvıların pipetlenmesine yarar. Doğru kullanımda pipetlenen sıvı sadece pipet ile temas eder.

2.2 Kullanım sınırları

Cihaz, aşağıdaki fiziksel sınırlar çerçevesinde sıvıların pipetlenmesine yarar:

- +10 °C ila +40 °C (50 °F ila 104 °F) (Cihaz ve reaktif)
- Buhar basıncı maks. 500 mbar'a kadar. Sıvının kaynamasının önlenmesi için 300 mbar'ın üzerinde yavaşça emdirin.
- Yoğunluk azami 9 g/cm³

2.3 Kullanım istisnaları

Cihaz, buharları aşındırıcı etkiye sahip olan veya silikon veya EPDM maddelerine karşı agresif etkisi olan sıvılar için kullanılamaz.

Cihaz pastör pipetleri ile kullanıma uygun değildir.

⚠ UYARI



Patlayıcı etkiye sahip ortamlarda cihaz çalıştırma

Cihaz, patlayıcı etkiye sahip ortamlarda çalıştırılmaz veya şarj edilemez. Kolay parlayabilen maddelerin pipetlenmesi yasaktır (Parlama noktası 0 °C (32 °F) altında örn. eter, aseton).

2.4 Depolama koşulları

Cihazı ve aksesuarlarını sadece temizlenmiş biçimde serin ve kuru ortamda muhafaza edin.

Depolama ısısı: -20 °C ila + 50 °C (-4 °F ila 122 °F).

Bağıl nem: %5 ila %95.

3 Fonksiyon ve işletim elemanları

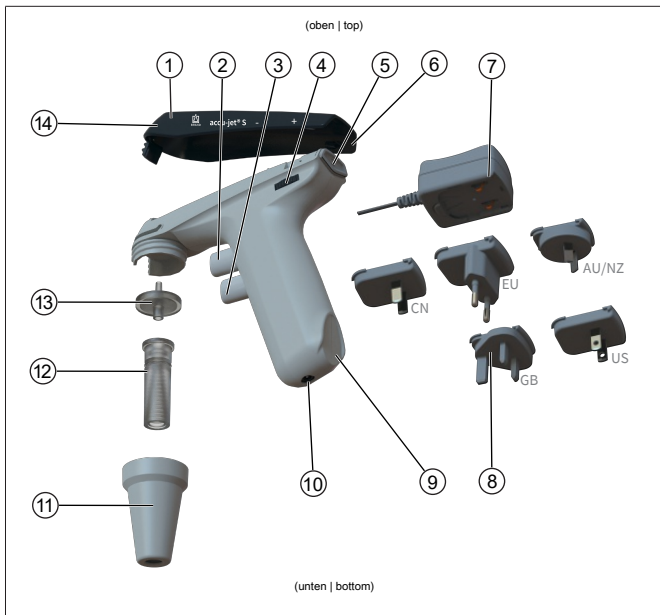

- | | | | |
|----|--|----|--------------------------------------|
| 1 | Gövde üst kabuğu (parçası) | 2 | Üst pipetleme düğmesi (sıvıyı çekme) |
| 3 | Alt pipetleme düğmesi (sıvıyı bırakma) | 4 | Motor devir sayısı için ayar çarkı |
| 5 | İşletim türü için seçim şalteri | 6 | Gövde üst kabuğu oturma yüzeyi |
| 7 | Güç adaptörü | 8 | Ülke adaptörü |
| 9 | Kulp oturma alanı | 10 | Şarj soketi |
| 11 | Adaptör gövdesi (PP) | 12 | Adaptör/Çek valf (SI/PTFE) |
| 13 | Membran filtre (PP/PTFE) | 14 | Basınç dengeleme açıklığı |

Gerilim ve güç tüketimi hakkındaki bilgiler için bakınız Teknik veriler, sayfa 532 .

Kısaltma	Malzeme
PP	Polipropilen

3 Fonksiyon ve işletim elemanları

Kısaltma	Malzeme
PTFE	Politetrafloroetilen
SI	Silikon

4 Çalıştırma

4.1 Bataryayı takma

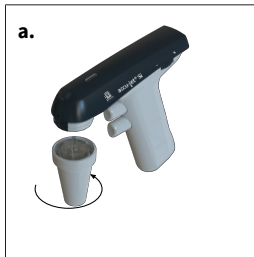

- a.** Batarya gövdesinin vidasını sökün. Adaptör ve filtre, adaptör gövdesinde kalır.

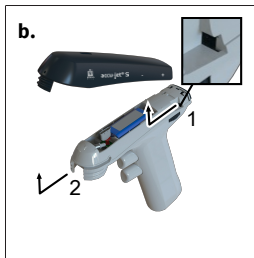

- b.** Gövdeyi çıkarın. Gövdeyi hafifçe adaptör gövdesinin vida bağlantısı yönünde itin.

⇒ Gövde, ayar çarkının (1) üst tarafındaki açıklıktan ve adaptör gövdesinin (2) vida bağlantısından çözülür.

⇒ Batarya bölmesi görünür.

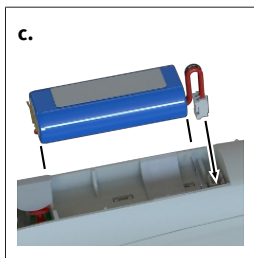

- c.** Batarya soketini kablosundan tutun, olması gerektiği şekilde hizalayın ve yerine oturduğuna kadar sıkıca sokete takın. Bataryayı yerleştirin.

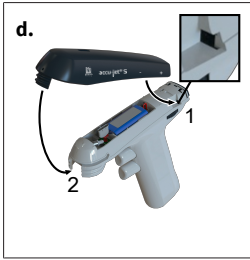

- d.** Gövdeyi takın. Gövdenin, ayar tekerinin üst kısmı (1) ve adaptör gövdesi vida yerindeki (2) ön görülen boşluklara oturmuş olduğuna dikkat edin.

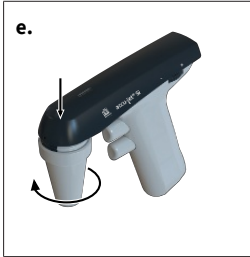

- e.** Gövde üst kısmını gövde kabuklarına bastırın ve adaptör gövdesini vidalayın.

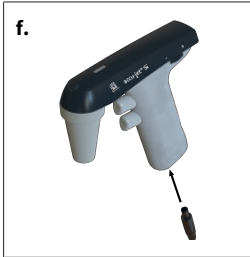

- f.** LED şarj göstergesi yeşil renkte yanıp sönene kadar bataryayı şarj edin. Şarj süresi yakl. 4 saat, bakınız Bataryanın şarj edilmesi.

4.2 Bataryanın şarj edilmesi

⚠ UYARI



Hasarlı güç adaptörü veya şarj kablosu

Elektrik çarpması nedeniyle yaralanma tehlikesi.



- > Hasarlı güç adaptörünü kullanmayın.
- > Şarj kablosu hasar görmüşse, güç adaptörünü kullanmayın.

DUYURU

Sadece üreticinin orijinal güç adaptörünü kullanın!

Başka bir güç adaptörünün kullanılması hem cihaza ve hem de bataryaya zarar verebilir.

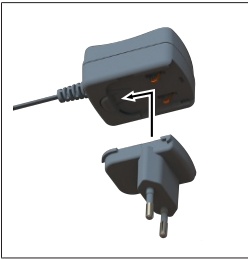

- a. Ülke adaptörünü güç adaptörüne takın.
 - b. Güç adaptörünü cihaza bağlayın.
 - c. Güç adaptörünü prize takın.
- ⇒ Cihaz şarj ediliyor. Bu, gövde üst kısmındaki LED şarj göstergesinden fark edilebilir. Çalışma süresi ve şarj süresi için bakınız Teknik veriler, sayfa 532 .

LED şarj göstergesi	Durum	Ne yapmalı?
Yeşil: yanıp sönüyor	Batarya şarj olmuş. Koruma şarjı yapılıyor.	Cihaz ile çalışabilirsiniz. Cihaz tamamen şarj olmuş.
Yeşil: sürekli yanıyor	Batarya şarj ediyor	Şarj işlemi sırasında da çalışmaya devam edebilirsiniz.
Kırmızı: yanıp sönüyor	Batarya neredeyse boş.	Cihaz ile faaliyetinize ara verin. Bataryayı şarj edin. Şarj işlemi sırasında da çalışmaya devam edebilirsiniz.
Kırmızı: sürekli yanıyor	Batarya boş.	Bataryayı şarj edin.

DUYURU

- Koruma şarjı, aşırı şarj edilmeyi önler ve Lazy-Battery etkisini minimize eder. Maksimum kapasitenin korunması için bataryayı ancak LED şarj göstergesi işaret verdiğinde şarj edin.

4.3 Cihazı başlatmak

Cihaz, şarj edilmiş bir batarya takıldığında çalışmaya hazırdır. Bir AÇMA/KAPAMA şalteri yoktur.

4.4 İşletim türünün seçilmesi

Seçim şalteri, bakınız Fonksiyon ve işletim elemanları, sayfa 517 .

İşletim türü “serbest akış”: Seçim şalterini yukarı doğru itin.

İşletim türü “motor destekli üfleme”: Seçim şalterini aşağı doğru itin.

4.5 Sıvı çekme veya bırakma

Pipetleme düğmesi, bakınız Fonksiyon ve işletim elemanları, sayfa 517

Pipetin doldurulması için üst pipetleme düğmesine ve bırakma için aşağıdaki pipetleme düğmesine basın.

4.6 Pipetleme hızının değiştirilmesi

Hız, ayarlanmış olan maksimum motor devir sayısı ile sınırlanmaktadır. Üst veya alt pipetleme düğmesine ne kadar fazla basılırsa, sıvı o kadar hızlı biçimde çekilir veya bırakılır.

4.7 Motor devir sayısını ayarlama

Ayar tekeri, bakınız Fonksiyon ve işletim elemanları, sayfa 517

Motor devir sayısı kademesiz olarak maksimumdan (+) minimuma (-) kadar, ayar tekerinin çevrilmesi ile ayarlanabilir. Büyük hacimli pipetler için maksimum motor devir sayısını ve küçük hacimli pipetler için daha düşük bir motor devir sayısını tavsiye ederiz.

4.8 Cihazın muhafaza edilmesi

4.8.1 Masa tutucusu

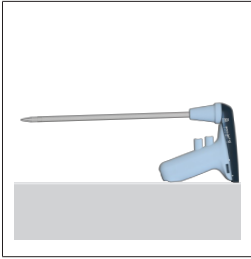

accu-jet® S düz zemine takılı pipet ile kullanılabilir.

4.8.2 Duvar desteği



- a.** Sabitleme yüzeyini uygun bir temizlik maddesi (nemlendiricili ev temizleyicisi değil) ve tüy bırakmayan bir bez ile temizleyin ve iyice kurumasını sağlayın.
- b.** Yapıştırma yüzeyinin koruma folyosunu çıkarın
- c.** Duvar tutucuyu **sıkıca** yapıştırılacak yüzeye bastırın.

5 Pipetleme

1. Pipeti takma

⚠ UYARI



Pipetin sıkıca oturduğuna dikkat edin. Asla şiddet uygulamayın! Özellikle ince pipetlerde cam kırılması riski vardır! Yaralanma tehlikesi!

1.



- a. Pipeti daima mümkün olduğunca üst ucundan tutun ve sıkıca oturana kadar, dikkatlice adaptöre ittin.
- b. Pipet takılmış olan cihazı daima ucu aşağı bakacak şekilde dik tutun.

2. Pipetin doldurulması

2.

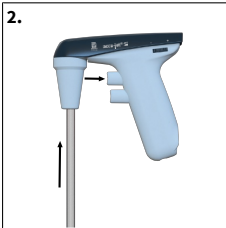

- a. Pipet ucunu sıvıya daldırın.
- b. Üstteki pipetleme düğmesine yavaşça basın ve pipeti, menisküsün istenilen işaretin biraz üzerinde kalacağı kadar doldurun.
- c. Her iki pipetleme düğmesine basıldığında, sıvıyı çok hassas bir şekilde çekebilir veya bırakabilirsiniz. Bu, özellikle menisküsü ayarladığınızda veya düşük hacimli pipetler kullandığınızda yardımcı olur.

DUYURU

Pipetleri aşırı doldurmayın.

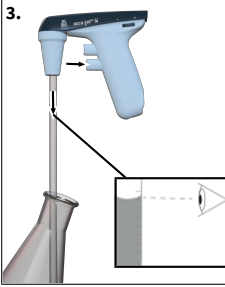
3. Hacmi ayarlama

- a.** Pipet ucunu gerektiğinde tüy bırakmayan uygun bir bez ile silin.
- b.** Alt pipetleme düğmesine yavaşça basın ve sıvıyı, menisküs ayarı tam istenilen ölçüye gelene kadar bırakın.

4. Pipeti boşaltma

- a.** Alt pipetleme düğmesine yavaşça basın. Pipetleme hızı, pipetleme düğmelerinin ne kadar derine bastırılmasına bağlıdır. Bu, “Motor destekli üfleme” işletim türünde, ayarlanmış olan motor devir hızına da bağlıdır.

5. Pipetlemeden sonra

- a.** Pipeti mümkün olduğunca üst kısımdan tutun ve adaptörden çekin.

6 Temizleme

DUYURU

accu-jet® S otoklav için uygun değildir

Gövde parçalarını arada bir nemli bir bez ile silin. Cihaz, amacına uygun olarak kullanıldığında, bakım gerektirmez.

6.1 Sızdırmazlığın kontrol edilmesi

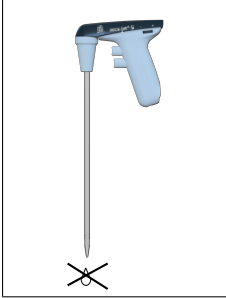

Menisküsün ayarlanmasından sonra, valflere basılmadan pipetten sıvı damlamamalıdır. Pipet damlatıyorsa, bakınız Arıza - Ne yapmalı?

6.2 Filtrenin değiştirilmesi ve adaptörün temizlenmesi

⚠ UYARI



Kontaminasyon ve enfeksiyon tehlikesi

Koruma eldivenleri ve göz koruması kullanın.



DUYURU

Filtre değişikliği veya temizliği sadece bir pipetin aşırı doldurulması veya emiş performansının azalmış olması durumunda gereklidir.

b.



a. Pipeti çıkarın.

b. Batarya gövdesinin vidasını sökün.

c. Üst gövdeyi çıkarın.

d.



d. Adaptör ve membran filtreyi, adaptör gövdesinin konik tarafından bastırarak çıkarın.

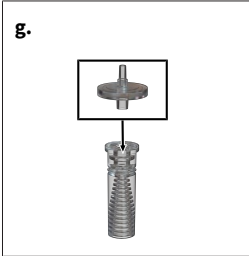
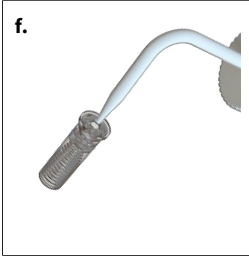
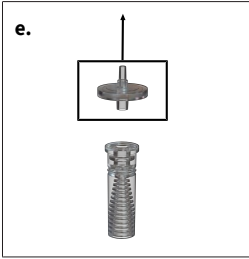

e. Arızalı membran filtreyi çıkarın.

f. Adaptörü temizlemek için uygun bir temizleme sıvısı, örneğin su ile doldurulmuş bir spreyci şişesiyle dikkatlice durulayın. Sonrasında sıvıyı üfleterek giderin ve kurutun.

g. Yeni membran filtreyi, önce daha kalın bağlantısı aşağı doğru olacak şekilde adaptörün içine bastırın (daha ince, konik olan taraf yuları doğru) ve adaptör gövdesine takın.



- h.** Gövde üst kısmını gövde kabuklarına bastırın ve adaptör gövdesini vidalayın.

DUYURU

Otoklavlanabilen filtreler hakkında bilgi

Otoklavlamanın etkinliğinin kullanıcının kendisi tarafından kontrol edilmesi gerekmektedir. Her membran filtre uygun değildir. Sadece orijinal aksesuar kullanın.

- > Cihaz seri olarak 0,2 µm membran filtre (kırmızı renk kodu) ile donatılmıştır.
- > Membran filtre beş defaya kadar 121 °C (250 °F) ile otoklavlanabilir.
- > 0,2 µm membran filtre (hücre kültürü için) ile B sınıfı hacim toleranslarına ulaşılabilir.
- > A sınıfı hacim toleranslarına ulaşılabilmesi için 3 µm membran filtreler gereklidir. Bunların, daha büyük gözenek genişlikleri nedeniyle pipetlerin serbest akış süreleri üzerinde daha düşük etkileri olmaktadır, bakınız .

6.3 UV Sterilizasyon

Cihaz, bir UV Sterilizasyon lambasının standart yoğunluğuna karşı dayanıklıdır. UV etkisi sonucunda bir renk değişikliği olması mümkündür.

7 Arıza - Ne yapmalı?





Arıza	Neden	Ne yapmalı?
Emiş performansı azalmış	Motor devir sayısı düşük	Motor devir sayısını yükseltin, bakınız Motor devir sayısını ayarlama, sayfa 523 .
	Çek valf kapalı	Seçim şalterini üflemeğe ayarlayın ve alt pipetleme düğmesine basın, bakınız İşletim türünün seçilmesi, sayfa 522
Pipet damlatıyor	Filtre doğru oturmuyor	Filtreyi doğru oturtun, bakınız Filtrenin değiştirilmesi ve adaptörün temizlenmesi, sayfa 528 .
	Adaptör veya pipet hasarlı	Adaptör veya pipeti değiştirin, bakınız Filtrenin değiştirilmesi ve adaptörün temizlenmesi, sayfa 528 .
Pipet adaptörde durmuyor	Adaptör kirlenmiş veya hasarlı	Adaptörü temizleyin, havayla kurutun gerektiğinde değiştirin, bakınız Filtrenin değiştirilmesi ve adaptörün temizlenmesi, sayfa 528 .
Güç adaptörü bağlandıktan ve gerilim beslemesi oluşturulduktan sonra LED şarj göstergesi yanıp sönmüyor.	Batarya soketi sıkıca yerine takılmamış	Bataryayı sıkıca yerine takın, bakınız Bataryayı takma, sayfa 519 .
	Yanlış güç adaptörü	Sadece orijinal güç adaptörünü kullanın, bakınız Fonksiyon ve işletim elemanları, sayfa 517
	Batarya veya güç adaptörü arızalı	Batarya/güç adaptörünü değiştirin
	Cihaz arızalı	Cihazı tamir için gönderin, bakınız Onarım, sayfa 533
Düşük batarya kapasitesi	Batarya arızalı	Bataryayı değiştirin, bakınız Bataryayı takma, sayfa 519 .
Cihaz herhangi bir fonksiyon yapmıyor	Dahili hata (Reset gerçekleştirin)	Batarya soketini gevşetin ve bir pipetleme düğmesini 10 saniye boyunca basılı tutun. Batarya soketini yeniden sıkıca takın, bakınız Bataryayı takma, sayfa 519 ve Pipetleme, sayfa 525

Sorunu yukarıdaki arıza tablosu yardımıyla çözemerseniz, yetkili satıcınıza veya doğrudan üreticiye başvurun.

8 Teknik veriler

Teknik veriler	Değerler
Şarj soketi	5 VDC
Güç adaptörü	Input: 100 – 240 VAC, 50/60 Hz Output: 5 VDC
Batarya	Akku-Pack NiMH 2,4 V, 730 mAh Şarj süresi: 4 s Maksimum çalışma süresi: yakl. 8 s Şarj ısısı: +10 °C ila +35 °C

8.1 Ürün üzerinde işaretleme

İşaret veya rakam	Anlamı
XXZXXXXX	Seri numarası
Quick Response Kodu	Seri numarasını içerir
	Bu işaret ile ürünün EG yönergeleri ile belirlenmiş olan gerekliliklere uygun olduğunu ve belirlenmiş olan test işleminden geçtiğini teyit ederiz.
	UKCA: United Kingdom Conformity Assessed Bu işaret ile ürünün UK Designated Standards ile belirlenmiş olan gerekliliklere uygun olduğunu teyit ederiz.
www.brand.de/ip	Patent bilgileri
 (burada: 40 Yıl)	China RoHS (EFUP) EFUP, elektrikli ve elektronik cihazlarda bulunan tehlikeli maddelerin normal işletme şartları altında sızması veya değişmemesi ile ilgili zaman süresini tanımlar. Bu tür elektrikli ve elektronik cihazlar, kullanıcılar tarafından normal biçimde kullanıldıklarında, ağır çevre kirliliklerine veya ağır bedensel yaralanmalara veya kullanıcının maddi değerlerinin hasar görmesine neden olmaz.
	Bu elektrikli cihazın evsel atıklar ile bertaraf edilmesi yasaktır.

9 Onarım

9.1 Onarım için gönderme

DUYURU

Tehlikeli maddelerin izin alınmadan nakliyesi kanunla yasaklanmıştır.

Cihazı iyice temizleyin ve dekontamine edin!

- Ürünlerin geri gönderilmesi durumunda temel olarak arızanın kesin bir tarifi ve türü ile kullanılan malzemeler hakkındaki bilgiyi ekleyin. Kullanılan malzemeler konusundaki bilginin eksik olması durumunda cihaz tamir edilemez.
- Cihazı sadece batarya veya pil olmadan gönderin.
- İade nakliyesinin riski ve masrafı göndericiye aittir.

ABD ve Kanada haricinde

“Sağlık güvenliği beyanını” doldurun ve cihaz ile birlikte üretici veya satıcıya gönderin. Taslak basımlar satıcı veya üreticiden talep edilebilir veya www.brand.de altında indirilmeye hazırdır.

ABD ve Kanada dahilinde

Cihazı servis için göndermeden **önce** BrandTech Scientific, Inc. ile geri gönderim şartlarını görüşün.

İade gönderimi numarası ile birlikte size verilmiş olan adrese sadece temizlenmiş ve dekontamine edilmiş cihazları gönderin. Geri gönderim numarasını dışarıdan iyi görünecek bir şekilde ürünün üzerine yerleştirin.

İletişim adresleri

Almanya:

BRAND GMBH + CO KG
Otto-Schott-Straße 25
97877 Wertheim (Almanya)
T +49 9342 808 0
F +49 9342 808 98000
info@brand.de
www.brand.de

ABD ve Kanada:

BrandTech® Scientific, Inc.
11 Bokum Road
Essex, CT 06426-1506 (ABD)
T +1-860-767 2562
F +1-860-767 2563
info@brandtech.com
www.brandtech.com

Hindistan:

BRAND Scientific Equipment Pvt. Ltd.
303, 3rd Floor, 'C' Wing, Delphi
Hiranandani Business Park,
Powai
Mumbai-400 076 (Hindistan)
T +91 22 42957790
F +91 22 42957791
info@brand.co.in
www.brand.co.in

Çin:

BRAND (Shanghai) Trading Co., Ltd.
Guangqi Culture Plaza
Room 506, Building B
No. 2899, Xietu Road
Shanghai 200030 (Çin Halk Cumhuriyeti)
T +86 21 6422 2318
F +86 21 6422 2268
info@brand.com.cn
www.brand.cn.com

10 Sipariş bilgileri

10.1 Cihaz

Cihaz üst gövdesi rengi	Sipariş No. (Genel güç adaptörü ve ülke adaptörü ile birlikte)	Sipariş No. (Genel ülke adaptörü ve ülke adaptörü hariç)
Antrasit	26350	26360
Dut	26351	26361
Petrol	26352	26362
Ametist	26353	26363

Teslimat kapsamı, bakınız . Güç adaptörü içeren ve içermeyen sipariş numaralarını dikkate alın.

10.2 Yedek parçalar

Yedek membran filtre

Tanım	Ambalaj birimi	Sipariş No.
0,2 µm, steril (kırmızı renk kodu)	1 Ad. Blister ambalajda	26530
0,2 µm	10 ad PE poşette	26535
3 µm	1 Ad. Blister ambalajda	26052
3 µm	10 ad PE poşette	26056

Güç adaptörü

Güç adaptörü teknik verileri, bakınız Teknik veriler, sayfa 532 .

Tip	Sipariş No.
Güç adaptörü ülke adaptörü ile birlikte	26606

Batarya seti

Batarya hakkındaki teknik veriler, bakınız Teknik veriler, sayfa 532 .

Tanım	Sipariş No.
Akkupack NiMH	26630

Çek valfli silikon adaptör

Tanım	Sipariş No.
Silikon adaptör	26508

Adaptör gövdesi

Renk	Sipariş No.
beyaz	26658

Duvar desteği

Renk	Sipariş No.
beyaz	26539

Yapıştırma bantı

Ambalaj Birim	Sipariş No.
3 Set	26547

11 Kusur sorumluluğu

Cihazın amacına uygun olmayan işlem, kullanım, bakım veya işletmesi veya yetkisiz tamiri veya özellikle pistonlar, contalar, valfler gibi aşınır parçaların normal yıpranması veya cam kırılmasına karşı sorumluluk üstlenmeyiz. Aynıısı kullanım kılavuzunun dikkate alınmaması için de geçerlidir. Özellikle cihazın kullanım kılavuzunda tanımlanmış olandan daha fazla sökülmesi durumunda veya yabancı aksesuar veya yedek parçaların monte edilmiş olması durumunda sorumluluk üstlenmeyiz.

ABD ve Kanada:

Kusur sorumluluğu hakkındaki bilgileri www.brandtech.com adresinde bulabilirsiniz.

12 Bertaraf etme



Yandaki sembol, pillerin/bataryaların ve elektronik cihazların, kullanım ömürlerinin sonunda evsel atıklardan (ayrıştırılmamış yerleşim yeri atıkları) ayrı olarak bertaraf edilmesi gerektiğini göstermektedir.

Elektronik cihazların, Avrupa Parlamentosu Direktif 2012/19/EU ve Konseyin 4 Temmuz 2012 tarihli elektrikli ve elektronik eski cihazlar ile ilgili yönergesine istinaden, yerel bertaraf yönetmeliklerine uygun olarak profesyonel biçimde bertaraf edilmesi gerekmektedir.

Piller ve bataryalar, çevreye ve insan sağlığına zararlı etkisi olabilecek olan maddeler içermektedir. Bunların bu nedenle, Avrupa Parlamentosu Direktif 2006/66/EG ve Konseyin 6 Eylül 2006 tarihli Piller ve Akümülatörler ile ilgili yönergesine istinaden, yerel bertaraf yönetmeliklerine uygun olarak profesyonel biçimde bertaraf edilmesi gerekmektedir. Sadece tamamen boşaltılmış pil ve bataryaları bertaraf edin.

