

Operating Instructions

Original Operating Instructions

Picus[®] 2

LH-747021 | LH-747041 | LH-747061 | LH-747081 | LH-747101 | LH-747111 | LH-747321 | LH-747341 | LH-747361 |
LH-747391 | LH-747421 | LH-747441 | LH-747461 | LH-747491

Electronic Pipette



1000125943



SARTORIUS

Contents

1	About This Manual	5	4.9	List of Parameters	23
1.1	Validity	5	4.9.1	Parameters in the "Advanced Functions" Menu	23
1.2	Supporting Documents	5	4.9.2	Parameters in the "Settings"/"Languages" Menu	24
1.3	Target Groups	5	4.9.3	Parameters in the "Settings"/"Theme" Menu	24
1.4	Symbols Used	6	4.9.4	Parameters in the "Settings"/"Bluetooth" Menu	24
1.4.1	Warnings in Operation Descriptions	6	4.9.5	Parameters in the "Settings"/"Password" Menu	24
1.4.2	Other Symbols Used	6	4.9.6	Parameters in the "Settings"/"Sound" Menu	25
2	Safety Instructions	7	4.9.7	Parameters in the "Settings"/"Backlight" Menu	25
2.1	Intended Use	7	4.9.8	Parameters in the "Settings"/"Date & time" Menu	25
2.1.1	Modifications to the Device	7	4.9.9	Parameters in the "Settings"/"Tip Ejection" Menu	25
2.2	Qualifications of Personnel	7	4.9.10	Parameters in the "Settings"/"Adjustment" Menu	26
2.3	Functional Capability of the Device Parts	7	4.9.11	Parameters in the "Settings"/"User ID" Menu	26
2.4	Electrical Equipment	8	4.9.12	Parameters in the "Settings"/"Reminder" Menu	26
2.4.1	Damage to the Electrical Equipment of the Device	8	4.9.13	"Settings"/"Reset" Menu	27
2.5	Risk of Injury During Continuous Pipetting	8	5	Installation	28
3	Device Description	9	5.1	Scope of Delivery	28
3.1	Device Overview	9	5.2	Unpacking	28
3.2	Controls and Connection	10	5.3	Acclimatization	28
3.3	Pipette Tips and Safe-Cone Filters	11	5.4	Inserting a Safe-Cone Filter	28
3.4	Sartorius Mobile App	12	6	Commissioning	29
3.5	Symbols on the Device and on the Package	12	6.1	Clean the Device	29
4	Operating Design	13	6.2	Charging the Device	29
4.1	Controls	13	6.2.1	Charging with the Charging Carousel or Charging Stand	29
4.2	Operating Mode Display	14	6.2.2	Charging with the USB Charger	29
4.2.1	Displays in Menus	15	6.3	Switching the Device On or Off	30
4.3	Messages	16	6.3.1	Returning to Active Mode	30
4.3.1	Function of the Softkeys	16	6.4	Rinsing Tips	30
4.4	Indicators in the Display	17			
4.5	Navigating in Menus	18			
4.5.1	Menus in the Device	20			
4.6	Menu Structure in the Main Menu	20			
4.6.1	Menu Structure in the "Settings" Sub-menu	21			
4.7	Menu Structure in the "Advanced Functions" Menu	22			
4.8	Menu Structure in the "Memory Places" Menu	22			

7 System Settings	31	13 Disposal	51
7.1 Setting Defaults	31	13.1 Disposing of the Device and Parts	51
7.2 Connecting the Device to the Sartorius Pipetting Mobile App	31	14 Technical Data	52
7.3 Managing User Data	32	14.1 Dimensions and Weights	52
7.3.1 Creating a User ID	32	14.1.1 1-channel models	52
7.3.2 Activating Password Protection	32	14.1.2 Multi-channel models with 8	52
7.3.3 Logging Into or Out of the Device	33	14.1.3 Multi-channel models with 12	52
7.3.4 Deactivating Password Protection	33	14.2 Ambient Conditions	53
7.4 Adjusting the Device	34	14.3 Electrical Data	53
7.4.1 Activating the Adjustment Setting	36	14.3.1 Power Supply	53
7.5 Setting Up Reminders	36	14.3.2 Safety of Electrical Equipment	54
7.5.1 Deactivating Reminders	37	14.3.3 Safety and Electromagnetic Compatibility	54
8 Operation	38	14.4 Interfaces	54
8.1 Using Operating Modes (Examples).....	38	14.5 Operating Modes with Advanced Functions	55
8.1.1 Multi Dispensing	38	14.6 Acceleration Sensor	55
8.1.2 Manual Pipetting	38	14.7 RFID Tag	55
8.2 Locking and Unlocking the Device	39	14.8 Materials	56
8.2.1 Activating the Device Lock	39	14.9 Cleaning Agents and Cleaning Methods	57
8.2.2 Opening the Device Lock	39	14.9.1 Cleaning Agents	57
9 Cleaning and Maintenance	40	14.9.2 Cleaning Methods	57
9.1 Cleaning the Outer Surface of the Device	40	14.10 Battery	57
9.2 Cleaning the Lower Assembly of the Device	40	14.11 Z Scores (μl /mg) for Performance Review	58
9.2.1 Removing the Safe-Cone Filter	41	14.12 Performance Specification	59
9.2.2 Dismantling the Lower Assembly (1-channel Models)	41	14.12.1 Models LH-747021 LH-747041 LH-747061 LH-747081 LH-747101 LH-747111	59
9.2.3 Cleaning Individual Components (1-channel Models)	42	14.12.2 Models LH-747321 LH-747341 LH-747361 LH-747391 LH-747421 LH-747441 LH-747461 LH-747491	61
9.2.4 Assembling the Lower Section (1-channel Models)	43	14.13 Speed Table	62
9.3 Sterilising the Lower Assembly	44	14.13.1 1-channel Pipette	62
9.3.1 Autoclaving	44	14.13.2 Multi-channel Pipette	62
9.4 Performance Check	45	15 Accessories and Consumables	63
9.4.1 Weighing	45	15.1 Accessories	63
9.5 Maintenance Schedule	46	15.2 Consumables	63
9.6 Greasing Components (1-channel models)	46	16 Sartorius Service	64
9.7 Performing a Software Update	47	17 Documents on Conformity	65
10 Trouble	48	18 Trademark Information	67
10.1 Troubleshooting	48	18.1 Bluetooth®	67
10.2 Resetting to Defaults	49		
11 Decommissioning	50		
11.1 Decommissioning the Device	50		
12 Storage and Shipping	50		
12.1 Storage	50		
12.2 Returning the Device and Parts	50		

1 About This Manual

1.1 Validity

This manual is part of the device and must be read in full and kept safe. The manual applies to the following versions of the device:

Device	Item number
Picus 2 electronic pipette, 1-channel model	
0.2 -10 μL	LH-747021
5 -120 μL	LH-747041
10-300 μL	LH-747061
50-1000 μL	LH-747081
100-5000 μL	LH-747101
500-10000 μL	LH-747111
Picus 2 electronic pipette, 8-channel model	
0.2 -10 μL	LH-747321
5 -120 μL	LH-747341
10-300 μL	LH-747361
50-1200 μL	LH-747391
Picus 2 electronic pipette, 12-channel model	
0.2 -10 μL	LH-747421
5 -120 μL	LH-747441
10-300 μL	LH-747461
50-1200 μL	LH-747491

1.2 Supporting Documents

- ▶ In addition to this manual, please note the following documentation:
 - Instructions for the consumables, accessories, e.g. pipette stands, pipette tips

1.3 Target Groups

This manual is aimed at the following target groups. The target groups must have the specified knowledge.

Target group	Knowledge and qualifications
Operator	The operator is familiar with the device and the associated work processes. The operator is aware of the dangers that can occur when working with the device, and can avoid these dangers.*
Administrator	The administrator is responsible for integrating the device into the production process. The administrator ensures reliable operation of the system and device software.*

* When a person from the target group operates the software interface of the device, they are simultaneously a "user".

1.4 Symbols Used

1.4.1 Warnings in Operation Descriptions

CAUTION

Identifies a hazard that can result in moderate or minor injuries if **not** avoided.

1.4.2 Other Symbols Used

- ▶ Action: describes activities that must be executed. The activities in action sequences must be executed in consecutive order.
- ▷ Result: describes the result of the activities executed.
- [] Refers to controls and display elements. Identifies status messages, warning messages and error messages.

Illustrations in this manual

Depending on the device configuration, the illustrations of the device and user display may differ slightly from the supplied device. The variants shown in this manual are examples.

2 Safety Instructions

2.1 Intended Use

The Picus® 2 pipette is a general purpose laboratory device. The device is intended, designed and manufactured for dispensing liquids in a variety of applications, and to be used in combination with Sartorius Optifit Tips or Safetyspace® Filter Tips. The product range of the device covers a volume range of 0.2 µl to 10,000 µl.

The tips are designed for single use and must be disposed of after being used once.

The device is exclusively intended for use in accordance with these instructions. Any other use is considered **unintended** use.

Usage conditions for the device

Do **not** use the device in potentially explosive environments. Only use the device indoors.

Only use the device with the equipment and under the operating conditions described in the technical data in this manual.

2.1.1 Modifications to the Device

If the device is modified: people could be put at risk. Device-specific documents and product approvals could lose their validity.

If you have any queries regarding modifications to the device, please contact Sartorius.

2.2 Qualifications of Personnel

People without adequate knowledge of how to handle the device safely could injure themselves and others.

If a specific qualification is required for an activity: the target group is specified. If **no** qualification is specified: the activity can be executed by the "Operator" target group.

2.3 Functional Capability of the Device Parts

Device parts that are **not** functional, e.g. due to damage or wear, can cause malfunctions. This could cause injury to people.

► If device parts are **not** functional: do **not** use the device.

2.4 Electrical Equipment

2.4.1 Damage to the Electrical Equipment of the Device

Damage to the electrical equipment of the device, e.g. damage to the insulation, can lead to unforeseeable hazards.

- ▶ If there are defects in the electrical equipment, disconnect the device from the power supply and contact Sartorius Service.
- ▶ Keep moisture away from live parts. The moisture can cause short circuits.

2.5 Risk of Injury During Continuous Pipetting

An unsuitable posture during pipetting, or using the device without taking breaks, can result in musculoskeletal disorders or repetitive strain injury (RSI) to the hand.

- ▶ When pipetting, take regular breaks and relax your hand.
- ▶ When pipetting, stand or sit upright.
- ▶ Place your index finger under the hook and operate the device with your thumb.
- ▶ Do **not** tense up while pipetting.

3 Device Description

3.1 Device Overview

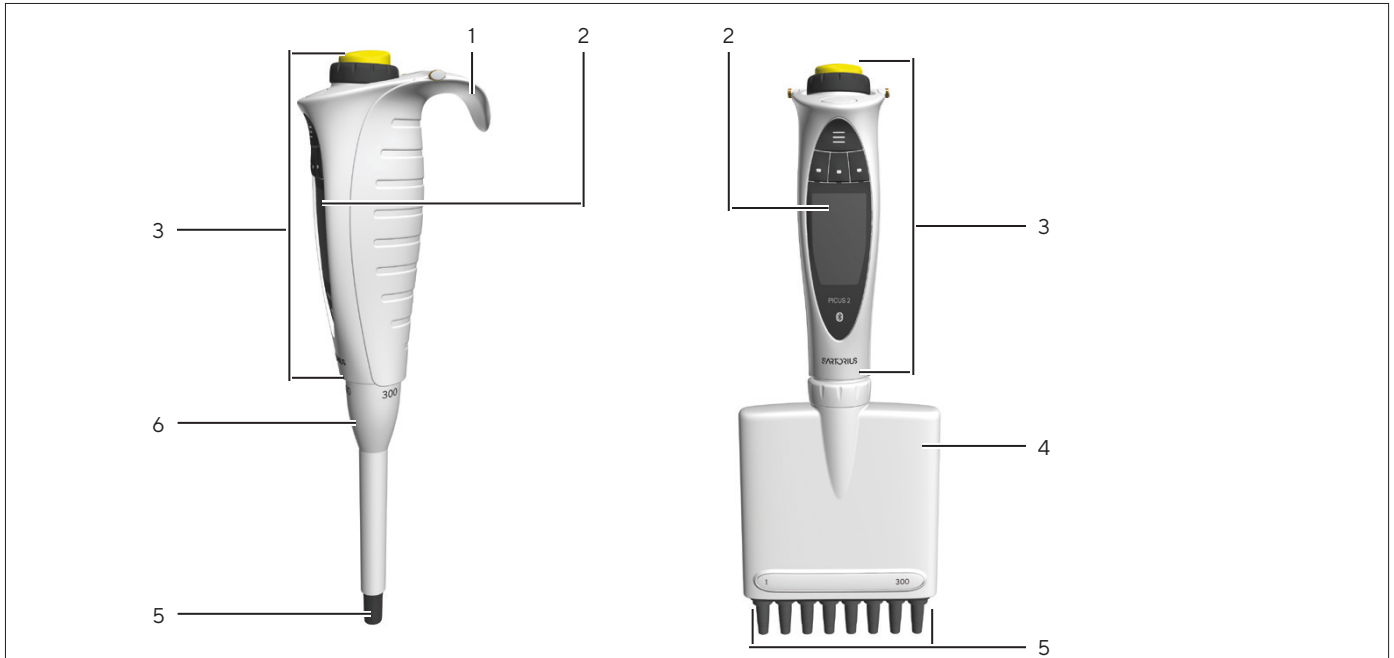

Fig. 1: 1-channel model and multi-channel model (example)

Pos.	Name	Description
1	Finger Hook	For resting the device on your finger.
2	User display	Displays all the relevant information.
3	Control head	To control the device and trigger individual pipetting steps
4	Dispensing head	Consists of: <ul style="list-style-type: none"> – Piston – Cylinder – Tip cone – Tip ejection system
5	Tip Cone(s)	<ul style="list-style-type: none"> – For attaching tips – Optiload system to load tips evenly (only for multichannel models)
6	Ejection sleeve	<ul style="list-style-type: none"> – Electronically ejects the tip(s). – With 1-channel models: Height-adjustable – Contains the specification of the maximum volume.

3.2 Controls and Connection

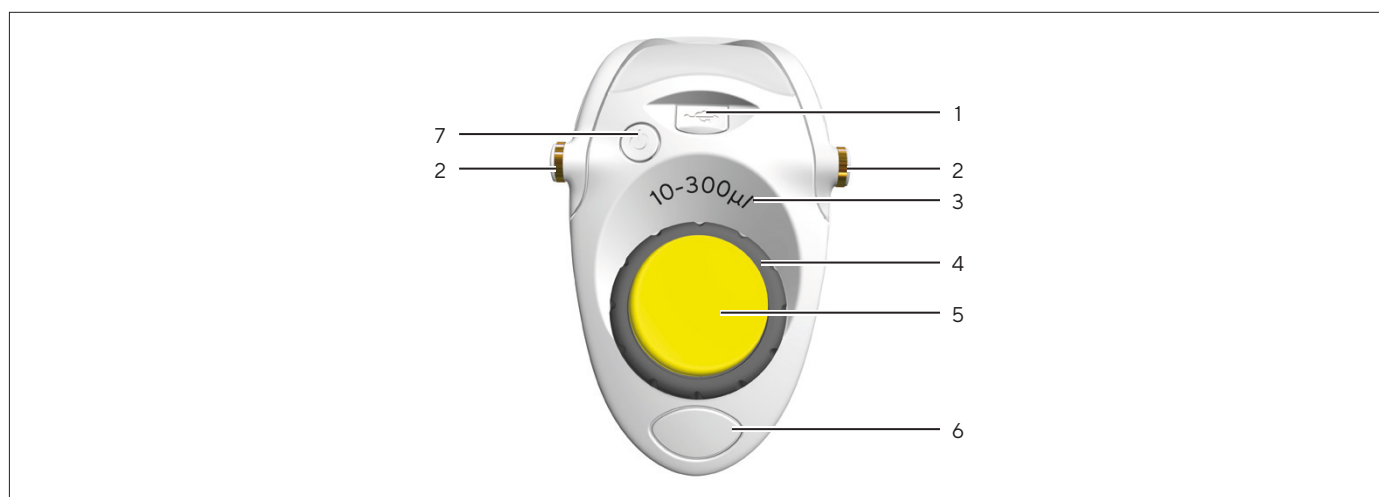

Fig.2: Controls and connection (example)

Pos.	Name	Description
1	Micro USB port	For connection to the mains plug or a to PC
2	Charging contact	Is intended to charge the device with the charging stand or carousel.
3	Volume range	Indicates the volume range.
4	Scrollwheel	<ul style="list-style-type: none"> – Allows you to scroll through menus and set values. – Controls the aspiration and dispensing of liquids in manual pipetting mode.
5	Operating button	<ul style="list-style-type: none"> – Used to confirm settings and trigger the piston movement during aspiration, dispensing and repeated blow-out. – The colour indicates the volume range (for the colour of the operating button, see Chapter “14.12 Performance Specification”, page 59).
6	Electronic tip ejection	Is intended to eject the tip.
7	On Off button	For switching the device on or off

3.3 Pipette Tips and Safe-Cone Filters

The pipette tip must be adapted to the volume range of the device and the degree of purity. The colour of the operating button and the colour of the tip trays must match. We recommend using Sartorius Optifit Tips or Safetyspace® Filter Tips. The use of Safe-Cone Filters or Safetyspace® Filter Tips helps to prevent contamination of the device. Safe-cone filters are replacable and can be used together with Optifit tips. Safe-Cone filters are inserted in pipette tip cones.

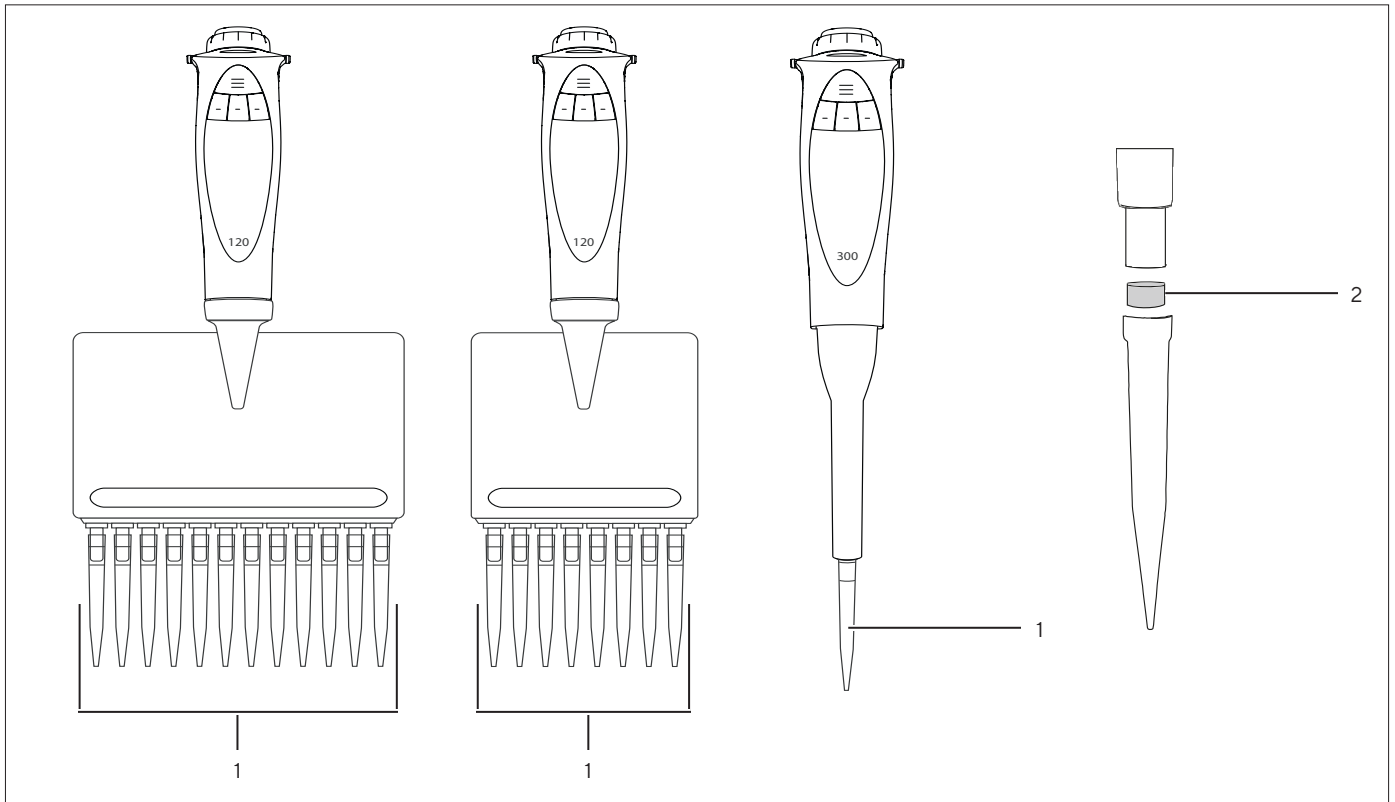

Fig. 3: Pipette tips on multi-channel models and 1-channel model and Safe-Cone-Filter (example)







Pos.	Name	Description
1	Pipette tips	Serve to aspirate and dispense liquids.
2	Safe-Cone-Filter	<ul style="list-style-type: none"> – Helps prevent liquids from contaminating the device. – Available separately for models over 10 µl

3.4 Sartorius Mobile App

The device can also be used with companion app. In the app you will have multiple options to speed up your routine workflows and customize your pipettes. The app can also be used to perform device updates. The app is available at App store and Play store.

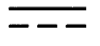

3.5 Symbols on the Device and on the Package

Symbol	Meaning
	Bluetooth® symbol: Indicates that a Bluetooth connection can be established with this device.
	Autoclaving symbol: Component is autoclavable.
	The device complies with applicable EU directives and standard.
	The device complies with applicable UK legislation and standards.
	Separate collection of electronic equipment
	Direct current
 R 210-108944	GITEKI symbol: The device complies with the standards and regulations of the Japanese Radio Law.

4 Operating Design

4.1 Controls

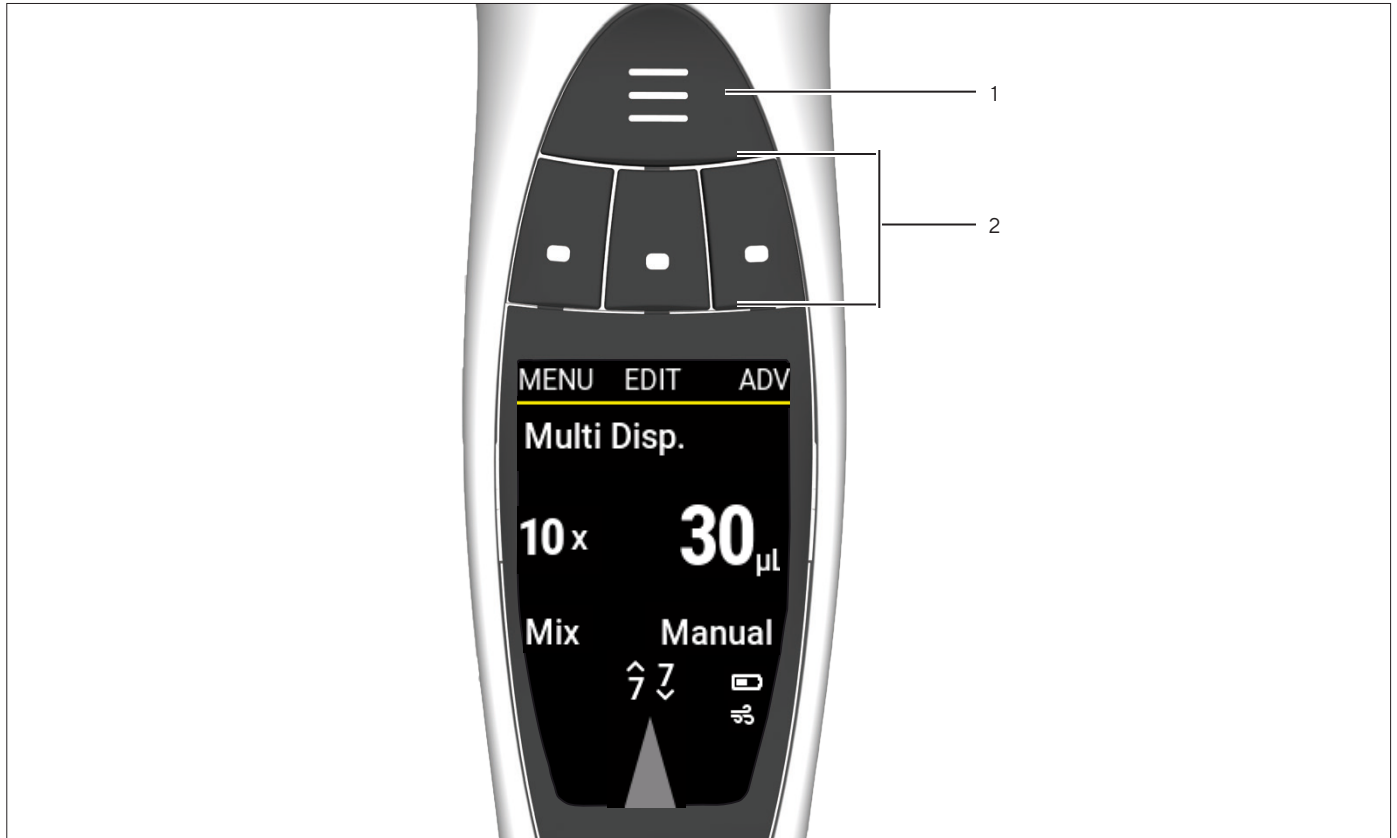

Fig. 4: Controls on the device

Pos.	Name	Description
1	Hotkey	Save and activate frequently used or favorite pipette settings.
2	Softkeys	<ul style="list-style-type: none"> – For controlling the device. – The functions of the individual keys vary according to the display.

4.2 Operating Mode Display

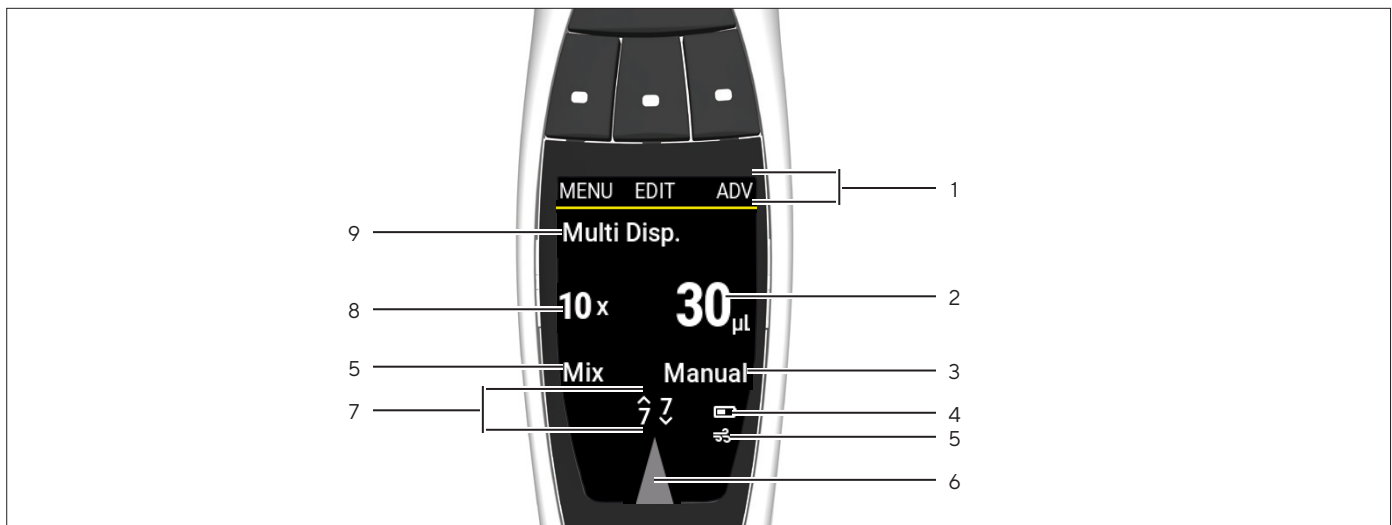

Fig. 5: Operating mode display (example)

Pos.	Name	Description
1	Softkey function	Indicates which function is assigned to the overlying softkey.
2	Pipetting volume	<ul style="list-style-type: none"> – Indicates what volumes are being taken up or dispensed.. – In Multi Dispense mode: Indicates partial volumes dispensed per dispensing process.
3	Advanced functions property	Adjustable parameters for the advanced functions. Value and unit vary according to the activated advanced function.
4	Battery indicator	Displays the battery level.
5	Advanced functions indicator	Displays the activated advanced function.
6	Aspirate dispense display arrow	<ul style="list-style-type: none"> – If the tip is pointing up: the device is set up to aspirate – If the tip is pointing down: the device is set up to dispense.
7	Speed	Indicates the speed with which the device aspirates or dispenses.
8	Pipetting activity number	Indicates how often aspiration dispensing is carried out in the current operating mode. This parameter is only available in the multi-dispensing, sequentiell dispensing and multi-aspiration operating modes.
9	Operating mode	Indicates the selected operating mode.

4.2.1 Displays in Menu

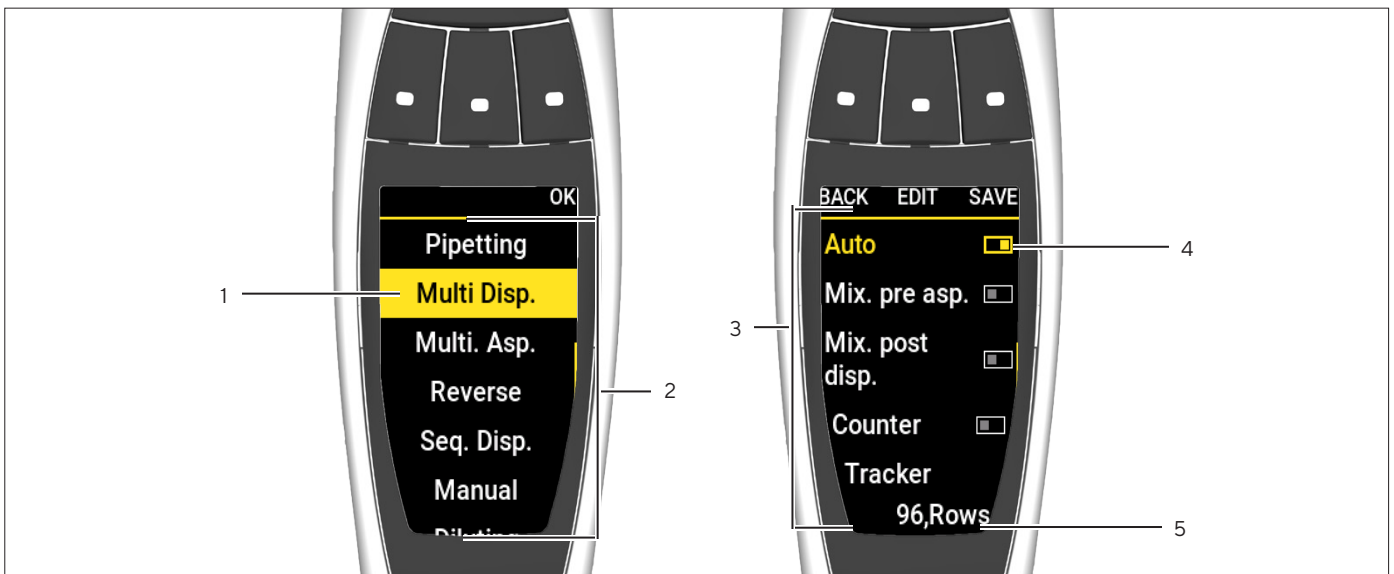

Fig. 6: Displays in menus (example)

Pos.	Name	Description
1	Menu entry	Yellow background: Currently selected.
2	Main menu	Contains available operating modes and settings menu.
3	Advanced functions	Number and type of advanced functions. The number varies according to the activated operating mode.
4	On Off bar	<ul style="list-style-type: none"> – If the dark bar is on the right: the function is activated. – If the dark bar is on the left: the function is deactivated.
5	Selection parameters	Are Predefined and selectable with the scrollwheel.

4.3 Messages

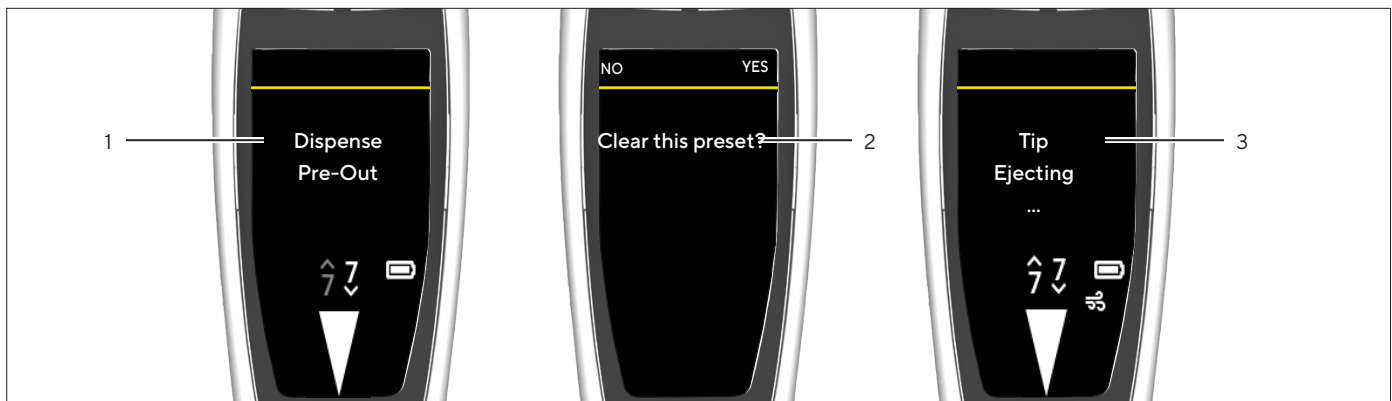





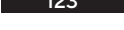



Fig.7: Messages (example)











Pos.	Name	Description
1	Prompt	<ul style="list-style-type: none"> Shows what the device will do next. Initiation via the operating button is required.
2	Query	<ul style="list-style-type: none"> Shows the operator options. The selection is made using the softkeys.
3	Notification	<ul style="list-style-type: none"> Shows what the device is doing. No action by the operator is required.

4.3.1 Function of the Softkeys

Symbol	Designation	Description
MENU	[MENU] softkey	Opens the main menu.
ADV	[ADV] softkey	Opens the window with the available advanced functions.
EDIT	[EDIT] softkey	Activates edit mode.
OK	[OK] softkey	<ul style="list-style-type: none"> In the menu: Opens the selected menu entry. In edit mode: Applies the selection. For advanced functions: <ul style="list-style-type: none"> Opens parameter entries Activates edit mode Returns to the menu
BACK	[BACK] softkey	Returns to the previous display.
Pick	[Pick] softkey	Selects the current entry.
NEXT	[NEXT] softkey	Skips to the next parameter.
END	[END] softkey	Cancels the pipetting process.
SAVE	[SAVE] softkey	Saves the current program at the selected memory place.
RESET	[RESET] softkey	Resets the date and cycle counter.

Symbol	Designation	Description
	[NO] softkey	<ul style="list-style-type: none"> – Does not apply the changes. – Does not execute the action.
	[YES] softkey	<ul style="list-style-type: none"> – Applies the changes. – Does execute the action.
	[PREV] softkey	With activated protocol: returns to the previous protocol step.
	[NEXT] softkey	With activated protocol: skips to the next protocol step.
	[ABC] softkey	<ul style="list-style-type: none"> – Indicates that upper case is activated. – With softkey pressed: switches to [abc] function.
	[abc] softkey	<ul style="list-style-type: none"> – Indicates that lower case is activated. – With softkey pressed: switches to [123] function.
	[123] softkey	<ul style="list-style-type: none"> – Indicates that numbers are activated. – With softkey pressed: switches to [#@!] function.
	[#@!] softkey	<ul style="list-style-type: none"> – Indicates that special characters are activated. – With softkey pressed: switches to [CLEAR] function.
	[CLEAR] softkey	<ul style="list-style-type: none"> – Deletes the text. – With softkey pressed: switches to [ABC] function

4.4 Indicators in the Display

Symbol	Designation	Description
	Indicator [Charge status]	<ul style="list-style-type: none"> – Shows the current charge status of the device. – If the battery level is low: the indicator flashes.
	Indicator [Indicator arrow]	Indicates which pipetting process is selected: aspirate or dispense.
	Indicator [Dispensing speed]	Shows the dispensing speed.
	Indicator [Aspiration speed]	Shows the aspiration speed.
	Indicator [Blowout]	Shows that the additional function [Blowout] is activated.
	Indicator [Bluetooth]	Shows that Bluetooth is activated.
	Indicator [Counter]	Shows that the additional function [Counter] is activated.
	Indicator [Plate Tracker]	Shows that the additional function [Plate Tracker] is activated.
	Indicator [Mix]	Shows that the additional function [Mix. pre. asp.] and/or [Mix. post disp] is activated.
	Indicator [Delay]	Shows that the additional function [Auto] is activated.

4.5 Navigating in Menus

Procedure

MENU

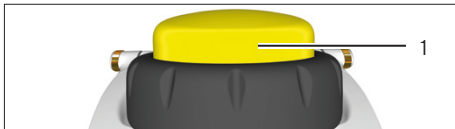
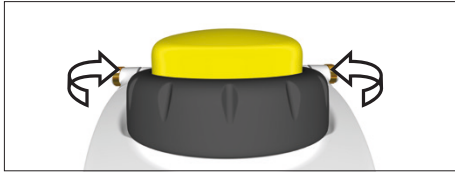

EDIT

NEXT

BACK

ABORT

ADV



OK

SAVE

- ▶ To call up the main menu: press the [MENU] softkey.
- ▶ When scrolling in menus: turn the scrollwheel in the desired direction.
 - Anti-clockwise: scroll down.
 - Clockwise: scroll up.
- ▶ To select a menu option or save settings:
 - ▶ Press the operating button (1) or the [OK] softkey.
- ▶ To activate edit mode for the pipetting settings: use one of the following options:
 - ▶ Turn the scrollwheel as far as it will go in one direction.
 - ▶ Press the [EDIT] softkey.
- ▷ Edit mode is activated.
- ▶ To change a parameter: turn the scrollwheel in the desired direction:
 - Anti-clockwise: increase the value or activate the functions.
 - Turn clockwise: reduce the value or deactivate the functions.
- ▶ To apply the changes in edit mode and switch to the next parameter: press the [NEXT] softkey.
- ▷ The next parameter is activated for editing. If there are **no** more parameters, the cursor returns to the first parameter.
- ▶ To return to the next highest menu level or to exit applications without saving: Press the [BACK] softkey.
- ▶ To trigger the piston movement for aspiration, dispensing and repeated blow-out: press the operating button.
- ▶ To move the piston in manual and titration mode for aspiration and titration: Turn the scrollwheel.
- ▶ To cancel a mixing operation prematurely: Press the [ABORT] softkey.
- ▶ To call up the advanced functions menu (only possible from a operating mode): press the [ADV] softkey.
- ▶ To open the list of memory places (only possible from an operating mode): press the hotkey.
- ▶ To activate a saved program: Press the [OK] softkey.
- ▶ To save the current program At the selected memory slot press the [SAVE] softkey.

Text input

- ▶ When entering text, navigate between the positions, e.g. to create the user ID:
 - ▶ In view mode: For one position to the left, turn the scrollwheel anticlockwise, and for one position to the right, turn the scrollwheel clockwise.
 - ▶ In edit mode: Press the [OK] softkey.
 - ▷ The cursor moves one position further to the left.
- ▶ To change an entry during text input:
 - ▶ Activate edit mode.
 - ▶ Turn the scrollwheel until the desired letter appears.
 - ▶ Press the [OK] softkey or the operating button.
 - ▷ The selected letter is applied and the cursor moves one place to the left.
 - ▶ Repeat the settings in this way until the cursor has reached the last position.
 - ▶ To apply the entry: press the [OK] softkey.
 - ▷ The changed entry is saved and the control returns to the next higher menu level.

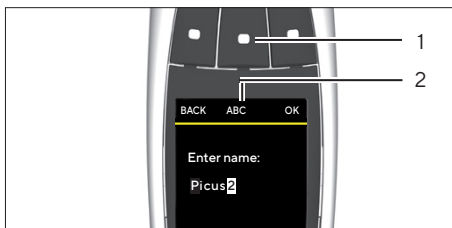

- ▶ To enter lower case letters, numbers or symbols during text input: press the middle softkey (1) until the desired row of characters (2) appears.
- ▶ To delete a position during text input:
 - ▶ Press the middle softkey (1) until the [CLEAR] softkey function appears.
 - ▶ Press the [OK] softkey.
 - ▷ The entry at this position is deleted and the cursor moves one position to the right.

4.5.1 Menus in the Device

► Navigating in menus (see Chapter “4.5 Navigating in Menus”, page 18).

Level 1	Level 2	Description
Device	Main menu	<ul style="list-style-type: none"> – Select the operating mode. – Make settings on the device.
	Advanced functions	Activate advanced functions for a operating mode.
	Memory slots	Save and activate recently used or preferred pipetting settings.

4.6 Menu Structure in the Main Menu

Level 1	Level 2	Description
Menu	Pipetting	<p>Aspirate a selected volume of liquid into the filter tip and then dispense it. This mode is suitable for the following liquids:</p> <ul style="list-style-type: none"> – Aqueous liquids – Liquids with a low quantity of detergents or proteins – Solvents
	Multi-Disp.	<p>Aspirate the total volume and an excess volume of liquid and dispense repeatedly in equal sub-volumes.</p> <p>This mode is suitable for long pipetting rows and for dispensing into microplates.</p>
	Multi. Asp. “Multi-Aspiration”	<p>Set the liquid volume and number of aspiration processes in advance. Then aspirate the selected liquid volumes several times until the cycle is complete. Finally, dispense the entire aspirated liquid volumes in one go. This mode is suitable for merging samples and washing microplates.</p>
	Reverse	<p>Aspirate a selected and an excess volume of liquid. The excess remains in the tip and is disposed of when the tip is ejected. This mode is suitable for the following liquids:</p> <ul style="list-style-type: none"> – Biological liquids – Foaming liquids – Viscous liquids
	Seq. Disp. “Sequential Dispensing”	<p>Repeated dispensing of selected volumes of liquid in a desired sequence. The liquid volumes can be set directly in the operating mode (1 - 9).</p> <p>This mode is suitable for dilution rows or for creating calibration curves.</p>

Level 1	Level 2	Description
Menu	Manual	When aspirating and dispensing liquid volumes, control the piston movement manually with the scrollwheel. This mode is suitable for the following applications: <ul style="list-style-type: none"> – Measuring reagents – Applications in which the pipetting speed must be controlled manually.
	Diluting	Aspirate the volumes of liquid and dispense at the same time. First the dilution solution is aspirated, then an air cushion and finally the sample or reagent, to avoid contamination. This mode is ideal for e.g. diluting samples and reagents.
	Titration	Aspirate the entire liquid volumes and determine the dispensing speed manually. The user display shows the dispensed volume in real-time during dispensing. This mode is suitable for determining the unknown concentration of an identified analyte.
	Settings	Make settings on the device.

4.6.1 Menu Structure in the “Settings” Sub-menu

Level 1	Level 2	Description
Settings	Languages	Set the menu language of the display.
	Themes	Set the UI color by selecting a theme. Default theme selection is model-specific, matching the color of the model’s operating button.
	Bluetooth	Manage the Bluetooth connection.
	Password	Activation of password protection and input of the password. Passwords can be created for an administrator and for a user.
	Sound	Set the sounds on the device.
	Backlight	Set the display lighting.
	Date & time	Enter the date and time.
	Tip ejection	Set the ejection of the filter tip via the operating button.
	User ID	Define the user ID. This is displayed on the display when the device is switched on.
	Adjustment	Activate customer-specific adjustment and set the device to the adjustment points.
	Reminder	Set the reminder function for calibration, maintenance, and quick check.
	Information	View the model variant, the current software and Bluetooth® version, and the battery charge level.
Reset	Reset all modified settings and saved programs to the defaults.	

Level 1	Level 2	Description
Settings	Pip.lock	Lock the device until the next maintenance measure or cleaning process. The lock prevents any use of the device and the message "Pipette locked, maintenance required" is displayed. We recommend this function when there are device errors or the device is contaminated.

4.7 Menu Structure in the "Advanced Functions" Menu

Level 1	Level 2	Description
Advanced functions*	Counter	The counter counts the pipetting cycles.
	Mix. pre. asp.	Activates mixing before aspiration.
	Mix. post disp.	Activates mixing post dispense.
	Excess Adj.	<ul style="list-style-type: none"> – Is intended to define the excess volume (safety volume). – If no excess volume is set: the default value is used.
	Plate Tracker	<ul style="list-style-type: none"> – The tracker makes it easier to dispense into the correct wells of a microplate by specifying the next position on a microplate during dispensing. – Works with 96- and 384 well plates.
	Auto	<ul style="list-style-type: none"> – Auto dispensing is intended for automatic dispensing of partial volumes without having to press the operating button. – The dispensing interval must be defined.
	Fast Vol.	<ul style="list-style-type: none"> – Works with the "Titration" operating mode. – With fast dispensing, a selected quantity of the total volume is dispensed automatically. The remaining volume is then dispensed manually.
	Blowout	<ul style="list-style-type: none"> – Activates repeated blow-out. – This is used for liquid residues in the filter tip or when dispensing liquids that can leave residues in the filter tip. – Can be combined with other advanced functions.

* The "Plate Tracker" and "Counter" advanced functions **cannot** be activated at the same time. The [Blow-out] advanced function can be activated at the same time as all other advanced functions.

4.8 Menu Structure in the "Memory Places" Menu

Level 1	Level 2	Description
Memory slots	M1-M20	Is intended to save and activate pipetting settings. Can be accessed via hotkey.

4.9 List of Parameters

4.9.1 Parameters in the “Advanced Functions” Menu

Parameter	Settings	Settings	Explanation
Counter	ON	0-999	Activates “Counter”. Counter wraps back to 0 if 999 is exceeded.
	OFF*		Deactivates the “Counter” advanced function.
Mix. pre.asp.	ON	Manual Cyclic (1 – 99)	Activates the pre-aspiration mixing function. When activated, it is possible to choose between manual and cyclic mixing.
	OFF*		Deactivates the pre-aspiration mixing function.
Mix. post disp.	ON	Manual Cyclic (1 – 99)	Activates the post-dispensing mixing function. When activated, it is possible to choose between manual and cyclic mixing.
	OFF*		Deactivates the post-dispensing mixing function
Excess Adj.	1-25		Enter the safety volume.
Tracker	ON	96, rows 96, columns 384, rows 384, columns	<ul style="list-style-type: none"> – Activates the “Tracker” advanced function. – Set the number of wells. – Set the direction (pipetting vessel in rows pipetting in columns). – Set the first dispensing position (A1-H12).
	OFF*		Deactivates the “Tracker”.
Auto	ON	0.0 s-9.9 s	Activates “Auto”. Set the interval until the next dispensing step.
	OFF*		Deactivates “Auto”.
Fast Vol.**	ON	50-950 µl	Activates “Fast vol.” Set the volumes.
	OFF*		Deactivates “Fast vol.”
Blowout	ON		Activates “Repeated blow-out”.
	OFF*		Deactivates “Repeated blow-out”.

* Default

** The set values correspond to the volume range of the device, e.g. 50 µl-1000 µl.

4.9.2 Parameters in the “Settings”/“Languages” Menu

Parameter	Settings	Explanation
Languages	Reset	Resets the menu language to the default.
	English*	Sets the menu language of the display to the selected language.
	Deutsch	
	Zhōngwén	
	Français	
Русский		
* Default		

4.9.3 Parameters in the “Settings”/“Theme” Menu

Parameter	Settings	Explanation
Theme	Default*	Resets the display colour to the defaults.
	Gray, white, green, yellow, orange, red, violet, blue	Sets the colour of the display.
* Default		

4.9.4 Parameters in the “Settings”/“Bluetooth” Menu

Parameter	Settings	Explanation
Bluetooth	ON*	Activates Bluetooth on the device.
	OFF	Deactivates Bluetooth on the device.
Pairing	ON	Activates automatic connection with a known device over Bluetooth.
	OFF*	Deactivates automatic connection with a known device over Bluetooth.
Bluetooth Passkey		The Bluetooth password required to connect is displayed.
* Default		

4.9.5 Parameters in the “Settings”/“Password” Menu

Parameter	Settings	Explanation
Password	ON	Activates password protection.
	OFF*	Deactivates password protection.
Admin	Enter password	Creates the admin password.
User	Enter password	Creates the user password.
* Default		

4.9.6 Parameters in the “Settings”/“Sound” Menu

Parameter	Settings	Explanation
Scrollwheel	ON*	Switches the sound on when the scrollwheel is turned.
	OFF	Switches the sound off when the scrollwheel is turned.
Buttons	ON*	Switches the sound on when a softkey is pressed.
	OFF	Switches the sound off when a softkey is pressed.
Messages	ON*	Switches the sound on when a message is displayed about a low battery level.
	OFF	Switches the sound off when a message is displayed about a low battery level.

* Default

4.9.7 Parameters in the “Settings”/“Backlight” Menu

Parameter	Settings	Explanation
Backlight	Very Low Low Medium High	Adapts the display lighting based on the parameters selected.

* Default

4.9.8 Parameters in the “Settings”/“Date & time” Menu

Parameter	Settings	Explanation
Date	DD.MM.YYYY.	Sets the current date.
Time	HH:MM	Sets the current time.

4.9.9 Parameters in the “Settings”/“Tip Ejection” Menu

Parameter	Settings	Explanation
Double Click	ON	Activates ejection of the filter tip by double-clicking on the operating button.
	OFF*	Deactivates ejection of the filter tip by double-clicking on the operating button.
Allow liquid	ON	Activates the ejection of the tip with the safety volume inside.
	OFF*	Deactivates the ejection of the tip with the safety volume inside.

* Default

4.9.10 Parameters in the “Settings”/“Adjustment” Menu

Parameter	Parameter	Settings	Explanation
Adjustment	Factory		Resets the device adjustment to the default.
	Empty Slot 1 Empty Slot 2	1 point	Set the 1-point adjustment. Set the adjustment point and the adjustment volume.
	Empty Slot 3 Empty Slot 4 Empty Slot 5	2 points	Set the 2-point adjustment. Presets the adjustment at 10% and 100% of the nominal volume.
		3 points	Set the 3-point adjustment. Presets the adjustment at 10%, 50% and 100% of the nominal volume.

4.9.11 Parameters in the “Settings”/“User ID” Menu

Parameter	Settings	Explanation
User ID	Enter name:	Creates the user ID. User ID is displayed during device startup.

4.9.12 Parameters in the “Settings”/“Reminder” Menu

Parameter	Parameter	Settings	Explanation
Calibration Maintenance Quick Check	Last Execution	DD.MM.YY	Displays the date of the last maintenance, calibration or Quick Check (editable).
	Enable	ON	Activates the reminder function for calibration, maintenance, or quick check.
		OFF	Deactivates the reminder function for calibration, maintenance, or quick check..
	Type	Interval	Allows you to enter the period of time until the next calibration, maintenance, or quick check as an interval.
		Date	Allows you to enter a fixed date for the next calibration, maintenance, or quick check.
	Expiration date	DD.MM.YY	Specifies the exact date of the calibration, maintenance, or quick check. Only displayed if [Date] was selected under “Type”.
	Interval value	1 - 4 weeks 1 - 12 months	Specifies the period of time until the calibration, maintenance, or quick check. Only displayed if [Interval] was selected under “Type”.
	Snooze	ON	Activates the snooze function for the reminder alarm.
		OFF	Deactivates the snooze function for the reminder alarm.
	Lock	Manual	Sets the manual locking function. The device can be manually locked once the date for the next calibration, maintenance, or quick check has arrived.
		Auto	Sets the automatic locking function. The device is automatically locked once the date for the next calibration, maintenance, or quick check has arrived.

4.9.13 “Settings”/“Reset” Menu

Parameter	Settings	Explanation
Reset	NO	Does not reset the device to the defaults.
	YES	Resets the device to the defaults.

5 Installation

5.1 Scope of Delivery

Item	Quantity
Picus® 2	1
USB connection cable	1
For models with a volume of > 10 µl:	1
– Safe-Cone Filter	
– Tweezers	
For 1-channel models: autoclavable grease	1
ID Stickers	3
Quick Start Guide	1
Quality Control Certificates	1

5.2 Unpacking

Procedure

- ▶ Unpack the device.
- ▶ Sartorius recommends keeping the original packaging so that the device can be returned properly, e.g. for repairs or maintenance.

5.3 Acclimatization

When a cold device is brought into a warmer area: The temperature difference can lead to condensation from humidity in the device (moisture formation). Moisture in the device can lead to malfunctions.

Procedure

- ▶ Allow the device to acclimatize to the installation site.

5.4 Inserting a Safe-Cone Filter

Sartorius recommends the use of Safe-Cone filters to avoid contamination. Safe-Cone filters must not be used together with the Safetyspace filter tips.

Procedure

- ▶ Insert a Safe-Cone Filter in the tip cone using the tweezers supplied.

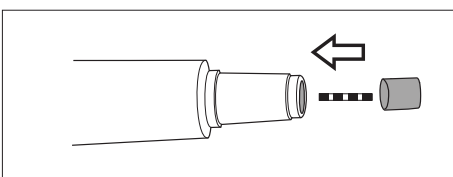

6 Commissioning

6.1 Clean the Device

It is possible that the device becomes dirty during transport. We recommend cleaning and decontaminating the device before first use (see Chapter "9 Cleaning and Maintenance", page 40).

6.2 Charging the Device

The device is delivered with the battery partially charged. We recommend fully charging the device for 1 hour before first use.

6.2.1 Charging with the Charging Carousel or Charging Stand

Procedure

- ▶ Make sure the charging stand | charging carousel is connected to the power supply.
- ▶ Insert the device into the charging grooves.
- ▶ Check that the charging contacts of the device are fully inserted in the charging grooves.

6.2.2 Charging with the USB Charger

Procedure

- ▶ Slide open the cover of the USB port (1).
- ▶ Connect the connection cable to the micro USB port of the device.
- ▶ Connect the other end of the connection cable to a mains plug via the USB- port
- ▶ Connect the mains plug to the socket (supply voltage) at the installation site.



6.3 Switching the Device On or Off

Procedure

- ▶ To switch the device on:
 - ▶ Press the On | Off button.
 - ▶ If password protection is activated: log in with the password.
 - ▶ When the device is switched on for the first time: enter the date and the time in the query.
- ▷ The device actuates the piston.
- ▷ The device is ready for use.

- ▶ To switch the device off:
 - ▶ If password protection is activated: log out of the profile being used. To do this, briefly press the On | Off button.
 - ▶ Press and hold the On | Off button for a few seconds.

6.3.1 Returning to Active Mode

During use and charging, the device is in active mode. All processor functions are activated and the backlighting on the display is switched on. When the device is not used (for a long time) it behaves as follows:

- If the device is not used for more than 30 seconds: the device is in energy saving mode and the backlight is dimmed.
Pressing any key or turning the scrollwheel let return to the active mode.
- If the device is not used for more than 10 minutes: the backlight switches off.
Pressing the On | Off button lets return to active mode.
- If the device is not used for more than 4 hours: the device switches itself off.

6.4 Rinsing Tips

Sartorius recommends to rinse the tips before operating.

Requirements

Tips are attached to the cone.

Procedure

- ▶ Open the main menu.
- ▶ Set the operating modus "Pipetting".
- ▶ Aspirate water. To do so, press the operating button.
- ▶ Dispense water. To do so, press the operating button again.
- ▶ Repeat aspirating and dispensng 3 - 5 times.
- ▷ The Tips are rinsed.

7 System Settings

7.1 Setting Defaults

Defaults, which are coordinated with the ambient conditions and the requirements during operation, can be set for the device and the applications.

To configure the device, the following settings are recommended:

- Set the menu language
- Set the adjustment

Procedure

- ▶ Open the main menu.
- ▶ Open the “Settings” sub-menu.
- ▶ To make settings: Open the desired menu item.
- ▶ Select the desired parameters and confirm (for parameters, see Chapter “4.9 List of Parameters”, page 23).
- ▶ Exit the menu.

7.2 Connecting the Device to the Sartorius Pipetting Mobile App

Requirements

Bluetooth is activated on the device (see Chapter “4.9.4 Parameters in the “Settings”/“Bluetooth” Menu”, page 24).

Procedure

- ▶ Download the Sartorius Pipetting Mobile App. To do this, select one of the following options:
 - ▶ Scan the QR code on the Quick Guide.
 - ▶ Open the App Store on the device and find the Sartorius Pipetting mobile app.
- ▶ When the app has been successfully downloaded: open the Sartorius mobile app.
- ▶ Enter the Sartorius ID and the password.
- ▶ The main menu is displayed.
- ▶ Press the [My Pipette sets] button.



- ▶ Add a new set. To do this, proceed as follows:
 - ▶ Press the [Add] button.
 - ▶ The “New pipette set” display opens.
 - ▶ Fill in the parameters and set the tick.
 - ▶ Confirm the entries.

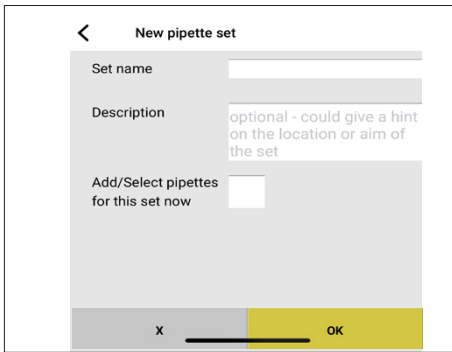

- ▶ The “Select pipette type” display opens.
- ▶ To add the device to the set:
 - ▶ Select the “Sartorius Connected” parameter and confirm.
 - ▶ The app searches for available devices and lists them.
 - ▶ Select and confirm your own device.
- ▶ The device is added to the set.

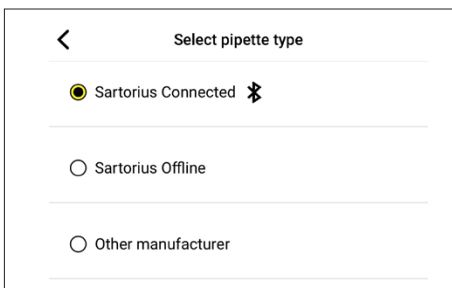

7.3 Managing User Data

7.3.1 Creating a User ID

Procedure

- ▶ Open the main menu.
- ▶ Open the “Settings” sub-menu.
- ▶ Open the “User ID” menu option.
- ▶ Create a name and confirm.

7.3.2 Activating Password Protection

The device has two levels of password protection. The top level is for the administrator with all access rights. The bottom level is for the user with limited access rights. If password protection is active: only the administrator has access to the following functions:

- Managing passwords
- Setting the date and time
- Setting reminders
- Creating and saving protocols
- Saving programs (hotkey)
- Managing adjustment settings

When the password is activated, users have limited access to the device functions and can call up the following functions, for example: operating modes, backlight or user ID.

Procedure

- ▶ Open the main menu.
- ▶ Open the “Settings” sub-menu.
- ▶ Open the “Password” menu option.
- ▶ Select the “Login” parameter and set to “ON”.
- ▶ Select the parameters “User” and “Administrator” one after the other and assign a password.
- ▶ Confirm the entry with the [OK] soft key.
- ▶ Save the changes made with the [SAVE] soft key.
- ▷ Password protection is enabled.

7.3.3 Logging Into or Out of the Device

When password protection is activated, operators must log into and out of the device. Login is performed directly after switching on. Logging out is **not** possible during an active operating mode.

Procedure

- ▶ To log in the operator: switch on the device.
- ▷ A password request is displayed.
- ▶ Enter the user or administrator password and confirm.
- ▶ To log out the operator: briefly press the On | Off button.
- ▷ The user profile is logged out.

7.3.4 Deactivating Password Protection

Requirements

The administrator profile is logged in.

Procedure

- ▶ Open the main menu.
- ▶ Open the “Settings” sub-menu.
- ▶ Open the “Password” menu option.
- ▷ A password request appears.
- ▶ Enter the administrator password.
- ▶ Select the parameter “Password” and set to “OFF”.
- ▶ Save the changes made with the [SAVE] soft key.
- ▷ Password protection is deactivated.

7.4 Adjusting the Device

The piston stroke is designed for normal conditions as standard:

- Aqueous liquids
- Normal pressure
- Device, tip and liquid at room temperature

If the conditions change: the accuracy of the dispensed volume may change. The adjustment function can ensure that the device remains accurate. Adjustment of the dispensed volume is required in the following cases:

- The pipetting liquid's properties are significantly different from those of water, e.g. viscous or volatile liquids.
- The temperature of the device, pipetting tip and liquid deviates significantly.
- The ambient air pressure differs from normal pressure.

The adjustment function enables the device to be set to one or more adjustment points. The more adjustment points are selected, the greater the accuracy over the entire volume range of the device. Sartorius recommends the following settings:

- 1-point adjustment: pipetting a constant volume within a range
- 2-point or 3-point adjustment: pipetting volumes within the entire range

When adjusting the accuracy, the actual volumes obtained should be measured in pipetting mode. After adjustment has been carried out, it will be applied to all modes and a symbol for adjustment will be displayed.

Procedure

- ▶ If password protection is activated: log in with the admin password.
- ▶ Open the main menu.
- ▶ Open the "Settings" sub-menu.
- ▶ Open the "Adjustment" menu option.
- ▶ Select the parameter under which the adjustment settings should be saved, e.g. Empty Slot 1.
- ▶ Activate edit mode.
- ▶ Set a name.
- ▶ Select the number of adjustment points.
- ▶ Confirm the selection.

Set the target volume for adjustment points (1-point adjustment)

Procedure

- ▶ For 1-point adjustment: set the target volume and press [EDIT].



Set the target volume for adjustment points (2-point or 3-point adjustment)

Procedure

- ▶ Confirm the automatically set target volume.

Setting the measured volume

Procedure

- ▶ Enter the volume actually measured and confirm.

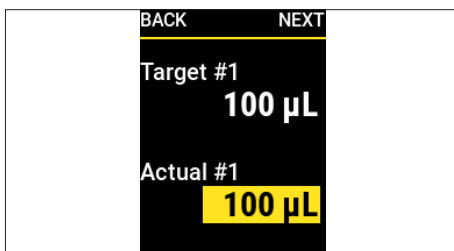

- ▷ Configuration summary is displayed.
- ▶ Save the set adjustment data.

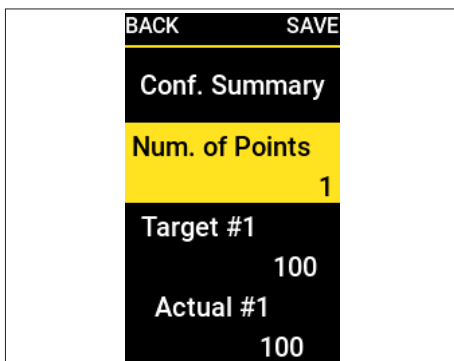

7.4.1 Activating the Adjustment Setting

Procedure

- ▶ If password protection is activated: log in with the admin password.
- ▶ Open the main menu.
- ▶ Open the “Settings” sub-menu.
- ▶ Open the “Adjustment” menu option.
- ▶ Pick the desired parameter.
- ▶ The top of the menu (1) indicates which parameter is activated.

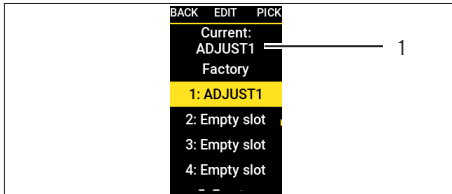

- ▶ Return to operating mode.
- ▶ The adjustment is applied to all operating modes.
- ▶ The selected adjustment setting is displayed (2).

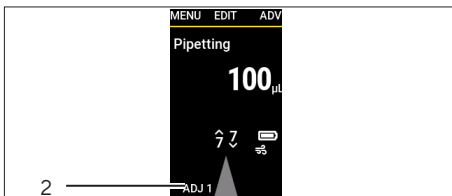

7.5 Setting Up Reminders

The device enables the configuration of reminders for the following activities:

- Maintenance
- Calibration
- Quick checks

Reminders can be set as a date or interval (weeks | months). To set both a date and an interval: the criterion that is reached first triggers the reminder function and reminds the user about the due measures via a message and a signal sound. It is possible to snooze the reminder for a set number of days. For deadline-based reminders, the user is reminded 14 days before the deadline.

Procedure

- ▶ If password protection is activated: log in with the admin password.
- ▶ Open the main menu.
- ▶ Open the “Settings” sub-menu.
- ▶ Open the “Reminder” menu option.
- ▶ Select and confirm the reminder type, e.g. calibration.

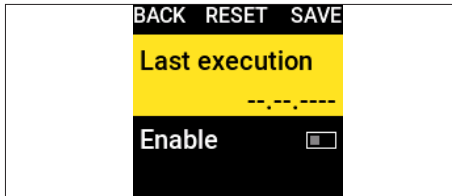

- ▶ Set the reminder functions one after the other:
 - ▶ Set the date of the last calibration.
 - ▶ If necessary: define the date of the next calibration and apply.
 - ▶ If necessary: define the interval until the next calibration and apply.
 - ▶ If necessary: activate the snooze function and set the number of days.
- ▶ When all desired reminder functions have been set: press the [SAVE] softkey.
- ▷ All settings are saved and the reminder function is activated.
- ▷ The display returns to the “Settings” sub-menu.

7.5.1 Deactivating Reminders

- ▶ If password protection is activated: log in with the admin password.
- ▶ Open the main menu.
- ▶ Open the “Settings” sub-menu.
- ▶ Open the “Reminder” menu option.
- ▶ Select and confirm the reminder type.
- ▶ To deactivate a reminder function: set to [OFF] and skip to the next parameter.
- ▶ When the desired reminder functions have been deactivated: press the [SAVE] softkey.
- ▷ All settings are saved and the reminder function is deactivated.
- ▷ The display returns to the “Settings” sub-menu.

8 Operation

8.1 Using Operating Modes (Examples)

8.1.1 Multi Dispensing

Requirements

Tips are attached to the cone.

Procedure

- ▶ Open the main menu.
- ▶ Select the "Multi Disp." pipetting mode and confirm.
- ▷ The display shows the last pipetting settings for the "Multi Disp." pipetting mode.
- ▶ To change pipetting settings: activate edit mode.
- ▶ Edit the desired settings and confirm.
- ▶ To activate advanced functions or adapt the safety volume:
 - ▶ Press the [ADV] softkey.
 - ▶ Select and activate the desired advanced functions (see Chapter "4.7 Menu Structure in the "Advanced Functions" Menu", page 22).
- ▶ To aspirate liquid: press the operating button.
- ▷ The selected volume and safety volume are aspirated.
- ▶ To eject the primary excess: press the operating button.
- ▶ Press the operating button until all sub-volumes have been dispensed.
- ▷ The message: "Double-click to empty?" is displayed.
- ▶ To continue with repeated dispensing without emptying the filter tip: press the [NO] softkey.
- ▶ To empty the filter tip: press the operating button twice.
- ▶ To eject the filter tip: press the electronic tip ejection.

8.1.2 Manual Pipetting

Requirements

Tips are attached to the cone.

Procedure

- ▶ Open the main menu.
- ▶ Select the "Manual" pipetting mode.
- ▶ To change pipetting settings: activate edit mode.
- ▶ Edit the desired settings and confirm.
- ▶ To start the pipetting process: press the operating button.

- ▶ Aspirate the liquid. To do this, use one of the following options:
 - ▶ Press and hold the operating button. The aspiration speed is constant.
 - ▶ Turn the scrollwheel anti-clockwise. The further the scrollwheel is turned, the higher the aspiration speed.
- ▶ To interrupt the process: release the operating button or the scrollwheel.
- ▶ To switch to dispensing: turn the scrollwheel briefly clockwise.
- ▷ The display arrow points down.

Dispensing liquids

Procedure

- ▶ Dispense the liquid. To do this, use one of the following options:
 - ▶ Press and hold the operating button. The dispensing speed is constant.
 - ▶ Turn the scrollwheel clockwise. The further the scrollwheel is turned, the higher the dispensing speed.
- ▶ When the entire volume has been dispensed: press the operating button.
- ▷ The message "Double-click to empty?" is displayed.
- ▶ To aspirate liquid again: press the [NO] softkey.
- ▶ To empty the tip: press the operating button.
- ▶ To eject the tip: press the electronic tip ejection.

8.2 Locking and Unlocking the Device

The device can be locked to prevent further use. This function can be used when an error has occurred in the device, for example, or the device has become contaminated.

8.2.1 Activating the Device Lock

Procedure

- ▶ Open the main menu.
- ▶ Open the "Settings" sub-menu.
- ▶ Select the "Pip. Lock" menu item and confirm.
- ▷ The display shows "Lock pipette"?
- ▶ Confirm the lock with the [YES] softkey.
- ▷ The device is locked.

8.2.2 Opening the Device Lock

Procedure

- ▶ Press the [UNLOCK] softkey.
- ▶ If password protection is activated: enter the admin password.
- ▷ The device is unlocked and the device is ready for use.

9 Cleaning and Maintenance

Sartorius recommends the following cleaning measures:

- Clean the surface of the device daily.
- For 1-channel models: decontaminate, clean and grease the lower section regularly.
- For multi-channel models: send the device to your local Sartorius Service Centre for maintenance.
- If Safe-Cone-Filter are used: Replace them regularly.

No liquids must enter the inside of the device.

9.1 Cleaning the Outer Surface of the Device

- Materials:
- Gloves
 - Cleaning agents
 - Soft, lint-free cloth

Requirements

- The process is finished.
- The filter tip has been ejected.

Procedure

- ▶ Switch off the device.
- ▶ Only use suitable cleaning agents and cleaning procedures and note the product information for the cleaning agent used (see Chapter “14.9 Cleaning Agents and Cleaning Methods”, page 57).
- ▶ Dampen the cloth with the cleaning agent.
- ▶ Clean the device housing with the damp cleaning cloth.
- ▶ Wipe the device housing dry.
- ▶ Perform performance check (see Chapter “9.4 Performance Check”, page 45).

9.2 Cleaning the Lower Assembly of the Device

CAUTION

Risk of injury due to unprotected, moving parts!

Exposed moving parts can cause injuries.

- ▶ Switch off the device before cleaning and maintenance work.
-

The cleaning steps described below only apply to 1-channel models.

Materials:

- Gloves
- Cleaning agents
- Grease

Tool:

- Tweezers
- Soft, lint-free cloth
- Cotton swabs
- Brush

9.2.1 Removing the Safe-Cone Filter

Procedure

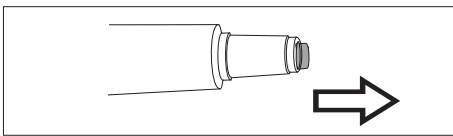

- ▶ Remove the Safe-Cone Filter from the tip cone using the tweezers supplied and dispose of it.

9.2.2 Dismantling the Lower Assembly (1-channel Models)

For models with a volume range < 5,000 μ l

Procedure

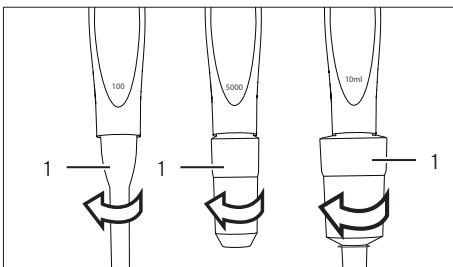

- ▶ Unscrew the tip ejector (1) in a clockwise direction.

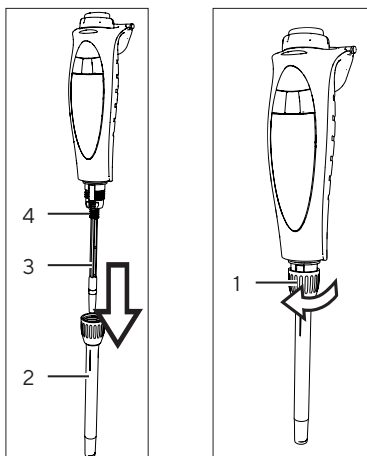

- ▶ Turn the tip cone holder (1) clockwise and slowly pull off together with the tip cone (2).
- ▶ Slowly pull the spring (4) off the piston (3).

For models with a volume range = 5,000 μ l

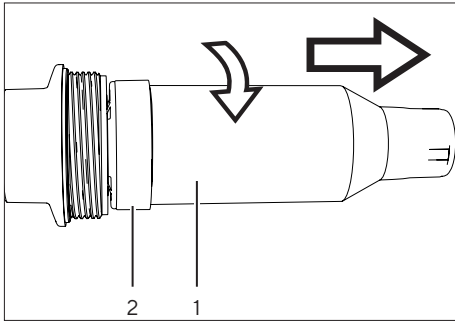

- ▶ Hold the tip cone holder (2) with one hand and use the other hand to turn the tip cone cylinder (1) clockwise and pull it off.

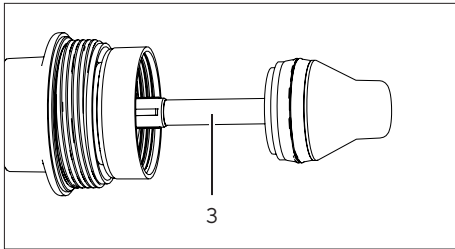

- ▶ The piston (3) is exposed.

For models with a volume range = 10,000 μ l

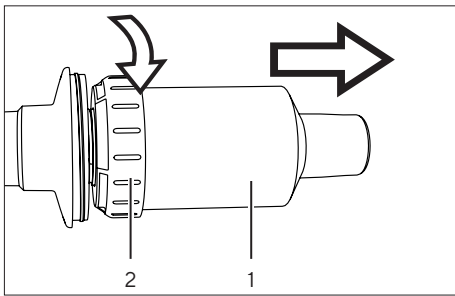

- ▶ Hold the tip cone cylinder (1) with one hand and use the other hand to turn the locking ring (2) clockwise and pull the tip cone off.

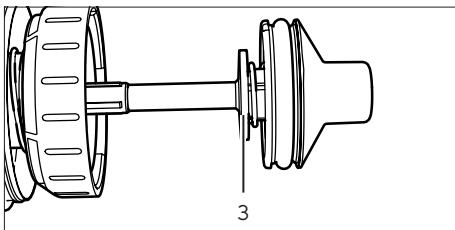

- ▶ The piston (3) is exposed.

9.2.3 Cleaning Individual Components (1-channel Models)

- ▶ Dampen the cloth with suitable cleaning agent (see Chapter "14.9.1 Cleaning Agents", page 57).
- ▶ Wipe the outside of the following components with the damp cloth.
 - Piston
 - Spring (if present)
 - Tip cone
 - Tip cone holder
 - Tip ejector
- ▶ Moisten a cotton swab with suitable cleaning agent and carefully use it to clean the inside of the tip cone and tip ejector.
- ▶ If necessary: rinse the components with distilled water.
- ▶ Leave all components to dry.

9.2.4 Assembling the Lower Section (1-channel Models)

Models up to 1,000 μ l

Procedure

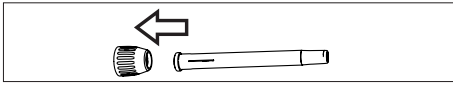

- ▶ Slide the spring over the piston.
- ▶ Place the tip cone in the tip cone holder.

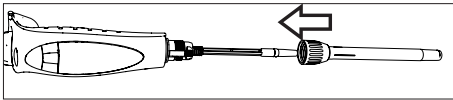

- ▶ Slide the tip cone holder together with the tip cone over the piston.

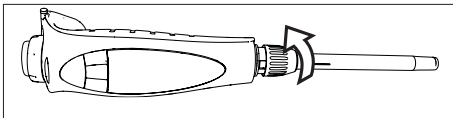

- ▶ To secure the tip cone holder and tip cone: turn the tip cone holder anti-clockwise to tighten.

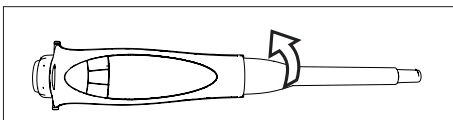

- ▶ Slide the tip ejector over the tip cone and secure by turning it anti-clockwise.

- ▶ Insert a new Safe-Cone Filter (see Chapter 5.4, page 28).
- ▶ To ensure that the grease is evenly distributed:
 - ▶ Switch on the device.
 - ▶ Press the operating button several times.
- ▶ Check the operation of the device.

Models with 5,000 μ l

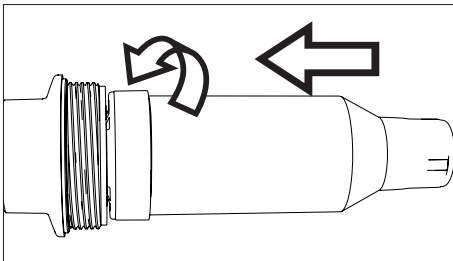

- ▶ Slide the tip cone over the piston and secure by turning it anti-clockwise.
- ▶ Check that the tip cone is **not** too tight.

Models with 10,000 μ l

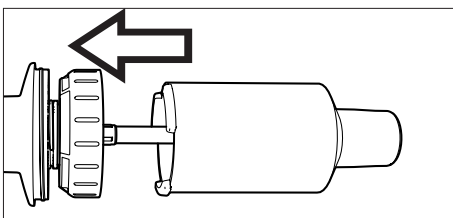

- ▶ Slide the tip cone and tip cone holder slowly over the piston and secure by turning anti-clockwise.

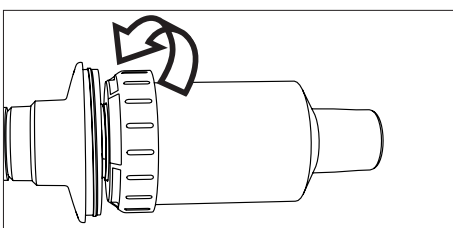

- ▶ Check that the tip cone is not too tight.

9.3 Sterilising the Lower Assembly

The lower assembly of the device can be sterilised using the following measures:

- Autoclaving (excluding 1,200 µl models)
- UV radiation
- Approved cleaning agent

9.3.1 Autoclaving

The lower assembly of the device is autoclavable, except on multi-channel models with a nominal volume of 1,200 µl. There is a symbol on autoclavable assemblies.

Materials: Autoclaving bag

Requirements

- There is an autoclaving symbol on the lower assembly.
- The Safe-Cone Filters have been removed.

Procedure

- ▶ Dismantle the lower assembly:
 - ▶ For 1-channel models, see Chapter 9.2.2, page 41.
 - ▶ For multi-channel models: unscrew the dosing head (1) clockwise and remove the cone housing.

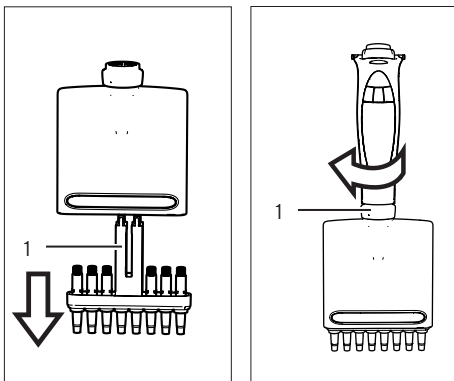

- ▶ Place the autoclavable components in an autoclaving bag:
 - For 1-channel models: tip ejector, tip cone, tip cone holder
 - For multi-channel models: tip cone housing
- ▶ Autoclave the components (settings for autoclaving, see Chapter 14.9.2, page 57).
- ▶ Leave the components to cool and dry
- ▶ Assemble the components on the control head again:
 - ▶ For 1-channel models, see Chapter 9.2.4, page 43.
 - ▶ For multi-channel models: insert the cone housing into the dosing head and screw the dosing head onto the control head by turning it anti-clockwise.

9.4 Performance Check

It is recommended that the device performance be reviewed regularly. This should be done after every in-house maintenance procedure or at least every three months.

We also recommend that the operator develop a regular test routine that takes the following criteria into account:

- Accuracy requirements of the relevant application
- Frequency of use
- Number of operators for the device
- Nature of the liquid dispensed
- Acceptable maximum permissible errors (ISO 8655-2)

The performance review should be carried out in the corresponding ambient conditions (see Chapter 14.2, page 53). The device, filter tips and test liquid should be stored in the room for at least two hours so that they can adjust to the room temperature.

Sartorius specifications are achieved in strictly controlled conditions (ISO 8655-6). We recommend defining an acceptable error range that reaches the application area and the accuracy conditions under which the device is operated.

9.4.1 Weighing

Materials: – Distilled, de-ionised water (ISO 3696, quality 3)
 – Test water vessel
 – Pipette tips

Tool: Analytical balance scales in compliance with ISO 8655-6

Requirement

The “Pipetting” pipetting mode is set on the device.

Procedure

- ▶ Set the desired test volume.
- ▶ Place the tip on the cone.
- ▶ To achieve a humidity balance in the unused air volume: aspirate and dispense the test water five times with the filter tip.
- ▶ Replace the tip.
- ▶ To prewet the tip again:
 - ▶ Hold the device vertically and submerge the filter tip just 2–3 mm under water.
 - ▶ Press the operating button.
- ▶ Pull the device vertically out of the water and wipe the tip on the side wall of the test water vessel.
- ▶ To pipette the water into the vessel: Wipe the tip above the liquid level at an angle of approx. 30° to 45° on the side wall of the vessel while pulling the device 8–10 mm along the inner wall.
- ▶ Read the weight in mg/s (mi).
- ▶ Repeat the test cycle nine more times

- ▶ When a total of ten measurements have been recorded: Convert the recorded masses (m_i) into volume (V_i) by multiplying them with a correction factor Z . The following applies: $V_i = m_i \cdot Z$ (for Z scores, see Chapter 14.11, page 58).
- ▶ Calculate the average volume: (V): $V = (V_i)/10$.
- ▶ To evaluate conformity: calculate the systematic error “eS” of the measurement. Use the following formula:
 - in μl : $eS = V - VS$
 - or in %: $eS = 100 (V - VS)/VS$
 - VS = selected test volume
- ▶ Calculate the random error of the measurement as the standard deviation. Do this using the formula. n = number of measurements (10).
- ▶ Compare the systematic error and the random error with the values of the performance specification from your own laboratory.

$$s = \sqrt{\frac{\sum(V_i - \bar{V})^2}{n - 1}}$$

9.5 Maintenance Schedule

Interval	Component	Activity
6 to 24 months, depending on the operating conditions	Device	Contact Sartorius Service.
Regularly depending on the operating conditions	Tip cone	Grease the components (see 9.6, 46).

9.6 Greasing Components (1-channel models)

Requirement

The lower assembly is dismantled.

Procedure

- ▶ Wet the brush with the grease supplied.

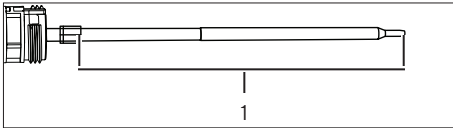

For models with 3 µl | 10 µl | 120 µl

- ▶ Apply a thin layer of grease to the piston (1).

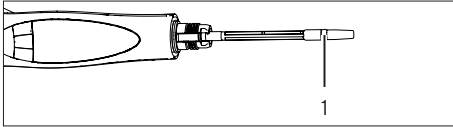

For models with 300 µl | 1,000 µl

- ▶ Apply a thin layer of grease around the seal (1).

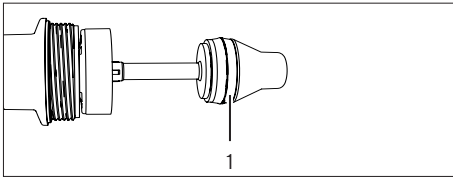

For models with 5,000 µl | 10,000 µl

- ▶ Apply a thin layer of grease inside the tip cone and around the seal (1).

9.7 Performing a Software Update

A software update can be performed via the mobile app. In the mobile app, you can see which devices have not yet been updated to the current software version.

The current software version of the device is specified under the parameter “Settings”/“Information”.

A software update can extend or change the functionality of the device. Sartorius recommends performing the software update regularly.

Requirement

- The desired device is switched on.
- If password protection is activated: be logged in with the admin password.
- Bluetooth is activated on the device (see Chapter “4.9.4 Parameters in the “Settings”/“Bluetooth” Menu”, page 24).

Procedure

- ▶ Open the Sartorius mobile app.
 - ▶ If necessary: log in with the Sartorius ID.
- ▶ Press the [PIPETTES ADMINISTRATION] button.
- ▷ The App searches for devices nearby.
- ▷ A list of found devices opens.
- ▶ Select the desired device and press the [UPDATE] button.
- ▷ The device display displays the update progress.
- ▷ When the update is completed, the device is no longer displayed in this list.

10 Trouble

10.1 Troubleshooting

Fault	Cause	Remedy	Chapter, page
Droplets remain in the tip.	The tip is not compatible.	Use original Sartorius tips. Check that the tip is securely seated and, if necessary, tighten.	
	The device is contaminated.	Clean the device.	9, 40
	The device is defective.	Replace the defective parts. Send the device in for servicing.	
Inaccurate function	The device is contaminated.	Clean the device.	9, 40
	The device is defective.	Replace the defective parts. Send the device in for servicing.	
The device is switched off.	Pipette in Off mode	Switch on the device.	6.3.1, 30
	The battery is empty.	Connect the device to the charger.	6.2, 29
The piston jams	Internal components are loose	Open the lower assembly and ensure the parts are securely fitted.	9.2.2, 41
	Pipette contaminated	Clean the pipette.	9, 40
	Pipette defective	Replace defective parts. Send the device in for servicing.	
The aspirated volume is too small	The Safe-Cone Filter is contaminated	Replace the Safe-Cone Filter.	9.2.1, 41 5.4, 28
	The device is contaminated.	Clean the device.	9, 40
	The device is defective	Replace the defective parts. Send the device in for servicing.	
The device does not respond.		Reset the device to the defaults.	10.2, 49
		Send the device in for servicing.	

10.2 Resetting to Defaults

When resetting to defaults, the stored settings and the other information contained in the memory are not changed.

Requirements

- The device is not connected to the charger.
- The device is not connected to the USB cable.

Procedure

- ▶ Press and hold the On | Off button and the right softkey button simultaneously for a few seconds.
- ▷ The device switches itself off.
- ▶ To switch on: press the On | Off button.
- ▷ The device is reset to the defaults.

11 Decommissioning

11.1 Decommissioning the Device

Requirements

The filter tip(s) has | have been ejected.

Procedure

- ▶ If password protection is activated: log out of the user profile.
- ▶ Switch off the device.
- ▶ Remove the Safe-Cone Filter.
- ▶ Clean the device.

12 Storage and Shipping

12.1 Storage

We recommended storing the device on the charging stand when not in use.

Procedure

- ▶ Switch off the device.
- ▶ Check that the ambient conditions are met (see Chapter “14.2 Ambient Conditions”, page 53).
- ▶ If present: place the device in the charging station.
- ▶ If the device is not used for several months: disconnect the charging stand from the power supply.

12.2 Returning the Device and Parts

Defective devices or parts can be returned to Sartorius. Returned devices must be clean, decontaminated, and packaged properly.

Transport damage and measures for retrospective cleaning and disinfection of the device or parts by Sartorius shall be charged to the sender.

Devices contaminated with hazardous substances, e.g. harmful biological or chemical substances, will **not** be accepted for repair and disposal.

Procedure

- ▶ Decommission the device.
- ▶ If necessary: decontaminate the device.
- ▶ Contact Sartorius Service for information on how to return devices or parts (see www.sartorius.com).
- ▶ Pack the device and its parts properly for return.

13 Disposal

13.1 Disposing of the Device and Parts

The device and its accessories must be disposed of properly by disposal facilities.

A lithium battery is installed inside the device. Batteries must be disposed of properly by disposal facilities.

Procedure

- ▶ Dispose of the device in accordance with the country-specific legal provisions. Inform the disposal facility that there is a lithium battery inside the device.
- ▶ Dispose of the packaging in accordance with the country-specific legal provisions.
- ▶ Dispose of the consumables in accordance with the country-specific legal provisions.

14 Technical Data

14.1 Dimensions and Weights

14.1.1 1-channel models

		LH-747021	LH-747041	LH-747061	LH-747081	LH-747101	LH-747111
	Unit	Value	Value	Value	Value	Value	Value
Length	mm	208	214	211	214	185	185
Weight	g	102	104	103	105	117	127

14.1.2 Multi-channel models with 8

		LH-747321	LH-747341	LH-747361	LH-747391
	Unit	Value	Value	Value	Value
Length	mm	217	218	214	214
Weight	g	167	169	164	176

14.1.3 Multi-channel models with 12

		LH-747421	LH-747441	LH-747461	LH-747491
	Unit	Value	Value	Value	Value
Length	mm	217	218	214	214
Weight	g	195	197	190	215

14.2 Ambient Conditions

	Unit	Value
Laboratory, for indoor use only		
Pollution level according to IEC 61010-1		II
Maximal height above sea level	m	2000
Suitable for protection class		
Protection class of the device, as per DIN EN 60529-1		IP 40
Temperature		
In operation	°C	+15 - +30
During performance review	°C	+15 - +30
In storage during transport	°C	-20 - +40
Relative humidity, in operation		
At temperatures up to 31°C, maximum	%	80
No potentially explosive areas		
Other properties		
Store dry		

14.3 Electrical Data

14.3.1 Power Supply

	Unit	Value
Alternating voltage	V _{AC}	100 - 240 (± 10 %)
Frequency	Hz	50
Current consumption, maximum	A	0.125
Power supply only permitted through mains connection cable provided by Sartorius		
Protection class, as per IEC60950-1, (reinforced insulation between mains and secondary circuit)		II
Surge category according to IEC 60664-1		II
Connection cable		
Connection cable with micro-USB port		
Length	m	1,8

14.3.2 Safety of Electrical Equipment

Safety provisions in accordance with EN 61010-1 / IEC 61010-1 Safety requirements for electrical equipment for measurement, control, and laboratory use – Part 1: General requirements

Safety of electrical equipment, in accordance with EN 61326-1 / IEC 61326-1 Electrical equipment for measurement, control and laboratory use – EMC requirements – Part 1: General requirements.

14.3.3 Safety and Electromagnetic Compatibility

Safety of electrical equipment, in accordance with EN 61326-1 / IEC 61326-1 Electrical equipment for measurement, control and laboratory use – EMC requirements – Part 1: General requirements.

Interference immunity: Suitable for use in industrial areas

Emitted interference: Class B; Suitable for use in residential areas and areas that are directly connected to a low-voltage network that also supplies residential buildings.

14.4 Interfaces

	Unit	Value
Micro USB port		
Communication: USB host (Connection cable)		
Bluetooth® 5.3 LE, BMD-350		
Transmission power, maximum	dBm	4
Range	m	10

14.5 Operating Modes with Advanced Functions

	Tracker	Mixing	Counter	Safety Volume	Auto-Dispensing	Fast Dispensing	Repeated Blow-out
Pipetting	■	■	■				■
Reverse Pipetting	■		■	■			
Manual Pipetting							■
Multi Dispensing	■			■	■		
Diluting		■					■
Sequential Dispensing	■			■	■		
Multi Aspiration							■
Titration						■	

14.6 Acceleration Sensor

	Unit	Value
Type: LIS331DLH		
Quantity		1
Measuring range: 3 axes		

14.7 RFID Tag

	Unit	Value
Type: HTS 2048 RFIC IC		
Quantity		1
Frequency	kHz	125

14.8 Materials

Housing

1.4404, aluminium

Plastic PBT | PA

User display

Plastic PBT | PP

Float glass

Tip ejector

For devices with 10 µl | 120 µl | 300 µl: polyvinylidene fluoride (PVDF)

For devices with 5,000 µl | 10,000 µl: polypropylene (PP)

Tip cone holder

For devices with 10,000 µl: polyetherimide (PEI)

For all other devices: polyamide (PA)

Tip cone

For devices with 10 µl: polyvinylidene fluoride (PVDF)

For devices with 200 µl | 300 µl: polyetherimide (PEI)

For devices with 1,000 µl | 5,000 µl | 10,000 µl: polyphenylene sulphide (PPS)

Piston

For devices with 3 µl | 10 µl | 20 µl: stainless steel (SS)

For devices with 1 channel and 100 µl: polyphenylene sulphide (PPS)

For devices with 8 | 12 channels and 100 µl: polyetherimide (PEI)

For devices with 200 µl | 300 µl | 1,000 µl | 5,000 µl: polyphenylene sulphide (PPS)

Piston seal

For devices with 3 µl | 10 µl | 20 µl | 10,000 µl: fluoroelastomer (FKM)

For devices with 100 µl | 200 µl | 1,000 µl | 5,000 µl: ethylene propylene diene monomer rubber (EPDM)

Spring

Stainless steel (SS)

For devices with 10 µl

14.9 Cleaning Agents and Cleaning Methods

14.9.1 Cleaning Agents

Approved cleaning agent
Mild cleaning agent (e.g. 70% ethanol solution 65% isopropanol solution)
Disinfectant and decontamination solution (e.g. 70% ethanol, 65% isopropanol)

14.9.2 Cleaning Methods

Approved cleaning methods		
Wiping the device surfaces with a slightly damp cleaning cloth		
Wiping the device surfaces dry		
Replacing the Safe-Cone Filters with the tweezers		
Autoclaving		
Autoclaving, type		
Autoclaving temperature, maximum	C	121°
Approved overpressure	bar	1
Duration, maximum	Minutes	20

14.10 Battery

	Unit	Value
Li-polymer battery with protective circuit, rechargeable		
Service life at room temperature, expected	Years	2
Capacity	mAh	350
Charging time	h	1

14.11 Z Scores ($\mu\text{l}/\text{mg}$) for Performance Review

Temperature	Air pressure			
	95	100	101.3	105
Unit	Unit	Unit	Unit	Unit
$^{\circ}\text{C}$	kPa	kPa	kPa	kPa
Value	Value	Value	Value	Value
20.0	1.0028	1.0028	1.0029	1.0029
20.5	1.0029	1.0029	1.0030	1.0030
21.0	1.0030	1.0031	1.0031	1.0031
21.5	1.0031	1.0032	1.0032	1.0032
22.0	1.0032	1.0033	1.0033	1.0033
22.5	1.0033	1.0034	1.0034	1.0034
23.0	1.0034	1.0035	1.0035	1.0036
23.5	1.0036	1.0036	1.0036	1.0037

14.12 Performance Specification

14.12.1 Models LH-747021 | LH-747041 | LH-747061 | LH-747081 | LH-747101 | LH-747111

Channel	Colour of the operating button	Volume range	Increment	Test volume	Mode*	Systematic error ±		Random error ± ±**		
						Unit	Unit	Unit	Unit	
		µl	µl	µl	µl	%	µl	%	µl	
Value	Value	Value	Value	Value	Value	Value		Value		
LH-747021	1	■	0.2-10	0.01	10	P	1.0	0.100	0.4	0.040
					5	P	1.2	0.060	0.7	0.035
					1	P	3.0	0.030	2.0	0.020
					0.2	P	17.5	0.035	10	0.020
					1	D	6.0	0.060	7.0	0.070
LH-747041	1	■	5-120	0.10	120	P	0.5	0.60	0.15	0.18
					60	P	0.7	0.42	0.2	0.12
					12	P	2.0	0.24	1.0	0.12
					5	P	5.5	0.275	2.5	0.125
					12	D	4.0	0.48	4.0	0.48
LH-747061	1	■	10-300	0.20	300	P	0.5	1.50	0.15	0.45
					150	P	0.6	0.90	0.2	0.30
					30	P	1.5	0.45	0.8	0.24
					10	P	5.0	0.50	2.4	0.24
					30	D	3.0	0.90	3.0	0.90
LH-747081	1	■	50-1,000	1.00	1,000	P	0.45	4.5	0.15	1.5
					500	P	0.6	3.0	0.2	1.0
					100	P	2.0	2.0	0.5	0.5
					50	P	4.0	2.0	1.0	0.5
					100	D	2.5	2.5	2.0	2.0

*P = Pipetting mode

D = D mode for Multi Dispensing.

The systematic and random measurement deviations listed here apply for ten measurements taken at 10% of the nominal volume.

** Note: the values listed for the systematic and random measurement deviations can only be achieved under strictly controlled conditions during type examinations in accordance with ISO 8655. Due to continuous product development, Sartorius reserves the right to change these values without prior notification.

Channel	Colour of the operating button	Volume range	Increment	Test volume	Mode*	Systematic error ±		Random error ± ±**			
						Unit	Unit	Unit	Unit		
						µl	µl	%	µl	%	µl
						Value	Value	Value	Value	Value	Value
LH-747101	1	■	100-5,000	5.00	5,000	P	0.5	25	0.15	7.5	
					2,500	P	0.7	17.5	0.2	5	
					500	P	1.6	8	0.4	2	
					100	P	8.0	8	2.0	2	
					500	D	2.4	12	2.4	12	
LH-747111	1	■	500-10,000	10.00	10,000	P	0.6	60	0.2	20	
					5,000	P	0.9	45	0.3	15	
					1,000	P	3.0	30	0.6	6	
					500	P	7.0	35	1.2	6	
					1,000	D	4.0	40	2.4	24	

*P = Pipetting mode

D = D mode for Multi Dispensing.

The systematic and random measurement deviations listed here apply for ten measurements taken at 10% of the nominal volume.

** Note: the values listed for the systematic and random measurement deviations can only be achieved under strictly controlled conditions during type examinations in accordance with ISO 8655. Due to continuous product development, Sartorius reserves the right to change these values without prior notification.

14.12.2 Models LH-747321 | LH-747341 | LH-747361 | LH-747391 | LH-747421 | LH-747441 | LH-747461 | LH-747491

Channel	Colour of the operating button	Volume range	Increment	Test volume	Mode*	Systematic error ±		Random error ± ±**		
						Unit	Unit	Unit	Unit	
						µl	µl	µl	µl	
						Value	Value	Value	Value	
LH-747321 LH-747421	8 12	■	0.2-10	0.01	10	P	1.2	0.120	0.5	0.050
					5	P	1.5	0.075	0.8	0.040
					1	P	4.0	0.040	3.0	0.030
					0.2	P	25.0	0.050	15.0	0.030
					1	D	12.0	0.120	15.0	0.150
LH-747341 LH-747441	8 12	■	5-120	0.10	120	P	0.6	0.72	0.3	0.36
					60	P	0.8	0.48	0.4	0.24
					12	P	2.5	0.30	1.67	0.20
					5	P	6.0	0.30	4.0	0.20
					12	D	4.5	0.54	8.0	0.96
LH-747361 LH-747461	8 12	■	10-300	0.20	300	P	0.6	1.80	0.2	0.60
					150	P	0.8	1.20	0.3	0.45
					30	P	2.33	0.70	1.0	0.30
					10	P	8.0	0.80	3.0	0.30
					30	D	3.33	1.00	6.0	1.80
LH-747391 LH-747491	8 12	■	50-1,200	1.00	1,200	P	0.6	7.2	0.2	2.4
					600	P	1.0	6.0	0.3	1.8
					120	P	2.5	3.0	1.0	1.2
					50	P	8.0	4.0	2.4	1.2
					120	D	3.33	4.0	3.33	4.0

*P = Pipetting mode

D = D mode for Multi Dispensing.

The systematic and random measurement deviations listed here apply for ten measurements taken at 10% of the nominal volume.

** Note: the values listed for the systematic and random measurement deviations can only be achieved under strictly controlled conditions during type examinations in accordance with ISO 8655. Due to continuous product development, Sartorius reserves the right to change these values without prior notification.

14.13 Speed Table

14.13.1 1-channel Pipette

		10 µl	120 µl	300 µl	1,000 µl	5,000 µl	10,000 µl
Speed*	Unit	Value	Value	Value	Value	Value	Value
1	s	2.5	6.0	7.7	10.1	10.2	10.2
2	s	1.8	4.2	5.3	7.4	7.4	7.4
3	s	1.3	2.9	3.7	5.4	5.4	5.4
4	s	1.0	2.1	2.7	3.8	3.8	3.8
5	s	0.8	1.5	1.9	2.8	2.7	2.9
6	s	0.6	1.1	1.4	1.9	1.8	2.2
7	s	0.5	0.9	1.1	1.2	1.1	1.7
8	s	0.4	0.7	0.9	0.8	0.8	1.3
9	s	0.3	0.6	0.8	0.6	0.6	0.9

* The speed is measured in pipetting mode with maximum volume. The speed is graduated from 1 (slow) to 9 (fast). In all main operating modes, the speed can be set separately for aspiration and dispensing.

14.13.2 Multi-channel Pipette

		10 µl	120 µl	300 µl	1,200 µl
Speed*	Unit	Value	Value	Value	Value
1	s	2.5	6.1	5.4	6.1
2	s	1.8	4.4	3.9	4.4
3	s	1.3	3.3	2.9	3.3
4	s	1.0	2.4	2.1	2.5
5	s	0.8	1.8	1.6	1.9
6	s	0.6	1.4	1.2	1.4
7	s	0.5	1.1	1.0	1.1
8	s	0.4	0.9	0.8	0.9
9	s	0.3	0.7	0.7	0.7

* The speed is measured in pipetting mode with maximum volume. The speed is graduated from 1 (slow) to 9 (fast). In all main operating modes, the speed can be set separately for aspiration and dispensing.

15 Accessories and Consumables

15.1 Accessories

This table contains an excerpt of the accessories that can be ordered. For information on further items, contact Sartorius.

Item	Quantity	Order number
Charging devices		
Charging stand for 1 pipette with universal charger	1	730981
Charging carousel for 4 pipettes with universal charger	1	730991
USB charging adapter	1	LH-735001
Storage option (non-charging)		
Pipette stand for all Sartorius pipettes	1	725620
Holder for 1 pipette	1	LH-727640
Elbow pad	1	723103
Reagent container (capacity 120 ml)	1	783500

15.2 Consumables

This table contains an excerpt of the consumables that can be ordered. For information on further items, contact Sartorius.

Item	Quantity	Order number
Optifit Tips, 0.1–10 µl, single rack	1	790010
Optifit Tips, 0.1–10 µl, refill pack	1	790013
Optifit Tips, 0.1–10 µl, refill tower	1	790011
Safetyspace® Filter-Tip, 0.1–10 µl, single rack	1	790011F
Safetyspace® Filter-Tip, 0.2–120 µl, single rack	1	790101F
Safetyspace® Filter-Tip, 50–1,000 µl, single rack	1	791001F
Extended Standard Tip, 0.1–10 µl, single rack	1	783210
Extended Standard Tip, 50–1,200 µl, single rack	1	791210
Extended Filter Tips 0.1–10 µl, single rack	1	783201
Extended Filter Tips 10–1,000 µl, single rack	1	LH-XF781001
Safe-Cone Filter, standard, Ø6.73 mm	50	721005
Safe-Cone Filter, standard, Ø5.33 mm	50	721006
Safe-Cone Filter, standard, Ø3.15 mm	50	721007

Item	Quantity	Order number
Safe-Cone Filter, standard, Ø2.51 mm	50	721008
Safe-Cone Filter, standard, Ø1.83 mm	50	721014
Tweezers for filter replacement	1	721009

16 Sartorius Service

Sartorius Service would be happy to help with any queries about the device. For information on the Service addresses, Service services and on the local contact, see the Sartorius website (www.sartorius.com).

If you have queries about the system or are getting in touch in the event of malfunctions, have the device information to hand and give it to Sartorius Service, e.g. serial number, hardware, firmware, configuration. To do this, note the information on the manufacturer's ID label and in the "Settings"/"Information" menu.

17 Documents on Conformity

In the following, the compliance of the device with the designated directives or standards is declared.

EU/EC Declaration of Conformity

Manufacturer	Sartorius Biohit Liquid Handling Oy Laippatie 1, 00880 Helsinki, Finland	
	We hereby declare under our sole responsibility that the following product	
Name	Picus® 2	
Modell(s)	LH-747021, LH-747041, LH-747061, LH-747081, LH-747101, LH-747111, LH-747321, LH-747341, LH-747361, LH-747391, LH-747421, LH-747441, LH-747461, LH-747491	
Device type	Electronic pipette	
	in the form as delivered fulfils all the relevant provisions of the following European Directives – including any amendments valid at the time this declaration was signed - and meets the applicable requirements of the harmonized European Standards including any amendments valid at the time this declaration was signed - listed below:	
2014/53/EU	Directive on Radio Equipment EN 300 328 V2.2.2 EN 301 489-17 V3.2.4	
2014/30/EU	Directive on Electromagnetic Compatibility EN 61326-1:2013 EN 301 489-1 V1.9.2	
2011/65/EU	Restriction of the use of certain hazardous substances in electrical and electronic equipment (RoHS) (incl. (EU) 2015/863) EN IEC 63000:2018	
Accessories	Charging Stand	730981
	Charging Carousel	730991
	Picus® AC Adapter	LH-735001
	Sartorius Pipetting mobile application	

UK Declaration of Conformity

Manufacturer Sartorius Biohit Liquid Handling Oy
Laippatie 1, 00880 Helsinki, Finland

We hereby declare under our sole responsibility that the following product

Name Picus® 2

Modell(s) LH-747021, LH-747041, LH-747061, LH-747081, LH-747101, LH-747111, LH-747321, LH-747341, LH-747361, LH-747391, LH-747421, LH-747441, LH-747461, LH-747491

Device type Electronic pipette

in the form as delivered fulfils all the relevant provisions of the following UK Regulations and meets the applicable requirements of the UK Designated Standards including any amendments valid at the time this declaration was signed listed below:

The Radio Equipment Regulations 2017
UK Statutory Instruments 2017 No. 1206
EN 300 328 v. 2.2
EN 301 489-17 V3.2.4

The Electromagnetic Compatibility Regulations 2016
UK Statutory Instruments 2016 No. 1091
BS EN 61326-1:2013
EN 301 489-1 V1.9.2

The Restriction of the Use of Certain Hazardous Substances in Electrical and Electronic Equipment Regulations 2012 (RoHS)
UK Statutory Instruments 2012 No. 3032
BS EN 50581:2012, BS EN 61010-1:2010

Accessories	Charging Stand	730981
	Charging Carousel	730991
	Picus® AC Adapter	LH-735001
	Sartorius Pipetting mobile application	

ANATEL

The device contains ANATEL approved module. The approval number is 00857-21-05903.

IMDA Standards

**Complies with
IMDA Standards
DA105282**

The device complies with IMDA standards: DA105282.

18 Trademark Information

18.1 Bluetooth®

Bluetooth® is a registered trademark of Bluetooth SIG, Inc..

Sartorius Biohit Liquid Handling Oy
Laippatie 1
00880 Helsinki, Finland

Phone: +358 9 75 59 51
www.sartorius.com

The information and figures contained in these instructions correspond to the version date specified below.

Sartorius reserves the right to make changes to the technology, features, specifications and design of the equipment without notice.

Masculine or feminine forms are used to facilitate legibility in these instructions and always simultaneously denote all genders.

Copyright notice:

These instructions, including all components, are protected by copyright.

Any use beyond the limits of the copyright law is not permitted without our approval.

This applies in particular to reprinting, translation and editing irrespective of the type of media used.

Last updated:

06 | 2023

© 2023

Sartorius Biohit Liquid Handling Oy
Laippatie 1
00880 Helsinki, Finland

SP | Publication No.: WPI6002-e230601