

Cole-Parmer®

RS-200 Series

Omni Reaction Station



Instruction Manual
M7886 Version 8.5

Cole-Parmer®
essentials

Please take your time to read this Instruction manual in order to understand the safe and correct use of your new Cole-Parmer product.

It is recommended the responsible Body for the use of this equipment reads this instruction manual and ensures the user(s) are suitably trained in its operation.

Contents	Page
Section 1 Introduction	3
Section 2 Symbols and using this Instruction manual	4
Section 3 Safety Information	5
Section 4 Unpacking and Contents	8
Section 5 Installation	9
Section 6 Environmental Protection	10
Section 7 Equipment Operation	11
Section 8 Technical Specification	26
Section 9 Maintenance	28
Section 10 Spares and Accessories	30
Section 11 Customer and Technical Support	31
Appendix 'A' Stem	32
Declaration of Conformity	34

© The copyright of this instruction manual is the property of Antylia Scientific Limited. This instruction manual is supplied by Antylia Scientific Limited on the express understanding that it is to be used solely for the purpose for which it is supplied. It may not be copied, used or disclosed to others in whole or part for any purpose except as authorised in writing by Antylia Scientific Limited. Antylia Scientific Limited reserves the right to alter, change or modify this document without prior notification.

In the interest of continued development Antylia Scientific Limited reserve the right to alter or modify the design and / or assembly process of their products without prior notification.

This product is manufactured in Great Britain by Antylia Scientific, part of the Antylia Scientific Group of companies.

Antylia Scientific Ltd.

Beacon Road,
Stone,
Staffordshire,
ST15 0SA,
United Kingdom
Tel: +44 (0)1785 812121

Note: All illustrations in this document are for reference only

1. INTRODUCTION

- 1.1. Your Cole-Parmer Omni Reaction Station has been designed to provide a comprehensive answer to heating/cooling and stirring fluids in various vessel formats. This product is modular in design allowing for complete interchange ability between dry blocks of various capacities. With its 'easy to read/easy to operate' revolutionary CTC (Capacitance Touch Control) panel, setting the required temperature and stir speed takes only seconds.
- 1.2. Heating is controlled by a modern 'state of the art' microprocessor, which displays the heat setting as a percentage of the total power. When the temperature probe is fitted, the heating is controlled via the temperature feedback circuit and the actual temperature is displayed. All new dry blocks come with an in-built temperature sensor. This allows the true block temperature to be viewed at all times. When using a probe and dry block with in-built sensor, the temperature displayed is that as measured by the probe.
- 1.3. An 'all new' digital controller and motor arrangement allow for accurate, low speed stirring control. Uniform stirring is provided via a motorised rotating magnet assembly positioned to provide maximum magnetic flux linkage to rotate the stirrer bars in each reaction vessel.
- 1.4. Cooling ability is provided by means of a cooling plug*. The cooling plug is inserted into the core of the dry block. Chilled water or other liquid heat transfer medium is circulated through the cooling plug to provide an effective heat transfer. A dry block can be cooled from ambient to a defined lower temperature by use of a cooling plug, depending on the temperature of the re-circulated cooling fluid. A previously heated block may be cooled down rapidly using the cooling plug in order to reduce cycle times.
- 1.5. Sample losses from condensation can be prevented by using the reflux unit. The facility to purge your samples using an external gas supply is facilitated within your reflux unit. A common gas input together with multiple outputs allow for each reaction position to be individually purged.

*Optional accessory

2. SYMBOLS AND USING THIS INSTRUCTION MANUAL

- 2.1. Throughout this Instruction manual the following symbols are shown to identify conditions which pose a hazard to the user or to identify actions that should be observed. These symbols are also shown on the product, or its packaging. When a symbol is shown next to a paragraph or statement it is recommended the user takes particular note of that instruction in order to prevent damage to the equipment or to prevent injury to one's self or other people.

The Responsible Body and the Operator should read and be familiar with this Instruction manual in order preserve the protection afforded by the equipment.

To prevent injury or equipment damage it is the manufacturer's recommendation that all persons using this equipment are suitably trained before use.

2.2. Symbols Defined



Caution, risk of danger. See note or adjacent symbol.



Protective conductor terminal to be earthed.
Do Not loosen or disconnect.



Caution / risk of electric shock



Recyclable Packing Material



Do not dispose of product in normal domestic waste.



Caution. Hot surface.



Refer to Operator Instruction Manual.



Stirring Facility On / Off



Heating Facility On / Off



Bio Chemical Hazard. Caution required. Will require decontamination.

3. SAFETY INFORMATION



This product has been designed for safe operation when used as detailed in accordance with the manufacturer's instructions.



 **ATTENTION:-** The product will not restart after a mains electrical supply interruption once the supply has been returned.



NOTE: Failure to use this equipment in accordance with the manufactures operating instructions may compromise your basic safety protection afforded by the equipment and may invalidate the warranty / guarantee. The warranty / guarantee does not cover damaged caused by faulty installation or misuse of the equipment.

3.1. Prevention of Fire and Electric shock.

  To prevent a risk of fire or electric shock, **do not** open your product case without authorisation. Only Qualified Service Personnel should attempt to repair this product.

  Replace fuses only with the type as listed in section, 'Technical Specification and Parts and Accessories' (See fuse type and rating).

  Ensure the mains power supply conforms to the rating found on the data plate located on the back of the base controller of this Omni Reaction Station.

  **Never** operate this equipment with out connection to earth / ground. Ensure the mains supply voltage is correctly earthed / grounded in accordance with current area legislation.

3.2. General Safe Operating Practice.

 Always follow good laboratory practice when using this equipment. Give due recognition to your company's safety and legislative health & safety procedures and all associated legislation applicable to your areas of operation. Check laboratory procedures for substances being heated and ensure all hazards (e.g. explosion, implosion or the release of toxic or flammable gases) that might arise have been suitably addressed before proceeding. When heating certain substances the liberation of hazardous gases may require the use of a fume cupboard or other means of extraction.

 Ensure the equipment is used on a clean, dry, non-combustible, solid work surface with at least 300mm suitable clearance all around from other equipment.















 **Do not** position the product so that it is difficult to disconnect from the mains supply.

 **Do not** touch the heating element, dry block, cooling plug, reflux unit, hoses or any glass vessel whilst in use.

 **Do not** leave a disconnected cooling plug in a dry block whilst heating. Pressure may build up inside the cooling plug from previously used coolant and may eject hot coolant under pressure.

 **Do not** lean or stretch over equipment, glassware and fixings when in use.

 **Do not** immerse unit in water or fluids.

-  **Do not** use in hazardous atmospheres or with hazardous materials for which the equipment is not designed
-  **Do not** spill substances onto the dry block. If spillage does occur, disconnect the unit from the mains supply and follow instructions as detailed in Section 9.3 Decontamination.
-  **Do not** cover the dry block cartridge whilst in use.
-  **Do not** leave equipment switched on without a charged flask(s).
-  **Do not** install or remove the dry block cartridge from the control unit whilst power is applied to the controller.
-  **Do not** thermally insulate the exposed upper section of the vessel(s), as the insulation used may obstruct the convection cooling airways around the rim of the cartridge enclosure and cause the dry block to overheat.
-  It is not recommended to leave any heating apparatus unattended during operation.
-  Only use Original Equipment manufactures spares and accessories. Ref Section 10.
-  This equipment employs the use of rotating magnets. Keep all metal objects and magnetic data devices (credit cards) away from the stirrer unit.
-  The equipment is not spark, flame or explosion proof and has not been designed for use in hazardous areas in terms of BSEN 60079-14:1997. Keep flammable, low flash point substances away from the apparatus.
-  **Do not** operate or handle any part of this product with wet hands. Keep the mains cord and moulded IEC plug and lead set away from the heating surface.
-  **Warning:** Glass vessels can explode or implode violently, either spontaneously from stress failure caused by pressure or vacuum, or from accidental impact. Carefully check glass vessels for star cracks, scratches or etching marks before each use. Cracks can increase the likelihood of breakage or may allow chemicals to leak into the equipment. Conduct pressure and vacuum operations in glass vessels behind adequate shielding and use Personnel Protective Equipment (full face guard, gloves, protective clothing) during handling.
-  **Warning:** Standard glassware supplied for the Omni Reaction Station is not designed for high pressure applications. **Maximum operating pressure of standard glassware with inerting cap fitted is 0.5bar.**
-  **ATS10075 24mm diameter glassware:** Borosilicate glass, 1.6mm wall thickness. General glassware **is not** pressure tested.

Risk assessment is required by the user to ensure adequate safety precautions/use of, screens, hoods, PPI etc. for processes being operated with due regard to use of glassware at pressures other than atmospheric.

Tests undertaken on sample new glassware at ambient temperature, assembled with ATS10377 inerting cap, (tested under water) indicate it can withstand pressure of 0.5 bar gauge.

Warning: When the inerting cap is fitted, the septum cap acts as a pressure relief valve which can open suddenly and blow out (with some velocity) at pressures approaching 2 bar gauge. (NB: Sampling probes inserted through Septum cap may restrict this pressure relief action).

For high pressure applications, please contact :
cptechsupport@antylia.com

3.3 Additional Safety Information for the ATS10377 Inerting Cap

Viton (main seal and o rings)	Viton is resistant to a wide range of chemicals including oils, aqueous media and most other fluids. It is recommended to check for specific chemicals by reference to an internet search engine. Numerous web sites give data on Viton chemical resistance. http://www.dupontelastomers.com/Products/Viton/viton.asp
PFTE cap and valve spindle	PTFE is resistant to a wide range of chemicals, including ozone, chlorine, acetic acid, ammonia sulphuric acid and hydrochloric acid. The only chemicals known to affect these coatings are molten alkali metals and highly reactive fluorinating agents. It is recommended to check for specific chemicals by reference to an internet search engine. http://www2.dupont.com/Teflon_Industrial/en_US/tech_info/prodinfo_ptfe.html
Silicone cap septum	Peroxide cross linked HTV silicone rubber, classified in accordance with ASTM D 1418 as VMQ. It is recommended to check for specific chemicals by reference to an internet search engine.
316 Stainless steel gas nozzle	It is recommended to check for specific chemicals by reference to an internet search engine.
316 Stainless steel 2mm diameter sampling hole bung	It is recommended to check for specific chemicals by reference to an internet search engine.

4. UNPACKING AND CONTENTS

Please check the contents of this carton against the diagram for your variation of Omni Reaction Station kit.

The basic variations between each type of kit consist of the following:

OS1025, European, UK & 230V

RS-200D-115, USA and Canada, 115V

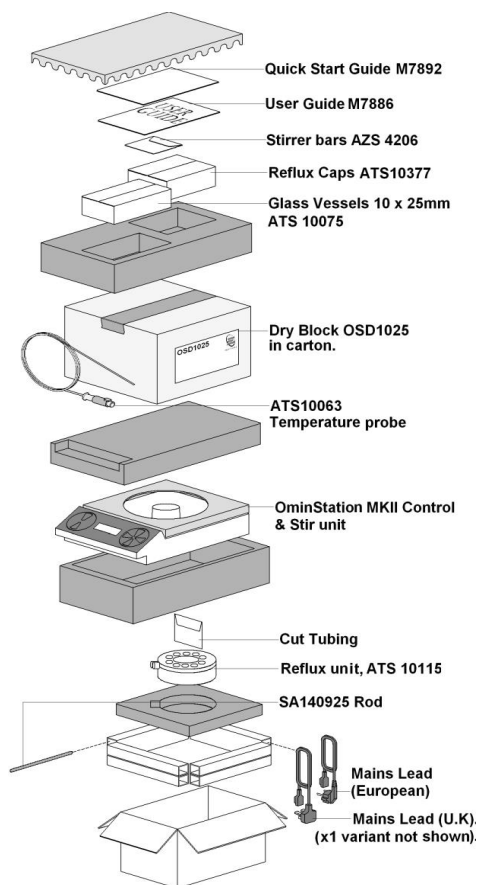

Figure 1: RS-200D(-115) Kit Contents

Quantity	Item	Part code
1	Quick start guide	M7892
1	User guide	M7886
10	Glass vessels	ATS10075
1 x 10	Boxed reflux caps	ATS10377
2	Mains cord and moulded IEC plug and lead set (EU/UK) RS-200D or HH179(S) (UK) HH180(S) (EU)	
1	Mains cord and moulded IEC plug and lead set (US/Canada) RS-200D-115	CRM6288
1 x 10	Bagged stir bars	AZS4206
1	Dry block (EU/UK) or OSD1025	OSD1025
1	Dry block (US/Canada) OSD1025X1	OSD1025X1
1	Omni Station controller (EU/UK) or OSCA/OMCA	OSCA/OMCA
1	Omni Station controller (US/Canada) OSCA/OMCAX1	OSCA/OMCAX1
1	Reflux unit	ATS10115
1	Temperature probe	ATS10063
1	Packet of cut tube	SA1409141





For your future reference please record your product's Serial and Model numbers:

<i>Controller Serial Number</i>	<i>Controller Model Number</i>
<i>Dry Block Serial Number</i>	<i>Dry Block Model Number</i>
<i>Reflux Unit Serial Number</i>	<i>Reflux Unit Model Number</i>



5. INSTALLATION

5.1. Electrical safety and Installation

5.1.1 This equipment is designed for safe operation under the following conditions:-

- Indoor use.
 - Altitude up to 2000 meters.
 - Temperatures between 5°C and 40°C.
 - Maximum relative humidity 80% for temperatures up to 31°C decreasing linearly to 50% relative humidity at 40°C.
 - Mains supply voltage fluctuations up to $\pm 10\%$ of the nominal voltage.
 - Transient overvoltages typically present on the mains supply. (Overvoltage category II).
 - Applicable rated pollution degree 2.
- 5.2.  This equipment must be earthed / grounded to a fixed earth / grounded mains socket outlet. The mains supply is to be earthed / grounded in accordance with current legislation.
- 5.3. Ensure only the correct rated mains input fuses are fitted. (Where applicable ensure the correct Mains cord and moulded IEC plug and lead set fuse if fitted). See Technical Specification Section 8 of this Instruction manual.
- 5.4. Check the input voltage on the product data label of your Omni Reaction Station unit and dry block. Ensure the rating conforms to your local supply.
- 5.5. It is recommended the Omni Reaction Station be connected to a mains supply source which incorporated a RCD or GFCI device.
- 5.6.   Do not install the Omni Reaction Station controller and dry block on a surface which may become flooded due to the poor condition of a chilled water supply.
- 5.7. The unit is supplied with a moulded mains cord and plug set wired as follows:-
Green /Yellow or Green = Earth / Ground 
Blue or White = Neutral
Brown or Black = Live / line hot.

6. ENVIRONMENTAL PROTECTION

- 6.1. Maximum consideration has been given to environmental issues within the design and manufacturing process without compromising end product performance and value.
- 6.2.  Packaging materials have been selected such that they may be sorted for recycling.
- 6.3.  At the end of your product and accessories life, it must **not be** discarded as domestic waste. Ref: EU Directive 2002/96/EC on Waste Electrical and Electronic Equipment Directive (WEEE). Please contact your distributor / supplier for further information. For end users outside of the EU consult applicable regulations.
- 6.4. This product should only be dismantled for recycling by an authorised recycling company.



This product and accessories must be accompanied by a completed Decontamination Certificate prior to any Disposal. Copies of the Certificate are available from Distributor/Manufacturer.

7. EQUIPMENT OPERATION

7.1 Overview

Your Omni Reaction Station has been designed for easy operation. The illustrations show a detailed front and rear view of your Omni Reaction Station control unit. They also show a detailed view of the keypad and LCD screen.

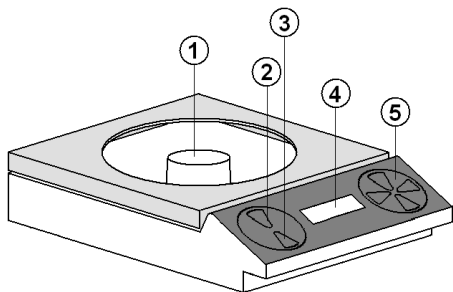

Figure 5

- 1 Magnetic stir hub
- 2 Stir activation key
- 3 Heater activation key
- 4 LCD display
- 5 Menu selection keys

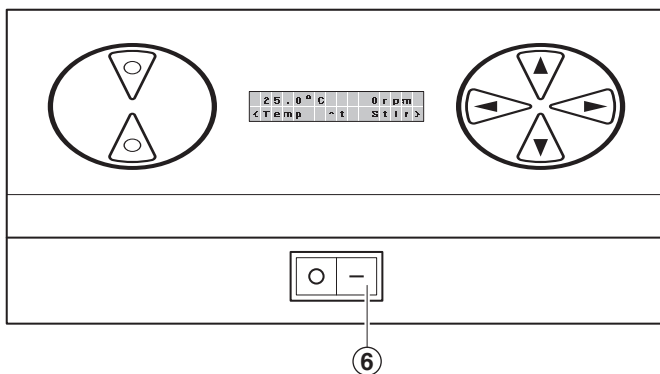

Figure 6

- 6 On / off power switch

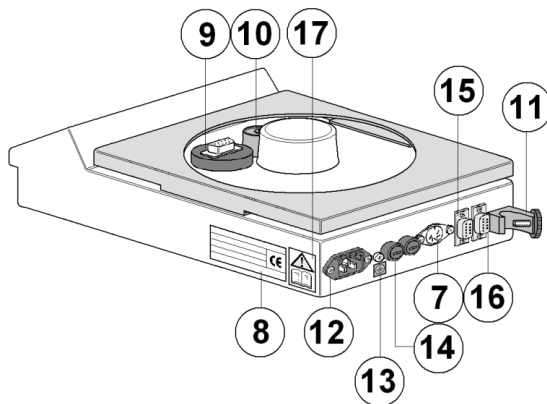

Figure 7

- 7 External probe socket
- 8 Date plate label
- 9 Dry block control plug
- 10 Dry block power supply socket
- 11 Vertical rod clamp fastening bracket
- 12 Mains input IEC socket
- 13 Earth test point
- 14 Fuses
- 15 RS232 Aux communication
- 16 RS232 Data communication
- 17 Read instruction book

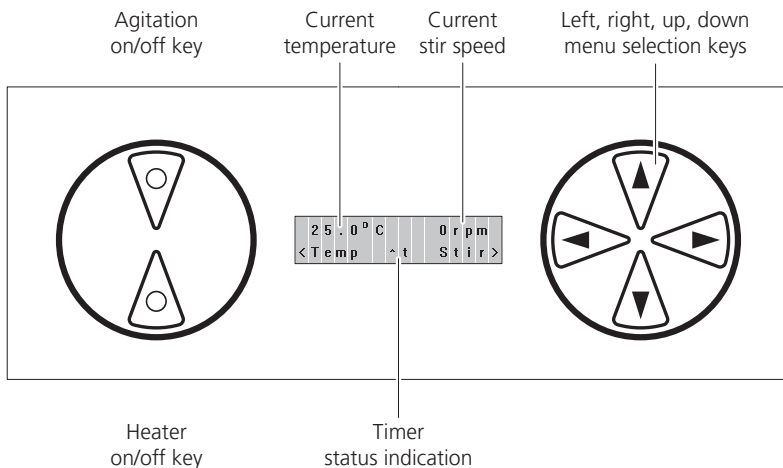

Figure 8

7.2. Support Rod

The Omni Reaction Station base controller incorporates a vertical rod support bracket. The rod is to be screwed fastened into the bracket. Glass arrangements are to be secured in conjunction with appropriate clamp and flask support when using a dry block.

7.3. Fitting a Dry Block

7.3.1. Fitting a dry block is achieved by aligning the 9 pin plug of the dry block with the 9 pin socket.

7.3.2. Carefully lower the dry Block into the control unit ensuring the tabs on the controller align with the grooves in the base of the dry block or mantle ensuring positive engagement.

7.3.3. If required, insert the external sample temperature probe plug into the external probe socket.



WARNING.

Care should be exercised when handling a hot dry block.



WARNING.

Ensure the mains electricity supply is turned off and disconnected before fitting / removing a dry block.

7.4. Power On and Front Screen Menu

7.4.1. Connect the mains cord and moulded IEC plug and lead set cable supplied with the Omni Reaction Station into the mains power inlet socket (See Figure 7: Omni Reaction Station Control Unit - Rear View). Press the On / Off switch (See Figure 6: Keypad and LCD Screen) to the on position.

7.4.2. The LCD display will go through a warm and self-check routine that will take a few seconds during which the Omni Reaction Station software revision will be displayed for 5 seconds before confirmation. Upon completion of the routine the Omni Reaction Station LCD will then display the type of heating apparatus being used. (See Figure 9: LCD Display of Apparatus Being Used).

Note: All function selections and settings are made using the menu keys. The keys are indicated using **<^>** symbols in the LCD display.

Press the right hand menu key **>** to confirm correct module.



Figure 9: LCD Display of Apparatus Being Used

If the error message **'Module Missing'** is displayed, turn off the Omni Reaction Station unit. Insert a dry block or ensure the existing module is correctly seated.



Figure 10: 'Module Missing' Error Message

If you are using an older type of dry block (version without internal temperature sensor) the main menu screen will look like the illustration.



Figure 11: No Internal Temperature Sensor (Old Dry Block Design)

If you are using a new design of dry block the main screen menu will look like the illustration.

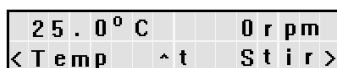

Figure 12: Internal Temperature Sensor (New Dry Block Design)

If you have the external probe attached for measuring sample solution content the main screen menu will look like Figure 13: External Temperature Probe Attached below. Note the

e character next to the temperature display when external probe is connected.

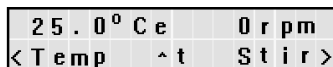

Figure 13: External Temperature Probe Attached

7.5. Stir Speed Setting and Activation

From the main display screen menu press the **>** key to enter the 'stir speed' setting screen.

Note: The stir speed displayed is that of the last setting made by the user.



Figure 14: Stir Speed

Press the **>** key to enter the stir speed selection screen.

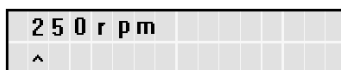

Figure 15: Setting the Stir Speed (Image 1)

Press the **^** key to make the 100's value selection. Press the **v** key if you wish to reduce the selected stir speed value.

Press the **>** key to go into the 10's selection screen.

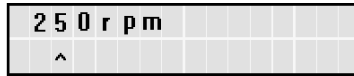

Figure 16: Setting the Stir Speed (Image 2)

Press the **^** key to make the 10's value selection. Press the **V** key if you wish to reduce the selected stir speed value.

Press the **>** key to return to the front screen menu.

OR.....

If 10 seconds elapse without a key being pressed the display will return to the main display menu.

Note: There is no facility for setting the units stir speed value.

To start the stirring process press the stir key marked with the symbol: 

To stop the stirring process press the stir key once more.

Note: To show stirring is in operation the stir symbol will remain illuminated. The stir speed shown on the LCD is the *true speed* of stir. Not the setting.

7.6. Heat Setting and Activation

7.6.1. Setting the temperature when using a dry block without an internal sensor.

From the main display menu screen press the **<** key to go into the 'heat setting' screen.

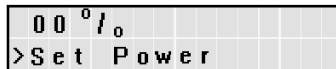

Figure 17: Setting the Power

Note: The default setting will always display 00%. Previous power settings are not retained.

Press the **>** key to go into set power selection screen.

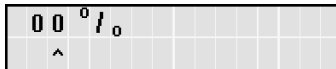

Figure 18: Making the % Power Selection

Press the **^** key to make the % power selection. Press the **V** key if you wish to reduce the power selection.

Note: The power settings are made in increments of 5°C. The power selection range is from 0 to 100%.

Press the **>** key to return to the front screen menu.

OR.....

If 10 seconds elapse without a key being pressed the display is to return to the main display menu.

To start the heating process press the heating key marked with the symbol: 

To stop the heating process, press the heating key once more.

Note: To show heating is in operation the heat symbol will remain illuminated. The power percentage shown on the LCD is that of the setting.

7.6.2. Setting the temperature when using a dry block with an internal sensor.

From the main display menu screen press the **<** key to go into the 'temperature setting' screen.

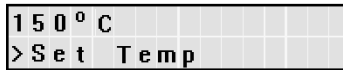

Figure 19: Temperature

Note: The stir temperature displayed is that of the last setting made by the user.

Press the **>** key to go into temperature selection screen.

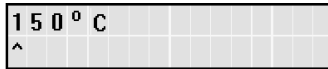

Figure 20: Setting the Temperature (Image 1)

Press the **^** key to make the 100's temperature value selection. Press the **v** key if you wish to reduce the selected temperature value.

Press the **>** key to go into the 10's temperature selection screen.

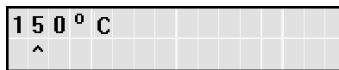

Figure 21: Setting the Temperature (Image 2)

Press the **^** key to make the 10's temperature value selection. Press the **v** key if you wish to reduce the selected temperature value.

Press the **>** key to go into the units temperature selection screen.

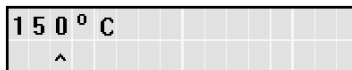



Figure 22: Adjusting the Temperature Setting

Press the **^** key to make the units temperature value selection. Press the **v** key if you wish to reduce the selected temperature value.

Press the **>** key to return to the front screen menu.

OR.....

If 10 seconds elapse without a key being pressed the display will return to the main display menu.

To start the heating process press the heating key marked with the symbol: 

To stop the heating process press the heating key once more.

Note: To show heating is in operation the heat symbol will remain illuminated. The actual temperature shown on the LCD is that measured by the internal dry block sensor.

Note: During the heat up process the  will flash to indicate the set temperature has not been reached. Once the set temperature has been reached the flashing symbol will remain constantly illuminated. To accommodate over / under temperature oscillation the symbol will not recommence flashing until the temperature is $\pm 5^{\circ}\text{C}$ off of the set temperature.

Note: When used with internal or external probe the temperature range setting for a dry block is -30°C to 220°C settable in increments of 1°C . To achieve a temperature less than that of ambient the optional cooling plug accessory must be used with a chilled fluid supply less than that of the required minimum temperature.

7.6.3. Setting the temperature when using a dry block with an external probe.

Note: With the external probe attached an **e** symbol will appear in the LCD next to the temperature reading indicating the connection of the external probe (See Figure 13: External Temperature Probe Attached). The temperature reading displayed is that read by the probe. An external probe will override the temperature controlled by any dry block internal sensor.

The external probe is to be placed in the sample solution. Heating your sample is now controlled via the external probe.

Temperature settings are made in the same way as described in Section 7.6.2.

7.7. Timer Operation

Your Omni Reaction Station has the facility to set a countdown timer which will switch off the heaters after a pre-set time period. The timer can be set for up to 99 hours 59 minutes.

Set the required heating temperature as described in Section 7.6.

From the main display screen press the **^** key to enter 'time set' mode.

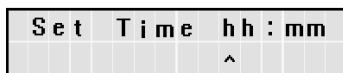

Figure 23: 'Time Set' Mode

Press the **^** to make the 10's hours selection. Pressing the **v** will reduce the selection.

Note: Once a time digit has been set all the remaining time set digits will default to zero until they are set.

Press the **>** key to go into the unit hours selection.

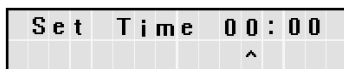

Figure 24: Select Hours

Press the **^** to make the unit hours selection. Pressing the **V** will reduce the selection.

Press the **>** key to go into the 10's minutes selection.

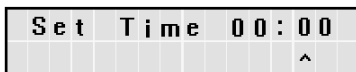

Figure 25: Select Minutes

Press the **^** to make the 10's minutes selection. Pressing the **V** will reduce the selection.

Press the **>** key to return to the front screen menu.

OR.....

If 10 seconds elapse without a key being pressed the display is to return to the main display menu.

Note: There is no setting facility of setting unit minutes.

To start the heating process press the heating key marked with the symbol: 

The timer will not commence count down until the heaters are activated.

With the timer set the front screen will display count down hours indicated with an **h** symbol next to the time display.

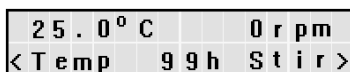

Figure 26: Count Down Hours

When only minutes remain on the time counter the display will switch over to a minutes count and the **m** symbol will be displayed next to the time display.

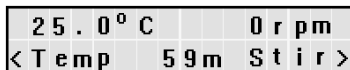



Figure 27: Count Down Minutes

When the timer counter reaches zero the heaters are turned off. The  key illumination is extinguished and the main display screen reverts to **^t**. A one second 'beep' is sounded when the heaters are turned off in timer mode.

Note: At any time during the use of the timer facility the heaters may be turned off manually using the  key.

7.8. Keypad Lock / Unlock

To prevent accidental switching of functions or the disturbance of run settings the Omni Reaction Station has a 'Keypad Lock Facility'.

7.8.1. To lock the keypad:

Press the down arrow  key. The display will now instruct you to press the left arrow menu key.

A rectangular LCD display with a grid background. The text is arranged in two lines: the first line reads "To lock keypad" and the second line reads "Press <".

Figure 28: To Lock Keypad

Press the left arrow  key. The display will now instruct you to press the up arrow menu key.

A rectangular LCD display with a grid background. The text is arranged in two lines: the first line reads "To lock keypad" and the second line reads "Press ^".

Figure 29: To Lock Keypad Press Up

Press the up arrow  key. The display will now instruct you to press the right arrow menu key.

A rectangular LCD display with a grid background. The text is arranged in two lines: the first line reads "To lock keypad" and the second line reads "Press >".

Figure 30: To Lock Keypad Press Right

Press the right arrow  key. The display will confirm the keypad is locked.

A rectangular LCD display with a grid background. The text is arranged in one line: "keypad lock".

Figure 31: Keypad Locked

Note: To lock the keypad you have selected all of the arrow menu keys in a clockwise rotation.

7.8.2. To unlock the keypad:

Press the up arrow  key. The display will now instruct you to press the left arrow menu key.



Figure 32: To Unlock Keypad

Press the left arrow < key. The display will now instruct you to press the down arrow menu key.



Figure 33: To Unlock Keypad Press Down

Press the down arrow v key. The display will now instruct you to press the right arrow menu key.



Figure 34: To Unlock Keypad Press Right

Press the right arrow > key. The display will return to standard operational mode.

Note: *To unlock the keypad you have selected all of the arrow menus keys in an anti-clockwise rotation.*

7.9. Errors and Warnings

7.9.1. Warning – external probe unplugged during operation.

If during use the external probe becomes detached from the Omni Reaction Station the following error message will be displayed



Figure 35: Warning - External Probe Unplugged

The unit will 'beep' rapidly for 10 seconds.

The heaters will be turned off.

If the unit was stirring a sample it will continue to do so.

The warning will remain on the LCD until the > key is pressed.

The unit will return to the main display screen for use without the external probe unless the connection is re-established. The heaters must then be turned back on manually by pressing the  key.

7.9.2. Warning – external probe is plugged in but inadvertently left out of the sample.

When an external probe is plugged in and the heaters are turned on your Omni Reaction Station will expect to see a rise in temperature of no less than 6°C within the first 10 minutes. Should the external probe be accidentally left out of the sample solution the following will be displayed:

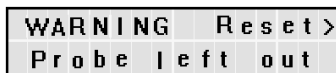

Figure 36: Warning – External Probe Left Out Of Sample

The unit will 'beep' rapidly for 10 seconds.

The heaters will be turned off.

If the unit was stirring a sample it will continue to do so.

The warning will remain on the LCD until the > key is pressed.

Rectify the fault.

The unit will return to the main display screen for use without the external probe unless the connection is re-established. The heaters must then be turned back on manually by pressing the  key.

Note: *If a dry block has no internal sensor fitted, the unit may trip into fault if a temperature is set which is less than 6 °C above the dry block starting temperature. To overcome this situation always set a temperature 6 °C above the dry block starting temperature. Alternatively cool the dry block using the optional cooling plug accessory.*

If the dry block is equipped with an internal sensor and the set temperature is less than 6 °C above the dry block starting temperature the unit will only go in error condition when the internal sensor sees more than a 50 °C increase above the set point with no temperature increase seen on the external probe.

7.9.3. Warning – external probe has fallen out of the sample.

If during the heating cycle the external temperature probe falls out of the sample the following condition will arise:

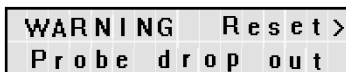

Figure 37: Warning - External Probe Drop Out

Should the external probe fall of the sample the unit will see a decrease in temperature. Once the probe temperature has dropped more than 6°C in 60 seconds the heaters will be turned off.

The unit will 'beep' rapidly for 10 seconds.

If the unit was stirring a sample it will continue to do so.

The warning will remain on the LCD until the ➤ key is pressed.

Rectify the fault.

The unit will return to the main display screen for use without the external probe unless the connection is re-established. The heaters must then be turned back on manually by pressing the  key.

7.9.4. Warning – heating module removed during operation.

If a dry block is removed from the Omni Reaction Station when the unit is powered up the 'Module Missing' screen will be displayed (See Figure 10: 'Module Missing' Error Message). Stirring and heating will stop.

This message will disappear when a dry block is reinstated. The module type will be displayed in the LCD. Press ➤ key to return to the main display screen. Stirring and heating must then be manually turned back on.

7.10. Reflux Accessory 10 Positions

7.10.1. The illustrations show the main components of the 10 way reflux unit.

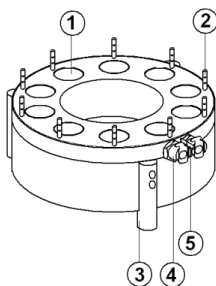

Figure 38: 10 Way Reflux Unit

- 1 Glass vessel port
- 2 Inerting gas out let port.
- 3 Location leg
- 4 Coolant in and return quick release ports
- 5 Inerting gas input port.

Press down on the release buttons of the quick release valves and remove the quick release bars.

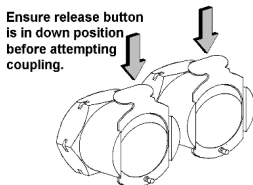

Figure 39: Quick Release Valves

Firmly attach the quick release bars to your chiller supply hoses ensuring a leak free connection.

With the power turned off, ensure the 10 way dry block is placed in the control unit of the Omni Reaction Station.

Note: For 25mm glassware remove the 24mm reduction ring located in the vessel port of the dry block.

Place the reflux unit over the dry block ensuring the legs of the reflux unit sit over the rim of the dry block cartridge.

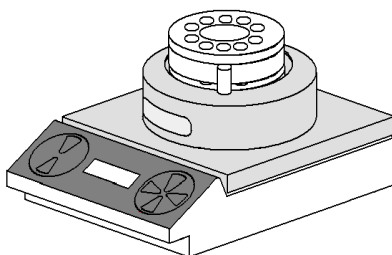

Figure 40: 10 Way Dry Block In-Situ

Connect the coolant supply pipe work to the reflux head using the 'quick release' pipe fittings supplied. The connection is made by inserting the quick release fitting into the elbow joint coupling. Ensure the release button is in the down position before attempting to make the coupling. (See Figure 39: Quick Release Valves).

Note: The chilled coolant supply must not exceed 3 bar pressure. Ensure there is a free flow of coolant through the reflux head. Do not turn on the coolant supply until both hoses have been connected. Condensation will form on the surface of the reflux unit when the coolant supply temperature is lower than that of dew point.

Turn on the coolant supply and check for any signs of coolant leakage. Allow 15 minutes for the reflux head to cool before use.

Charge up to ten vessels with chemistry and add stir bars AZS4206 (one per glass vessel). Screw fasten the reflux caps onto the charged flasks. Ensure the valve taps on each reflux cap is in the closed position.

Note: Using the inerting facility is optional.

Place the charged glass vessels containing the required chemistry into the dry block by lowering them through the reflux unit.

Connect a piece of inert tubing between each inerting cap and reflux gas output port.

Push fit the inerting gas supply pipeline onto the inerting gas inlet port.

Turn on the gas and check for leaks.

Turn on the gas tap for each inerting cap position.

Your Omni Reaction Station is now ready for operation as described at the beginning of this section.

7.11. Cooling Plug (Optional) (10 Way - ATS10114)

The illustration below shows the main components of the cooling plug.

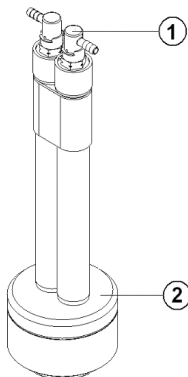

Figure 44: Cooling Plug

- 1 Coolant in and return quick release ports
- 2 Plug.

The cooling plug accessory is specific for the 10 way dry blocks. The cooling plug can be connected to the coolant supply either in or out of the dry block. The plug can be inserted and removed from the dry block whilst the reaction vessels are in the Reaction Station.

The cooling plug has a machined aluminum body which acts as the heat exchange interface between the dry block and the chilled coolant supply. The plug body slides snugly into the dry block, providing a good thermal contact between the cooling plug and dry block.

The coolant is piped through the plug via insulated standpipes terminated with quick-release sealed connectors. Mating right-angled connectors are provided to allow the customer's chilled coolant supply to be linked into the standpipe connectors.



The customer's chilled coolant supply must be below 3 bar pressure. Ensure there is a free flow of coolant through the cooling plug – do not apply coolant flow until the outlet pipe-work has been connected and unobstructed.



The Cooling Plug should only be inserted or removed from the dry block at coolant temperatures **above 0°C**, to prevent icing problems.

The controller display will provide sub-zero temperature readings when the external probe and cooling plug are used in tandem.

WARNING!



Do not leave a disconnected cooling plug in a dry block whilst heating. Pressure may build up inside to cooling plug from previously used coolant and cause a rupture of boiling fluid.

8. TECHNICAL SPECIFICATION

Mains supply voltage	100-115V~AC 50/60 Hz 230V~AC 50/60 Hz
HH179(S)	Mains cord and moulded IEC plug and lead set cable (UK) 10A BS1362
HH180(S)	Mains cord and moulded IEC plug and lead set cable (Europe)
CRM6288	Mains cord and moulded IEC plug and lead set cable (USA)
Maximum load	RS-200D-115 (115V) = 500W OS1025 (230V) = 500W
Stir speed	Min 100 RPM Max 800 RPM
Fuse rating	115V = 7A 32mm x 6.3mm Quickblow 230V = 5A 32mm x 6.3mm Quickblow
Temperature range using cooling plug and reaction station	-30°C to +220°C

Product configuration details

OSCA/OMCA OSCA/OMCAX1	Base Controller with Stirrer.
OSD1025X1 OSD1025	Heater Block 10x25mm

The Ingress protection rating for the dry block and controller has been classified as IPX1.

Dimensions & weight (unpacked) - Controller

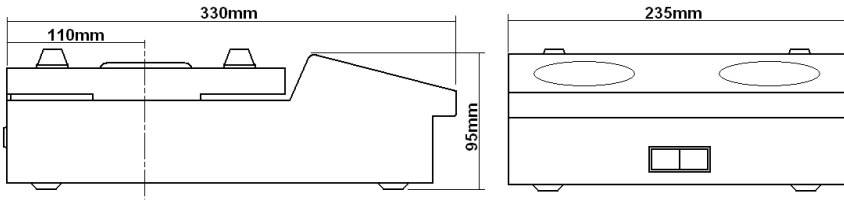

Weight 2.55kg

Dimensions & weight (unpacked) - Controller and dry block

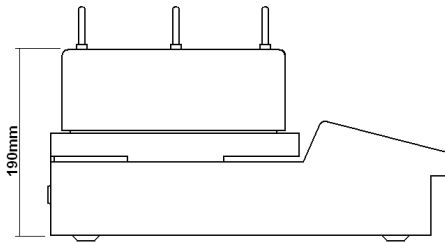

Weight 3.1kg

Dimensions & weight (unpacked) - Controller and dry block with reflux unit

Closed position

Open position

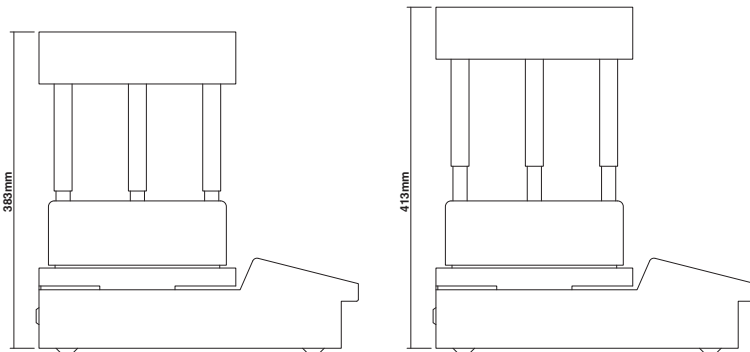

Weight 4.1kg

9. MAINTENANCE



DUE TO THE MASS OF THE CARTRIDGE, NEVER SHIP A UNIT WITH THE CARTRIDGE IN PLACE ON THE DIGI-MANTLE. ALWAYS PACK THE CARTRIDGE AND DIGI-MANTLE SEPARATELY BEFORE TRANSPORTATION.

9.1. General Information.



Unplug the unit from the mains voltage supply and allow it to cool before undertaking any maintenance tasks.



Maintenance should only be carried out under the direction of the Responsible Body, by a competent electrician. Failure to do so may result in damage to the product and in extreme cases be a danger to the end user.

With proper care in operation this equipment has been designed to give many years of reliable service. Contamination or general misuse will reduce the effective life of this product and may cause a hazard.

Maintenance for the unit should include:

- Periodic electrical safety testing (an annual test is recommended as the minimum requirement).
- Regular inspection for damage with particular attention to the mains lead and plug set.
- Routine cleaning of the equipment should be undertaken using a clean cloth.

DO NOT USE SOLVENTS FOR CLEANING ANY PART OF THIS EQUIPMENT.

9.2. Fuse Replacement.

The mains fuse holder is located at the rear of the unit. Refer to 'Fuse rating' in the Technical Specification section for correct fuse type and rating. Turn your unit off and remove it from the mains electricity supply.

1. Unscrew both fuse holder caps from the fuse housings
2. Remove the fuses. Inspect fuse for damage. Fit replacement fuses of suitable rating and value (Refer to Technical Specification section) and refit into fuse housing.

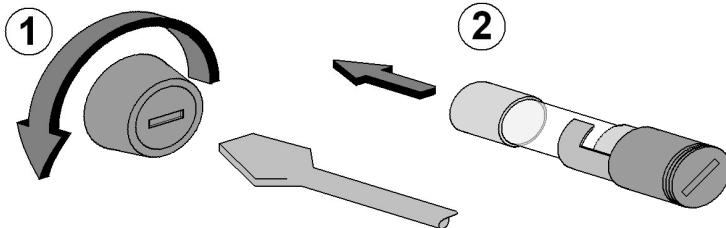

9.3. Decontamination.



If the equipment has been exposed to spillage or contamination, the responsible body is responsible for carrying out appropriate decontamination. If hazardous material has been spilt on or inside the equipment, decontamination should only be undertaken under the control of the responsible body with due recognition of possible hazards. Before using any cleaning or decontamination method, the responsible body should check with the manufacturer that the proposed method will not damage the equipment.

If the dry block cartridge comes into contact with liquids in cases of flask breakage or light spillage, the procedure is:

1. Disconnect the Omni Reaction Station from the electrical supply.
2. The dry block should be removed from the control unit when cool to touch.
3. Remove any broken glass or solids from the dry block.
4. Place the dry block in a low temperature oven at 60-80°C in order to evaporate the spilled fluid.



Only carry out oven drying procedure after ensuring that there is no low flash point in the substance present with respect to 60–80°C drying temperature.

Replace the dry block back into the control unit of the Omni Reaction Station.

Prior to further use, the responsible body shall check the electrical safety of the unit. Only if all safety requirements are met can the unit be used again. The above procedure is intended as a guide. Should spillage occur with a toxic or hazardous fluid then special precautions may be necessary.

Decontamination Certificate

Note: In the event of any part of the Omni Reaction Station becoming damaged, the damaged item(s) should be returned to the manufacturer for repair accompanied by a decontamination certificate. **Copies of the certificate are available from distributor/manufacturer.**

At the end of its life this product MUST be accompanied with a Decontamination Certificate.

10. SPARES AND ACCESSORIES

Spares

HH179(S)	Mains cord and moulded IEC plug and lead set cable (UK) 10A BS1362
HH180(S)	Mains cord and moulded IEC plug and lead set cable (Europe)
CRM6288	Mains cord and moulded IEC plug and lead set cable (USA)
OMCA	OMNI Station Controller (US/Canada)
OMCAX1	OMNI Station Controller (UK/EU)

Accessories

ATS10063	Temperature Probe
----------	-------------------

10 Way Dry Block Accessories

ATS10114	Cooling Plug, for 10 way OMNI Dry Block
AZS4235	Stirrer bars, 12x4.5mm, Rare Earth x10
ATS10055	Small volume test tubes 24-16mm taper (3ml) x10
ATS10056	Reducing sleeves for ATS10055x10
ATS10209	Small volume test tubes 24-11mm taper (1ml) x10
ATS10101	Reducing sleeves for ATS10209 x10
ATS10134	Reaction vessels 24mmODx150mm, 22mm thread, Crystallisation, small volume x10
ATS10135	Reaction vessels 24mmODx150mm, 22mm thread, Crystallisation, larger volume, x10
OSD1025	10x25 Dry Block (500W) (UK/EU)
OSD1025X1	10x25 Dry Block (500W) (US/Canada)
ATS10075	Glass vessels, 24x150mm, 22SVL x10
AZS4206	Stirrer bars, Oval, 10x6mm, Rare Earth x10
ATS10115	Reflux/Inerting Head 10 x 25mm
ATS10377	Inerting cap + probe hole x10

Please contact your local sales specialist or email cpspares@antylia.com to enquire about available spares.

Please visit www.coleparmer.com for a full list of available accessories.

11. CUSTOMER AND TECHNICAL SUPPORT

For help and support in using this product, please contact Customer Services at the following address:

Antylia Scientific Ltd.
Beacon Road,
Stone,
Staffordshire,
ST15 0SA,
United Kingdom
Tel: +44 (0)1785 812121

Service: cpsservice@antylia.com
General enquiries: cpinfo@antylia.com
Order enquiries: cpsales@antylia.com
Technical support: cptechsupport@antylia.com

www.coleparmer.com

APPENDIX 'A' STEM Protocol Commands

Stem address and serial port

The unit address of the Omni-station is 50. It cannot be changed.

The serial port operates at 9600 baud, eight data bits, no parity, one stop bit ("9600, N, 8, 1"). There is no hardware or software data handshake. DCD, DSR and CTS are asserted, DTR and RTS are not connected.

The serial port is wired as DCE (the Omni-station receives on pin 3 and transmits on pin 2).

Temperature control

TT - target temperature:

- Decimal values permitted, but are truncated to integer.
- Out-of-range values are rejected as bad commands.
- If a temperature probe is fitted, the system will attempt to make the probe reach the target temperature.
- If no temperature probe is fitted but the block has an internal temperature sensor, the system will attempt to make the block reach the target temperature.
- If neither probe nor internal thermometer are present, the value in the target temperature command will be interpreted as a duty cycle command.
- If a ramp-rate is set, a change in target temperature during heating/cooling restarts the ramp from the current temperature.

Example >50 TT55 #0000[cr] will set the temperature to 55°C.

TE - enable thermal control:

- 1 = enable, 0 = disable.

Example >50 TE1 #0000[cr] will set the temperature control to active.

TR - temperature ramp rate:

- Decimal values permitted, but are truncated to integer.
- Out-of-range values are rejected as bad commands.
- Units are degrees C per minute.
- A value of 0 turns off ramp-rate control (i.e. crash heat/cool).
- Ramp is applied from the current temperature, not the present target temperature (e.g. if a target of 100 had been set, but it had not yet been achieved and was at 80, and a new target of 120 is commanded, the temperature will be set to ramp from 80 to 120 and not from 100 to 120).
- A change in ramp rate during heating/cooling restarts the ramp from the current temperature

Example >50 TR3 #0000[cr] will set the temperature ramp rate to 3°C per min.

Stirring control

SS - stir speed:

- Decimal values permitted, but are truncated to integer.
- Out-of-range values are rejected as bad commands.

Example >50 SS500 #0000[cr] will set the stir speed to 500RPM.

SE - stir enable:

- 1 = enable, 0 = disable

Example >50 SE1 #0000[cr] will set the stir control to active.

Machine control

LK - Local keypad enable:

- 0 will prevent the local keypad from doing anything (other than beep), and permits use of DT (display text) command.
- It is advised that the DT command is used to inform the user that the equipment is locked and being controlled via PC.
- 1 will allow control from the keypad.
- The LCD display is cleared of DT on receipt of the LK1 command.

Example >50 LK0 #0000[cr] will disable the keypad.

DT - Display Text (new Stem Protocol command):

- Display is two lines of 16 characters per line.
- String sent in DT command is up to 32 characters which are displayed starting at top left, and wrapping (if more than 16 characters) from top line to bottom line.
- Display is not cleared; new string overwrites any existing message. To clear display either pad string with spaces or issue LK0 command.
- Text is sent as single string of printable ASCII characters surrounded by quote characters. (ASCII 0x22) e.g. >50 DT" LOCKED FROM PC" #0000[cr].
- Only valid if the keypad is disabled by LK0 command, otherwise it returns an "unrecognised command" response.

RF - reset error flags:

- Requires an argument (e.g. RF1), but the argument is ignored.
- The command will clear the error condition flag, but if/when the error persists/recurs, the flag will immediately be re-asserted.

Query commands

QC - request commanded variables:

- Returns TT, TR, TE, SS, SE, LK.

Example >50 QC #0000[cr].

QM - request measured variables:

- Returns SM, TM, TX, XZ.
- TM returns 999 if no internal thermometer is detected in the module.
- TX returns 999 if no temperature probe is detected.
- XZ is sent only if an error condition exists. Its argument is a string containing the same text as is shown on the LCD display in normal use.

Example >50 QM #0000[cr].

QF - request fixed values:

- Returns FA, FB, FC, NP, SH, SL, TH, TL, RH, RL, UT.
- FA is system firmware version.
- FB is module ID number as a string "IDn".
- TH and FB require one successful Stem command after power-up before they will return valid values. This is due to the display of module type presented to the user during normal use.

Example >50 QF #0000[cr].

 This product meets the applicable CE Directives and UKCA Legislation for radio frequency interference and may be expected not to interfere with, or be affected by, other equipment with similar qualifications. We cannot be sure that other equipment used in its vicinity will meet these standards and so we cannot guarantee

that interference will not occur in practise. Where there is a possibility that injury, damage or loss might occur if equipment malfunctions due to radio frequency interference, or for general advise before use, contact the manufacturer.

Declaration of Conformity is available to view online at www.coleparmer.com

EU Representative address

Antylia Scientific GmbH
Futtererstraße 16
97877 Wertheim
Deutschland
Tel: +49 9377 9203-0
Email: sales@coleparmer.de

UK Representative address

Antylia Scientific
9 Orion Court
Ambuscade Road
Colmworth Business Park
St. Neots
PE19 8YX
United Kingdom
Tel: +44 (0) 1480 277339
Email: enquiries@antylia.com

Ordering Information

Order No.	Series	Model	Legacy SKU
36630-01	RS-200	RS-200D	OS1025
36630-02	RS-200	RS-200D-115	OS1025X1

Warranty Registration



UK

T: +44 (0) 1480 272279
E: uk.sales@antylia.com
W: coleparmer.co.uk

Germany

T: +49 (0) 9377 92030
E: de.sales@antylia.com
W: coleparmer.de

France

T: +33 (0) 1486 37800
E: fr.sales@antylia.com
W: coleparmer.fr

Italy

T: +39 (0) 284349215
E: it.sales@antylia.com
W: coleparmer.it

India

T: +9122 61394444
E: info@coleparmer.in
W: coleparmer.in

China

T: +1 847 549 7600
E: sales@antylia.com
W: coleparmer.com

USA

T: +1 847 549 7600
E: sales@antylia.com
W: coleparmer.com

Canada

T: +514 355 6100
E: info@antylia.ca
W: coleparmer.ca

Other

T: +1 847 549 7600

Cole-Parmer[®]
essentials

Antylia Scientific Ltd.

Beacon Road,
Stone,
Staffordshire,
ST15 0SA,
United Kingdom

