

Precision Nitrogen (All Models)

User Manual

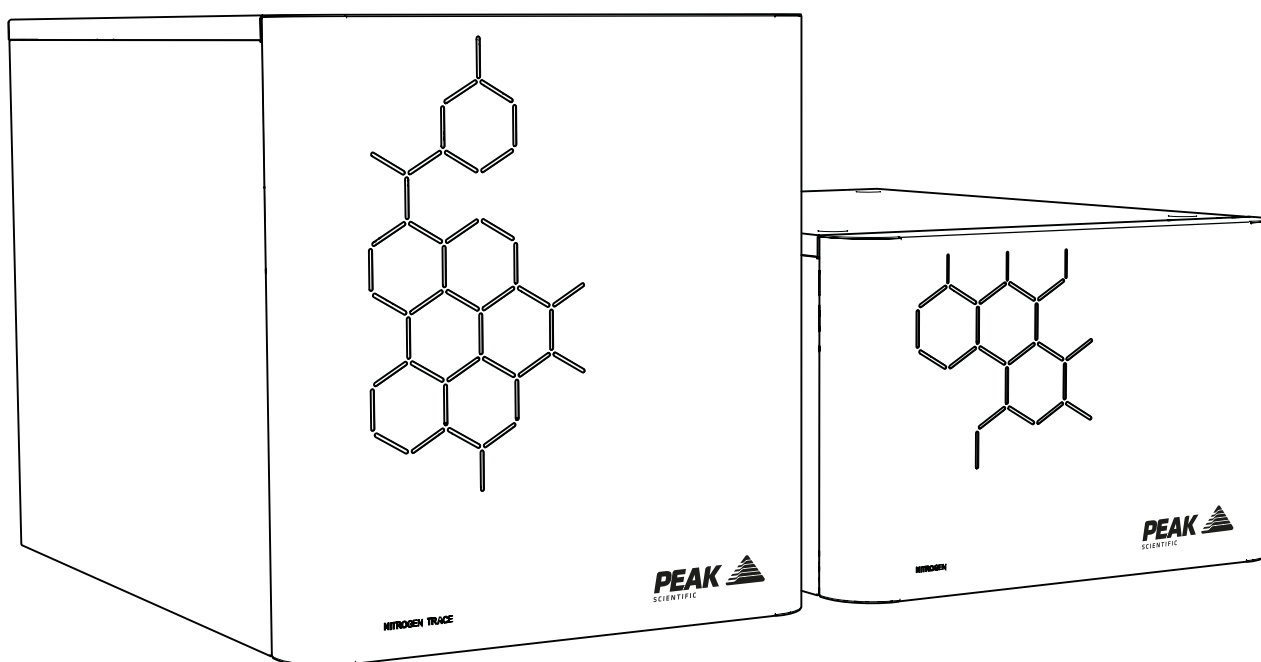

Contents

Change History	3
How to use this Manual	3
Introduction	4
Warranties and Liabilities	5
Safety Notices	6
Symbols	6
Safety Notice to Users	6
Declaration of Conformity	7
Environmental Declaration	8
Technical Specification	9
Unpacking	11
Fittings Kit Contents	12
Unpacking Instructions	12
Installation	13
Generator Environment	13
Generator Overview	14
Nitrogen General Dimensions	14
Nitrogen Trace General Dimensions	15
Nitrogen Rear Connections	16
Nitrogen Trace Rear Connections	17
Electrical Connection	18
Air Purity	19
Class 1 Particulate	19
Class 4 Water	19
Class 1 Oil	19
Start-Up Sequence	20
On Demand Gas	20
Unusual Operation	20
Connecting to the application	21
Tubing Lengths	21
Service Requirements	22
Service Schedule	22
Peak Protected	23
Cleaning	24
Troubleshooting	25

Change History

Rev	Comment	Name	Date
1	Release	Liam Couttie	14/12/2016
2	Technical Specification Update	Liam Couttie	08/02/2016
3	Nitrogen Headspace Added	Liam Couttie	06/09/2016
4	Product Overview Correction	Liam Couttie	21/12/2017
5	Cleaning Information Update	Liam Couttie	28/02/2018
6	Declarations Update	Liam Couttie	24/04/2018
7	Declarations Update	Cleo Denholm	31/11/2021

How to use this Manual

This manual is intended for end users and has been written as a reference document where you can skip to the relevant information.

Users can refer to the contents page to find the relevant information.

Please review each of the following sections carefully.

Thank you for selecting Peak Scientific to meet your gas generation needs, and should you require any further assistance or support please do not hesitate to contact Peak Scientific or the Peak Partner from which you purchased your generator.

Introduction

Precision is a modular system with differing flow rates that allows you to add multiple generators as your gas and analysis demands change. The Precision Series will keep your gas flowing with consummate accuracy and reliability, whatever your needs, while fitting neatly into any lab space.

The Precision Nitrogen, Headspace and Nitrogen Trace Generators provide a constant and consistent source of Nitrogen for detector make-up gas for GC applications, as well as headspace vial pressurization, purge and trap, tube conditioning for thermal desorption and sample blow down. In addition to these applications, the Precision Nitrogen Trace model can be used for carrier gas in GC applications as it also removes hydrocarbons by means of catalytic oxidation.

Other features include:

- Generates Nitrogen on demand from compressed air.
- Regenerative PSA Carbon Molecular Sieve to ensure Oxygen and Moisture removal.
- Minimum maintenance with only a filter change per annum.
- Small and Stackable.

With the Precision Nitrogen based on proven technology, it removes moisture and oxygen to leave Ultra High Purity Nitrogen. The Nitrogen Trace further removes Hydrocarbons (as Methane) to <0.05ppm.

To ensure these generator models meet our high expectations with regards to reliability and performance, we have tested them extensively at our manufacturing plant and with end users around the world to ensure reliability and longevity of the system.

Warranties and Liabilities



1. The Company warrants that it has title to the Goods.
2. Subject to the provisions of this clause the Company warrants that the Goods shall comply in all material respects with any specification referred to in the Order Confirmation (as the same may be amended) and shall, subject thereto, be free from defects in material and workmanship for the lesser of a period of twelve months from the date of delivery or thirteen months from the date of dispatch from the factory.
3. Save as provided in this clause and except where the Goods are sold to a person dealing as a consumer (within the meaning of the Unfair Contract Terms Act 1977) all warranties, conditions or other terms implied by statute or common law are hereby expressly excluded save to the extent they may not be lawfully excluded. When the Goods are sold to a consumer within the meaning of the Unfair Contract Terms Act 1977 their statutory rights are not affected by the provisions of this clause.
4. In the event of the Customer making a claim in respect of any defect in terms of clause 2 hereof the Customer must.
 1. Reasonably satisfy the Company that the Goods have been properly installed, commissioned, stored, serviced and used and without prejudice to the generality of the foregoing that any defect is not the direct or indirect result of lack of repair and/or servicing, incorrect repair and/or servicing, use of wrong materials and/or incorrect spare parts
 2. Allow the company to inspect the Goods and/or any installation and any relevant packaging as and when reasonably required by the Company.
5. Subject to the Company being notified of any defect as is referred to in sub-clause 2 hereof within a reasonable time of it becoming apparent and subject always to the terms of sub-clause 4 hereof, the Company shall, in its option, replace or repair the defective Goods or refund a proportionate part of the Price. The Company shall have no further liability to the Customer (save as mentioned in sub-clause 6 hereof).
6. The Company shall be liable to indemnify the Customer in respect of any claim for death or personal injury to any person in so far as such is attributable to the negligence or breach of duty of the Company or any failure by the Company to comply with the provisions of sub-clause 2 hereof.
7. Save as provided in sub-clause 2 hereof the Company shall not be liable in respect of any claim by the Customer for costs, damages, loss or expenses (whether direct, indirect, consequential or otherwise) or indemnity in any respect howsoever arising including, but not by way of limitation, liability arising in negligence (other than pursuant to clause 6 above) that may be suffered by the Customer or any third party.

Safety Notices

Peak Scientific Instruments cannot anticipate every possible circumstance which may represent a potential hazard. The warnings detailed within this manual refer to the most likely potential hazards, but by definition cannot be all inclusive. If the user employs an operating procedure, item of equipment or a method of working which is not specifically recommended by Peak Scientific, the user must ensure that the equipment will not be damaged or become hazardous to persons or property.

Symbols

This manual uses the following symbols to highlight specific areas important to the safe and proper use of the generator.

 WARNING	A WARNING notice denotes a hazard. It calls attention to an operating procedure, process or similar, which if not correctly performed or adhered to, could cause personal injury or in the worst case death. Do not proceed beyond a WARNING notice until the indicated conditions are fully understood or met.
 CAUTION	A CAUTION notice denotes a hazard. It calls attention to an operating procedure, process or similar, which if not correctly performed or adhered to, could cause damage to the generator or the application. Do not proceed beyond a CAUTION notice until the indicated conditions are fully understood or met.
	Caution, risk of electric shock. Ensure power to the generator has been removed before proceeding.

Safety Notice to Users



These instructions must be read thoroughly and understood before installation and operation of your Peak Generator. Use of the generator in a manner not specified by Peak Scientific MAY impair the SAFETY provided by the equipment.



When handling, operating or carrying out any maintenance, personnel must employ safe engineering practices and observe all relevant local health and safety requirements and regulations. The attention of UK users is drawn to the Health and Safety at Work Act 1974, and the Institute of Electrical Engineers regulations.



If the equipment is used in a manner not specified by the manufacturer, the protection provided by the equipment maybe impaired.

EU Declaration of Conformity

We Peak Scientific Instruments Ltd.
Of Fountain Crescent, Inchinnan, Renfrewshire, PA4 9RE

Hereby declare that, this declaration of conformity is issued under the sole responsibility of the manufacturer.

Equipment Type: Nitrogen Generator
Model Designator: Precision Nitrogen 250cc, 600cc, 1000cc, Headspace
Precision Nitrogen Trace 250cc, 600cc, 1000cc

To which this declaration relates, is in conformity with the following applicable EU Directives, harmonized standards, and other normative requirements.

- **Low Voltage Directive 2014/35/EU**
EN 61010-1: 2010 Safety Requirements for Electrical Equipment for Measurement, Control and Laboratory Use.
- **Electromagnetic Compatibility Directive 2014/30/EU**
EN 61326-1: 2013 Electrical Equipment for Measurement, Control and Laboratory Use - EMC Requirements. (Class A)
- **Restriction on the use of certain hazardous substances in electronic equipment (RoHS) Directive 2011/65/EU as amended by EU 2015/863.**
- **FCC 47 CFR Part 15 class A**
Unintentional radiators; Conducted and Radiated emissions limits.

Signed for and on behalf of Peak Scientific by

Signed: 

Name: Fraser Dunn

Position: Design Engineering Manager
Peak Scientific Instruments Ltd,
Inchinnan, Renfrew, Scotland, PA4 9RE, UK.

Date: 30th November 2021



UK Declaration of Conformity

We Peak Scientific Instruments Ltd.
Of Fountain Crescent, Inchinnan, Renfrewshire, PA4 9RE

Hereby declare that, this declaration of conformity is issued under the sole responsibility of the manufacturer.

Equipment Type: Nitrogen Generator
Model Designator: Precision Nitrogen 250cc, 600cc, 1000cc, Headspace
Precision Nitrogen Trace 250cc, 600cc, 1000cc

To which this declaration relates, is in conformity with the following applicable UK Statutory Instruments, Standards and other normative requirements.

- **The Electrical Equipment (Safety) Regulations 2016 (SI 2016 / 1101) as amended.**
BS61010-1:2010 Safety Requirements for Electrical Equipment for Measurement Control and Laboratory Use.
- **The Electromagnetic Compatibility Regulations 2016 (SI 2016 / 1091) as amended.**
BS61326-1:2013 Electrical Equipment for Measurement , Control and Laboratory Use - EMC Requirements.
- **The Restriction of the Use of Certain Hazardous Substances in Electrical and Electronic Equipment Regulations 2012 (SI 2012 / 3032) as amended.**

Signed for and on behalf of Peak Scientific by

Signed: 

Name: Fraser Dunn

Position: Design Engineering Manager
Peak Scientific Instruments Ltd,
Inchinnan, Renfrew, Scotland, PA4 9RE, UK.

Date: 30th November 2021



WEEE Compliance Statement

The Waste Electrical and Electronic Equipment (WEEE) Regulations SI 2013 No 3113 and or the Waste Electrical and Electronic Equipment (WEEE) Directive 2012/19/EU apply to all electrical and electronic equipment placed on the market in the UK and EU covered by the scope of regulations which can be found in the Government Guidance Notes (PDF) produced by the Department for Business Innovation and skills for the UK and here for Europe.

All PEAK products that are subject to the WEEE directive are compliant with the WEEE marking requirement. Such products are marked with the “crossed-out wheellie bin” symbol (shown below) in accordance with European standard EN50419. All old electrical equipment can be recycled. Please do not dispose of any electrical equipment (including those marked with this symbol) in general rubbish bins. Please contact your dealer or distributor for clarity.



CSA Compliance Statement

CSA Group (Canadian Standards Authority) is a Nationally Recognised Testing Laboratory (NRTL), headquartered in Toronto Canada.

They are authorised to evaluate product to both their own and Underwriters Laboratory (UL) standards and certify the product to be in compliance to the relevant standards.

Peak products are certified to the current in force revision of the following standards in order to cover both Canadian and United States requirements for “Safety Requirements for Electrical Equipment for Measurement, Control and Laboratory use, Part 1: general Requirements”.

Canada: CAN/CSA C22.2 No 61010-1-12

United States: UL 61010-1

As a result the products covered by this statement are certified and listed by CSA accordingly and are entitled to carry the CSA mark with both Canadian and United States subscripts , as shown below on the product rating label.



Technical Specification

Precision Nitrogen

Environment

	250cc	600cc	1000cc
Minimum Operating Ambient Temperature	5°C (41°F)		
Maximum Operating Ambient Temperature	35°C (95°F)		
Maximum Altitude	2000 m		
Maximum Relative Humidity	70% Non-Condensing		
Minimum Storage Temperature*	-20°C (-4°F)		
Maximum Storage Temperature*	60°C (140°F)		

Inlet Conditions

Inlet Air Pressure Min-Max	6.9-8.3 bar (100-120 psi)
Minimum Air Inlet Flow	35 l/min
Minimum Air Inlet Quality	ISO 8573-1:2010 Class[1.4.1]
Particles	<0.01µm

Generator Outlets

Maximum Gas Output Pressure	5.5 bar (80 psi)		
Maximum Outlet Flow Rate	250cc	600cc	1000cc
Start-up time	1.5 Hours		
Particles	<0.01µm		
Phthalates	NONE		
Suspended Liquids	NONE		
Gas Outlets	1 x ¼" BSPP		

For optimum performance from your Precision Nitrogen generator, the inlet gas supply pressure should be 30PSI greater than the required output pressure.

Electrical Requirements

Voltage	100-240v
Frequency	50/60 Hz
Current	0.4-0.2A
Input Connection	C14 Plug
Power Cord (Supplied)	C13 Socket to Local Connection
Pollution Degree	2
Insulation Category	II

General

Dimensions cm (inches) WxDxH	38.0 (14.9) x 54.0 (21.2) x 25.6 (10.0)	
Generator Weight Kg (lbs)	21 (46.2)	26 (57.3)
Shipping Weight Kg (lbs)	24 (53)	29 (64)

Technical Specification

Precision Nitrogen Headspace

Environment

Minimum Operating Ambient Temperature	5°C (41°F)
Maximum Operating Ambient Temperature	35°C (95°F)
Maximum Altitude	2000 m
Maximum Relative Humidity	70% Non-Condensing
Minimum Storage Temperature*	-20°C (-4°F)
Maximum Storage Temperature*	60°C (140°F)

Inlet Conditions

Inlet Air Pressure Min-Max	8.3-8.6 bar (120-125 psi)
Minimum Air Inlet Flow	18 l/min
Minimum Air Inlet Quality	ISO 8573-1:2010 Class[1.4.1]
Particles	<0.01µm

Generator Outlets

Maximum Gas Output Pressure	6.9 bar (100 psi)
Maximum Outlet Flow Rate	250cc
Start-up time	3 - 3.5 Hours
Particles	<0.01µm
Phthalates	NONE
Suspended Liquids	NONE
Gas Outlets	1 x ¼" BSP

For optimum performance from your Precision Nitrogen generator, the inlet gas supply pressure should be 30PSI greater than the required output pressure.

Though the Precision Headspace Generator delivers nitrogen at a purity suitable for most non- trace applications, we would recommend the installation of oxygen and hydrocarbon traps for analysis at lower detection limits (<1000ppm).

Electrical Requirements

Voltage	110-230v ±10%
Frequency	50/60 Hz
Current	0.37 -0.17 A
Input Connection	C14 Plug
Power Cord (Supplied)	C13 Socket to Local Connection
Pollution Degree	2
Insulation Category	II

General

Dimensions cm (inches) WxDxH	38.0 (14.9) x 54.0 (21.2) x 25.6 (10.0)
Generator Weight Kg (lbs)	21 (46.2)
Shipping Weight Kg (lbs)	24 (53)

Technical Specification

Precision Nitrogen Trace

Environment

	250cc	600cc	1000cc
Minimum Operating Ambient Temperature	5°C (41°F)		
Maximum Operating Ambient Temperature	35°C (95°F)		
Maximum Altitude	2000 m		
Maximum Relative Humidity	70% Non-Condensing		
Minimum Storage Temperature*	-20°C (-4°F)		
Maximum Storage Temperature*	60°C (140°F)		

Inlet Conditions

Inlet Air Pressure Min-Max	8.3-10 bar (120-145 psi)		
Minimum Air Inlet Flow	18 l/min	22 l/min	
Minimum Air Inlet Quality	ISO 8573-1:2010 Class[1.4.1]		
Particles	<0.01µm		

Generator Outlets

Maximum Gas Output Pressure	5.5 bar (80 psi)		
Maximum Outlet Flow Rate	250cc	600cc	1000cc
Start-up time	1.5 Hours		
Particles	<0.01µm		
Phthalates	NONE		
Suspended Liquids	NONE		
Gas Outlets	1 x ¼" BSPP		

Electrical Requirements

Voltage	115 VAC ±10%	230VAC ±10%	
Frequency	60 Hz	50 Hz	
Current	4.4A	2.1A	
Input Connection	C14 Plug		
Power Cord (Supplied)	C13 Socket to Local Connection		
Pollution Degree	2		
Insulation Category	II		

General

Dimensions cm (inches) WxDxH	38.0 (14.9) x 54.0 (21.2) x 40.6 (15.8)		
Generator Weight Kg (lbs)	38 (83.6)	38 (83.6)	36(79.2)
Shipping Weight Kg (lbs)	42 (92.4)	42 (92.4)	40(88)

Unpacking

Although Peak Scientific takes every precaution with safe transit and packaging, it is advisable to fully inspect the unit for any sign of transit damage.

Check 'SHOCKWATCH' and 'TIP-N-TELL' labels for signs of rough handling prior to unpacking.

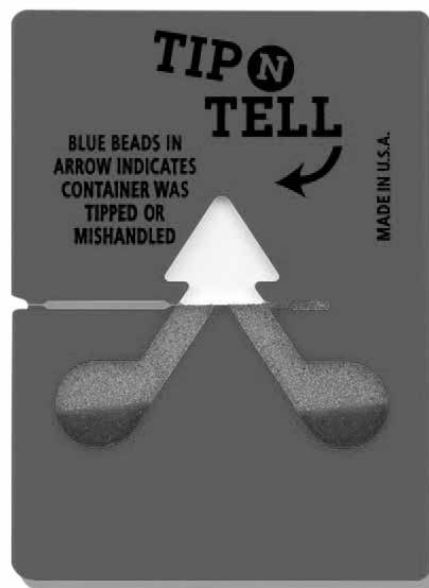

Any damage should be reported immediately to the carrier and Peak Scientific or the Peak Partner from where the unit was purchased.

Follow the unpacking instructions posted on the side of the crate. It will require two people to remove the unit from the shipping crate and to manoeuvre the generator onto the bench.

Please save the product packaging for storage or future shipment of the generator.

Note: Included with the generator is a "Fittings Kit" containing mains power leads for UK, EU & US and also all the required fittings and warranty registration card. Be careful not to discard these with the packaging.

Fittings Kit Contents

Supplied in the Fittings Kit are all the fittings required to connect the generator to the application. The contents of the Fittings Kit are as follows:

- | | |
|------------------------------|------|
| 1. Teflon Tubing | x 3m |
| 2. ¼" Compression Fitting | x 1 |
| 3. 1/8" Compression Fitting | x 1 |
| 4. UK Mains Power Cable | x 1 |
| 5. EU Mains Power Cable | x 1 |
| 6. US Mains Power Cable 110v | x 1 |
| 7. US Mains Power Cable 230v | x 1 |

All of the generators output ports are located on the output panel at the rear of the unit.

Unpacking Instructions

The unit weight constitutes a two person lift and as such, safe lifting practices should be employed; do not attempt to lift on your own, as you will significantly increase the chance of injury & damage to yourself and others around you.

1. Remove the screws encircled in red around the bottom of the crate lid and lift upwards.
2. Next, with someone on either side of the unit, position your hands underneath the unit ready to lift.
3. Ensuring your knees are bent and your back is straight, lift the unit to the desired location.

Installation

Generator Environment

The generator is designed for indoor use only. Storing of corrosive substances near the generator or compressed air supply is not recommended. Saline salt solution spillages around the generator or their compressed air supply should be cleaned up immediately. It should be installed adjacent to the application(s) it is supplying. If this is not convenient then the unit can be sited elsewhere, however, consideration should be made of the lengths of pipe runs as pressure drops can result from extended runs of pipe.

Performance of the generator (like all sophisticated equipment) is affected by ambient conditions. Note should also be taken to the proximity of Air Conditioning outlets. These can sometimes give rise to “pockets” of air with high relative humidity. Operation of the unit within such a pocket could adversely affect its performance. Consideration should also be given to the air flow around the unit. It is recommended that an air gap of 75mm (3”) should be maintained down both sides and at the rear of the unit. Please refer to the drawing below for the general dimensions of the unit.

Minimum Operating Ambient Temperature: 5 °C (41 °F)

Maximum Operating Ambient Temperature: 35 °C (95 °F)

Generator Overview

Nitrogen General Dimensions

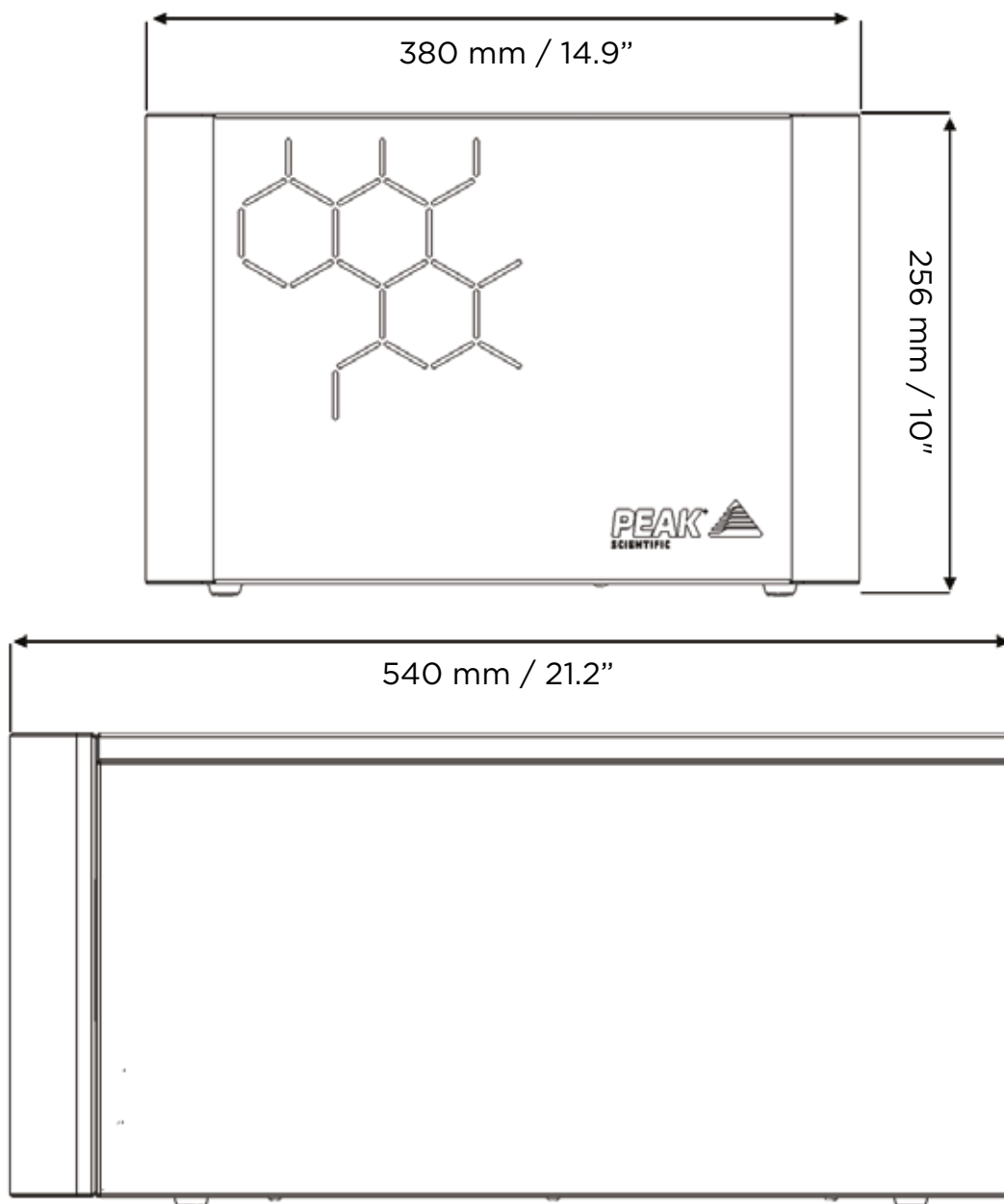

The generator must always be placed on a flat, level surface. Failure to do so will affect the performance of the generator.

Nitrogen Trace General Dimensions

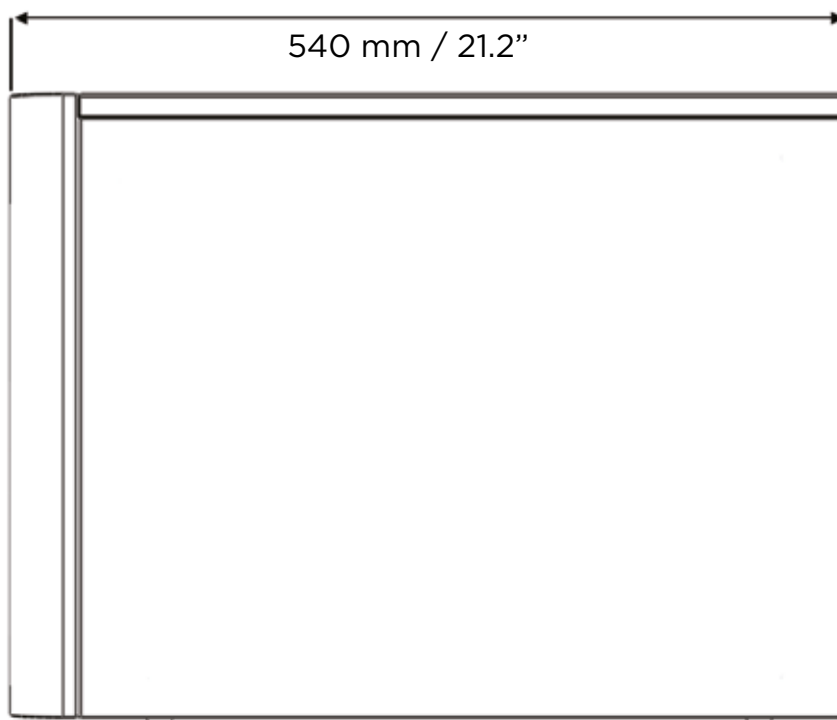
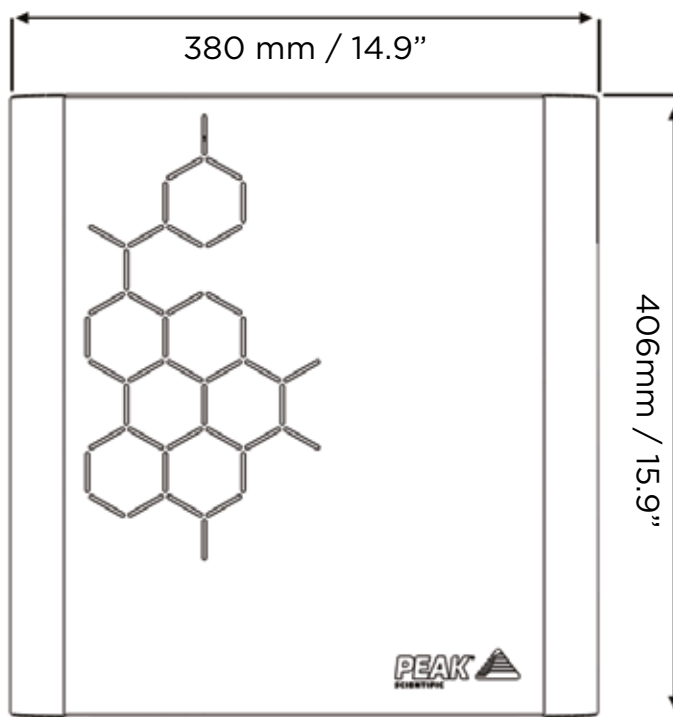

The generator must always be placed on a flat, level surface. Failure to do so will affect the performance of the generator.

Nitrogen/Headspace Rear Connections

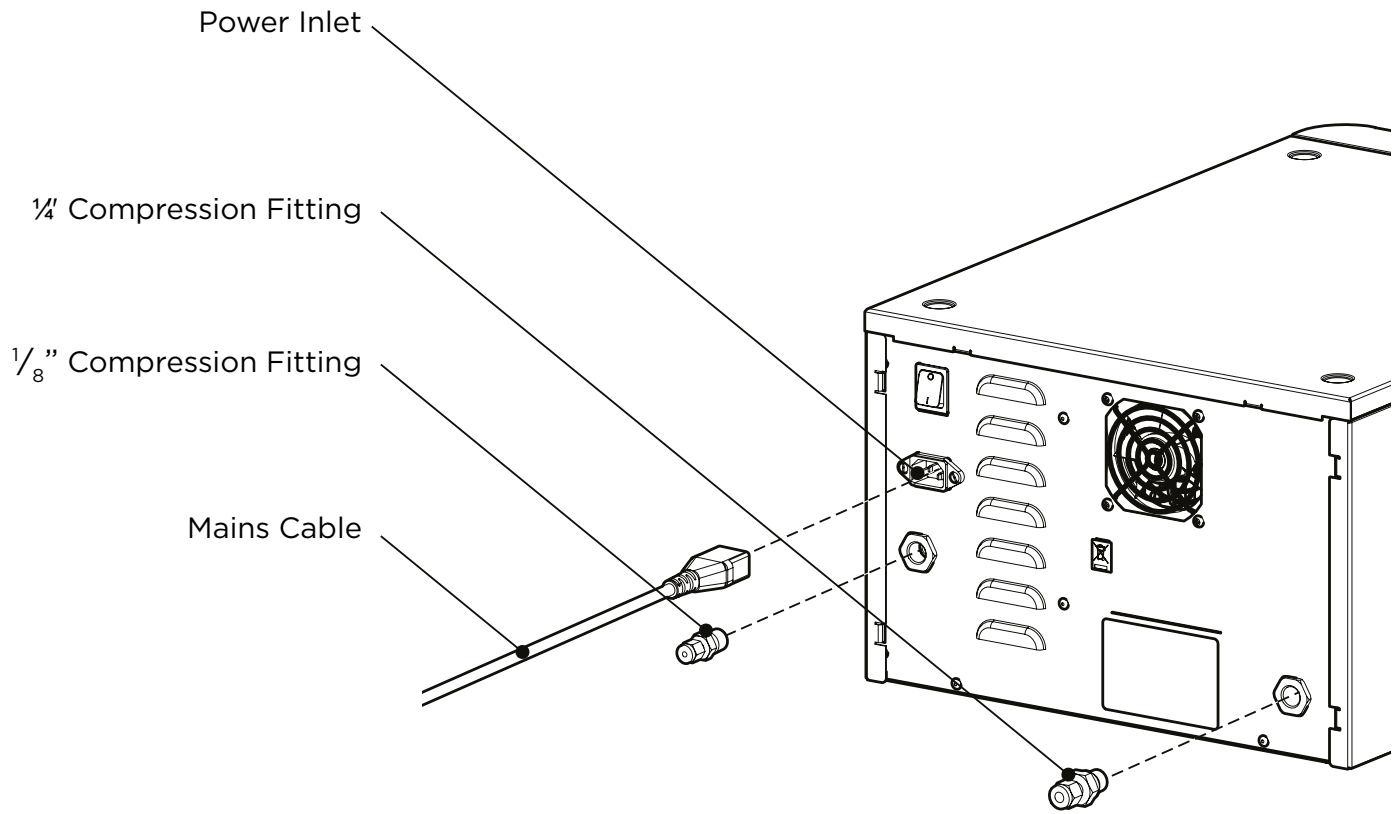

Nitrogen Trace Rear Connections

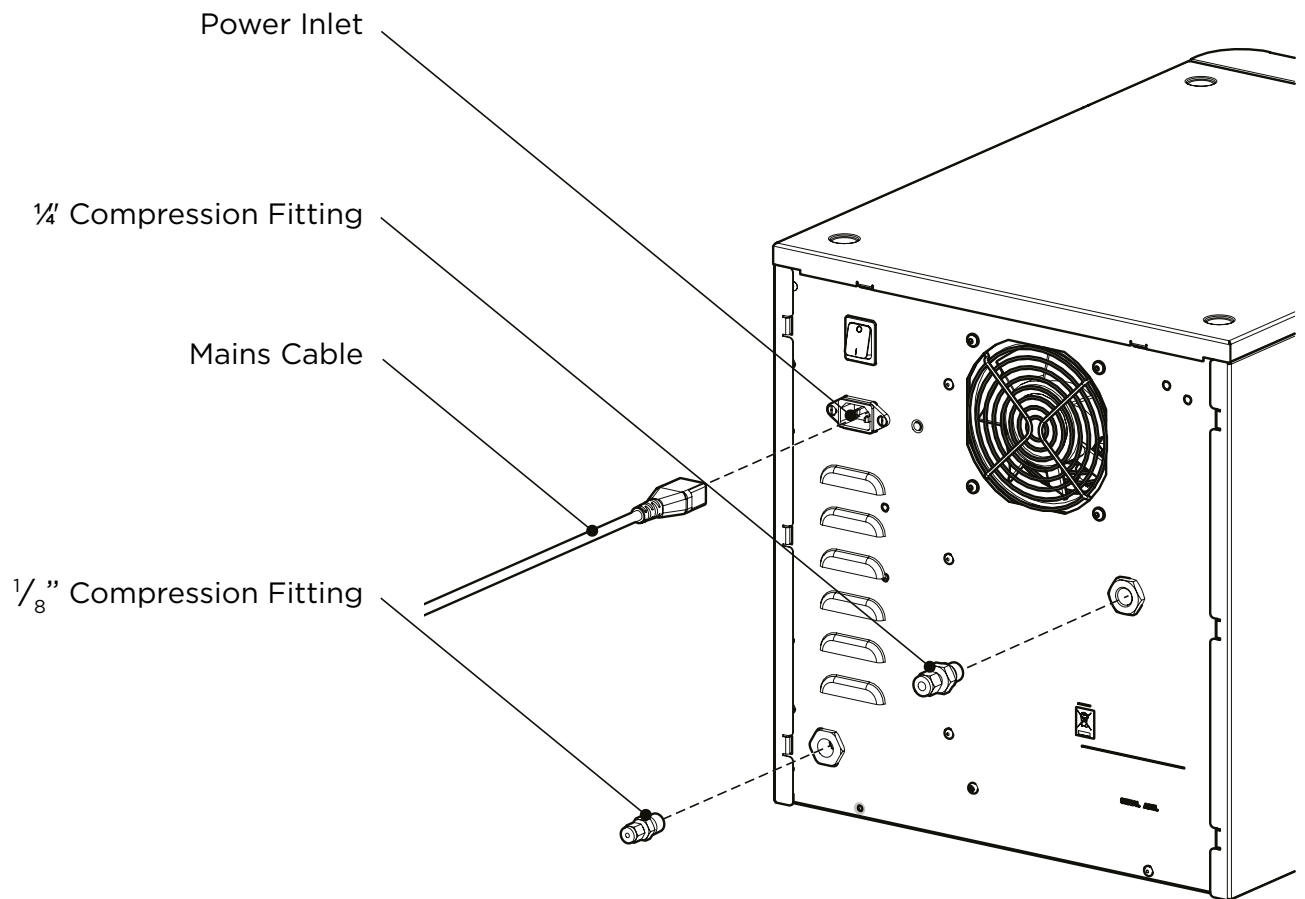

Electrical Connection

Connect the generator to an appropriate 110 or 230 volt single-phase supply, refer to the generator serial plate for input specification and ensure your supply matches the requirements.

If the appropriate power cord is not supplied; a new plug, rated to at least 12 amps, can be fitted by a qualified electrician.



This unit is classified as SAFETY CLASS 1. THIS UNIT MUST BE EARTHED. Before connecting the unit to the mains supply, please check the information on the serial plate. The mains supply must be of the stated AC voltage and frequency.

EARTH/GROUND (E):-	Green & Yellow	or	Green
LIVE (L):-	Brown	or	Black
Neutral (N):-	Blue	or	White

Electrical requirements are 110 or 230VAC nominal +/- 10% depending on chosen model. However, running continuously at voltages outwith this is not recommended. Extended periods at extremes can have a detrimental effect on the operation and life of the generator.



If the equipment is used in a manner not specified by the manufacturer, the protection provided by the equipment maybe impaired.

Air Purity

The Precision Nitrogen Series generator should be connected to an air supply that, as a minimum, meets ISO8753-1:2010 Class 1.4.1

Class 1 Particulate

In each cubic metre of compressed air, the particulate count should not exceed 20,000 particles in the 0.1 - 0.5 micron size range, 400 particles in the 0.5 - 1 micron range and 10 particles in the 1 - 5 micron size range.

Class 4 Water

A pressure dew point (PDP) of +3°C or better is required and no liquid water is allowed.

Class 1 Oil

In each cubic metre of compressed air, not more than 0.01mg of oil is allowed. This is a total level for liquid oil, oil aerosol and oil vapour.

Start-Up Sequence

Switch the generator on using the power switch on the rear panel of the unit. Please note: Air will only flow through the generator when the power is switched on. The LED's on the front panel will illuminate **YELLOW** for the start-up period.

YELLOW for 90 Minutes

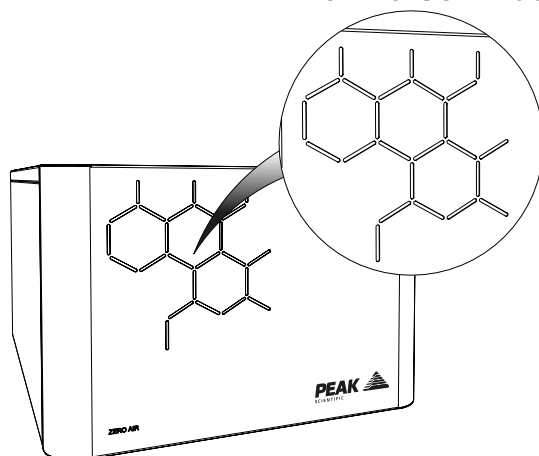

The generator will purge impurities from its internal storage tank until Oxygen content is less than 5PPM, approximately 1.5 hours (3-3.5 hours for Headspace) of uninterrupted operation. On completion, the Fascia will illuminate **GREEN** or **BLUE (70-**** Part Numbers Only)** and the generator is now ready to be connected to the application.

GREEN / BLUE

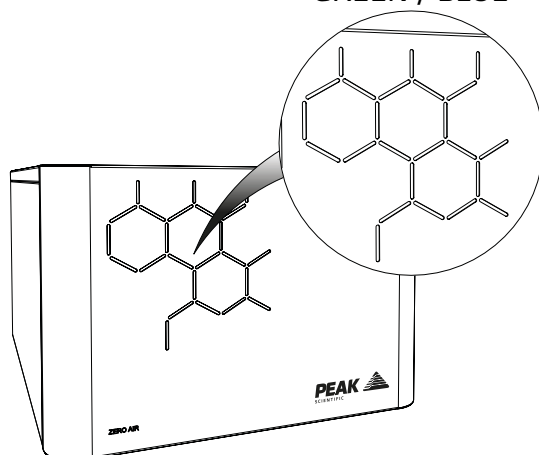

On Demand Gas

The generator will produce nitrogen on demand. If the application is operating and requires a gas flow, the system it is connected to will supply this to suit the requirements of the application. If the application requirement for gas stops, the system will also stop, once it has reached its upper set limit in the internal storage tanks. If the demand from the application starts again, the system will detect the demand for gas and will automatically start again to suit the demand.

Unusual Operation

If at any time the generator begins to emit excessive noise or vibration, then it should be switched off and you should contact Peak Scientific or the Peak Partner from which the generator has been purchased.

Connecting to the application

Once the initial purge run of 1.5 hours (3-3.5 hours for Headspace) has completed the generator is now ready to be connected to the application(s).



The pressure in the internal storage tanks must be allowed to dissipate before connecting the generator to the application(s)

Attach the 1/4" compression fitting to the outlet of the generator. Using the 1/4" tubing supplied, connect the outlet of the generator to the inlet on the application.

If you require more tubing than is supplied please refer to the Tubing Lengths section.



Once the tubing is connected to the application, please ensure that it is thoroughly checked for being leak-tight. Even the slightest leak in the gas supply between the generator and the application can lead to a reduction in efficiency.

Tubing Lengths



The diameter of the tubing which will be connected to the gas outlet is important and is determined by the length of tubing required. Failure to follow these recommendations could lead to an excessive pressure drop between the generator and its application.

- < 10 meters: Use 1/4"/3/16" (1/4" O/D, 3/16" I/D) P.T.F.E. tubing.
- > 10 - 40 meters: Use 3/8"/5/16" (3/8" O/D, 5/16" I/D). Tubing and fittings not supplied in the fittings kit.
- > 40 metres: Please contact Peak Scientific with the relevant distance and we will calculate the flow resistance and the tubing size required.

A combination of 1/4"/3/16" and 3/8"/5/16" tubing may be used to ensure that there is no large diameter tubing within the lab (i.e. for the first 20 meters from the generator use 3/8"/5/16" and the final 10 meters to the application use 1/4"/3/16" tubing). Keep the connections and bends to a minimum.

Service Requirements

Service Schedule

Purchase Interval	Component	Visit
12 months	Precision Nitrogen Annual Service Kit	www.peakscientific.com/ ordering
	Precision Nitrogen Trace Annual Service Kit	

Peak Protected

With Peak Scientific you invest in not only a product but peace of mind. With a network of certified Peak engineers stationed throughout the globe, Peak's rapid response team are never far away and our commitment is to keep your generator running day in, day out, protecting your laboratory workflow.

[Peak Protected] can provide...



Installation
A dedicated Peak engineer will visit your lab to install and setup your generator



Complete plan
Swift response by a Peak Service Engineer within 72 hours & planned preventative maintenance



Premium Protected
Guaranteed rapid on-site response within 24 hours & planned preventative maintenance



IQ/OQ
Certified assurance for applications requiring documented qualification

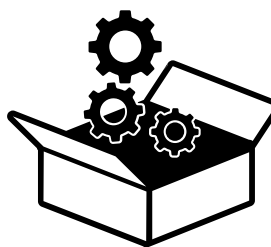

Spares
Genuine Peak parts with express delivery, ensuring optimal performance and lifetime



Technical Support Hotline
Around the clock support by phone or online with our global technical helpdesk

To find out more about protecting your investment visit: www.peakscientific.com/protected

Cleaning

Clean the outside of the generator only using warm soapy water and a clean damp cloth. Ensure all excess fluid is thoroughly removed from the cloth prior to use.



Cleaning should only be undertaken with the power switched off and the power cord removed from the rear of the generator.





Under no circumstances should any solvents or abrasive cleaning solutions be used as these can contain fumes that could be harmful to the generator. Chlorine-based beach cleaning solutions should not be used on the generator or within their operating environment.



Care should be taken with Leak Detections Liquids.

Troubleshooting

Problem	Possible Solution
<p>The generator will not switch on and the power switch does not illuminate.</p>	<ul style="list-style-type: none"> • Ensure power cord is plugged into the generator and that the power socket is turned on. • Check the fuse in the power cord plug. • Contact your service provider. 
<p>The fascia LED's have not illuminated but the power switch is illuminated.</p>	<ul style="list-style-type: none"> • Contact your service provider. 
<p>The instrument is reporting low pressure.</p>	<ul style="list-style-type: none"> • Check for leaks between the generator and instrument. • Contact your service provider.
<p>The fascia Yellow illumination does not change to green/blue.</p>	<ul style="list-style-type: none"> • Contact your service provider.

Go Online or Complete and Return

We know that registering any of your recently purchased products is not the first thing on your mind- but it is very important to both of us. Not all warranties are alike and Peak Scientific stand out against other gas suppliers as we offer a comprehensive, quick response, on-site warranty. This means that in the very unlikely case that your gas generator develops a fault we have rapid support teams on-hand around the world who are able to come to your lab and get you back up and running in no time.

Register for your **comprehensive 12 month on-site warranty** with ease online at www.peakscientific.com/protected.

Alternatively, you can send the completed form to Peak Scientific by post or email at warranty@peakscientific.com.

Go Online or Complete and Return

You can register for your **FREE 12 month Warranty** with ease online at www.peakscientific.com/protected.

Alternatively, you can send the completed form to Peak Scientific by post or email at warranty@peakscientific.com.

Product Warranty Registration			
Contact name			
Email address			
Company			
Address			
City/town			
Postcode			
Country			
Telephone			
Generator serial #			
Model type			
Installation date			
Do you still use an alternative gas solution i.e. cylinders or bulk liquid?	Yes	No	
What gas requirements do you have in your lab?	Hydrogen	Nitrogen	Zero Air

Extend your cover with

Peak Scientific offer comprehensive gas generator after sales support packages. Peak [Protected] aftercare support can guarantee an on-site response within 72 hours*, genuine parts from our ISO9001 approved factory and a 95% first-time fix rate. See our enclosed Peak [Protected] leaflet for further information.

Important!

You have 1 month to register your Peak Scientific product from the date of installation. Once registered the warranty will be honoured for a period of 12 months. If you wish to defer the installation of your generator, you must notify Peak Scientific immediately by emailing warranty@peakscientific.com. For generators that remain unregistered after 1 month from the shipment date, the warranty will be considered active from the date of factory dispatch.

* Complete Plan only

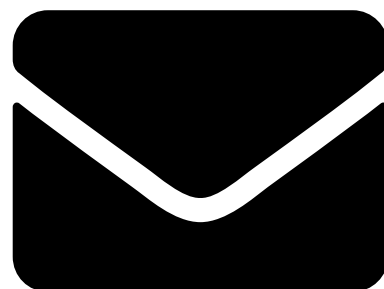
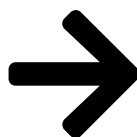
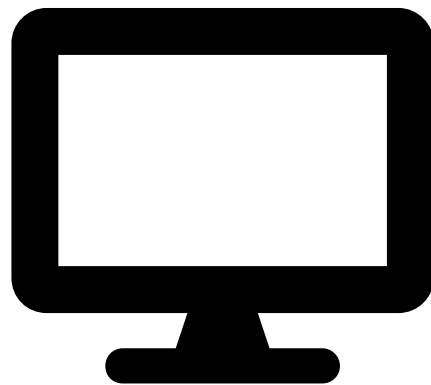

Important!

You have **1 month to register** your Peak Scientific product from the date of installation. Once registered the warranty will be honoured for a period of 12 months. If you wish to defer the installation of your generator, you must notify Peak Scientific immediately by emailing **warranty@peakscientific.com**. For generators that remain unregistered after 1 month from the shipment date, the warranty will be considered active from the date of factory dispatch.

[**PEAK Protected**]TM

Peak Scientific has highly trained, fully certified Field Service Engineers located in over 20 countries across every continent around the world. This allows us to provide an industry-leading rapid response service to our customers. With **[Peak Protected]**, your laboratory's productivity becomes our top priority.

To discuss Peak Protected generator cover and payment options speak to your local Peak Representative or for further information contact: protected@peakscientific.com

Peak Scientific

Fountain Crescent
Inchinnan Business Park
Inchinnan
PA4 9RE
Scotland, UK

Tel: +44 141 812 8100

Fax: +44 141 812 8200

For further information on any of our generator products please contact marketing@peakscientific.com

