

# Genius XE SMZ

User Manual

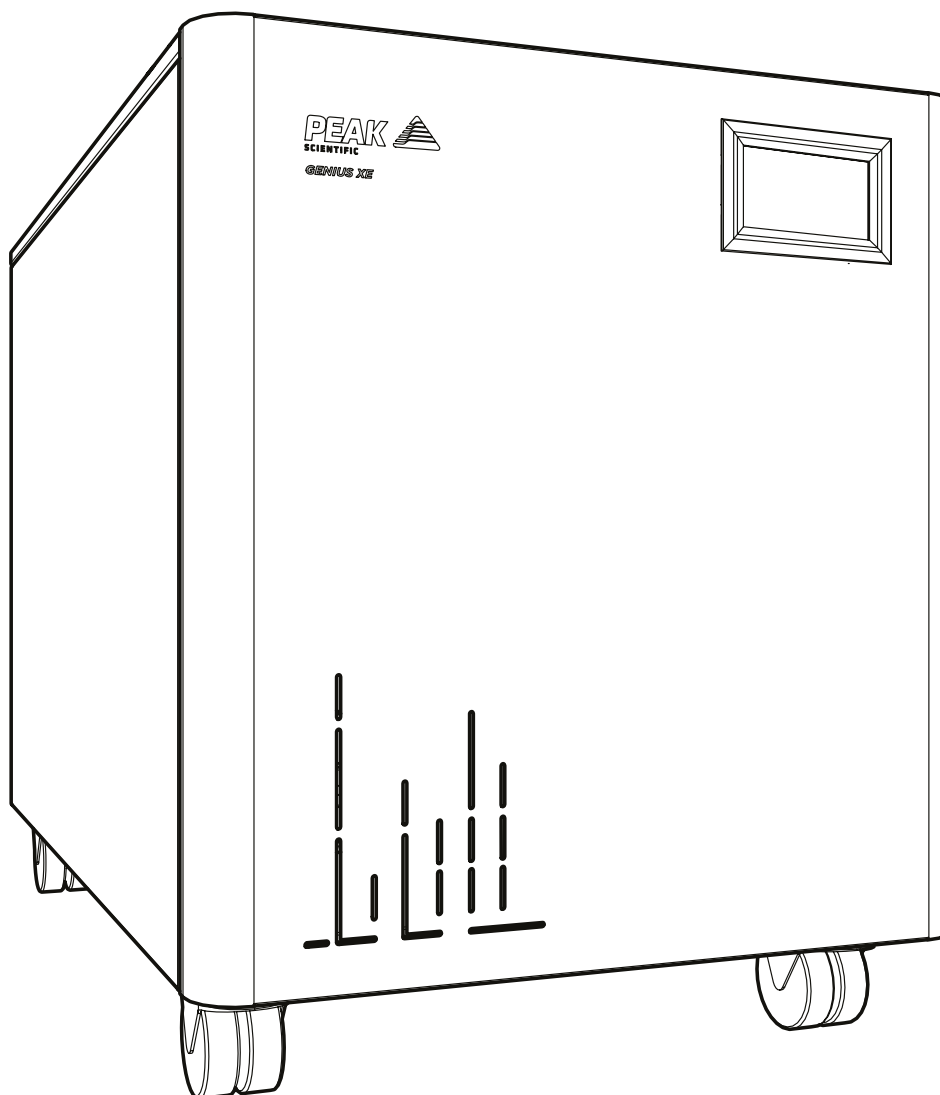

# Register Product to Operate

To begin operation you will need to register your generator. You can do so by **visiting [www.peakscientific.com/activate](http://www.peakscientific.com/activate)** or by **downloading the Peak Genius App**.

Registering will activate your **2 year warranty\*** - covering every single component in your generator.

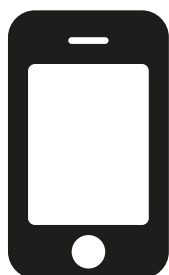

## Important!

You must register your generator before nitrogen generation can commence. In order to be eligible for warranty your generator must be registered to the end user (not a reseller or distributor) and must have a paid annual preventative maintenance arranged within 13 months of the installation date & carried out by a Peak approved Field Service Engineer. Once registered the warranty will be honoured for a period of 24 months.\*\*

\* 2nd year warranty subject to completion of preventative maintenance visit arranged within 13 months of installation. For terms and conditions please visit [www.peakscientific.com/warranty-statement/](http://www.peakscientific.com/warranty-statement/)

\*\* Call out and labour charges may apply where generator was not purchased directly from Peak

# Contents

Change History	4
How to use this Manual	4
Safety Notices	7
Symbols	7
Safety Notice to Users	7
EU Declaration of Conformity	8
UK Declaration of Conformity	9
WEEE Compliance Statement	10
CSA Compliance Statement	11
European Union (EU) and United Kingdom (UK) Class A Compliance statement	12
FCC Class A Compliance Statement	12
Industry Canada Class A emission compliance statement	12
Korea Communications Commission (KCC) statement	12
Technical Specification	13
Unpacking	14
Fittings Kit Contents	15
Installation	16
Generator Environment	16
Generator Overview	17
General Dimensions	17
Genius XE SMZ Rear Connections	18
Drain Connection	19
Electrical Connection	20
Start-Up Sequence	21
Connecting to the application	22
Tubing Lengths	22
Normal Operation	23
On Demand Gas	23
Generator Cycling	23
Unusual Operation	23
Service Requirements	28
Service Schedule	28
Service Indication	29
Stage 1	29
Stage 2	29
Service Indication Reset	29
Peak Protected	30
Cleaning	31
Troubleshooting	32

# Change History

Rev	Comment	Name	Date
1	Initial Release	L. Couttie	09/02/2021
2	Declarations Update	L. Couttie	18/11/2021
3	Power Cable Update	L. Couttie	01/08/2022
4	Weight Correction	L. Couttie	27/01/2023
5	Declarations Update	L. Couttie	04/10/2023
6	Decalarations Update	L. Couttie	30/01/2024
7	Spec. Update	L. Couttie	19/03/2024

## How to use this Manual

This manual is intended for end users and has been written as a reference document where you can skip to the relevant information.

Users can refer to the contents page to find the relevant information.

Please review each of the following sections carefully.

Thank you for selecting Peak Scientific to meet your gas generation needs, and should you require any further assistance or support please do not hesitate to contact Peak Scientific or the Peak Partner from which you purchased your generator.

# Warranties and Liabilities

## Warranty & Liability Coverage

1. Peak warrants that, subject to the provisions in this statement, purchased Peak generators, whether purchased directly from Peak or indirectly via an approved, certified and trained distributor or partner (referred to hereafter as a “Peak Partner”) will comply in all material respects with any specifications referred to in your customer order confirmation and, subject to installation and operational guidelines being followed as described in applicable product manuals, shall be free from any defects in quality of materials or workmanship for a period of one year from the date of installation, provided this takes place within 3 months of factory dispatch.
2. Where the purchased generator is from the Precision Hydrogen series, Peak further warrants that, subject to installation and operational guidelines being followed as described in applicable product manuals, the hydrogen cell shall be free from any defects in quality of materials or workmanship for a total period of three years (inclusive of warranty period specified in clause 1) from date of installation, provided this takes place within 3 months of factory dispatch.
3. Where the purchased generator is from the i-Flow 6000 series, Peak further warrants that, subject to installation and operational guidelines being followed as described in applicable product manuals, the generator shall be free from any defects in quality of materials or workmanship for a total period of two years (inclusive of warranty period specified in clause 1) from the date of installation, provided this takes place within 3 months of factory dispatch and the following provisions have also been met:
  - a. you must purchase a service plan, ensuring the generator is serviced by Peak or a Peak Partner on or before the end of the first 12 months of your ownership, and serviced at least once during each subsequent 12 month period thereafter;
  - b. the generator (and any associated equipment) must have been commissioned by Peak or a Peak Partner;
  - c. the feed air or inlet air supply to the generator must comply with ISO 8573-1:2010 Class 1.2.1 at all times;
  - d. your air compressor, dryer, filtration and oil removal systems must be deemed suitable for use by Peak or a Peak Partner, and must be changed and serviced regularly, in line with the equipment manufacturer’s recommended guidelines; and
  - e. any generator failure or fault that is deemed to have been caused by the failure of any upstream equipment, component, part or system (such as air compressor, air treatment or filtration) will be excluded from the warranty described herein.
4. Where the purchased generator is from the Genius XE range, Peak further warrants that, subject to installation and operational guidelines being followed as described in applicable product manuals, the generator shall be free from any defects in quality of materials or workmanship for a total period of two years (inclusive of warranty period specified in clause 1) from the date of registration, provided the following provisions have also been met:
  - a. The product must be registered within 12 months of the build date, to the end user (registrations to 3rd party resellers or other channel partners will not qualify for the warranty extension).
  - b. You must purchase a service plan, ensuring the generator is serviced by Peak or a Peak Partner on or before the end of the first 13 months of your ownership
  - c. The product is required to be serviced in accordance with manufacturer requirements, preventative maintenance visit must be arranged within 13 months of installation, and the generator must be serviced by Peak, or a Peak Partner within 13 months of installation.
  - d. Products purchased via Peak Partners may be subject to call-out and labor charges, which is at the discretion of the Peak Partner.
5. Peak also warrants that any replacement parts whether purchased (directly from Peak, or via a Peak Partner) or supplied as part of any remedial action undertaken in line with the provisions of clauses 13 and 14, shall be free from any defects in quality of materials or workmanship for a period of 180 days from the date of factory dispatch, provided its installation is performed by Peak or a Peak Partner.
6. This warranty does not exclude Peak’s liability in respect of any claim for death or personal injury to

1. any person, in so far as such can be attributed to negligence or breach of duty of care directly resulting from failure of Peak to comply with the provisions in clauses 1, 2, 3, 4 & 5.

## **Exclusions & Limitations**

2. This warranty does not cover:
  - a. damage, deterioration or malfunction resulting from an alteration or modification to a generator which has not been carried out by Peak or a Peak Partner;
  - b. damage, deterioration or malfunction resulting from what Peak reasonably believes to be abuse, or misuse of a generator by you or any third party;
  - c. liability for accident or neglect (other than pursuant to clause 6);
  - d. maintenance or repairs which have not been carried out by Peak or a Peak Partner;
  - e. operation of a generator or exposure of a generator to environmental conditions that fall out-with operational guidelines as specified in the applicable product user manual; and
  - f. lightning, power surges or any other acts of God or nature.
3. This warranty is non-transferrable. Only the original owner of the generator may benefit from the terms within this statement.
4. Peak shall not be liable in respect of any claim made for costs, damages, losses or expenses (whether consequential, direct, indirect or otherwise) or in any respect howsoever arising including, but not limited to, liability from accident or negligence (other than pursuant to clause 6) that may be suffered by you or any third party.
5. No person or entity is authorised to change the terms and conditions outlined in this warranty statement in any respect, or to create any additional obligations or liabilities for any party involved.
6. This warranty statement supersedes any and all prior warranty agreements between the parties and constitutes the complete, final and exclusive understanding of the parties with respect to the subject matter. All prior negotiations, representations, or promises, whether oral or written, of either party shall be deemed to have been merged herein.
7. If any part of this warranty statement is invalidated, for whatever reason, such part will be deleted and the rest shall remain unaffected, continuing to be in full force and effect.

## **Delivery of Warranty Service**



8. Subject to clause 14, and:
  - a. Peak being notified by you, within the duration of the applicable warranty period, of any defect that you think is subject to any warranty valid under clauses 1, 2, 3, 4 or 5; and
  - b. Peak being permitted to inspect the generators, parts and their installation (along with any relevant packaging)  
Peak shall at its option repair or replace defective generators or parts (including, if necessary, any moving parts and irrespective of runtime). No additional charges will apply, for parts or delivery and, where applicable, labour or travel. Peak will endeavour to deliver this service within 3 working days of your notification.
9. Where, in Peak's reasonable opinion, a defect is subject to an exclusion described in clause 7, Peak reserves the right to charge for parts or delivery and, where applicable, you may also be charged by Peak for call out, labour or travel in respect of any repair or replacement which you authorize Peak to carry out.

# Safety Notices

Peak Scientific Instruments cannot anticipate every possible circumstance which may represent a potential hazard. The warnings detailed within this manual refer to the most likely potential hazards, but by definition cannot be all inclusive. If the user employs an operating procedure, item of equipment or a method of working which is not specifically recommended by Peak Scientific, the user must ensure that the equipment will not be damaged or become hazardous to persons or property.

## Symbols

This manual uses the following symbols to highlight specific areas important to the safe and proper use of the generator.

 WARNING	A WARNING notice denotes a hazard. It calls attention to an operating procedure, process or similar, which if not correctly performed or adhered to, could cause personal injury or in the worst case death. Do not proceed beyond a WARNING notice until the indicated conditions are fully understood or met.
 CAUTION	A CAUTION notice denotes a hazard. It calls attention to an operating procedure, process or similar, which if not correctly performed or adhered to, could cause damage to the generator or the application. Do not proceed beyond a CAUTION notice until the indicated conditions are fully understood or met.
	Caution, risk of electric shock. Ensure power to the generator has been removed before proceeding.

## Safety Notice to Users



These instructions must be read thoroughly and understood before installation and operation of your Peak Generator. Use of the generator in a manner not specified by Peak Scientific MAY impair the SAFETY provided by the equipment.



When handling, operating or carrying out any maintenance, personnel must employ safe engineering practices and observe all relevant local health and safety requirements and regulations. The attention of UK users is drawn to the Health and Safety at Work Act 1974, and the Institute of Electrical Engineers regulations.



If the equipment is used in a manner not specified by the manufacturer, the protection provided by the equipment maybe impaired.

# EU Declaration of Conformity

We Peak Scientific Instruments Ltd.  
Of Fountain Crescent, Inchinnan, Renfrewshire, PA4 9RE

Hereby declare that, this declaration of conformity is issued under the sole responsibility of the manufacturer.

Equipment Type: Nitrogen Generator  
Model Designator: Genius XE SMZ

To which this declaration relates, is in conformity with the following applicable EU Directives, harmonized standards, and other normative requirements.

- **Low Voltage Directive 2014/35/EU**  
EN 61010-1: 2010+ A1:2019 Safety Requirements for Electrical Equipment for Measurement, Control and Laboratory Use.
- **Electromagnetic Compatibility Directive 2014/30/EU**  
EN 61326-1: 2021 Electrical Equipment for Measurement, Control and Laboratory Use - EMC Requirements. (Class A)
- **Restriction on the use of certain hazardous substances in electronic equipment (RoHS) Directive 2011/65/EU as amended by EU 2015/863.**

Signed for and on behalf of Peak Scientific by

Signed:   
Name: Fraser Dunn

Position: Design Engineering Manager  
Peak Scientific Instruments Ltd,  
Inchinnan, Renfrew, Scotland, PA4 9RE, UK.

Date: 5th January 2024





# UK Declaration of Conformity

We Peak Scientific Instruments Ltd.  
Of Fountain Crescent, Inchinnan, Renfrewshire, PA4 9RE

Hereby declare that, this declaration of conformity is issued under the sole responsibility of the manufacturer.

Equipment Type: Nitrogen Generator  
Model Designator: Genius XE SMZ

To which this declaration relates, is in conformity with the following applicable UK Statutory Instruments, Standards and other normative requirements.

- **The Electrical Equipment (Safety) Regulations 2016 (SI 2016 / 1101) as amended.**  
BS61010-1:2010+ A1:2019 Safety Requirements for Electrical Equipment for Measurement Control and Laboratory Use.
- **The Electromagnetic Compatibility Regulations 2016 (SI 2016 / 1091) as amended.**  
BS61326-1:2021 Electrical Equipment for Measurement , Control and Laboratory Use - EMC Requirements. (Class A)
- **The Restriction of the Use of Certain Hazardous Substances in Electrical and Electronic Equipment Regulations 2012 (SI 2012 / 3032) as amended.**

Signed for and on behalf of Peak Scientific by

Signed: 

Name: Fraser Dunn

Position: Design Engineering Manager  
Peak Scientific Instruments Ltd,  
Inchinnan, Renfrew, Scotland, PA4 9RE, UK.

Date: 5th January 2024



# WEEE Compliance Statement

The Waste Electrical and Electronic Equipment (WEEE) Regulations SI 2013 No 3113 and or the Waste Electrical and Electronic Equipment (WEEE) Directive 2012/19/EU apply to all electrical and electronic equipment placed on the market in the UK and EU covered by the scope of regulations which can be found in the Government Guidance Notes (PDF) produced by the Department for Business Innovation and skills for the UK and here for Europe.

All PEAK products that are subject to the WEEE directive are compliant with the WEEE marking requirement. Such products are marked with the “crossed-out wheellie bin” symbol (shown below) in accordance with European standard EN50419. All old electrical equipment can be recycled. Please do not dispose of any electrical equipment (including those marked with this symbol) in general rubbish bins. Please contact your dealer or distributor for clarity.



# CSA Compliance Statement

CSA Group (Canadian Standards Authority) is a Nationally Recognised Testing Laboratory (NRTL), headquartered in Toronto Canada.

They are authorised to evaluate product to both their own and Underwriters Laboratory (UL) standards and certify the product to be in compliance to the relevant standards.

Peak products are certified to the current in force revision of the following standards in order to cover both Canadian and United States requirements for “Safety Requirements for Electrical Equipment for Measurement, Control and Laboratory use, Part 1: general Requirements”.

Canada: CAN/CSA C22.2 No 61010-1-12

United States: UL 61010-1

As a result the products covered by this statement are certified and listed by CSA accordingly and are entitled to carry the CSA mark with both Canadian and United States subscripts , as shown below on the product rating label.



# **EMC Class A Compliance Statements**

## **European Union (EU) and United Kingdom (UK) Class A Compliance statement**

This is a Class A product. In a domestic environment this product may cause radio interference in which case the user may be required to take adequate measures.

## **FCC Class A Compliance Statement**

This equipment has been tested and found to comply with the limits for a Class A digital device, pursuant to part 15 of the FCC Rules. These limits are designed to provide reasonable protection against harmful interference when the equipment is operated in a commercial environment. This equipment generates, uses, and can radiate radio frequency energy and, if not installed and used in accordance with the instruction manual, may cause harmful interference to radio communications. Operation of this equipment in a residential area is likely to cause harmful interference in which case the user will be required to correct the interference at his own expense.



## **Industry Canada Class A emission compliance statement**

This ISM device complies with Canadian ICES-001 (A).

Cet appareil ISM est conforme à la norme NMB-001 (A) du Canada.

## **Korea Communications Commission (KCC) statement**

이 기기는 업무용(A급)으로 전자파적합기기로서 판매자 또는 사용자는 이 점을 주의하시기 바라며, 가정외의 지역에서 사용하는 것을 목적으로 합니다.

(This is electromagnetic wave compatibility equipment for business (Type A). Sellers and users need to pay attention to it. This is for any areas other than home.)

# Technical Specification

## Environment

	Genius XE SMZ
Minimum Operating Ambient Temperature	5°C (41°F)
Maximum Operating Ambient Temperature	30°C (86°F)
Maximum Altitude	3000 m
Maximum Relative Humidity	80% Non-Condensing
Minimum Storage Temperature*	-20°C (-4°F)
Maximum Storage Temperature*	60°C (140°F)

\*NOTE - When taken out of storage the Generator should be allowed to acclimatize at room temperature for a minimum of 3 hours before operation.

## Generator Outlets

Nitrogen Maximum Flow^	27 L/min @ 6.89 bar (0.95 cfm @ 100 psi)
Air Maximum Flow^	29 L/min @ 6.89 bar (1.02 cfm @ 100 psi)
Particles	<0.01µm
Phthalates	NONE
Suspended Liquids	NONE
Gas Outlets	2 x ¼" BSPP
Drain Outlet	1 x ¼" BSPP

## Electrical Requirements

Voltage	220 - 240v ±10%
Frequency	50/60 Hz
Current	9A
Input Connection	C20 Plug
Power Cord	C19 socket to local connection
Pollution Degree	2
Installation / Over Voltage Category	II

## General

Dimensions cm (inches) WxDxH	57 x 89.7 x 70 (22.4 x 35.3 x 27.6)
Generator Weight Kg (lbs)	129 Kg (245 lbs)
Shipping Weight Kg (lbs)	157 Kg (346 lbs)
Heat Output	5186 BTU/hr

# Unpacking

Although Peak Scientific takes every precaution with safe transit and packaging, it is advisable to fully inspect the unit for any sign of transit damage.

Check 'SHOCKWATCH' and 'TIP-N-TELL' labels for signs of rough handling prior to unpacking.

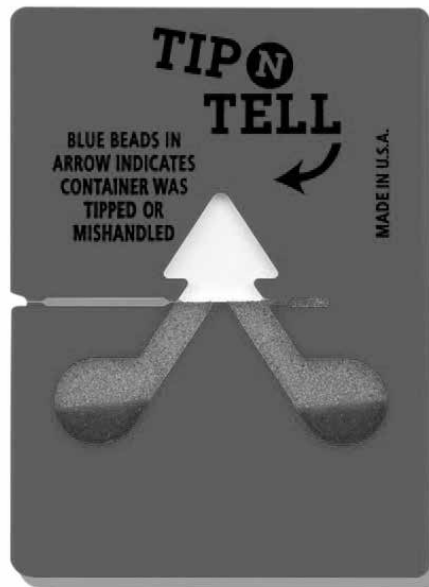

**Any damage should be reported immediately to the carrier and Peak Scientific or the Peak Partner from where the unit was purchased.**

Follow the unpacking instructions posted on the side of the crate. It will require two people to remove the unit from the shipping crate and to manoeuvre the generator to the desired location.

Please save the product packaging for storage or future shipment of the generator.

Note: Included with the generator is a "Fittings Kit" containing mains power leads for UK, EU & US and also all the required fittings and warranty registration card. Be careful not to discard these with the packaging.

## Fittings Kit Contents

Supplied in the Fittings Kit are all the fittings required to connect the generator to the application. The contents of the Fittings Kit are as follows:

1. ¼" Teflon Tubing x 3m	x 3
2. 6mm PE Tubing x 3m	x 3
3. ¼" Compression Fitting	x 2
4. 6mm Push-Fit Fitting	x 3
5. Flow Control Silencer	x 2
6. UK Mains Power Cable 230v	x 1
7. EU Mains Power Cable 230v	x 1
8. US Mains Power Cable 230v	x 1
9. 4mm Hex Key	x 1

All of the generators output ports are located on the output panel at the rear of the unit.

# Installation

## Generator Environment

The generator is designed for indoor use only. It should be installed adjacent to the application it is supplying. If this is not convenient then the unit can be sited elsewhere, however, consideration should be made of the lengths of pipe runs as pressure drops can result from extended runs of pipe.

Performance of the generator is affected by ambient conditions. Please note that the generator's function is primarily to remove Oxygen and Moisture from the generated Nitrogen and/ or Dry Air. Though, depending on model, some hydrocarbon technology may be employed by the generator, in environments with high ambient concentrations of THC additional THC removal filtration may be required, or service life of integrated THC traps may be significantly reduced. Note should also be taken to the proximity of Air Conditioning outlets. These can sometimes give rise to "pockets" of air with high relative humidity. Operation of the unit within such a pocket could adversely affect its performance. Consideration should also be given to the air flow around the unit. It is recommended that an air gap of 100mm (3.9") should be maintained down both sides and at the rear of the unit. Please refer to the drawing on the following page for the general dimensions of the unit.

Please ensure Generator is situated in a well ventilated environment and is positioned to allow easy disconnection from the mains supply if required

Minimum Operating Ambient Temperature: 5 °C (41 °F)

Maximum Operating Ambient Temperature: 30 °C (86 °F)



# Generator Overview

## General Dimensions

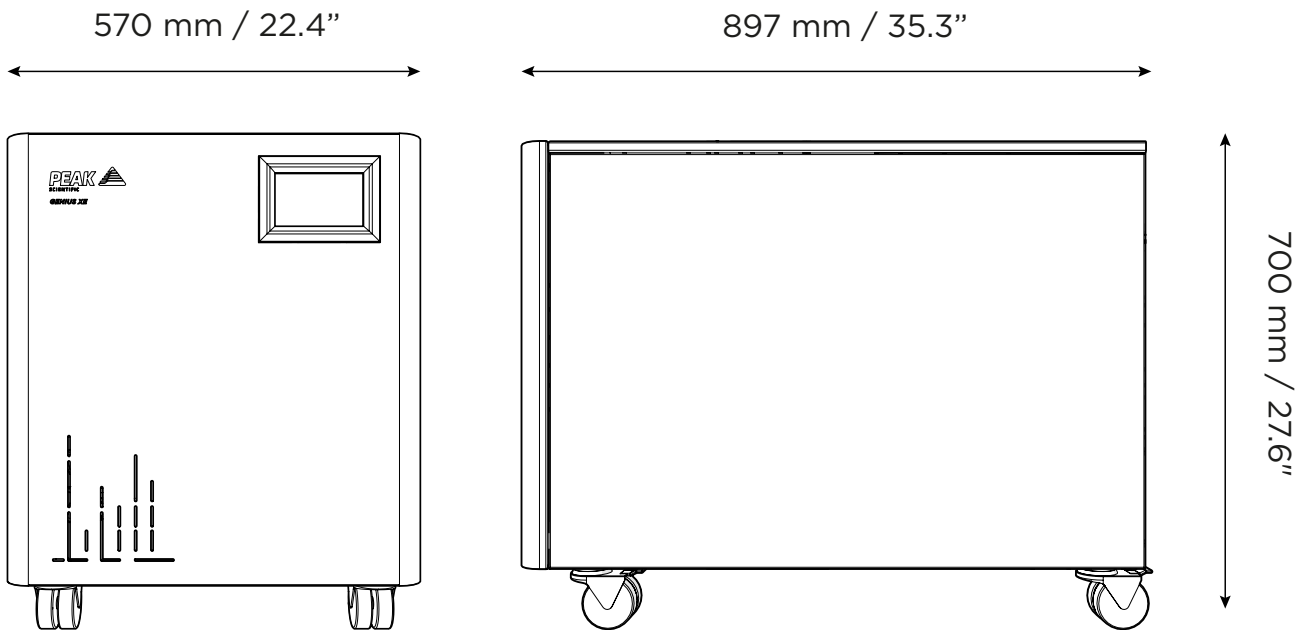

The generator must always be placed on a flat, level surface. Failure to do so will affect the performance of the generator.

## Genius XE SMZ Rear Connections

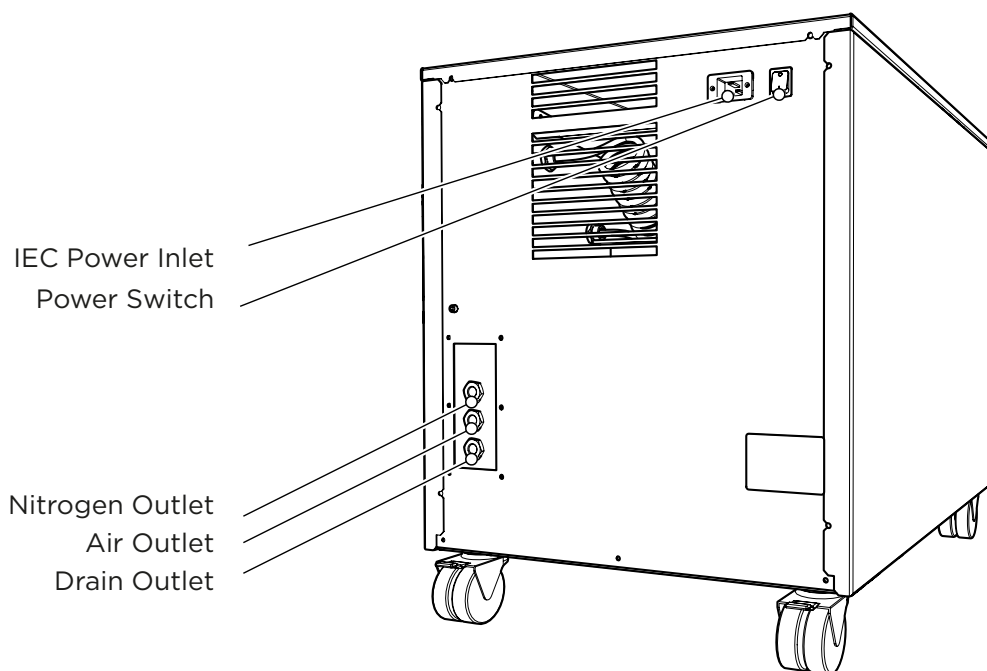

Ensure all inlets and outlets are connected to correct sources and applications



All Connections should only be carried out by trained personnel



Generator must be switched off and unplugged prior to any cleaning or maintenance operations

## Drain Connection

Fit the 6mm push fit fitting to the drain port located on the output panel. Tighten using a 16mm or 5/8" spanner. Use the 6mm tubing to connect this to a suitable drain connection or container. It should be noted that the Generator can expel a considerable amount of water from this (dependant on ambient humidity).



If a container is used it should be emptied at regular intervals. The container must NOT have an air tight seal as water and air are expelled at pressure.

When using this drain bottle, please note below recommendations:

1. A drain bottle should only be connected 1:1 to a single Peak Generator
2. The bottle should not be allowed to be filled with drain water to more than 2/3rds
3. The vent size should not be blocked or restricted in any way.

# Electrical Connection

Connect the generator to an appropriate single-phase supply, refer to the generator serial plate for input specification and ensure your supply matches the requirements.

If an appropriate mains power cords is not supplied or a substitute one is used then ensure that all components of it the plug, cord and connector have adequate ratings for the generator and appropriate approvals for the country of use. Failure to do so could cause damage to the generator or risk overloading of the power cord



This unit is classified as SAFETY CLASS 1. THIS UNIT MUST BE EARTHED. Before connecting the unit to the mains supply, please check the information on the serial plate. The mains supply must be of the stated AC voltage and frequency.

EARTH/GROUND (E):-                      Green & Yellow      or      Green

LIVE (L):-                                      Brown                      or      Black

Neutral (N):-                                  Blue                                  or      White

Electrical requirements are 220 - 240v  $\pm$ 10%. Running at voltages outwith this is not recommended. Extended periods at extremes can have a detrimental effect on the operation and life of the generator.



If the equipment is used in a manner not specified by the manufacturer, the protection provided by the equipment maybe impaired.

## Start-Up Sequence



Before the Generator is connected to the application, the Generator should be operated in isolation (i.e. not connected to the application) for thirty minutes. This is to ensure any impurities present are purged from the system. Failure to do this may harm the application.

Once this is done, the Generator can be re-connected to the mains and switched on.

Pressure will start to build in the internal storage tanks. Once this pressure is reached, the compressors will continue to run until the internal tank upper pressure limit is reached and the compressor has run for a period of at least two minutes.

The compressors will then rest until the internal tank lower pressure limits is reached. Once this limit is reached the compressors will switch back on again. This compressor cycling is normal and will continue throughout the operation of the Generator.

When the system has been operated for a period of 30 minutes, all the internal pipe-work and storage tanks will have been purged with Nitrogen.

The Generator is now purged and the tubes can be connected at the rear of the unit.

## Connecting to the application

Once the initial purge run of 30 minutes has completed, and the generator has been running for 15 mins, (required to reach purity for the application) it is ready to be connected to the application(s)



The pressure in the internal storage tanks must be allowed to dissipate before connecting the generator to the application(s)

Attach the 1/4" compression fittings to the outlets of the generator. Using the 1/4" tubing supplied, connect the outlets of the generator to the inlets on the application.

If you require more tubing than is supplied please refer to the Tubing Lengths section.



Once the tubing is connected to the application, please ensure that it is thoroughly checked for being leak-tight. Even the slightest leak in the gas supply between the generator and the application can lead to a reduction in efficiency.

## Tubing Lengths



The diameter of the tubing which will be connected to the gas outlets is important and is determined by the length of tubing required. Failure to follow these recommendations could lead to pressure between generator and application.

- < 10 meters: Use 1/4"/3/16" (1/4" O/D, 3/16" I/D) P.T.F.E. tubing.
- > 10 - 40 meters: Use 3/8"/5/16" (3/8" O/D, 5/16" I/D). Tubing and fittings not supplied in the fittings kit.
- > 40 metres: Please contact Peak Scientific with the relevant distance and we will calculate the flow resistance and the tubing size required.

A combination of 1/4"/3/16" and 3/8"/5/16" tubing may be used to ensure that there is no large diameter tubing within the lab (i.e. for the first 20 meters from the generator use 3/8"/5/16" and the final 10 meters to the application use 1/4"/3/16" tubing). Keep the connections and bends to a minimum.

## **Normal Operation**

The generator is designed specifically to minimize operator involvement. Given that the system is installed as described in earlier sections and is serviced in accordance with the specified maintenance recommendations (see Service Requirements), then it should simply be a matter of turning the generator on when it is required.

The generator will automatically produce the factory set flow and pressure as detailed in the Technical Specifications.

## **On Demand Gas**

When the application requires a gas flow, the generator will produce gas on demand.

The generator will continue to supply gas whilst the application is in a 'Standby' mode. As soon as a demand is detected from the application, the generator will match the applications requirements.

## **Generator Cycling**

The generator is designed to operate in either a cyclic mode or run continuously, this will be dependent on the output flow.

The cyclic rate of the compressors will depend on the gas demand of the application; the generator will cycle when the upper tank pressure set limits are achieved within a 3-minute time period.

When the application demands increase, the compressor duty will be higher and the rest period of the compressor cycle will be shorter. If operated at maximum flow, the generator will run continuously to maintain the upper tank pressures. Another cause for continuous operation would be if the generator is installed at high altitude, in an extreme environment or subjected to low voltage supply. The compressors will undergo periods where they do not cycle.

## **Unusual Operation**

If at any time the generator begins to emit excessive noise or vibration, then it should be switched off and you should contact Peak Scientific or the Peak Partner from which the generator has been purchased.

# HMI Screens

## Normal Operation

When the generator is powered on it will show the following screens until a system check has been performed.



The checks will last a few seconds then the HMI will show the home screen. Customers can view two screens at this stage.

## Home Screen

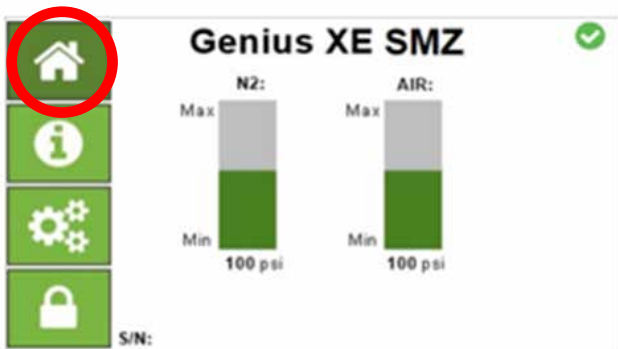

This shows live system pressures.

## Information Screen

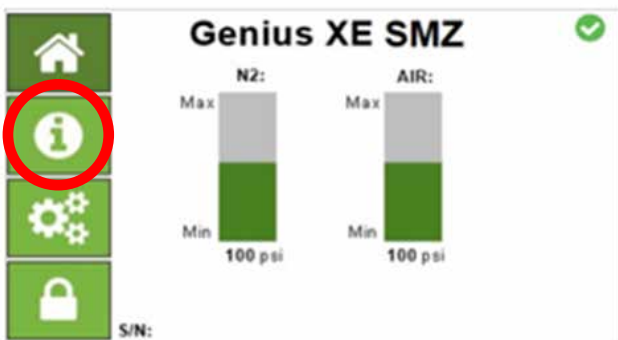



# Troubleshooting

## Service Alarms

When a service is due the LED on the front panel will illuminate and the internal HMI will show the following screens;

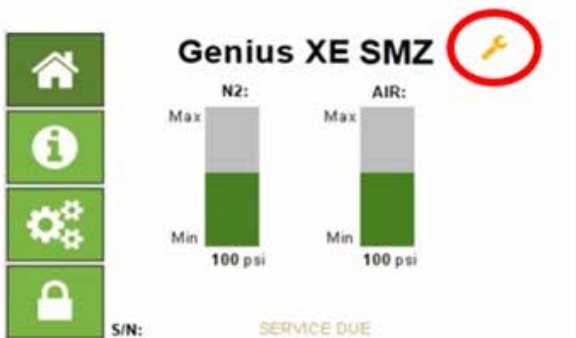

When a service is overdue the HMI will show the following screens;

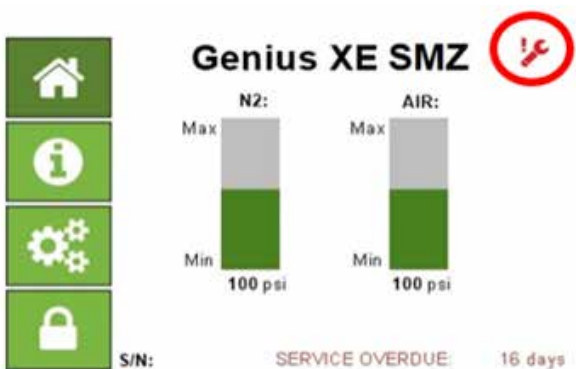

Service due date can be checked through the information screen. Toggle to the run time.



## SMZ Fault Codes

In the event of a fault with an SMZ generator, the HMI will display an amber warning signal along with a fault reference code.

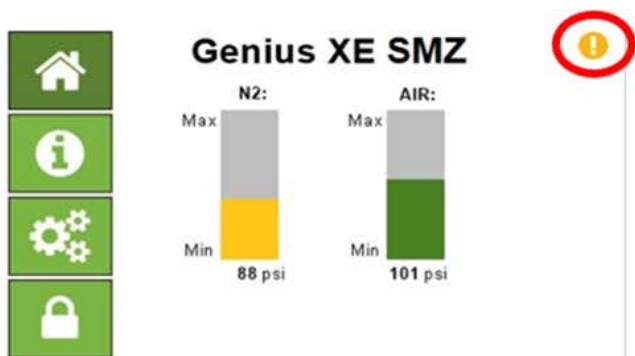

Toggle the warning indicator in the top right corner of the HMI to view warning code.

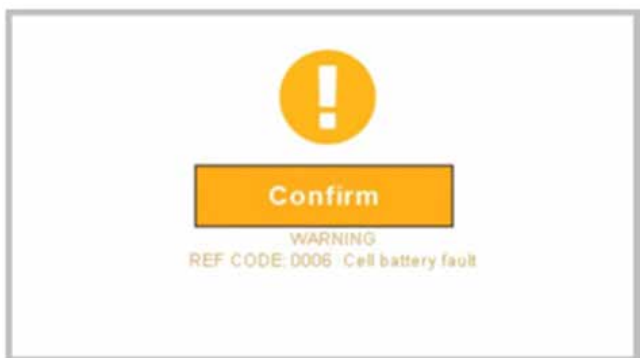

A list of fault codes for the SMZ is shown below;

- REF CODE 0006 = Cell battery failure
- REF CODE 0600 = Low Nitrogen Tank Pressure
- REF CODE 0605 = Low Air Tank Pressure

## SMZ Major Fault Codes

In the event of a major fault with an SMZ generator, the HMI will display a red warning signal along with a fault reference code.



Toggle the warning indicator in the top right corner of the HMI to view warning code.



A list of major fault codes for the SMZ is shown below

REF CODE 0001 = Nitrogen Tank Pressure Sensor Fault

REF CODE 0002 = Air Tank Pressure Sensor Fault

# Service Requirements

## Service Schedule

Purchase Interval	Component	Visit
12 Months	Genius XE SMZ Annual Maintenance Kit*	<a href="http://www.peakscientific.com/ordering">www.peakscientific.com/ordering</a>
4 Years	Genius XE SMZ Year 4 Service Kit*	<a href="http://www.peakscientific.com/ordering">www.peakscientific.com/ordering</a>

\* Please quote your generator serial number when ordering your Maintenance Kit to ensure selection of the appropriate kit for your generator.

# **Service Indication**

The generator has the following Service Indication Stages:-

## **Stage 1**

Once either compressor requires a service the HMI will show a service icon.

This is to make the user aware that a service of the generator is due and should be planned at the earliest convenience. The generator will continue to operate as normal with the HMI service icon showing.

## **Stage 2**

If the service is not completed the generator will continue to run. After 2 weeks, the service HMI will show a service icon.

This is to make the user aware that the service of the generator is now overdue and must be completed immediately to ensure the continuous trouble free operation of the generator.

## **Service Indication Reset**

Once the service has been completed the Service Indication on the HMI can be reset in the main control PCB. This will be performed by the Peak Service Engineer or trained service representative that completes the service operation.

# Peak Protected

With Peak Scientific you invest in not only a product but peace of mind. With a network of certified Peak engineers stationed throughout the globe, Peak's rapid response team are never far away and our commitment is to keep your generator running day in, day out, protecting your laboratory workflow.

**[Peak Protected]** can provide...



**Installation**  
A dedicated Peak engineer will visit your lab to install and setup your generator



**Complete plan**  
Swift response by a Peak Service Engineer within 72 hours & planned preventative maintenance



**Premium Protected**  
Guaranteed rapid on-site response within 24 hours & planned preventative maintenance



**IQ/OQ**  
Certified assurance for applications requiring documented qualification

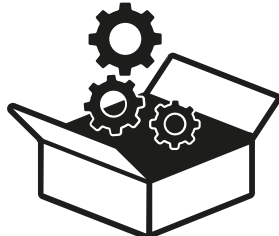

**Spares**  
Genuine Peak parts with express delivery, ensuring optimal performance and lifetime



**Technical Support Hotline**  
Around the clock support by phone or online with our global technical helpdesk

To find out more about protecting your investment visit: [www.peakscientific.com/protected](http://www.peakscientific.com/protected)

## Cleaning

Clean the outside of the generator only using warm soapy water and a clean damp cloth. Ensure all excess fluid is thoroughly removed from the cloth prior to use.



Cleaning should only be undertaken with the power switched off and the power cord removed from the rear of the generator.



CAUTION

Under no circumstances should any solvents or abrasive cleaning solutions be used as these can contain fumes that could be harmful to the generator.



CAUTION

Care should be taken with Leak Detections Liquids.

# Troubleshooting

Problem	Possible Solution
The Generator will not switch on and the power switch does not illuminate.	<ul style="list-style-type: none"><li>• Ensure power cord is plugged into the Generator and that the power socket is turned on.</li><li>• Check the fuse in the power cord plug.</li><li>• Contact your service provider.</li></ul> 
Compressors are running but pressure is not building.	<ul style="list-style-type: none"><li>• Contact your service provider.</li></ul>
The mass spec is reporting low pressure.	<ul style="list-style-type: none"><li>• Contact your service provider.</li></ul>









# [**PEAK Protected**]<sup>TM</sup>

Peak Scientific has highly trained, fully certified Field Service Engineers located in over 20 countries across every continent around the world. This allows us to provide an industry-leading rapid response service to our customers. With [**Peak Protected**], your laboratory's productivity becomes our top priority.

To discuss Peak Protected generator cover and payment options speak to your local Peak Representative or for further information contact: [protected@peakscientific.com](mailto:protected@peakscientific.com)

**Peak Scientific**

Fountain Crescent  
Inchinnan Business Park  
Inchinnan  
PA4 9RE  
Scotland, UK

**Tel:** +44 141 812 8100

**Fax:** +44 141 812 8200

For further information on any of our generator products please contact [marketing@peakscientific.com](mailto:marketing@peakscientific.com)