

# Infinity XE 60 Series

User Manual

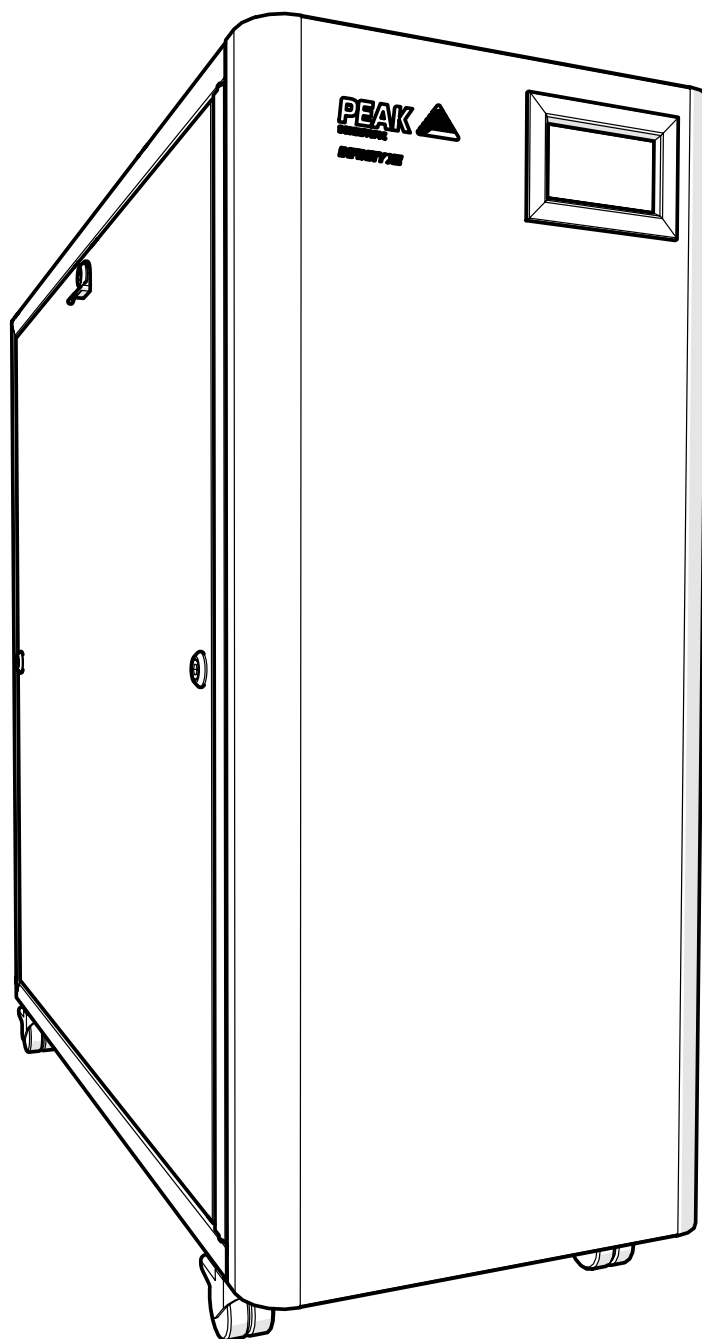

**PEAK**   
SCIENTIFIC

# Contents

Change History	3
How to use this Manual	3
Warranties and Liabilities	4
Warranty & Liability Coverage	4
Safety Notices	6
Symbols	6
Safety Notice to Users	6
EU Declaration of Conformity	7
UK Declaration of Conformity	8
WEEE Compliance Statement	9
CSA Compliance Statement	10
European Union (EU) and United Kingdom (UK) Class A Compliance statement	11
FCC Class A Compliance Statement	11
Industry Canada Class A emission compliance statement	11
Korea Communications Commission (KCC) statement	11
Technical Specification	12
Infinity XE 6010 & 6020	12
Technical Specification	13
Infinity XE 6030 & 6040	13
Unpacking	14
Fittings Kit Contents	15
Installation	16
Generator Environment	16
Inlet Air Quality	16
Generator Overview	17
General Dimensions	17
Rear Connections	18
Electrical Connection	19
Electrical Panel Access	19
Normal Operation	20
On Demand Gas	20
Eco Mode	20
Commissioning	21
Tubing Lengths	21
System Icons	24
Service Requirements	29
Service Schedule	29
Peak Protected	31
Cleaning	32
Safely Isolated Condition	32
Safe State After Repair	32
Troubleshooting	33

# Change History

Rev	Comment	Name	Date
1	Initial Release	L. Couttie	31/05/2021
2	Certification Feedback Updates	L. Couttie	27/08/2021
3	Electrical Req. Updates	L. Couttie	16/09/2021
4	Declarations Update	D. Lai	10/11/2021
5	Text Update	D. Lai	12/01/2022
6	CSA Cert. Added	L. Couttie	08/02/2022
7	ISO Table Update	D.Lai	23/11/2022
8	Flow rate & Branding Update	C Denholm	16/05/2023
9	Declarations Update	L. Couttie	02/10/2023

## How to use this Manual

This manual is intended for end users and has been written as a reference document where you can skip to the relevant information.

Users can refer to the contents page to find the relevant information.

Please review each of the following sections carefully.

Thank you for selecting Peak Scientific to meet your gas generation needs, and should you require any further assistance or support please do not hesitate to contact Peak Scientific or the Peak Partner from which you purchased your generator.

# Warranties and Liabilities

## Warranty & Liability Coverage

1. Peak warrants that, subject to the provisions in this statement, purchased Peak generators, whether purchased directly from Peak or indirectly via an approved, certified and trained distributor or partner (referred to hereafter as a "Peak Partner") will comply in all material respects with any specifications referred to in your customer order confirmation and, subject to installation and operational guidelines being followed as described in applicable product manuals, shall be free from any defects in quality of materials or workmanship for a period of one year from the date of installation, provided this takes place within 3 months of factory dispatch.
2. Where the purchased generator is from the Precision Hydrogen series, Peak further warrants that, subject to installation and operational guidelines being followed as described in applicable product manuals, the hydrogen cell shall be free from any defects in quality of materials or workmanship for a total period of three years (inclusive of warranty period specified in clause 1) from date of installation, provided this takes place within 3 months of factory dispatch.
3. Where the purchased generator is from the i-Flow 6000 & 8000 series, Peak further warrants that, subject to installation and operational guidelines being followed as described in applicable product manuals, the generator shall be free from any defects in quality of materials or workmanship for a total period of two years (inclusive of warranty period specified in clause 1) from the date of installation, provided this takes place within 3 months of factory dispatch and the following provisions have also been met:
  - a. you must purchase a service plan, ensuring the generator is serviced by Peak or a Peak Partner on or before the end of the first 12 months of your ownership, and serviced at least once during each subsequent 12 month period thereafter;
  - b. the generator (and any associated equipment) must have been commissioned by Peak or a Peak Partner;
  - c. the feed air or inlet air supply to the generator must comply with the minimum ISO 8573-1:2010 air class, as specified within relevant product user manual, at all times;
  - d. your air compressor, dryer, filtration and oil removal systems must be deemed suitable for use by Peak or a Peak Partner, and must be changed and serviced regularly, in line with the equipment manufacturer's recommended guidelines; and
  - e. any generator failure or fault that is deemed to have been caused by the failure of any upstream equipment, component, part or system (such as air compressor, air treatment or filtration) will be excluded from the warranty described herein.
4. Where the purchased generator is from the Genius XE range, Peak further warrants that, subject to installation and operational guidelines being followed as described in applicable product manuals, the generator shall be free from any defects in quality of materials or workmanship for a total period of two years (inclusive of warranty period specified in clause 1) from the date of registration, provided the following provisions have also been met:
  - a. The product must be registered within 12 months of the build date, to the end user (registrations to 3rd party resellers or other channel partners will not qualify for the warranty extension).
  - b. You must purchase a service plan, ensuring the generator is serviced by Peak or a Peak Partner on or before the end of the first 13 months of your ownership
  - c. The product is required to be serviced in accordance with manufacturer requirements, preventative maintenance visit must be arranged within 13 months of installation, and the generator must be serviced by Peak, or a Peak Partner within 13 months of installation.
  - d. Products purchased via Peak Partners may be subject to call-out and labor charges, which is at the discretion of the Peak Partner.
5. Peak also warrants that any replacement parts whether purchased (directly from Peak, or via a Peak Partner) or supplied as part of any remedial action undertaken in line with the provisions of clauses 13 and 14, shall be free from any defects in quality of materials or workmanship for a period of 180 days from the date of factory dispatch, provided its installation is performed by Peak or a Peak Partner.
6. This warranty does not exclude Peak's liability in respect of any claim for death or personal injury to any person, in so far as such can be attributed to negligence or breach of duty of care directly resulting

from failure of Peak to comply with the provisions in clauses 1, 2, 3, 4 & 5.

## **Exclusions & Limitations**

7. This warranty does not cover:
  - a. Damage, deterioration or malfunction resulting from an alteration or modification to a generator which has not been carried out by Peak or a Peak Partner;
  - b. Damage, deterioration or malfunction resulting from what Peak reasonably believes to be abuse, or misuse of a generator by you or any third party;
  - c. Liability for accident or neglect (other than pursuant to clause 6);
  - d. Maintenance or repairs which have not been carried out by Peak or a Peak Partner;
  - e. Operation of a generator or exposure of a generator to environmental conditions that fall out-with operational guidelines as specified in the applicable product user manual; and
  - f. Lightning, power surges or any other acts of God or nature.
8. This warranty is non-transferrable. Only the original owner of the generator may benefit from the terms within this statement.
9. Peak shall not be liable in respect of any claim made for costs, damages, losses or expenses (whether consequential, direct, indirect or otherwise) or in any respect howsoever arising including, but not limited to, liability from accident or negligence (other than pursuant to clause 6) that may be suffered by you or any third party.
10. No person or entity is authorised to change the terms and conditions outlined in this warranty statement in any respect, or to create any additional obligations or liabilities for any party involved.
11. This warranty statement supersedes any and all prior warranty agreements between the parties and constitutes the complete, final and exclusive understanding of the parties with respect to the subject matter. All prior negotiations, representations, or promises, whether oral or written, of either party shall be deemed to have been merged herein.
12. If any part of this warranty statement is invalidated, for whatever reason, such part will be deleted and the rest shall remain unaffected, continuing to be in full force and effect.

## **Delivery of Warranty Service**



13. Subject to clause 14, and:
  - a. Peak being notified by you, within the duration of the applicable warranty period, of any defect that you think is subject to any warranty valid under clauses 1, 2, 3, 4 or 5; and
  - b. Peak being permitted to inspect the generators, parts and their installation (along with any relevant packaging) Peak shall at its option repair or replace defective generators or parts (including, if necessary, any moving parts and irrespective of runtime). No additional charges will apply, for parts or delivery and, where applicable, labor or travel. Peak will endeavour to deliver this service within 3 working days of your notification.
14. Where, in Peak's reasonable opinion, a defect is subject to an exclusion described in clause 7, Peak reserves the right to charge for parts or delivery and, where applicable, you may also be charged by Peak for call out, labor or travel in respect of any repair or replacement which you authorize Peak to carry out.

# Safety Notices

Peak Scientific Instruments cannot anticipate every possible circumstance which may represent a potential hazard. The warnings detailed within this manual refer to the most likely potential hazards, but by definition cannot be all inclusive. If the user employs an operating procedure, item of equipment or a method of working which is not specifically recommended by Peak Scientific, the user must ensure that the equipment will not be damaged or become hazardous to persons or property.

## Symbols

This manual uses the following symbols to highlight specific areas important to the safe and proper use of the generator.

 WARNING	A WARNING notice denotes a hazard. It calls attention to an operating procedure, process or similar, which if not correctly performed or adhered to, could cause personal injury or in the worst case death. Do not proceed beyond a WARNING notice until the indicated conditions are fully understood or met.
 CAUTION	A CAUTION notice denotes a hazard. It calls attention to an operating procedure, process or similar, which if not correctly performed or adhered to, could cause damage to the generator or the application. Do not proceed beyond a CAUTION notice until the indicated conditions are fully understood or met.
	Caution, risk of electric shock. Ensure power to the generator has been removed before proceeding.

## Safety Notice to Users



These instructions must be read thoroughly and understood before installation and operation of your Peak Generator. Use of the generator in a manner not specified by Peak Scientific MAY impair the SAFETY provided by the equipment.



When handling, operating or carrying out any maintenance, personnel must employ safe engineering practices and observe all relevant local health and safety requirements and regulations. The attention of UK users is drawn to the Health and Safety at Work Act 1974, and the Institute of Electrical Engineers regulations.



If the equipment is used in a manner not specified by the manufacturer, the protection provided by the equipment maybe impaired.

# EU Declaration of Conformity

We Peak Scientific Instruments Ltd.  
Of Fountain Crescent, Inchinnan, Renfrewshire, PA4 9RE

Hereby declare that, this declaration of conformity is issued under the sole responsibility of the manufacturer.

Equipment Type: Nitrogen Gas Generator  
Model Designator: Infinity XE 60 Series

To which this declaration relates, is in conformity with the following applicable EU Directives, harmonized standards, and other normative requirements.

- **Low Voltage Directive 2014/35/EU**  
EN 61010-1: 2010/ A1:2019 Safety Requirements for Electrical Equipment for Measurement, Control and Laboratory Use.
- **Electromagnetic Compatibility Directive 2014/30/EU**  
EN 61326-1: 2013 Electrical Equipment for Measurement, Control and Laboratory Use - EMC Requirements. (Class A)
- **Restriction on the use of certain hazardous substances in electronic equipment (RoHS) Directive 2011/65/EU as amended by EU 2015/863.**

Signed for and on behalf of Peak Scientific by

Signed: 

Name: Fraser Dunn

Position: Design Engineering Manager  
Peak Scientific Instruments Ltd,  
Inchinnan, Renfrew, Scotland, PA4 9RE, UK.

Date: 15th October 2021



# UK Declaration of Conformity

We Peak Scientific Instruments Ltd.  
Of Fountain Crescent, Inchinnan, Renfrewshire, PA4 9RE

Hereby declare that, this declaration of conformity is issued under the sole responsibility of the manufacturer.

Equipment Type: Nitrogen Gas Generator  
Model Designator: Infinity XE 60 Series

To which this declaration relates, is in conformity with the following applicable UK Statutory Instruments, Standards and other normative requirements.

- **The Electrical Equipment (Safety) Regulations 2016 (SI 2016 / 1101) as amended.**  
BS61010-1:2010 / A1:2019 Safety Requirements for Electrical Equipment for Measurement Control and Laboratory Use.
- **The Electromagnetic Compatibility Regulations 2016 (SI 2016 / 1091) as amended.**  
BS61326-1:2013 Electrical Equipment for Measurement , Control and Laboratory Use - EMC Requirements. (Class A)
- **The Restriction of the Use of Certain Hazardous Substances in Electrical and Electronic Equipment Regulations 2012 (SI 2012 / 3032) as amended.**

Signed for and on behalf of Peak Scientific by

Signed: 

Name: Fraser Dunn

Position: Design Engineering Manager  
Peak Scientific Instruments Ltd,  
Inchinnan, Renfrew, Scotland, PA4 9RE, UK.

Date: 15th October 2021





# WEEE Compliance Statement

The Waste Electrical and Electronic Equipment (WEEE) Regulations SI 2013 No 3113 and or the Waste Electrical and Electronic Equipment (WEEE) Directive 2012/19/EU apply to all electrical and electronic equipment placed on the market in the UK and EU covered by the scope of regulations which can be found in the Government Guidance Notes (PDF) produced by the Department for Business Innovation and skills for the UK and here for Europe.

All PEAK products that are subject to the WEEE directive are compliant with the WEEE marking requirement. Such products are marked with the “crossed-out wheellie bin” symbol (shown below) in accordance with European standard EN50419. All old electrical equipment can be recycled. Please do not dispose of any electrical equipment (including those marked with this symbol) in general rubbish bins. Please contact your dealer or distributor for clarity.



# CSA Compliance Statement

CSA Group (Canadian Standards Authority) is a Nationally Recognised Testing Laboratory (NRTL), headquartered in Toronto Canada.

They are authorised to evaluate product to both their own and Underwriters Laboratory (UL) standards and certify the product to be in compliance to the relevant standards.

Peak products are certified to the current in force revision of the following standards in order to cover both Canadian and United States requirements for “Safety Requirements for Electrical Equipment for Measurement, Control and Laboratory use, Part 1: general Requirements”.

Canada: CAN/CSA C22.2 No 61010-1-12

United States: UL 61010-1

As a result the products covered by this statement are certified and listed by CSA accordingly and are entitled to carry the CSA mark with both Canadian and United States subscripts , as shown below on the product rating label.



# **EMC Class A Compliance Statements**

## **European Union (EU) and United Kingdom (UK) Class A Compliance statement**

This is a Class A product. In a domestic environment this product may cause radio interference in which case the user may be required to take adequate measures.

## **FCC Class A Compliance Statement**

This equipment has been tested and found to comply with the limits for a Class A digital device, pursuant to part 15 of the FCC Rules. These limits are designed to provide reasonable protection against harmful interference when the equipment is operated in a commercial environment. This equipment generates, uses, and can radiate radio frequency energy and, if not installed and used in accordance with the instruction manual, may cause harmful interference to radio communications. Operation of this equipment in a residential area is likely to cause harmful interference in which case the user will be required to correct the interference at his own expense.



## **Industry Canada Class A emission compliance statement**

This ISM device complies with Canadian ICES-001 (A).

Cet appareil ISM est conforme à la norme NMB-001 (A) du Canada.

## **Korea Communications Commission (KCC) statement**

이 기기는 업무용(A급)으로 전자파적합기기로서 판매자 또는 사용자는 이 점을 주의하시기 바라며, 가정외의 지역에서 사용하는 것을 목적으로 합니다.

(This is electromagnetic wave compatibility equipment for business (Type A). Sellers and users need to pay attention to it. This is for any areas other than home.)

# Technical Specification

## Infinity XE 6010 & 6020

### Environment

	6010	6020
Minimum Operating Ambient Temperature	5°C (41°F)	
Maximum Operating Ambient Temperature	30°C (86°F)	
Maximum Altitude	3000m	
Maximum Relative Humidity	80%	

\* Maximum safety ambient temperature 30°C

\*\* When taken out of storage the generator should be allowed to acclimatize at room temperature for a minimum of 3 hours before operation.

### Inlet Conditions

Minimum Air Inlet Pressure	4.1 bar (60 psi)
Maximum Air Inlet Pressure	9.9 bar (145 psi)
Minimum Air Inlet Flow	Dependant on required flow and purity
Minimum Air Quality	ISO 8573-1:2010 Class [1.4.1]

### Generator Outlets

Maximum Pressure Drop (Inlet-Outlet)	0.7bar (10psi)	
Maximum Outlet Flow (95% Nitrogen)	130 L/min	260 L/min
Outlet Nitrogen Purity	95 - 99.5%	
Start-Up Time	30 minutes	
Particles	<0.01µm	
Pressure Gauges	2	
(Optional) Dry Air Outlet Pressure	Up to 135Psi (depending on inlet supply)	
(Optional) Dry Air Outlet Flow	Up to 210 L/min (depending on inlet supply)	

### Electrical Requirements

Voltage	100-240 V +/-10%	
Frequency	50/60 Hz	
Current	0.5-0.25A	
Input Connection	C20 Plug	
Power Cord	C19 socket to local connection (13A min 16A Max)	
Pollution Degree	2	
Over Voltage Category	II	

### General

Dimensions cm (inches) WxDxH	41 x 95 x 99.5 (16.2 x 37.4 x 39.2)	
Generator Weight Kg (lbs)	80 kg (176.4 lb)	82.5 kg (182 lb)
Shipping Weight Kg (lbs)	92.5 kg (204 lb)	95 kg (210 lb)

# Technical Specification

## Infinity XE 6030 & 6040

### Environment

	6030	6040
Minimum Operating Ambient Temperature	5°C (41°F)	
Maximum Operating Ambient Temperature	30°C (86°F)	
Maximum Altitude	3000m	
Maximum Relative Humidity	80%	

\* Maximum safety ambient temperature 30°C

\*\* When taken out of storage the generator should be allowed to acclimatize at room temperature for a minimum of 3 hours before operation.

### Inlet Conditions

Minimum Air Inlet Pressure	4.1 bar (60 psi)
Maximum Air Inlet Pressure	9.9 bar (145 psi)
Minimum Air Inlet Flow	Dependant on required flow and purity
Minimum Air Quality	ISO 8573-1:2010 Class [1.4.1]

### Generator Outlets

Maximum Pressure Drop (Inlet-Outlet)	1.4bar (20psi)	
Maximum Outlet Flow (95% Nitrogen)	390 L/min	500 L/min
Outlet Nitrogen Purity	95 - 99.5%	
Start-Up Time	30 minutes	
Particles	<0.01µm	
Pressure Gauges	2	
(Optional) Dry Air Outlet Pressure	Up to 135Psi (depending on inlet supply)	
(Optional) Dry Air Outlet Flow	Up to 210 L/min (depending on inlet supply)	

### Electrical Requirements

Voltage	100-240 V +/-10%	
Frequency	50/60 Hz	
Current	0.5-0.25A	
Input Connection	C20 Plug	
Power Cord	C19 socket to local connection (13A min 16A Max)	
Pollution Degree	2	
Over Voltage Category	II	

### General

Dimensions cm (inches) WxDxH	41 x 95 x 99.5 (16.2 x 37.4 x 39.2)	
Generator Weight Kg (lbs)	85 kg (187.4 lb)	87.5 kg (193 lb)
Shipping Weight Kg (lbs)	97.5 kg (215 lb)	100 kg (220.5 lb)

# Unpacking

Although Peak Scientific takes every precaution with safe transit and packaging, it is advisable to fully inspect the unit for any sign of transit damage.

Check 'SHOCKWATCH' and 'TIP-N-TELL' labels for signs of rough handling prior to unpacking

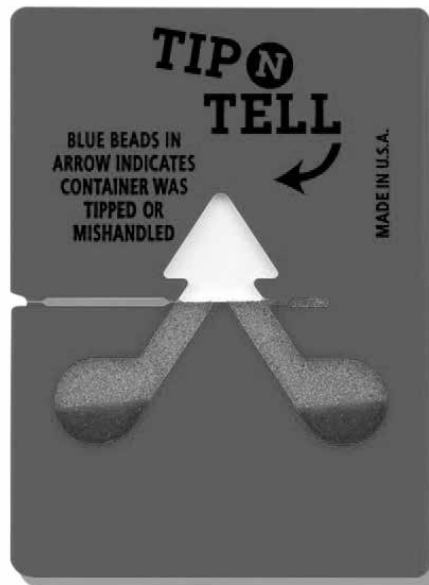

Any damage should be reported immediately to the carrier and Peak Scientific or the Peak Partner from where the unit was purchased.

Follow the unpacking instructions posted on the side of the crate. It will require two people to remove the unit from the shipping crate and to manoeuvre the generator to the desired location.

Please save the product packaging for storage or future shipment of the generator.

Note: Included with the generator is a "Fittings Kit" containing mains power leads for UK, EU & US and also all the required fittings and warranty registration card. Be careful not to discard these with the packaging.

## **Fittings Kit Contents**

Supplied in the Fittings Kit are all the fittings required to connect the generator to the application. The contents of the Fittings Kit are as follows:

1. 6mm PE Tubing	x 3m
2. 12mm PE Tubing	x 3m*
3. 6mm Push-Fit Fitting	x 1
4. 12mm Push-Fit Fitting	x 2
5. 16mm Push-Fit Fitting	x 1
6. Tee Fitting	x 1
7. Shut Off Valve	x 1
8. UK Mains Power Cable	x 1
9. EU Mains Power Cable	x 3
10. JP Mains Power Cable	x 3
11. US Mains Power Cable 230v	x 1
12. US Mains Power Cable 110v	x 1
13. 8mm Hex Key	x 1

All of the generators output ports are located on the output panel at the rear of the unit.

\* x2 with Air Dryer Option

# Installation

## Generator Environment

The generator is designed for indoor use only. It should be installed adjacent to the application(s) it is supplying. If this is not convenient then the unit can be sited elsewhere, however, consideration should be made of the lengths of pipe runs as pressure drops can result from extended runs of pipe.

Performance of the generator is affected by ambient conditions. Please note that the generator’s function is primarily to remove Oxygen and Moisture from the generated Nitrogen and/ or Dry Air. Though, depending on model, some hydrocarbon technology may be employed by the generator, in environments with high ambient concentrations of THC additional THC removal filtration may be required, or service life of integrated THC traps may be significantly reduced. Note should also be taken to the proximity of Air Conditioning outlets. These can sometimes give rise to “pockets” of air with high relative humidity. Operation of the unit within such a pocket could adversely affect its performance. Consideration should also be given to the air flow around the unit. **It is recommended that an air gap of 100mm (3.9”) should be maintained down both sides and at the rear of the unit.** Please refer to the drawing on the following page for the general dimensions of the unit.

Please ensure Generator is situated in a well ventilated environment and is positioned to allow easy disconnection from the mains supply if required.

**Please ensure generator is positioned in such a way that it can be easily disconnected from the mains if necessary.**

Minimum Operating Ambient Temperature: 5 °C (41 °F)

Maximum Operating Ambient Temperature: 30 °C (86 °F)

## Inlet Air Quality

The Nitrogen Generator should be connected to an ISO 8573-1:2010 (1:4:1) source of compressed air. A minimum pressure of 60 Psig is required for efficient operation of the Generator. Any doubts as to the suitability of your compressed air supply should be referred to the factory for advice.

### A MAXIMUM OIL VAPOUR CONTENT OF 0.01 mg per m<sup>3</sup> is PERMISSIBLE

Air Inlet, Nitrogen Outlet and Air outlet connections are at the rear of the generator. The Air inlet connection is a 16mm Push-Fit Fitting. Outlet ports for both Air and Nitrogen are 12mm Push-Fit Fitting, with optional depressurising valves included in the fittings kit for the nitrogen outlet. The Drain Outlet is a 6mm Push-Fit Fitting.

ISO 8573-1:2010 Compressed Air Contaminants and Purity Classes								
Class	Particulate				Water			Oil
	By Particulate Size (maximum number of particles per m <sup>3</sup> )			By Mass	Vapour Pressure Dewpoint		Liquid	Liquid, Aerosol & Vapor
	0.10 - 0.5 microns	0.5 - 1.0 microns	1.0 - 5.0 microns	mg/m <sup>3</sup>	°C	°F	g/m <sup>3</sup>	mg/m <sup>3</sup>
0	As specified by the equipment user or supplier and more stringent than class 1							
1	≤20,000	≤400	≤10		≤-70	≤-94		≤0.01
2	≤400,000	≤6000	≤100		≤-40	≤-40		≤0.1
3		≤90000	≤1000		≤-20	≤-4		≤1
4			≤10000		≤+3	≤+37		≤5
5			≤100000		≤+7	≤+45		
6				0 - ≤5	≤+10	≤+50		
7				5 - ≤10			≤0.5	
8							≤5	
9							≤10	
X				>10			>10	>5



# Generator Overview

## General Dimensions

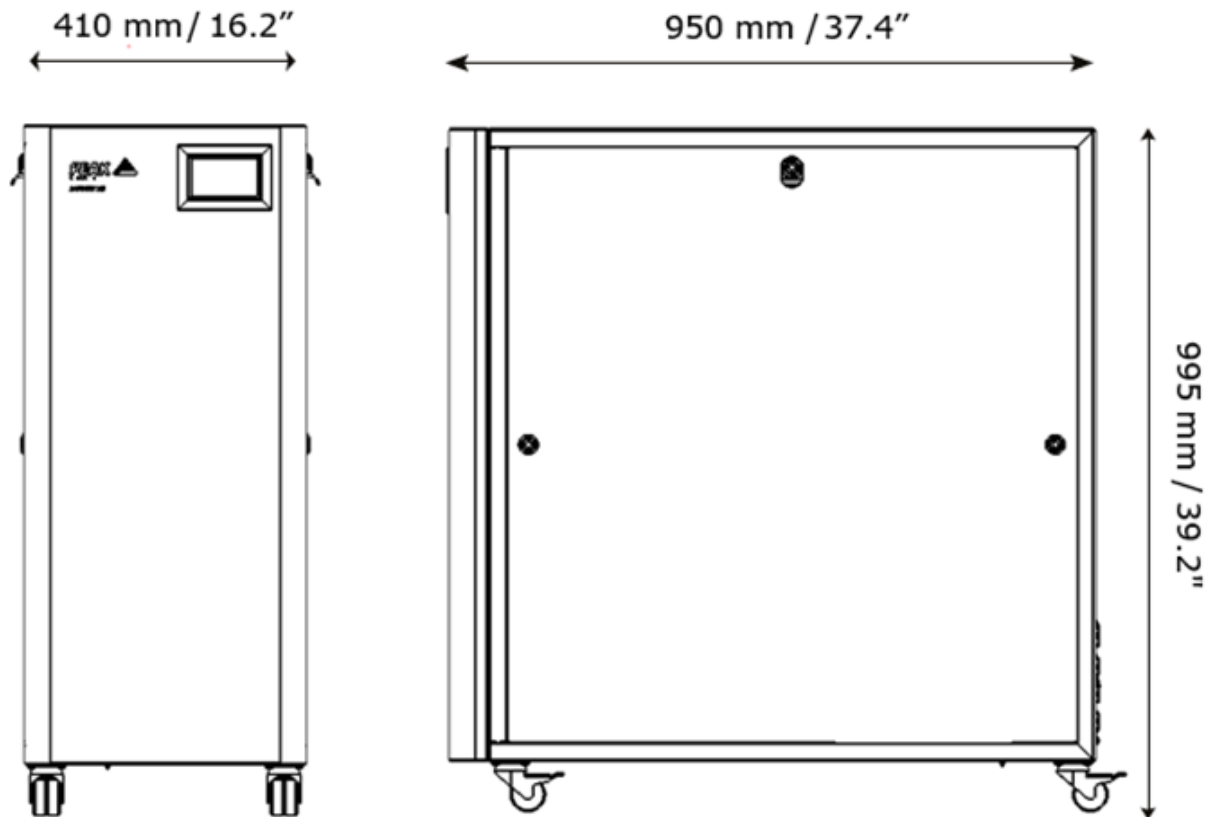

The generator must always be placed on a flat, level surface. Failure to do so will affect the performance of the generator.



Ensure all inlets and outlets are connected to correct sources and applications



All Connections should only be carried out by trained personnel



Generator must be switched off and unplugged prior to any cleaning or maintenance operations

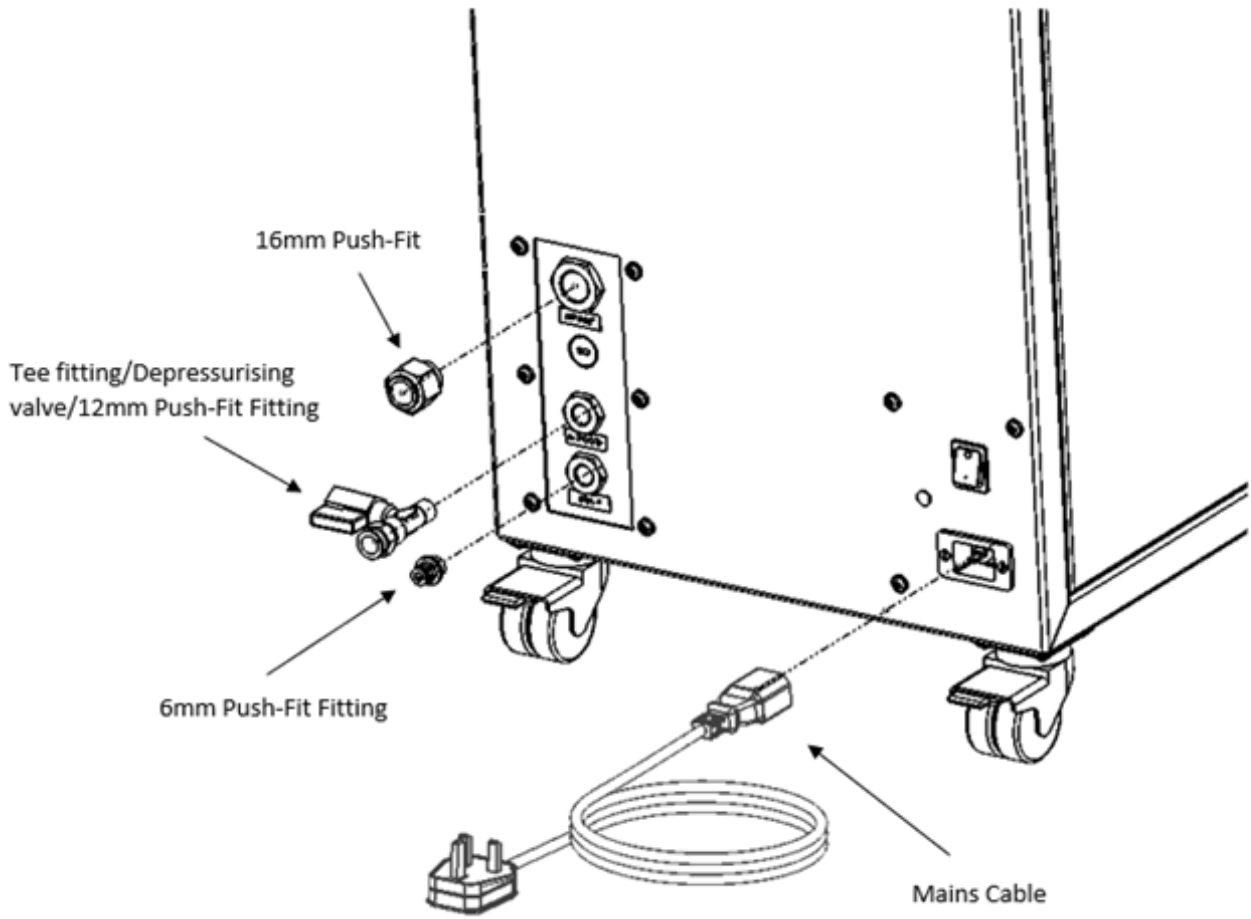

**XE60 Outlet fittings**  
(standard)

**XE60 Outlet fittings**  
(with Dry Air option fitted)

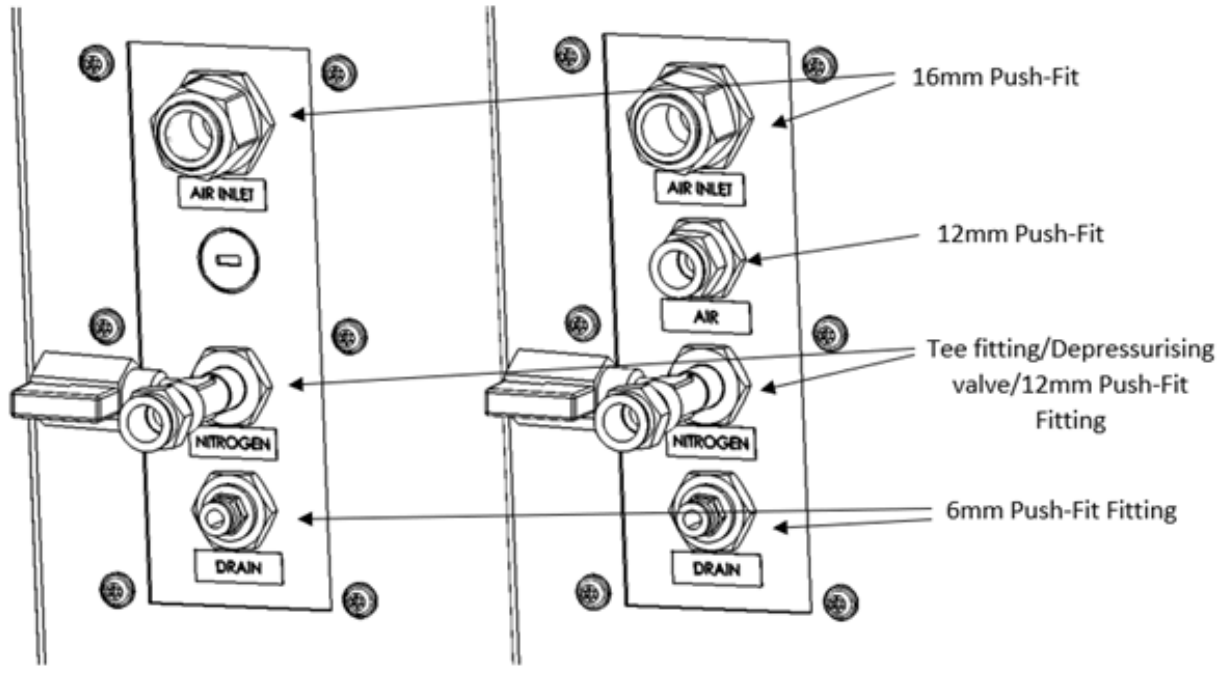

# Electrical Connection

Connect the generator to an appropriate 100-230 volt single-phase supply, refer to the generator serial plate for input specification and ensure your supply matches the requirements.

If the appropriate power cord is not supplied; a new plug, rated to at least 12 amps, can be fitted by a qualified electrician.



This unit is classified as SAFETY CLASS 1. THIS UNIT MUST BE EARTHED. Before connecting the unit to the mains supply, please check the information on the serial plate. The mains supply must be of the stated AC voltage and frequency.

EARTH/GROUND (E):-	Green & Yellow	or	Green
LIVE (L):-	Brown	or	Black
Neutral (N):-	Blue	or	White

# Electrical Panel Access



Changing settings within this enclosure may adversely affect the operation of the generator. This enclosure should not be accessed unless by or under direct instruction from a trained individual.

If an appropriate mains power cords is not supplied or a substitute one is used then ensure that all components of it the plug, cord and connector have adequate ratings for the generator and appropriate approvals for the country of use. Failure to do so could cause damage to the generator or risk overloading of the power cord.

## **Normal Operation**

The Infinity XE 60 Series Gas Generators are designed specifically to minimize operator involvement. Given that the systems are installed as described in earlier sections and is serviced in accordance with the specified maintenance recommendations (see Service Requirements), then it should simply be a matter of turning the Generator on when it is required.

The Generator will produce gas depending on the purity setting at point of installation and detected flow/pressure of inlet compressed air.

## **On Demand Gas**

The generator will produce nitrogen on demand. If the application is operating and requires a gas flow, the system it is connected to will supply this to suit the requirements of the application. If the application requirement for gas stops, the system will also stop. If the demand from the application starts again, the system will detect the demand for gas and will automatically start again to suit the demand. If the unit has been fitted with the optional Dry Air output, the same principle applies to both N<sub>2</sub> and Air outlets.

## **Eco Mode**

When demand from the instrument stops, Infinity XE60 generator will stop demanding air from the external compressor. If demand from the application starts again, the system will detect the demand for gas and will automatically start up again. Please note this does not apply if there is a nitrogen demand from instruments during stand-by mode. If your instruments take a nitrogen flow during stand-by mode, the Infinity XE 60 generator will continue to have to draw compressed air to satisfy the demand.

The generator constantly monitors the flows and pressures within the system and can make calculations on optimal operating conditions based on the flow and pressure demand from the application. XE60 generators fitted with two or more membranes are able 'shut down' certain membranes in order to save supply air. The generator calculates when the optimal number of membranes to use for the measured flow and pressure, meaning it can instantly shut down or turn back on membranes to react to the change in demand. This helps save wasted gas from purging through the unused membranes during low demand periods.

## Commissioning

With the generator installed as previously described, connect the application to the Nitrogen output port and open the air supply to the unit. On reaching operational pressure the generator will produce Nitrogen at the customer-specified purity. The design of the generator is such that it will deliver up to the rated output flow of Nitrogen, determined by demand of the consuming equipment. Rated flow, purity and pressure are installation specific and dependent on inlet conditions being met as detailed on the individual generator

The design of the generator is that it will deliver variable purity dependant on the inlet pressure and outlet flow rate. Outlet pressure may be adjusted by the pressure regulator inside the unit, allowing for up to 15 psi pressure drop across the system. Should the demand for the nitrogen stop, the generator will automatically go into "eco-mode" (refer to page 18), shutting off the air inlet. Once the demand restarts the generator automatically resumes producing Nitrogen. If the generator has been fitted with the optional Dry Air output, the same operating principle applies to the Air output. The generator is protected from over pressurising and will experience a safety valve offload if internal pressure reach above 145Psi.

## Tubing Lengths



CAUTION

The diameter of the tubing which will be connected to the gas outlet is important and is determined by the length of tubing required. Failure to follow these recommendations could lead to pressure between generator and application.

> 10 - 40 meters: Use 12/10 (12mm O/D, 10mm I/D) Tubing.

> 40 metres: Please contact Peak Scientific with the relevant distance and we will calculate the flow resistance and the tubing size required.

The imperial equivalents are: 12/10 = 1/2" O/D, 3/8" I/D.

**Air input tubing is not supplied. 16mm OD, 12mm ID PTFE Tubing is recommended.**

# HMI Screens

## Normal Operation

When the generator is powered on it will show the following screens until a system check has been performed.



The checks will last a few seconds then the HMI will show the home screen. Customers can view two screens at this stage.

## Home Screen

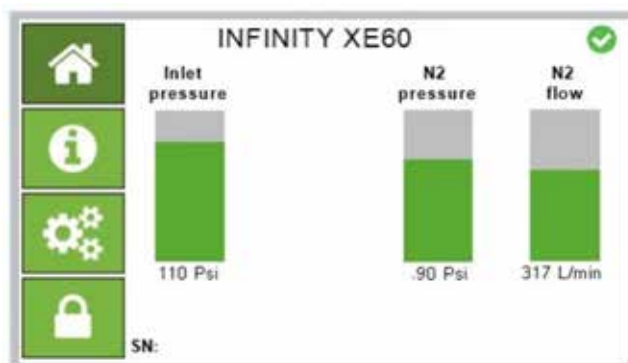

This shows live system pressures.

## Information Screen

The toggle arrows allow the user to view the two following information screens.



The initial information screen indicates the total number of membranes in the system and which membranes are currently activated. The above screen shows a four membrane system (XE6040) and highlights the activated membranes with a green box. This screen will also indicate the maximum flow of nitrogen that can be taken whilst achieving the set purity.



The second information screen shows details on service timeline and program versions.

## Settings Screen

These screens allow the user to toggle between different flow and purity measurement units. These can be set to the users personal preference at any time.

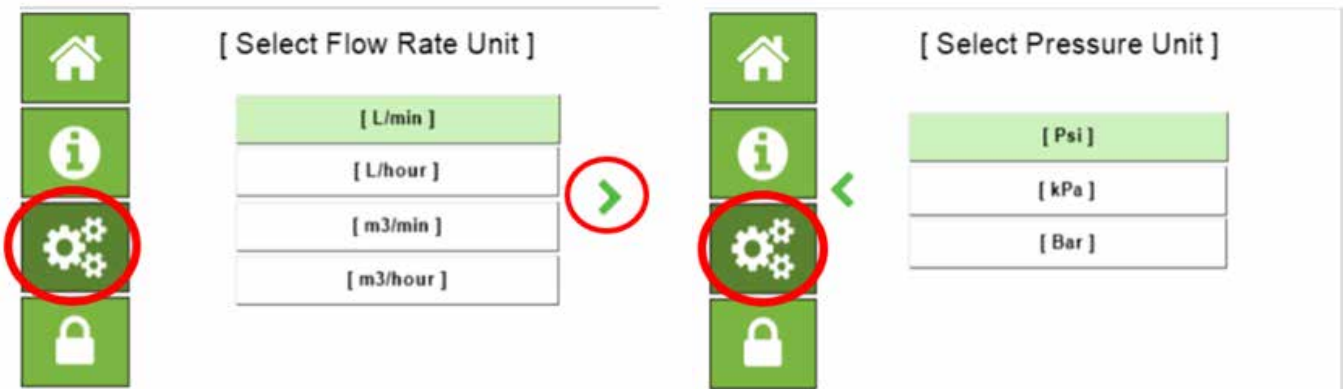

To change simply select the unit and then select confirm when prompted.

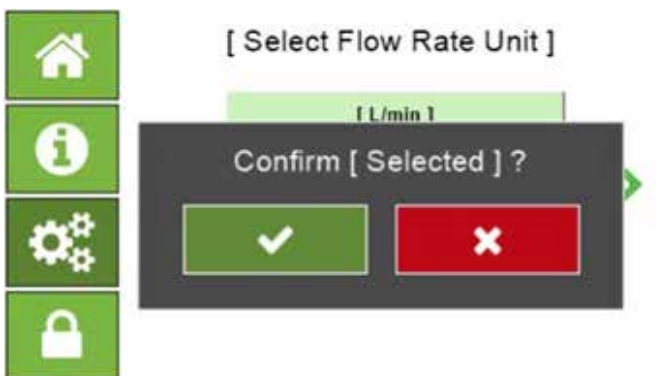

## System Icons

System icons will show in the top right of the screen and give indications on running conditions, faults or service alarms. A 'tick' icon in the top right indicates normal running conditions with no faults or service requirements.

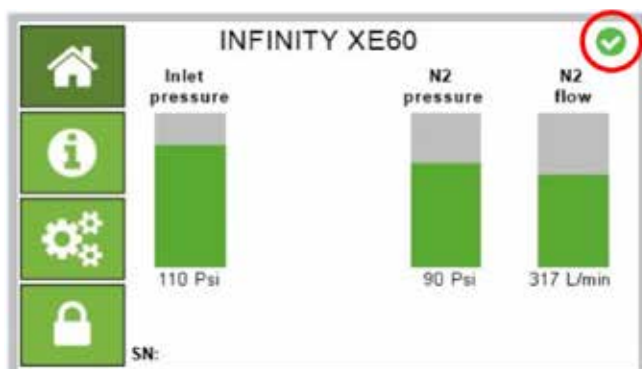

## 'Eco' mode

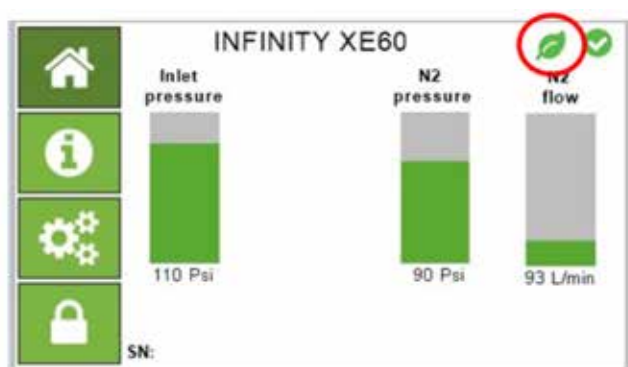

Depending on output flows the generator will shut down membranes in order to save house air. The generator constantly monitors the optimal number of membranes vs output flow and when the flow is lowered it will begin to close of the feed to certain membranes. When the demand is increased it will react by turning on any 'shut down' membranes. When a generator is running at purity with one or more membranes 'shut down', a green leaf icon will appear on the screen.



# Fault Codes

## XE60 Minor Fault Warning Codes

In the event of a minor fault with the generator, the HMI will display an amber warning signal along with a fault reference code.

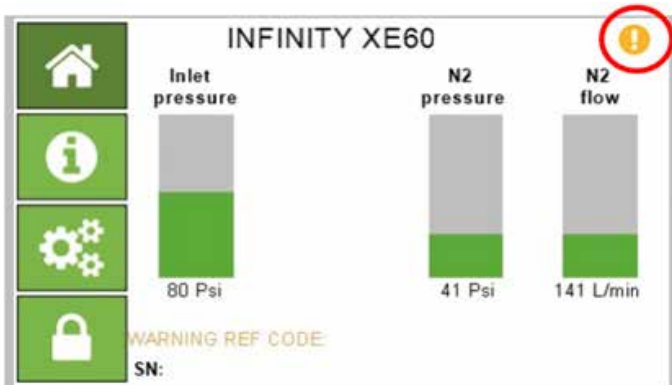

Toggle the warning indicator in the top right corner of the HMI to view warning code.



## Minor Fault codes

A list of minor fault codes for the XE60 is shown below;

- REF CODE 0100 = N2 Outlet Flow Rate High
- REF CODE 0502 = N2 Outlet Flow Rate High (For Specified Purity)
- REF CODE 0602 = Inlet Pressure Low
- REF CODE 0006 = Cell battery fault

## XE60 Major Fault Warning Codes

In the event of a major fault with the generator, the HMI will display a red warning signal along with a fault reference code.

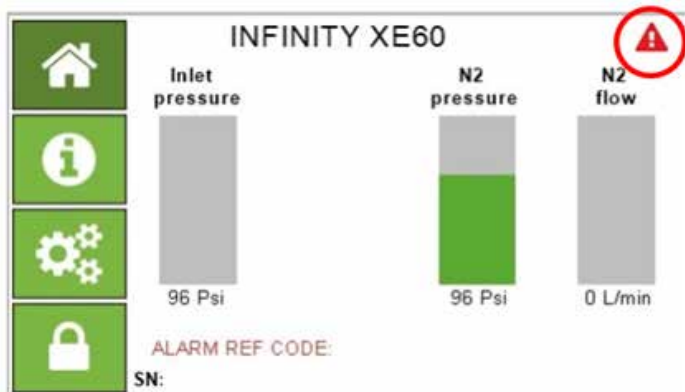

Toggle the warning indicator in the top right corner of the HMI to view warning code.



## Major Fault codes

A list of major fault codes for the XE60 is shown below;

- REF CODE 0001 = N2 Pressure Transducer Fault
- REF CODE 0002 = Air Pressure Transducer Fault (only if Dry Air option fitted)
- REF CODE 0003 = N2 Flow Transducer Fault
- REF CODE 0007 = Inlet Pressure Transducer Fault

# Service alarms

When a service is due, the HMI will show the following Icon on the screen;

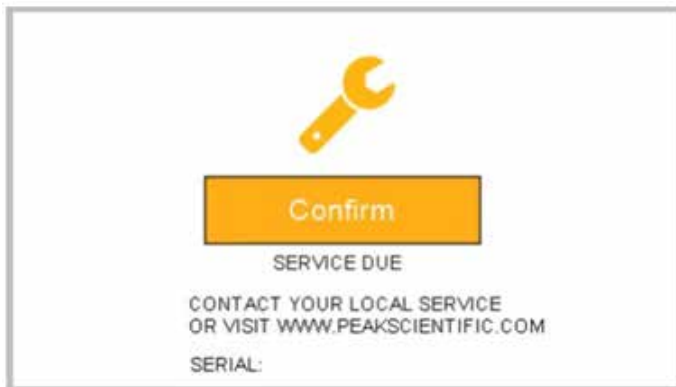
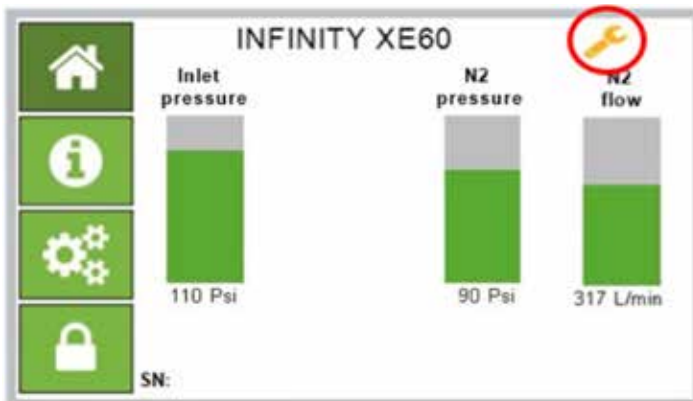

When a service is overdue, the HMI will show the following Icon on the screen;

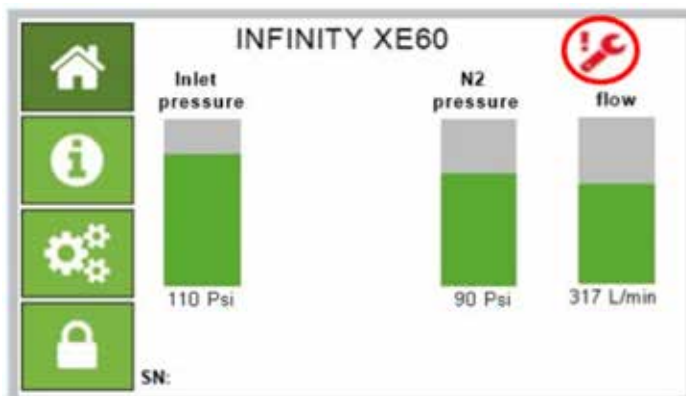

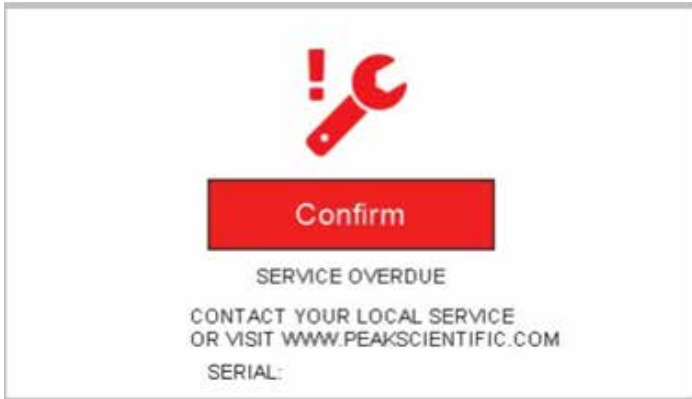

When a service is overdue, the HMI will show the following Icon on the screen;

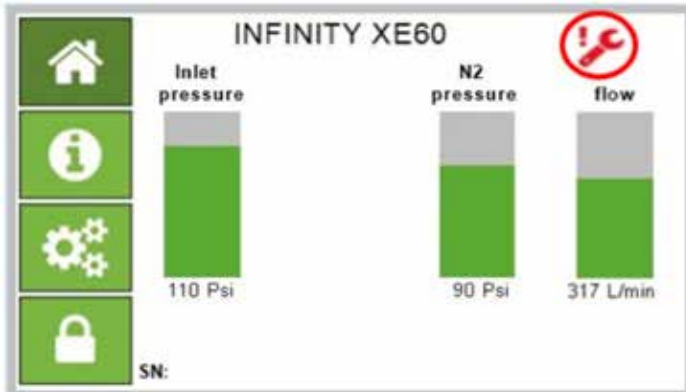

# Service Requirements

## Service Schedule

Purchase Interval	Component	Visit
12 Months	Infinity XE 60 Series Annual Maintenance Kit	<a href="http://www.peakscientific.com/ordering">www.peakscientific.com/ordering</a>
4 years	Infinity XE 60 Series 4-year Maintenance Kit	

# Optional Extras

## Air Dryer Optional Extra

If the generator has been fitted with the optional extra of an Air Dryer output, the HMI screens will have additional images;

### Home Screen

The Home Screen will include this additional bar graph to show Dry Air output pressure.

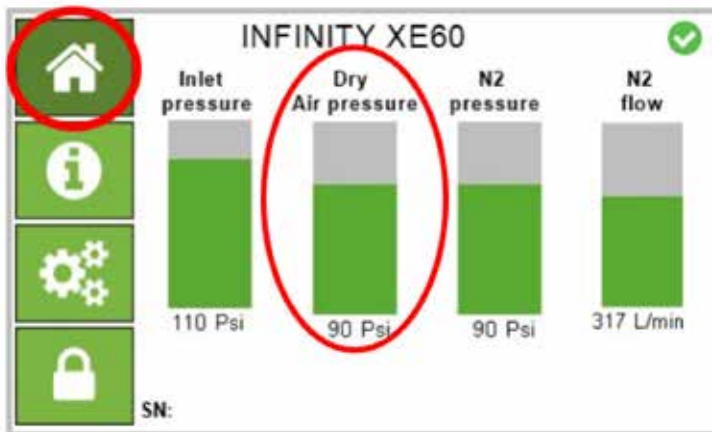

### Information Screen

The information screen will include the Dry Air membrane to the list of operational membranes. This will also indicate when the Dry Air Membrane is activated with a green box.

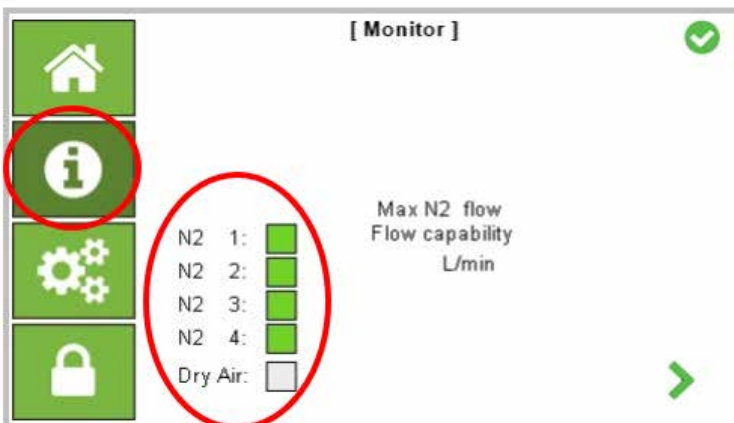

# Peak Protected

With Peak Scientific you invest in not only a product but peace of mind. With a network of certified Peak engineers stationed throughout the globe, Peak's rapid response team are never far away and our commitment is to keep your generator running day in, day out, protecting your laboratory workflow.

**[Peak Protected]** can provide...



**Installation**  
A dedicated Peak engineer will visit your lab to install and setup your generator



**Complete plan**  
Swift response by a Peak Service Engineer within 72 hours & planned preventative maintenance



**Premium Protected**  
Guaranteed rapid on-site response within 24 hours & planned preventative maintenance



**IQ/OQ**  
Certified assurance for applications requiring documented qualification

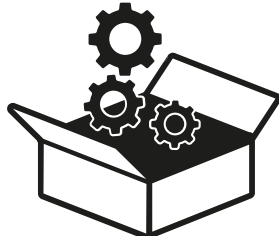

**Spares**  
Genuine Peak parts with express delivery, ensuring optimal performance and lifetime



**Technical Support Hotline**  
Around the clock support by phone or online with our global technical helpdesk

To find out more about protecting your investment visit: [www.peakscientific.com/protected](http://www.peakscientific.com/protected)

## Cleaning

Clean the outside of the generator only using warm soapy water and a clean damp cloth. Ensure all excess fluid is thoroughly removed from the cloth prior to use.



Cleaning should only be undertaken with the power switched off and the power cord removed from the rear of the generator.



Under no circumstances should any solvents or abrasive cleaning solutions be used as these can contain fumes that could be harmful to the generator.



Care should be taken with Leak Detections Liquids.

## Safely Isolated Condition

The unit is in a safely isolated condition when it is disconnected from its application and fully de-pressurised. Directions for isolating the Generator are shown below.



Failure to place the Generator in a safely isolated condition when instructed to do so may lead to personal injury or injury to others and even death.

1. Switch generator off.
2. Disconnect from air supply.
3. Ensure the output pressure gauge reads zero. (If gauge does not fall to zero, open the manual ball valve at the outlet port, to allow trapped gas to escape.)
4. Disconnect from the application.



## Safe State After Repair

To guarantee the generator is in a safe state after a repair, please ensure the following conditions are met;

- All earth leads have been reconnected.  
Earth leads should be connected to the earth tabs located on the door panels, as shown below.
- The electricity cable has been correctly refitted.  
The mains cable should be plugged into the IEC power inlet located on the rear panel of the generator. **This unit is classified as SAFETY CLASS 1. THIS UNIT MUST BE EARTHED.**



# Troubleshooting

Problem	Possible Solution
<p>The Generator will not switch on and the power switch does not illuminate.</p>	<ul style="list-style-type: none"> <li>• Ensure power cord is plugged into the Generator and that the power socket is turned on.</li> <li>• Check the fuse in the power cord plug.</li> <li>• Contact your service provider.</li> </ul> 
<p>The Generator will not switch on but the power switch is illuminated.</p>	<ul style="list-style-type: none"> <li>• Disconnect power cord from the rear of the Generator. Open the right hand panel are check that the circuit breaker is turned on (switch in the up position). Reconnect power cord.</li> <li>• Contact your service provider.</li> </ul> 
<p>The output pressure has dropped below its original set point.</p>	<ul style="list-style-type: none"> <li>• Check the pressure regulator(s) inside the unit has / have not been adjusted.</li> <li>• Check the HMI for a low pressure warning</li> <li>• If so, check your air supply does not have a pressure drop over the length of tubing and has no leaks.</li> <li>• Contact your service provider.</li> </ul>

# Go Online or Complete and Return

We know that registering any of your recently purchased products is not the first thing on your mind- but it is very important to both of us. Not all warranties are alike and Peak Scientific stand out against other gas suppliers as we offer a comprehensive, quick response, on-site warranty. This means that in the very unlikely case that your gas generator develops a fault we have rapid support teams on-hand around the world who are able to come to your lab and get you back up and running in no time.

Register for your **comprehensive 12 month on-site warranty** with ease online at [www.peakscientific.com/protected](http://www.peakscientific.com/protected).

Alternatively, you can send the completed form to Peak Scientific by post or email at [warranty@peakscientific.com](mailto:warranty@peakscientific.com).

**Go Online or Complete and Return**

You can register for your FREE 12 month Warranty with ease online at [www.peakscientific.com/protected](http://www.peakscientific.com/protected).

Alternatively, you can send the completed form to Peak Scientific by post or email at [warranty@peakscientific.com](mailto:warranty@peakscientific.com).

Product Warranty Registration			
Contact name			
Email address			
Company			
Address			
City/town			
Postcode			
Country			
Telephone			
Generator serial #			
Model type			
Installation date			
Do you still use an alternative gas solution i.e. cylinders or bulk liquid?	Yes	No	
What gas requirements do you have in your lab?	Hydrogen	Nitrogen	Zero Air

**Extend your cover with**

Peak Scientific offer comprehensive gas generator after sales support packages. Peak [Protected] aftercare support can guarantee an on-site response within 72 hours\*, genuine parts from our ISO9001 approved factory and a 95% first-time fix rate. See our enclosed Peak [Protected] leaflet for further information.

**Important!**

You have 1 month to register your Peak Scientific product from the date of installation. Once registered the warranty will be honoured for a period of 12 months. If you wish to defer the installation of your generator, you must notify Peak Scientific immediately by emailing [warranty@peakscientific.com](mailto:warranty@peakscientific.com). For generators that remain unregistered after 1 month from the shipment date, the warranty will be considered active from the date of factory dispatch.

\* Complete Plan only

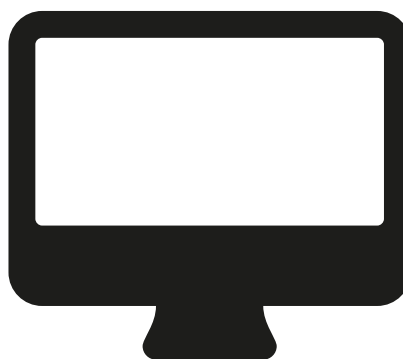

## Important!

You have **1 month to register** your Peak Scientific product from the date of installation. Once registered the warranty will be honoured for a period of 12 months. If you wish to defer the installation of your generator, you must notify Peak Scientific immediately by emailing [warranty@peakscientific.com](mailto:warranty@peakscientific.com). For generators that remain unregistered after 1 month from the shipment date, the warranty will be considered active from the date of factory dispatch.



# [**PEAK Protected**]<sup>TM</sup>

Peak Scientific has highly trained, fully certified Field Service Engineers located in over 20 countries across every continent around the world. This allows us to provide an industry-leading rapid response service to our customers. With [**Peak Protected**], your laboratory's productivity becomes our top priority.

To discuss Peak Protected generator cover and payment options speak to your local Peak Representative or for further information contact: [protected@peakscientific.com](mailto:protected@peakscientific.com)

**Peak Scientific**  
Fountain Crescent  
Inchinnan Business Park  
Inchinnan  
PA4 9RE  
Scotland, UK

**Tel: +44 141 812 8100**  
**Fax: +44 141 812 8200**

For further information on any of our generator products please contact [marketing@peakscientific.com](mailto:marketing@peakscientific.com)

