

Infinity 1046

User Manual

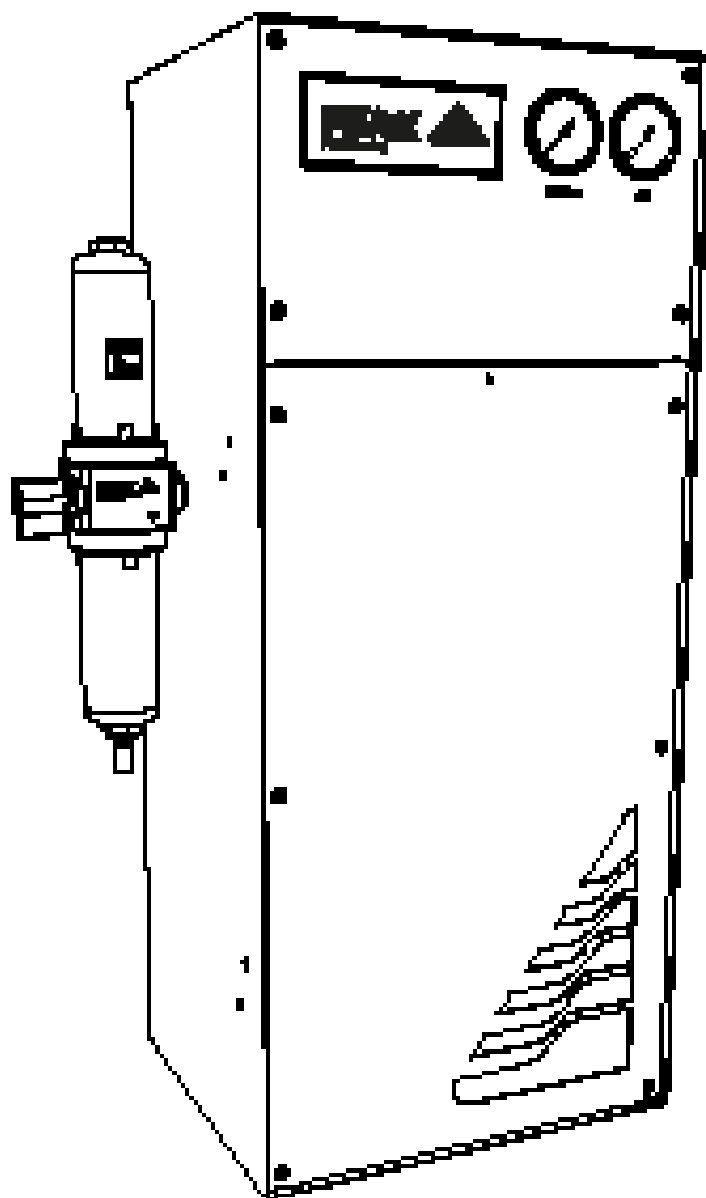

Contents

Change History	3
How to use this Manual	3
Introduction	4
Warranties and Liabilities	5
Warranty & Liability Coverage	5
Safety Notices	7
Certificate of Compliance	8
Technical Specification	9
Unpacking	10
Fittings Kit Contents	11
Installation	12
Generator Overview	13
Air Connection	14
Commissioning	15
Service Requirements	16
Peak Protected	17
Cleaning	18
Safely Isolated Condition	18
Troubleshooting	19
Notes	21

Change History

Rev	Comment	Name	Date
1	Initial Release	L. Couttie	31/08/2018
2	Inlet Conditions Update	L. Couttie	24/10/2018
3	Technical Specs Update	L. Couttie	11/12/2018
4	Declarations	D.Lai	12/10/2021

How to use this Manual

This manual is intended for end users and has been written as a reference document where you can skip to the relevant information.

Users can refer to the contents page to find the relevant information.

Please review each of the following sections carefully.

Thank you for selecting Peak Scientific to meet your gas generation needs, and should you require any further assistance or support please do not hesitate to contact Peak Scientific or the Peak Partner from which you purchased your generator.

Introduction

Generating up to 20 L/min nitrogen and 70 L/min dry air, the Infinity 1046 has been specifically designed to support the Perkin Elmer QSight Triple Quad, whether single/dual source configuration.

The Infinity Series are compressor-free gas generators which require a clean source of in-house air to operate effectively. With very few moving parts, these generators are effectively silent in operation and need only minimal care to ensure continued high performance and extended product life.

Warranties and Liabilities

Warranty & Liability Coverage

1. Peak warrants that, subject to the provisions in this statement, purchased Peak generators, whether purchased directly from Peak or indirectly via an approved, certified and trained distributor or partner (referred to hereafter as a "Peak Partner") will comply in all material respects with any specifications referred to in your customer order confirmation and, subject to installation and operational guidelines being followed as described in applicable product manuals, shall be free from any defects in quality of materials or workmanship for a period of one year from the date of installation, provided this takes place within 3 months of factory dispatch.
2. Where the purchased generator is from the Precision Hydrogen series, Peak further warrants that, subject to installation and operational guidelines being followed as described in applicable product manuals, the hydrogen cell shall be free from any defects in quality of materials or workmanship for a total period of three years (inclusive of warranty period specified in clause 1) from date of installation, provided this takes place within 3 months of factory dispatch.
3. Where the purchased generator is from the i-Flow 6000 series, Peak further warrants that, subject to installation and operational guidelines being followed as described in applicable product manuals, the generator shall be free from any defects in quality of materials or workmanship for a total period of two years (inclusive of warranty period specified in clause 1) from the date of installation, provided this takes place within 3 months of factory dispatch and the following provisions have also been met:
 - a. you must purchase a service plan, ensuring the generator is serviced by Peak or a Peak Partner on or before the end of the first 12 months of your ownership, and serviced at least once during each subsequent 12 month period thereafter;
 - b. the generator (and any associated equipment) must have been commissioned by Peak or a Peak Partner;
 - c. the feed air or inlet air supply to the generator must comply with ISO 8573-1:2010 Class 1.4.1 at all times;
 - d. your air compressor, dryer, filtration and oil removal systems must be deemed suitable for use by Peak or a Peak Partner, and must be changed and serviced regularly, in line with the equipment manufacturer's recommended guidelines; and
 - e. any generator failure or fault that is deemed to have been caused by the failure of any upstream equipment, component, part or system (such as air compressor, air treatment or filtration) will be excluded from the warranty described herein.
4. Peak also warrants that any replacement parts whether purchased (directly from Peak, or via a Peak Partner) or supplied as part of any remedial action undertaken in line with the provisions of clauses 12 and 13, shall be free from any defects in quality of materials or workmanship for a period of 180 days from the date of factory dispatch, provided its installation is performed by Peak or a Peak Partner.
5. This warranty does not exclude Peak's liability in respect of any claim for death or personal injury to any person, in so far as such can be attributed to negligence or breach of duty of care directly resulting from failure of Peak to comply with the provisions in clauses 1, 2, 3 & 4.

Exclusions & Limitations

6. This warranty does not cover:
 - a. damage, deterioration or malfunction resulting from an alteration or modification to a generator which has not been carried out by Peak or a Peak Partner;
 - b. damage, deterioration or malfunction resulting from what Peak reasonably believes to be abuse, or misuse of a generator by you or any third party;
 - c. liability for accident or neglect (other than pursuant to clause 5);
 - d. maintenance or repairs which have not been carried out by Peak or a Peak Partner;
 - e. operation of a generator or exposure of a generator to environmental conditions that fall out-with operational guidelines as specified in the applicable product user manual; and
 - f. lightning, power surges or any other acts of God or nature.
7. This warranty is non-transferrable. Only the original owner of the generator may benefit from the terms within this statement.

8. Peak shall not be liable in respect of any claim made for costs, damages, losses or expenses (whether consequential, direct, indirect or otherwise) or in any respect howsoever arising including, but not limited to, liability from accident or negligence (other than pursuant to clause 5) that may be suffered by you or any third party.
9. No person or entity is authorised to change the terms and conditions outlined in this warranty statement in any respect, or to create any additional obligations or liabilities for any party involved.
10. This warranty statement supersedes any and all prior warranty agreements between the parties and constitutes the complete, final and exclusive understanding of the parties with respect to the subject matter. All prior negotiations, representations, or promises, whether oral or written, of either party shall be deemed to have been merged herein.
11. If any part of this warranty statement is invalidated, for whatever reason, such part will be deleted and the rest shall remain unaffected, continuing to be in full force and effect.

Delivery of Warranty Service



12. Subject to clause 13, and:
 - a. Peak being notified by you, within the duration of the applicable warranty period, of any defect that you think is subject to any warranty valid under clauses 1, 2, 3 or 4; and
 - b. Peak being permitted to inspect the generators, parts and their installation (along with any relevant packaging)
Peak shall at its option repair or replace defective generators or parts (including, if necessary, any moving parts and irrespective of runtime). No additional charges will apply, for parts or delivery and, where applicable, labour or travel. Peak will endeavour to deliver this service within 3 working days of your notification.
13. Where, in Peak's reasonable opinion, a defect is subject to an exclusion described in clause 6, Peak reserves the right to charge for parts or delivery and, where applicable, you may also be charged by Peak for call out, labour or travel in respect of any repair or replacement which you authorize Peak to carry out.

Safety Notices

Peak Scientific Instruments cannot anticipate every possible circumstance which may represent a potential hazard. The warnings detailed within this manual refer to the most likely potential hazards, but by definition cannot be all inclusive. If the user employs an operating procedure, item of equipment or a method of working which is not specifically recommended by Peak Scientific, the user must ensure that the equipment will not be damaged or become hazardous to persons or property.

Symbols

This manual uses the following symbols to highlight specific areas important to the safe and proper use of the generator.

 WARNING	A WARNING notice denotes a hazard. It calls attention to an operating procedure, process or similar, which if not correctly performed or adhered to, could cause personal injury or in the worst case death. Do not proceed beyond a WARNING notice until the indicated conditions are fully understood or met.
 CAUTION	A CAUTION notice denotes a hazard. It calls attention to an operating procedure, process or similar, which if not correctly performed or adhered to, could cause damage to the generator or the application. Do not proceed beyond a CAUTION notice until the indicated conditions are fully understood or met.
	Caution, risk of electric shock. Ensure power to the generator has been removed before proceeding.

Safety Notice to Users



These instructions must be read thoroughly and understood before installation and operation of your Peak Generator. Use of the generator in a manner not specified by Peak Scientific MAY impair the SAFETY provided by the equipment.



When handling, operating or carrying out any maintenance, personnel must employ safe engineering practices and observe all relevant local health and safety requirements and regulations. The attention of UK users is drawn to the Health and Safety at Work Act 1974, and the Institute of Electrical Engineers regulations.



If the equipment is used in a manner not specified by the manufacturer, the protection provided by the equipment maybe impaired.

UK Declaration of Conformity

We Peak Scientific Instruments Ltd.
Of Fountain Crescent, Inchinnan, Renfrewshire, PA4 9RE

Hereby declare that, this declaration of conformity is issued under the sole responsibility of the manufacturer.

Equipment: Nitrogen & Air Generator
Models: Infinity 1046

To which this declaration relates, is in conformity with the following applicable UK Statutory Instruments, Standards and other normative requirements.

- **The Electrical Equipment (Safety) Regulations 2016 (SI 2016 / 1101) as amended.**
BS61010-1:2010 Safety Requirements for Electrical Equipment for Measurement Control and Laboratory Use.
- **The Electromagnetic Compatibility Regulations 2016 (SI 2016 / 1091) as amended.**
BS61326-1:2013 Electrical Equipment for Measurement , Control and Laboratory Use - EMC Requirements.
- **The Restriction of the Use of Certain Hazardous Substances in Electrical and Electronic Equipment Regulations 2012 (SI 2012 / 3032) as amended.**

Signed for and on behalf of Peak Scientific by

Signed: 

Name: Fraser Dunn

Position: Design Engineering Manager
Peak Scientific Instruments Ltd,
Inchinnan, Renfrew, Scotland, PA4 9RE, UK.

Date: 10th August 2021



WEEE Compliance Statement

The Waste Electrical and Electronic Equipment (WEEE) Regulations SI 2013 No 3113 and or the Waste Electrical and Electronic Equipment (WEEE) Directive 2012/19/EU apply to all electrical and electronic equipment placed on the market in the UK and EU covered by the scope of regulations which can be found in the Government Guidance Notes (PDF) produced by the Department for Business Innovation and skills for the UK and here for Europe.

All PEAK products that are subject to the WEEE directive are compliant with the WEEE marking requirement. Such products are marked with the “crossed-out wheellie bin” symbol (shown below) in accordance with European standard EN50419. All old electrical equipment can be recycled. Please do not dispose of any electrical equipment (including those marked with this symbol) in general rubbish bins. Please contact your dealer or distributor for clarity.



Technical Specification

Infinity 1046

Environment

	Infinity 1046
Minimum Operating Ambient Temperature	5°C (41°F)
Maximum Operating Ambient Temperature	30°C (86°F)
Maximum Relative Humidity	70% Non-Condensing

Inlet Conditions

Minimum Air Inlet Pressure	8.3 bar (120 psi)
Maximum Air Inlet Pressure	10 bar (145 psi)
Minimum Air Inlet Flow	180 L/min
Minimum Air Quality	ISO8573 - 1:2010 Class 1.4.1

Generator Outlets

Maximum Pressure Drop (Inlet-Outlet)	8 psi
Maximum Outlet Flow (Nitrogen)	20 L/min 0.71 cfm
Maximum Outlet Flow (Dry Air)	70 L/min
Max Gas Outlet Pressure (Nitrogen)	80 psi
Max Gas Outlet Pressure (Dry Air)	110 psi
Start-Up Time	60 minutes
Particles	<0.01µm
Pressure Gauges	2

General

Dimensions WxDxH	730 x 421.6 x 250 mm (28.8 x 16.6 x 9.9"
Generator Weight Kg (lbs)	23 kg (50.8 lb)
Shipping Weight Kg (lbs)	25 kg (55.2 lb)

Unpacking

Although Peak Scientific takes every precaution with safe transit and packaging, it is advisable to fully inspect the unit for any sign of transit damage.

Check 'SHOCKWATCH' and 'TIP-N-TELL' labels for signs of rough handling prior to unpacking

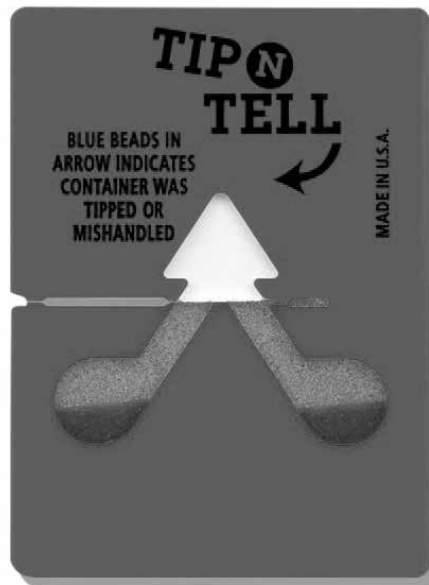

Any damage should be reported immediately to the carrier and Peak Scientific or the Peak Partner from where the unit was purchased.

Follow the unpacking instructions posted on the side of the crate. It will require two people to remove the unit from the shipping crate and to manoeuvre the generator to the desired location.

Please save the product packaging for storage or future shipment of the generator.

Note: Included with the generator is a "Fittings Kit" containing mains power leads for UK, EU & US and also all the required fittings and warranty registration card. Be careful not to discard these with the packaging.

Fittings Kit Contents

Supplied in the Fittings Kit are all the fittings required to connect the generator to the application. The contents of the Fittings Kit are as follows:

- | | |
|---------------------------------------|------|
| 1. 1/4" Compression Fittings | x 2 |
| 2. 1/4" Teflon Tubing | x 8m |
| 3. Screw N8 x 1 1/4 Supa Counter Sunk | x 3 |
| 4. Raw-Plug for N8 Screw (521-3087) | x 3 |
| 5. Installation Guide-Infinity 1046 | x 1 |
| 6. User Manual CD- Infinity 1046 | x 1 |

All of the generators output ports are located on the output panel at the rear of the unit.

Installation

Generator Environment

The generator is designed for indoor use only. It should be installed adjacent to the application(s) it is supplying. If this is not convenient then the unit can be sited elsewhere, however, consideration should be made of the lengths of pipe runs as pressure drops can result from extended runs of pipe.

Performance of the generator is affected by ambient conditions. Note should also be taken to the proximity of Air Conditioning outlets. These can sometimes give rise to “pockets” of air with high relative humidity. Operation of the unit within such a pocket could adversely affect its performance. Consideration should also be given to the air flow around the unit. It is recommended that an air gap of 75mm (3”) should be maintained down both sides and at the rear of the unit. Please refer to the drawing below for the general dimensions of the unit.

Minimum Operating Ambient Temperature: 5 °C (41 °F)

Maximum Operating Ambient Temperature: 30 °C (86 °F)

Generator Overview

General Dimensions

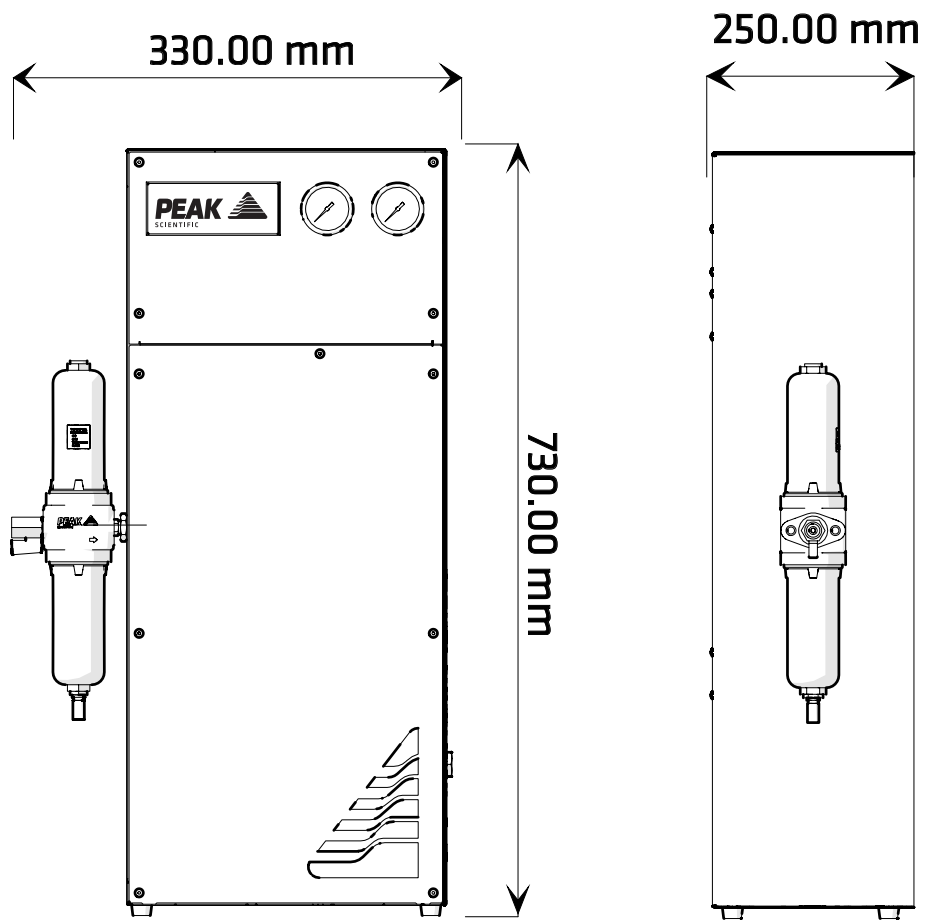

The generator must always be placed on a flat, level surface. Failure to do so will affect the performance of the generator.

Air Connection

Infinity 1046 Generator should be connected to a clean, dry, OIL - FREE source of compressed air. A minimum inlet pressure of 120 psig (8.3 barg) is required. Any doubts as to the suitability of your compressed air supply should be referred to Peak Scientific or any of their authorised partners.

The generator has a Breathing Air Filter with $\frac{1}{4}$ " BSPT connection to the left side of the unit. The Compressed Air supply should be connected here. This filter will drain moisture and is equipped with an automatic drain. The drain should be led to a convenient place. There are 2-off $\frac{1}{4}$ " BSPT Female bulkhead connections to the right of the unit. Fittings are provided to connect these ports to the gas connections of the Mass Spectrometer.

LC/MS with 2-off Connections (e.g. LC-TQ)

Connect the 2-off gas ports at the right side of the generator to their respective ports on the Mass Spectrometer using the 2-off $\frac{1}{4}$ " BSPT x $\frac{1}{4}$ " Swagelok fittings. Use $\frac{1}{4}$ " tubing throughout.

Commissioning

With the Generator installed (as described earlier), connect compressed air to the unit and open the air supply to the Unit. Disconnect the Outlet connections to allow the generator to vent to atmosphere until the unit is stabilised. The Generator has been pre-set in the factory to give the specified output flow-rate and pressure in line with known requirements. Once the Membranes reach the design pressures the Generator will stabilise and produce Nitrogen. Maximum purity will be achieved after approximately 1 hour. The generator can then be re-connected to the application.

The design of the generator is such that it can deliver up to the supplies specified in the Pressure & Flow Settings table below. Should the demand for gasses be less than the rated output flow at any time, the demand will be determined by the consuming equipment. In circumstances of no demand, the Generator remains operational and will provide Nitrogen immediately as demand resumes.

Service Requirements

Service Schedule

Purchase Interval	Component	Visit
12 Months	Infinity 1045/1046 Annual Maintenance Kit	www.peakscientific.com/ordering

Peak Protected

With Peak Scientific you invest in not only a product but peace of mind. With a network of certified Peak engineers stationed throughout the globe, Peak's rapid response team are never far away and our commitment is to keep your generator running day in, day out, protecting your laboratory workflow.

[Peak Protected] can provide...



Installation
A dedicated Peak engineer will visit your lab to install and setup your generator



Complete plan
Swift response by a Peak Service Engineer within 72 hours & planned preventative maintenance



Premium Protected
Guaranteed rapid on-site response within 24 hours & planned preventative maintenance



IQ/OQ
Certified assurance for applications requiring documented qualification

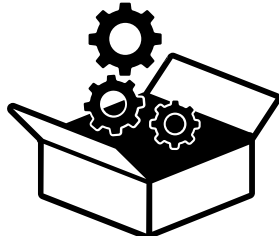

Spares
Genuine Peak parts with express delivery, ensuring optimal performance and lifetime



Technical Support Hotline
Around the clock support by phone or online with our global technical helpdesk

To find out more about protecting your investment visit: www.peakscientific.com/protected

Cleaning

Clean the outside of the generator only using warm soapy water and a clean damp cloth. Ensure all excess fluid is thoroughly removed from the cloth prior to use.



Under no circumstances should any solvents or abrasive cleaning solutions be used as these can contain fumes that could be harmful to the generator.



Care should be taken with Leak Detections Liquids.

Safely Isolated Condition

The unit is in a safely isolated condition when it is disconnected from its application and fully de-pressurised. Directions for isolating the Generator are shown below.



Failure to place the Generator in a safely isolated condition when instructed to do so may lead to personal injury or injury to others and even death.

1. Disconnect from air supply.
2. Ensure the output pressure gauge reads zero. (If gauge does not fall to zero, open the manual ball valve at the outlet port, to allow trapped gas to escape.)
3. Disconnect from the application.

Troubleshooting

Problem	Possible Solution
The output pressure has dropped below its original set point.	<ul style="list-style-type: none">• Check the pressure regulator at the back of the unit has not been adjusted.• Check to see if the inlet pressure gauge has dropped below the set air supply pressure.• If so, check your air supply does not have a pressure drop over the length of tubing and has no leaks.• Contact your service provider.

Go Online or Complete and Return

We know that registering any of your recently purchased products is not the first thing on your mind- but it is very important to both of us. Not all warranties are alike and Peak Scientific stand out against other gas suppliers as we offer a comprehensive, quick response, on-site warranty. This means that in the very unlikely case that your gas generator develops a fault we have rapid support teams on-hand around the world who are able to come to your lab and get you back up and running in no time.

Register for your **comprehensive 12 month on-site warranty** with ease online at www.peakscientific.com/protected.

Alternatively, you can send the completed form to Peak Scientific by post or email at warranty@peakscientific.com.

Go Online or Complete and Return

You can register for your **FREE 12 month Warranty** with ease online at www.peakscientific.com/protected.

Alternatively, you can send the completed form to Peak Scientific by post or email at warranty@peakscientific.com.

Product Warranty Registration			
Contact name			
Email address			
Company			
Address			
City/town			
Postcode			
Country			
Telephone			
Generator serial #			
Model type			
Installation date			
Do you still use an alternative gas solution i.e. cylinders or bulk liquid?	Yes	No	
What gas requirements do you have in your lab?	Hydrogen	Nitrogen	Zero Air

Extend your cover with

Peak Scientific offer comprehensive gas generator after sales support packages. Peak [Protected] aftercare support can guarantee an on-site response within 72 hours*, genuine parts from our ISO9001 approved factory and a 95% first-time fix rate. See our enclosed Peak [Protected] leaflet for further information.

Important!

You have 1 month to register your Peak Scientific product from the date of installation. Once registered the warranty will be honoured for a period of 12 months. If you wish to defer the installation of your generator, you must notify Peak Scientific immediately by emailing warranty@peakscientific.com. For generators that remain unregistered after 1 month from the shipment date, the warranty will be considered active from the date of factory dispatch.

* Complete Plan only

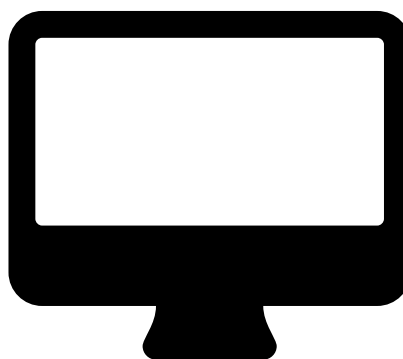

Important!

You have **1 month to register** your Peak Scientific product from the date of installation. Once registered the warranty will be honoured for a period of 12 months. If you wish to defer the installation of your generator, you must notify Peak Scientific immediately by emailing warranty@peakscientific.com. For generators that remain unregistered after 1 month from the shipment date, the warranty will be considered active from the date of factory dispatch.

Notes

[**PEAK Protected**]TM

Peak Scientific gas generators define the benchmark in reliability, convenience and performance in laboratories around the world, and come backed by a 12 month warranty. Beyond this period however you can ensure that your investment continues to be [Protected] by our comprehensive generator care cover.

Our world-class aftercare support packages deliver a program of scheduled preventative maintenance whilst giving you the reassurance of instant access to worldwide technical support and priority on-site response in the untimely event of a breakdown.

Peak Scientific

Fountain Crescent
Inchinnan Business Park
Inchinnan
PA4 9RE
Scotland, UK

Tel: +44 141 812 8100

Fax: +44 141 812 8200

For further information on any of our generator products please contact marketing@peakscientific.com

