

Precision Hydrogen 1200cc (All Models)

User Manual

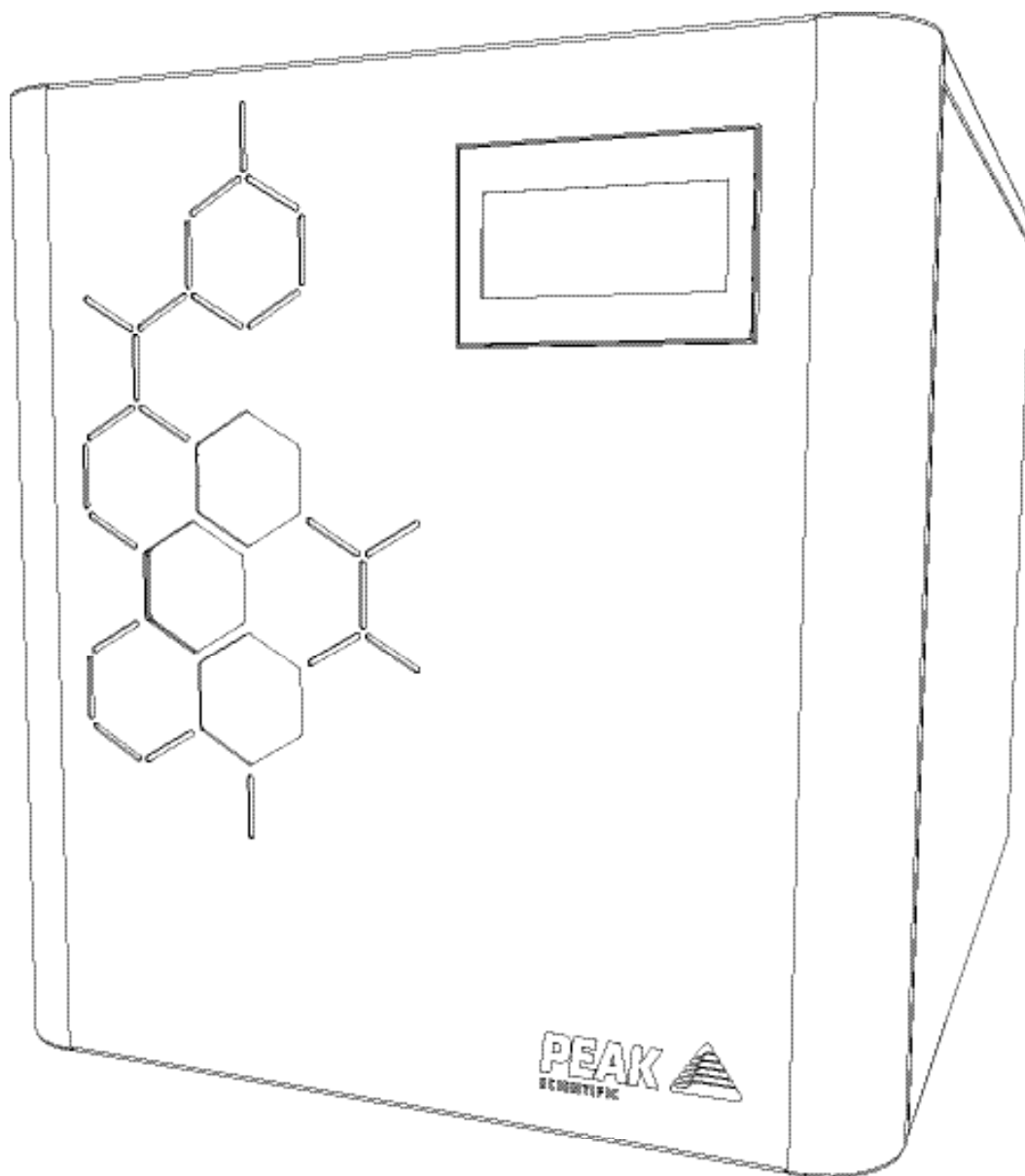

PEAK 
SCIENTIFIC

Contents

Change History	3
How to use this Manual	3
Introduction	4
Health and Safety Data	5
Deioniser Resin	5
Warranties and Liabilities	7
Safety Notices	8
Symbols	8
Safety Notice to Users	8
Attention - Important Notice to All Users	9
EU Declaration of Conformity	10
UK Declaration of Conformity	11
WEEE Compliance Statement	12
CSA Compliance Statement	13
European Union (EU) and United Kingdom (UK) Class A Compliance statement	14
Industry Canada Class A emission compliance statement	14
Korea Communications Commission (KCC) statement	14
Technical Specification	15
Precision Hydrogen	15
Principle of Operation	16
General Safety	17
Generator Safety Features	18
Unpacking	19
Fittings Kit Contents	20
Unpacking Instructions	20
Transit Plug Removal	21
Installation	22
Location	22
Generator Overview	23
General Dimensions	23
Unit Controls	24
Rear Connections	24
Tubing	25
H ₂ Ventilation	25
Water Quality	26
Automatic Filling	26
Draining the Water Tank	29
Water Usage	30
Electrical Connection	31
Start-up Sequence	32
Liquid Leak Detectors	32
Gas Traps	32
H ₂ Detector Option	33
Expanding Capacity	34
Rear Connections	34
Switching the Unit Off	35
Cleaning	35
Deioniser Column Replacement	36
Precision Hydrogen 1200cc	36
Service Requirements	38
Service Schedule	38
Troubleshooting	39

Change History

Rev	Comment	Name	Date
1	Initial Release	Liam Couttie	09/02/2018
2	Transit Plugs Added	Liam Couttie	22/03/2018
3	Trace Model Information Added	Liam Couttie	23/07/2018
4	Cell Warranty Update	Liam Couttie	24/09/2018
5	Warranty Information Update	Liam Couttie	26/11/2018
6	Accreditation Update	Liam Couttie	05/11/2019
7	Purity Update	Liam Couttie	25/05/2021
8	Declarations Update	Cleo Denholm	31/08/2021
9	Fittings Kit Update	Liam Couttie	23/05/2022
10	Update	Liam Couttie	26/06/2023
11	Draining the Water Tank	Liam Couttie	26/07/2023
12	Declarations Update	Liam Couttie	02/10/2023
13	Specs Update	D Lai	18/01/2024

How to use this Manual

This manual is intended for end users and has been written so that it can either be read as a step by step guide to installation and usage or as a reference document where you can skip to the relevant information.

Users can refer to the contents page to find the relevant information.

Please review each of the following sections carefully.

Thank you for selecting Peak Scientific to meet your Gas Generation needs, and should you require any further assistance or support please do not hesitate to contact Peak Scientific or Peak Partner from which you purchased your Generator.

Introduction

The Precision Hydrogen 1200cc has been developed to cater for the requirements of GC instruments.

This generator provides a source of high purity hydrogen gas, suitable for carrier gas if used in conjunction with carrier gas traps and detector gas.

Other features include:

- Easy to use touch screen interface
- Status indicative lighting feature
- Stackable with other Precision units
- Purities of up to 99.9995% (Standard) and 99.99999% (Trace).

The Precision Hydrogen 1200cc is based on proven technology, it produces hydrogen by electrolysis using a Proton Exchange Membrane (PEM) cell. Moisture removal is achieved by a maintenance free Pressure Swing Adsorption (PSA) dryer.

To ensure this generator model meets our high expectations with regards to reliability and performance, we have tested this model extensively at our manufacturing plant and in the field to ensure reliability and longevity of the system.

Health and Safety Data

Deioniser Resin

This sheet to be retained by the 'Health & Safety Officer'

The recipient of this Health & Safety Data sheet is required to ensure that all personnel handling, using or likely to come into contact with the material are made aware of the Health & Safety information contained herein.

General Description

Bag containing ion exchange resin. 60% Cation and 40% Anion by mass.

Chemical Components

Polystyrene divinylbenzene cation and ion exchange resin.

Form	Solid beads
Flash Point	N/A
Colour	Tan
Ignition Temperature	427 °C (Estimated)
Odour	None
Explosion Limits	N/A
Decomposition Temperature	Over 220 °C
Vapour Pressure @ 25 °C	17mm CFH @ 20 °C (Water)
Viscosity @ 25°C	N/A
Solubility in Water	Negligible
Specific Gravity @ 25°C	1.1-1.3
pH @ 25 °C	7-9.5 in aqueous slurry
Eye Protection	Safety Glasses (BS2092C)
Storage	Store in a cool place above 0 °C, out of direct sunlight
Fire & Explosion Hazards	Toxic combustion products may include sulphur dioxide and sulphur trioxide
Disposal	This product can be disposed as ordinary waste if local regulations permit

Emergency & First Aid Procedures

Spillages

Floor may be slippery. Use care to avoid falls. Wear protective glasses.

Sweep up and transfer to containers for recovery and disposal.

Extinguishing Media

Carbon Dioxide (CO₂), Water Fog and Dry Powder.

Fire Fighting and Protection

Wear HSE approved, pressure demand, self-contained breathing apparatus or

equivalent.

First Aid

Skin Contact

Wash effected areas with soap and water. Consult doctor if irritation persists.

Eye Contact

Product can cause severe eye irritation. Flush eyes with large amounts of water for at least 15 minutes. Consult a doctor if irritation persists.

Inhalation

This product should present no hazard if operated under normal conditions. If irritation persists, move patient to fresh air.

Ingestion

If resin has been confined to the mouth, administer 250 ml. of water as a mouthwash. Avoid swallowing. This product is considered non-hazardous if ingested in small amounts; however, it is advisable to seek medical advice.

Toxicological Data

No toxicity data available on this product

Occupation exposure limits

STEL/TLV = None established.

Incompatible Materials (to avoid hazardous reactions)

Avoid contact with concentrated nitric acid and any other strong oxidising agents at all times.

Warranties and Liabilities



1. The Company warrants that it has title to the Goods.
2. Subject to the provisions of this clause the Company warrants that the Goods shall comply in all material respects with any specification referred to in the Order Confirmation (as the same may be amended) and shall, subject thereto, be free from defects in material and workmanship for the lesser of a period of twelve months from the date of delivery or thirteen months from the date of dispatch from the factory.
3. Subject to the provisions of this clause the Company warrants that the Hydrogen Cell shall comply in all material respects with any specification referred to in the Order Confirmation (as the same may be amended) and shall, subject thereto, be free from defects in material and workmanship for the period of three years from the date of delivery.
4. Save as provided in this clause and except where the Goods are sold to a person dealing as a consumer (within the meaning of the Unfair Contract Terms Act 1977) all warranties, conditions or other terms implied by statute or common law are hereby expressly excluded save to the extent they may not be lawfully excluded. When the Goods are sold to a consumer within the meaning of the Unfair Contract Terms Act 1977 their statutory rights are not affected by the provisions of this clause.
5. In the event of the Customer making a claim in respect of any defect in terms of clause 2 hereof the Customer must.
 1. Reasonably satisfy the Company that the Goods have been properly installed, commissioned, stored, serviced and used and without prejudice to the generality of the foregoing that any defect is not the direct or indirect result of lack of repair and/or servicing, incorrect repair and/or servicing, use of wrong materials and/or incorrect spare parts.
 2. Allow the company to inspect the Goods and/or any installation and any relevant packaging as and when reasonably required by the Company.
6. Subject to the Company being notified of any defect as is referred to in sub-clause 2 hereof within a reasonable time of it becoming apparent and subject always to the terms of sub-clause 4 hereof, the Company shall, in its option, replace or repair the defective Goods or refund a proportionate part of the Price. The Company shall have no further liability to the Customer (save as mentioned in sub-clause 6 hereof).
7. The Company shall be liable to indemnify the Customer in respect of any claim for death or personal injury to any person in so far as such is attributable to the negligence or breach of duty of the Company or any failure by the Company to comply with the provisions of sub-clause 2 hereof.
8. Save as provided in sub-clause 2 hereof the Company shall not be liable in respect of any claim by the Customer for costs, damages, loss or expenses (whether direct, indirect, consequential or otherwise) or indemnity in any respect howsoever arising including, but not by way of limitation, liability arising in negligence (other than pursuant to clause 6 above) that may be suffered by the Customer or any third party.

Safety Notices

Peak Scientific Instruments cannot anticipate every possible circumstance which may represent a potential hazard. The warnings detailed within this manual refer to the most likely potential hazards, but by definition cannot be all inclusive. If the user employs an operating procedure, item of equipment or a method of working which is not specifically recommended by Peak Scientific, the user must ensure that the equipment will not be damaged or become hazardous to persons or property.

Symbols

This manual uses the following symbols to highlight specific areas important to the safe and proper use of the Generator

 WARNING	A WARNING notice denotes a hazard. It calls attention to an operating procedure, process or similar, which if not correctly performed or adhered to, could cause personal injury or in the worst case death. Do not proceed beyond a WARNING notice until the indicated conditions are fully understood or met.
 CAUTION	A CAUTION notice denotes a hazard. It calls attention to an operating procedure, process or similar, which if not correctly performed or adhered to, could cause damage to the generator or the application. Do not proceed beyond a CAUTION notice until the indicated conditions are fully understood or met.
	Caution, risk of electric shock. Ensure power to the generator has been removed before proceeding.

Safety Notice to Users



These instructions must be read thoroughly and understood before installation and operation of your Peak Precision Hydrogen Generator. Use of the generator in a manner not specified by Peak Scientific MAY impair the SAFETY provided by the equipment.



When handling, operating or carrying out any maintenance, personnel must employ safe engineering practices and observe all relevant local health and safety requirements and regulations. The attention of UK users is drawn to the Health and Safety at Work Act 1974, and the Institute of Electrical Engineers regulations.



If the equipment is used in a manner not specified by the manufacturer, the protection provided by the equipment maybe impaired.

Attention - Important Notice to All Users



These instructions must be read thoroughly, section by section and understood before installation and operation of your Peak Scientific Hydrogen Generator. Please follow the appropriate safety standards for handling hydrogen gas and other gases as determined by the laws and regulations of your country.

Please save the product packaging for storage or future shipment of the generator.

1. For your own personal safety and to prevent accidental damage to your generator please ensure that you read and understand our User Manual.
2. Do not store away the generator when not in operation . External water bottles must be made of a dark coloured material in order to prevent biological growth (available from Peak Scientific). It is recommended that you check the water quality weekly to prevent biological growth developing in the tank and tubing. Failure to do this will greatly reduce the life of the generator and render the 3 year cell warranty void.
3. Do not place the external water bottle above the height of the generator. The bottle may be placed at the same level or below the generator.
4. Use only high grade de-ionised water (1 μ S/cm or better). Failure to use the correct quality water will invalidate the cell and system warranty. Do not attempt to connect pressurised water to the generator.
5. Failure to maintain the Deioniser Cartridge as recommended will reduce the operational life of your generator and render its 3 year cell warranty void.
6. Do not attach any additional tanks or gas cylinders to your generator without first consulting Peak Scientific.
7. Ensure your entire installation, both pipe work and analysers, are completely gas tight. Even minor leaks will affect the operation of your generator and generally reduce its operational life.
8. Has your generator been correctly sized for your application? If in doubt, consult your dealer or Peak Scientific.
9. Ensure the ambient temperature inside your laboratory does not rise above 35°C/95°F. Extremes of operating temperature will reduce cell life.

EU Declaration of Conformity

We Peak Scientific Instruments Ltd.
Of Fountain Crescent, Inchinnan, Renfrewshire, PA4 9RE

Hereby declare that, this declaration of conformity is issued under the sole responsibility of the manufacturer.

Equipment Type: **Hydrogen Generator**
Model Designator: **Precision Hydrogen 1200cc (All Models)**

To which this declaration relates, is in conformity with the following applicable EU Directives, harmonized standards, and other normative requirements.

- **Low Voltage Directive 2014/35/EU**
EN 61010-1: 2010/ A1:2019 Safety Requirements for Electrical Equipment for Measurement, Control and Laboratory Use.
- **Electromagnetic Compatibility Directive 2014/30/EU**
EN 61326-1: 2013 Electrical Equipment for Measurement, Control and Laboratory Use - EMC Requirements. (Class A)
- **Restriction on the use of certain hazardous substances in electronic equipment (RoHS) Directive 2011/65/EU as amended by EU 2015/863.**

Signed for and on behalf of Peak Scientific by

Signed: 

Name: **Fraser Dunn**

Position: **Design Engineering Manager**
Peak Scientific Instruments Ltd,
Inchinnan, Renfrew, Scotland, PA4 9RE, UK.

Date: **24th February 2022**



UK Declaration of Conformity

We Peak Scientific Instruments Ltd.
Of Fountain Crescent, Inchinnan, Renfrewshire, PA4 9RE

Hereby declare that, this declaration of conformity is issued under the sole responsibility of the manufacturer.

Equipment Type: **Hydrogen Generator**
Model Designator: **Precision Hydrogen 1200cc (All Models)**

To which this declaration relates, is in conformity with the following applicable UK Statutory Instruments, Standards and other normative requirements.

- **The Electrical Equipment (Safety) Regulations 2016 (SI 2016 / 1101) as amended.**
BS61010-1:2010 / A1:2019 Safety Requirements for Electrical Equipment for Measurement Control and Laboratory Use.
- **The Electromagnetic Compatibility Regulations 2016 (SI 2016 / 1091) as amended.**
BS61326-1:2013 Electrical Equipment for Measurement , Control and Laboratory Use - EMC Requirements. (Class A)
- **The Restriction of the Use of Certain Hazardous Substances in Electrical and Electronic Equipment Regulations 2012 (SI 2012 / 3032) as amended.**

Signed for and on behalf of Peak Scientific by

Signed: 

Name: **Fraser Dunn**

Position: **Design Engineering Manager**
Peak Scientific Instruments Ltd,
Inchinnan, Renfrew, Scotland, PA4 9RE, UK.

Date: **24th February 2022**



WEEE Compliance Statement

The Waste Electrical and Electronic Equipment (WEEE) Regulations SI 2013 No 3113 and or the Waste Electrical and Electronic Equipment (WEEE) Directive 2012/19/EU apply to all electrical and electronic equipment placed on the market in the UK and EU covered by the scope of regulations which can be found in the Government Guidance Notes (PDF) produced by the Department for Business Innovation and skills for the UK and here for Europe.

All PEAK products that are subject to the WEEE directive are compliant with the WEEE marking requirement. Such products are marked with the “crossed-out wheellie bin” symbol (shown below) in accordance with European standard EN50419. All old electrical equipment can be recycled. Please do not dispose of any electrical equipment (including those marked with this symbol) in general rubbish bins. Please contact your dealer or distributor for clarity.



CSA Compliance Statement

CSA Group (Canadian Standards Authority) is a Nationally Recognised Testing Laboratory (NRTL), headquartered in Toronto Canada.

They are authorised to evaluate product to both their own and Underwriters Laboratory (UL) standards and certify the product to be in compliance to the relevant standards.

Peak products are certified to the current in force revision of the following standards in order to cover both Canadian and United States requirements for “Safety Requirements for Electrical Equipment for Measurement, Control and Laboratory use, Part 1: general Requirements”.

Canada: CAN/CSA C22.2 No 61010-1-12

United States: UL 61010-1

As a result the products covered by this statement are certified and listed by CSA accordingly and are entitled to carry the CSA mark with both Canadian and United States subscripts , as shown below on the product rating label.



EMC Class A Compliance Statements

European Union (EU) and United Kingdom (UK) Class A Compliance statement

This is a Class A product. In a domestic environment this product may cause radio interference in which case the user may be required to take adequate measures.

FCC Class A Compliance Statement

This equipment has been tested and found to comply with the limits for a Class A digital device, pursuant to part 15 of the FCC Rules. These limits are designed to provide reasonable protection against harmful interference when the equipment is operated in a commercial environment. This equipment generates, uses, and can radiate radio frequency energy and, if not installed and used in accordance with the instruction manual, may cause harmful interference to radio communications. Operation of this equipment in a residential area is likely to cause harmful interference in which case the user will be required to correct the interference at his own expense.



Industry Canada Class A emission compliance statement

This ISM device complies with Canadian ICES-001 (A).

Cet appareil ISM est conforme à la norme NMB-001 (A) du Canada.

Korea Communications Commission (KCC) statement

이 기기는 업무용(A급)으로 전자파적합기기로서 판매자 또는 사용자는 이 점을 주의하시기 바라며, 가정외의 지역에서 사용하는 것을 목적으로 합니다.

(This is electromagnetic wave compatibility equipment for business (Type A). Sellers and users need to pay attention to it. This is for any areas other than home.)

Technical Specification

Precision Hydrogen

Environment

	1200cc	1200cc Trace
Minimum Operating Ambient Temperature	10°C (50°F)	
Maximum Operating Ambient Temperature	35°C (95°F)	
Maximum Altitude	2000 m	
Maximum Relative Humidity	90% Non-Condensing	
Minimum Storage Temperature*	10°C (50°F)	
Maximum Storage Temperature*	25°C (77°F)	

Generator Outlets

Max Flow Rate**	1200 cc/min	
Purity	99.9995%	99.99999%
Gas outlet	1 x 1/8" Swagelok compression fitting	
Delivery pressure	0-100 psi (0-6.9 bar)	

Electrical Requirements

Voltage	100-230VAC	
Frequency	50/60 Hz	
Current	10 A Max	
Input Connection	C14 Connection	
Power Cord (Supplied)	C13 socket to local connection (10A minimum)	
Pollution Degree	2	
Insulation Category	I	

General

Generator Dimensions cm (W x D x H)	38.0 (14.9") x 54.0 (21.2") x 40.6 (15.9")	
Generator Weight	31.5Kg (69.5 lbs)	
Shipping Crate Dimensions cm (W x D x H)	54.0 (21.2") x 70.0 (27.5") x 49.0 (19.2")	
Shipping Weight	38 kg (83.8 lbs)	
Heat Output	1000 BTU / Hr	
Water Purity Requirement	<1.0μ Siemens/cm OR >1 Mohm-cm	

* When taken out of storage the Generator should be allowed to acclimatize at room temperature for a minimum of 3 hours before operation.

** All flow rates are stated in sccm at 273.15K and 1.01bar

Principle of Operation

The Peak Scientific hydrogen generator produces high purity hydrogen gas (H₂). Hydrogen does not occur naturally on earth and must be formed via the decomposition of other molecules, in this case via the splitting of water molecules into hydrogen and oxygen in a process known as electrolysis.

The state of the art in water electrolysis is the Proton Exchange Membrane (PEM) electrolyser. This technology was first described in the mid-1960s by General Electric as a method for producing electricity for the Gemini Space Program and later adapted for electrolysis. This process has been continually developed ever since. All Peak Scientific hydrogen generators utilise PEM technology .

The most important element of the generator is the electrolyser cell where the electrolysis reaction takes place. This consists of two electrodes (an anode and a cathode), which are separated by the proton exchange membrane which gives the technology its name. During operation, deionised water is fed to the anode of the electrolysis cell where it is split into oxygen, protons and electrons with the aid of a precious metal catalyst. The oxygen is vented to atmosphere from the generator. The protons travel across the membrane and simultaneously the electrons travel around the external electrical circuit. These protons and electrons then recombine at the cathode of the electrolyser, again with the aid of a precious metal catalyst to produce the hydrogen gas. The high purity of the hydrogen is assured by the membrane which completely separates the hydrogen produced at the cathode from the oxygen being produced at the anode. These processes are described by the following equations:

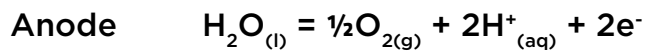
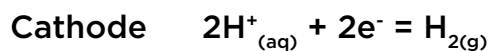

Deionised water is critical to the operation of the system and must have a purity of 1 µS/cm or better to prevent damage to the membrane. **Failure to use this grade of deionised water will invalidate the 3 year cell warranty of the generator.** The water is automatically loaded (either at power up or periodically during operation) and the rate at which the water is consumed depends on the amount of hydrogen being produced.

A small amount of the electrical energy is lost as heat and this is removed from the generator by the ventilation system.

The Peak Scientific hydrogen generator produces hydrogen on demand. By maintaining the user's pre-set pressure and using this as a reference value, the generator will produce the precise amount of hydrogen required. As soon as the demand ceases, no further hydrogen will be sent to the user's application. During this time bubbles may still be observed in the separating tank. This is due to the generator maintaining its internal pressure and ensuring that clean, dry hydrogen is available immediately on demand when the user requires it.

General Safety

The generator only produces gas when the application places a demand on the unit. The maximum quantity of hydrogen stored in the generator at any one time is 350cc at a pressure of 6.9bar (100psi). The unit also meets the European Electromagnetic Compatibility and Low Voltage Directives. The Generator is CE approved and has the CE mark attached.

All of the Precision Hydrogen generators have the necessary control circuitry, both electrical and mechanical, to ensure the shutdown of the instrument in the event of a fault or faults occurring.

Generator Safety Features

The Precision Hydrogen range have the following safety features to ensure safe and reliable operation:

1. To avoid any build up of hydrogen from leaks inside the unit; the generator features forced air ventilation. This ensures that a hydrogen / oxygen mixture cannot form inside the generator.
2. On power-up the generator self checks for internal leaks and if required it will shutdown at the end of the System Check informing the operator with a visual and audible alarm.
3. The generator will detect any hydrogen leaks that occur within the generator, the user's application and gas lines. In the event of a major leak the generator will automatically shut down within 20 minutes.
4. The hydrogen pressure inside the generator should only reach a maximum of 7.5 bar (110psi) and this is controlled in two ways:
 - a. Gas pressure is monitored and controlled electronically by a pressure sensor
 - b. A mechanical pressure switch (Fail Safe) will electrically isolate the hydrogen cell should the internal pressure reach 9 bar (130psi).
5. When the generator is in alarm status the following occurs:
 - a. The current to the cell is stopped so no hydrogen is generated therefore preventing a hazardous situation.
 - b. The over pressure relief valve opens allowing the unit to depressurise.
 - c. An audible alarm sounds and a visual alarm, relevant to the fault condition, is displayed. The generator can sense for internal and external leaks, excessive gas demand and lack of water.

Unpacking

Although Peak Scientific takes every precaution with safe transit and packaging, it is advisable to fully inspect the unit for any sign of transit damage.

Check 'SHOCKWATCH' and 'TIP-N-TELL' labels for signs of rough handling prior to unpacking.

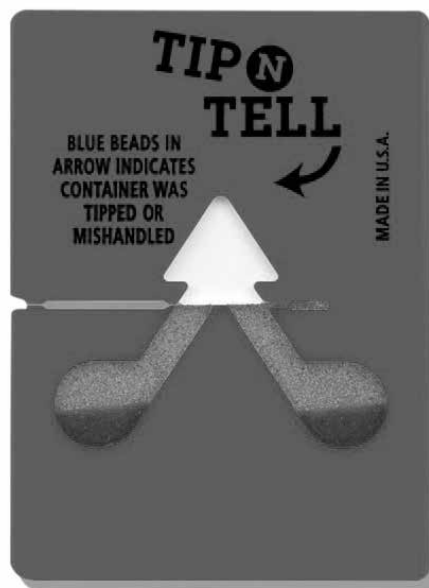

Any damage should be reported immediately to the carrier and Peak Scientific or the Peak Partner from where the unit was purchased.

Follow the unpacking instructions posted on the side of the crate. It will require two people to remove the unit from the shipping crate and to manoeuvre the generator onto the bench.

Please save the product packaging for storage or future shipment of the generator.

Note: Included with the Generator is a "Fittings Kit" containing mains power leads for UK, EU & US and also all the required fittings and warranty registration card. Be careful not to discard these with the packaging.

Fittings Kit Contents

Supplied in the Fittings Kit are all the fittings required to connect the generator to the application. The contents of the Fittings Kit are as follows:

1. Tygon Tubing	x 1m
2. Teflon Tubing	x 1m
3. Barbed Hose Fitting	x 1
4. UK Mains Power Cable	x 1
5. EU Mains Power Cable	x 1
6. US Mains Power Cable 110v	x 1
7. US Mains Power Cable 230v	x 1
8. Installation Guide- Precision Hydrogen	x 1
9. 4 or 8 Litre Water Bottle**	x 1
10. Transit Plugs	x 2

**Optional Extra, Includes additional Barbed Hose Fitting

All of the generator output ports are located on the rear of the generator.

Unpacking Instructions

The generator weight constitutes a two person lift and as such, safe lifting practices should be employed; do not attempt to lift on your own, as you will significantly increase the chance of injury & damage to yourself and others around you.

1. Remove the packing straps and lift the lid upwards.
2. Next remove the fittings kit tray and the outer cover that makes up the main box of the packaging.
3. Next, with someone on either side of the unit, position your hands underneath the unit ready to lift.
4. Ensuring your knees are bent and your back is straight, lift the unit to the desired location.

Transit Plug Removal

All hydrogen generators should be fitted with two Transit Plugs 3301437 during the packaging process. These plugs are fitted to the H₂ vent and O₂ vent of all hydrogen units and ensure no water from the internal water bottle can escape during transit.

Plugs should be removed during the installation of the generator.

These plugs require very little force to remove and will self-remove if left in the vents

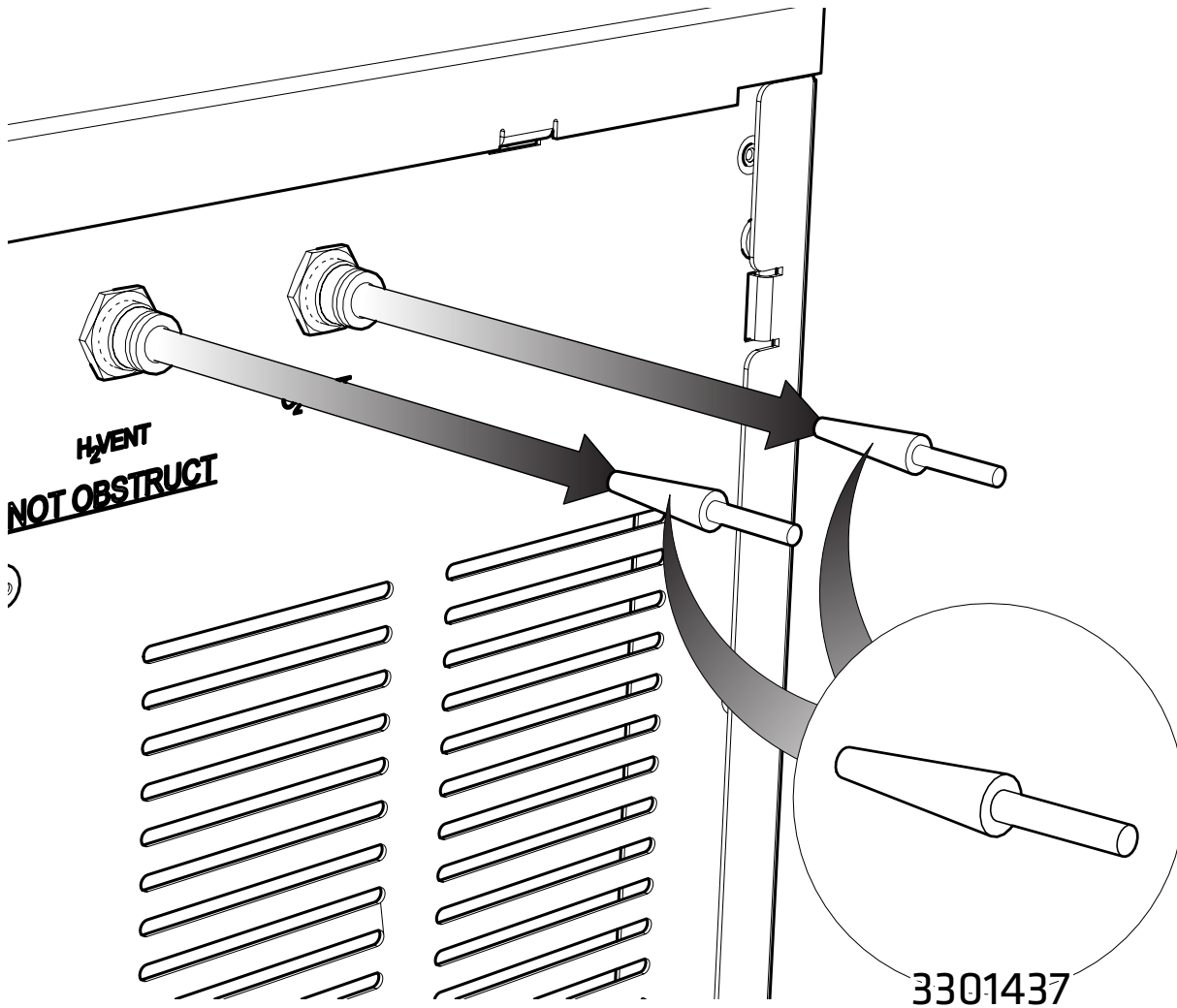

Installation

Location

The generator should be located on a flat, level surface for operation - this will ensure that the water level sensors within the unit operate correctly. Some components in the generator produce heat during operation and therefore an adequate airflow must be maintained around the generator to allow the ventilation system to perform efficiently.

If the generator is stored in an enclosed space the environment must be controlled via an air conditioner or extraction fan. The provision must be made to allow the volume of air in the room to be changed 5 times per hour. The rear of the generator will become warm to the touch during operation - a minimum clearance of 15 cm (6") from other bodies is recommended.

Do not obstruct or connect the vents to any application. Failing to observe this could lead to permanent damage of the generator.

Please ensure generator is positioned so as to permit easy disconnection if required.

Do not expose the unit to freezing conditions. Please adhere to the operating temperatures below:

Minimum Operating Ambient Temperature: 10 °C (50 °F)

Maximum Operating Ambient Temperature: 35 °C (95 °F)

Note: It is recommended that the Precision Hydrogen 1200cc unit is left to run for 3 hours, and the Precision Hydrogen Trace 1200cc unit is left to run for 24 hours before use.

Generator Overview

General Dimensions

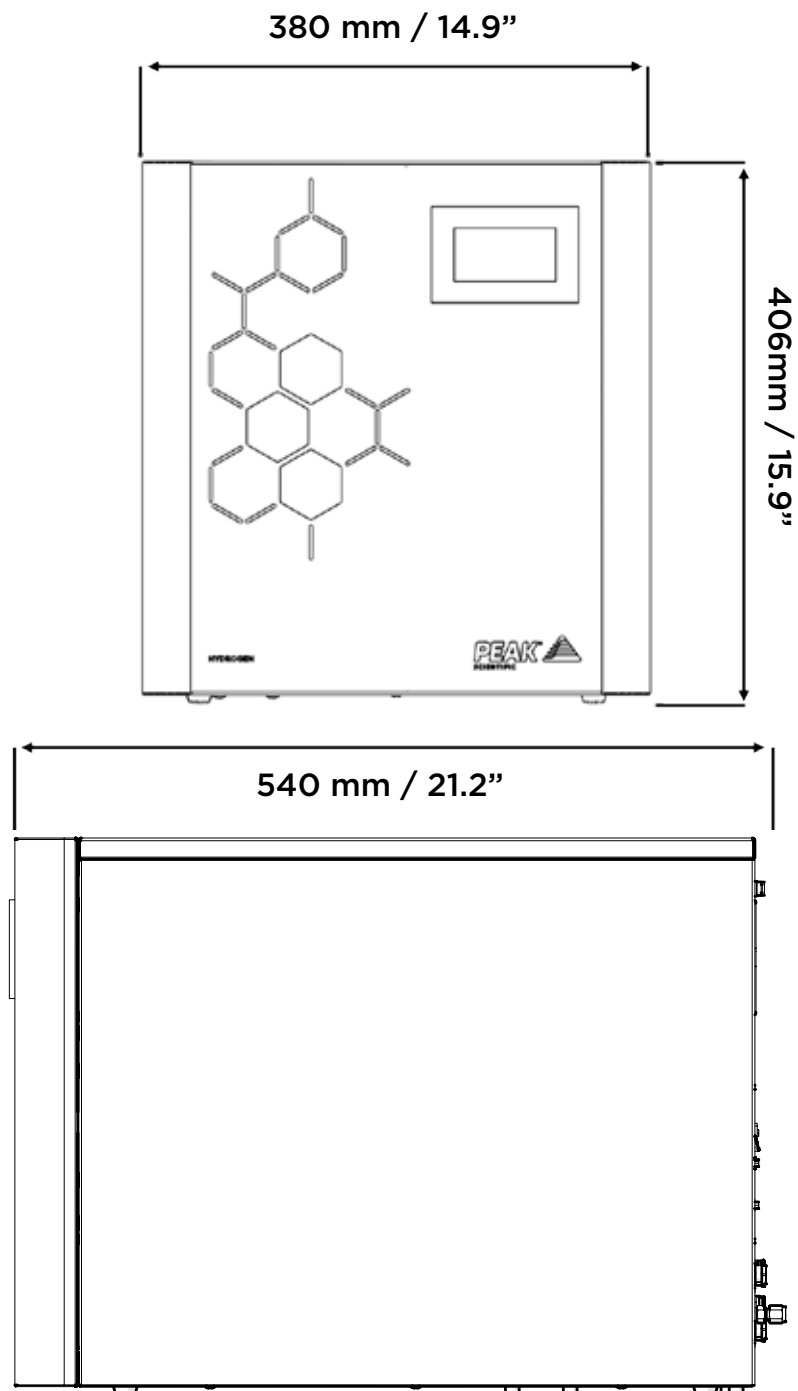

The Generator must always be placed on a flat, level surface. Failure to do so will affect the performance of the Generator.

Unit Controls

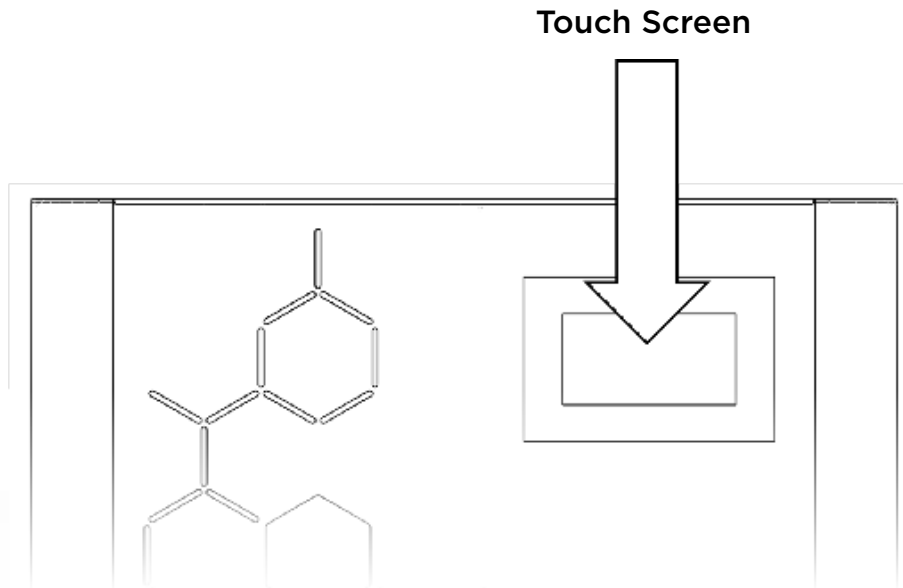

Rear Connections

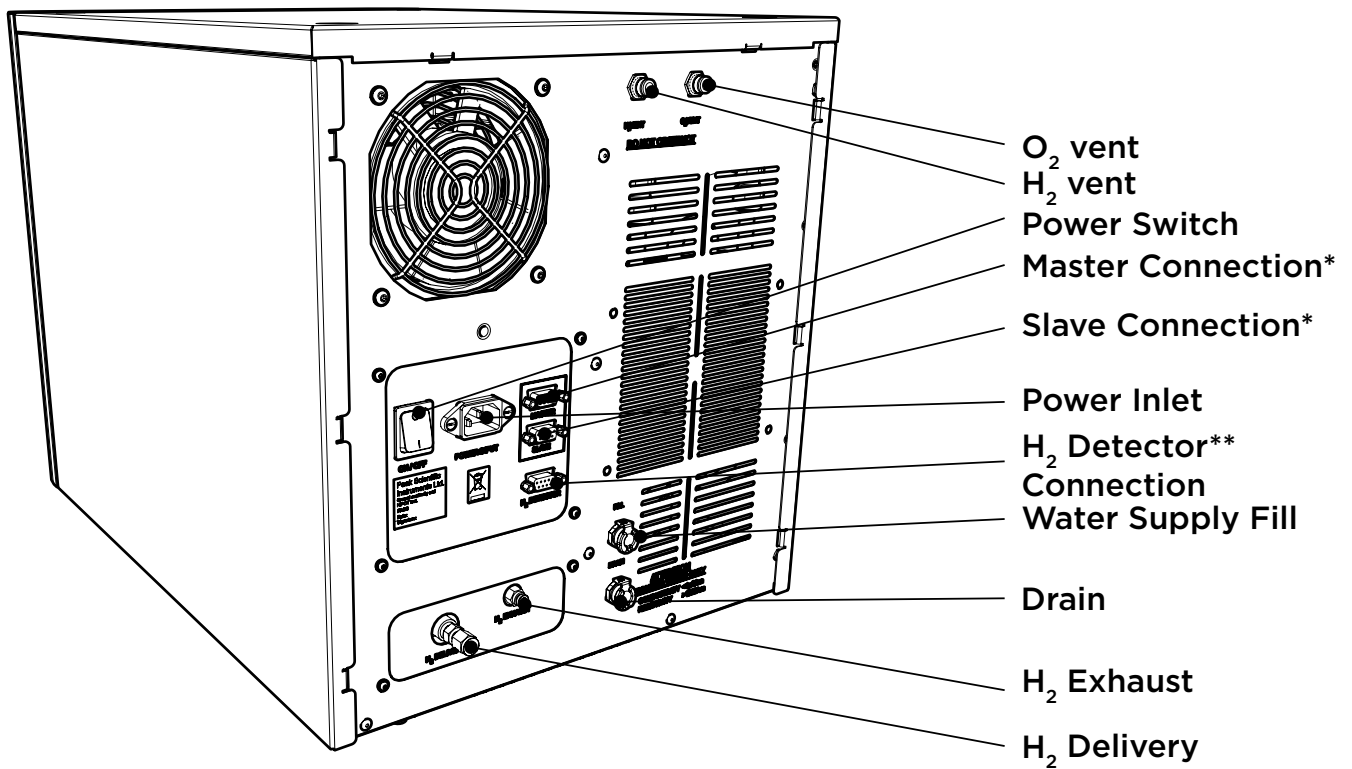

* Refer to page 29 for information on using Master and Slave connections.

** Refer to page 28 for information on using the optional H₂ Detector.

Tubing

For the hydrogen supply line, it is recommended that only clean grade copper or stainless steel tubing should be used.

Plastic tubing material such as Teflon[®], polyvinyl chloride, or Tygon[®] should not be used when plumbing GCs since these materials will allow air and water to diffuse into the gas lines. In addition, plastic tubing can give off organic impurities which can cause ghost peaks and baseline instability.

Furthermore, Peak Scientific recommend that compression fittings are used, and that the fittings are free from Teflon[®] tape.

H₂ Ventilation

Peak Scientific recommends that both the H₂ Exhaust and H₂ Vent ports at the rear of the unit should be connected to an exhaust hood, or other ventilation system, to ensure safe disposal of vented gasses. Tubing sizes for the vent ports are 4mm OD for the H₂ Exhaust and 6mm OD for the H₂ Vent.

Water Quality

Use only ASTM Type II, or better, deionised water, which must have a conductivity of less than or equal to $1\mu\text{S}/\text{cm}$ (greater than $1\text{ M}\Omega$ resistivity) @ 20°C and should be replaced as required. Water quality should be checked prior to being used to supply the Precision Hydrogen Generator.

Use of water in the Precision Hydrogen Generator with a purity not specified above will result in a reduced efficiency of hydrogen production, failure of the generator and loss of warranty.

Water should be stored in a UV protected dark container away from direct sunlight. The bottle should have a vented lid to minimise any dust or debris contaminating the water supply. A suitable external water bottle is available from Peak Scientific.

Note: Customers should check the water quality of the external water supply once a week to maintain the health of the generator.

Automatic Filling

The Precision Hydrogen generator uses an automatic water filling system, whereby sensors in the unit's internal water tanks detect when the water level reaches a minimum.

This then refills the tank using a rear connection to an external DI water supply. The unit should be connected to the water supply as shown on the next page.

Using the length of Tygon tubing and the hose barb fitting from the fittings kit, attach the barb to the tubing. Then connect one end to the water supply and the other to the Fill port at the rear of the Precision Hydrogen.

For efficient water filling the external supply should be no more than 2 metres away from the connection on the generator.



The DI Water Supply source **MUST NOT** be located higher than the height of the surface that the Precision Hydrogen generator is placed upon. A supply located higher than specified will result in the generators internal water bottle over filling.



A pressurized DI Water Supply Source will also result in the internal water bottle over filling, and therefore **MUST NOT** be used.

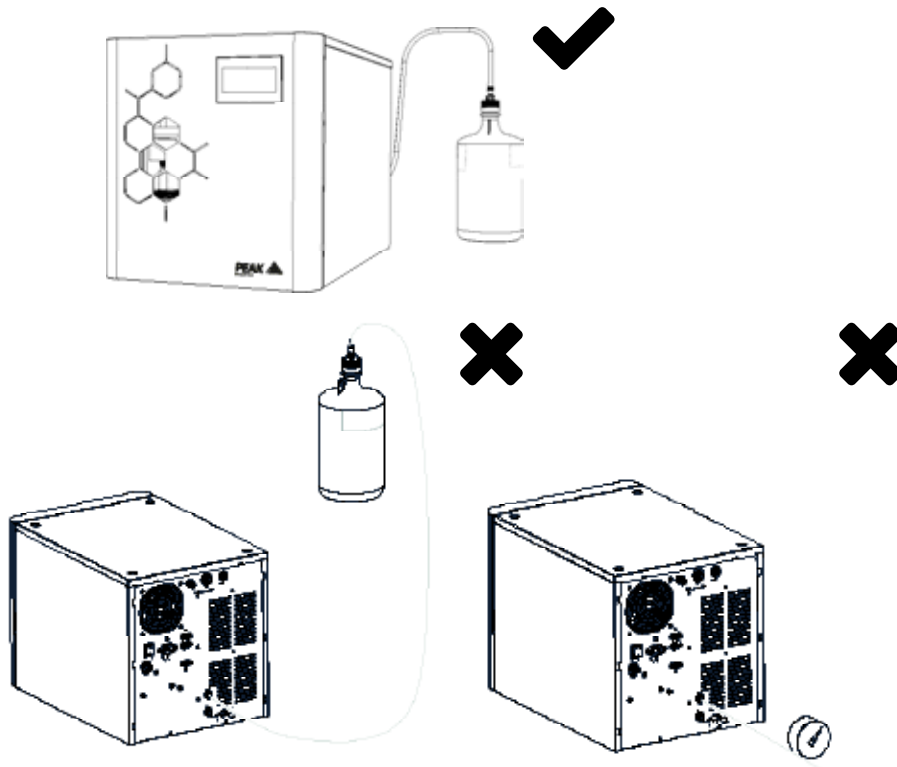

If the generator cannot load enough water to switch the sensors in the water bottle the generator will alarm providing the user with the screen below.

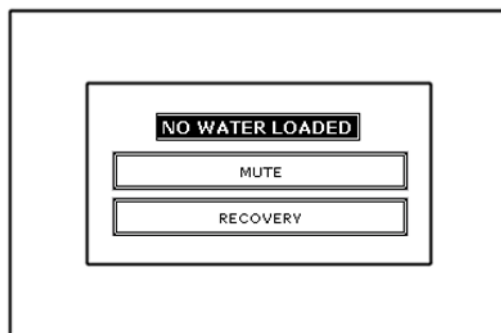

The external water supply should be checked prior to pushing the recovery button which will then re-engage the load pump and will allow the generator to continue to fill with water.

When the system detects a low water level it starts a 3 hour timer, should the system not receive enough water to switch the low level sensor it will then stop the generator from producing hydrogen. This happens to ensure that your Precision Hydrogen Generator remains in its optimum operating condition.

If the generator has reached this point the screen below will be shown on the HMI.

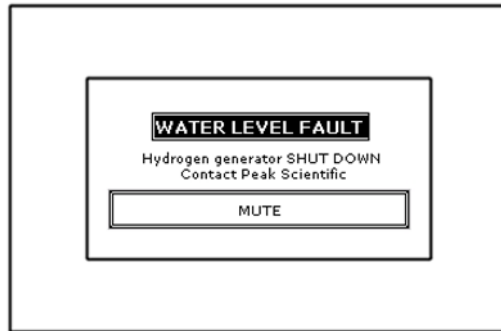

To resolve this, check your external supply before cycling the power on the generator. Once the low level water sensor disengages the generator will then begin producing hydrogen as before.

Four- and Eight-litre water storage bottles can be purchased from Peak Scientific, please contact your Sales Representative for more information.

Draining the Water Tank

1. Before draining the generator, ensure that you have tubing with a barbed connector and a vessel to collect drained water
2. Connect tubing to the 'Drain' port on the rear of the Precision Hydrogen generator using the barbed fitting with loose end in the vessel
3. Once the barbed fitting is inserted into the drain connector, water will drain from the generator's internal tank into the vessel
4. Fill the external water bottle with fresh DI water (ASTM type II)
5. Once the internal tank of the generator is emptied, connect the barbed connector to the 'Fill' port of the generator and the generator will automatically draw water from the external water bottle

Water Usage

The water consumption rate of the Precision Hydrogen 1200cc and Hydrogen Trace 1200cc Generator is shown in the below graph.

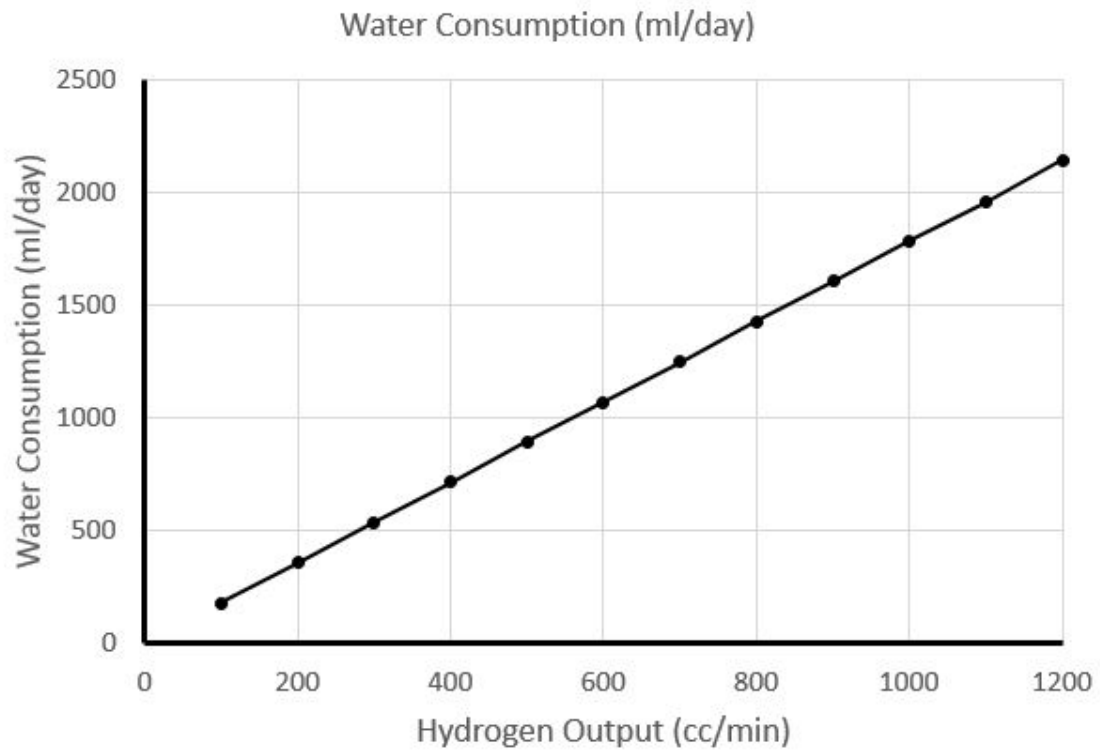

Electrical Connection

Connect the generator into an appropriate voltage supply between 100-230VAC, refer to the generator serial plate for input specification and ensure your supply matches the requirements.

If the appropriate power cord is not supplied; a new CSA, UL approved power cord, rated to at least 10 amps, can be fitted by a qualified electrician.



This unit is classified as SAFETY CLASS 1. THIS UNIT MUST BE EARTHED. Before connecting the unit to the mains supply, please check the information on the serial plate. The mains supply must be of the stated AC voltage and frequency.

EARTH/GROUND (E):- Green & Yellow or Green

LIVE (L):- Brown or Black

Neutral (N):- Blue or White

Electrical requirements are 100-230VAC nominal. However, running continuously at voltages outwith this is not recommended. Extended periods at extremes can have a detrimental effect on the operation and life of the generator.

If a substitute main supply cord is used, ensure that it has adequate rating. Failure to do so could cause damage to the generator.

Start-up Sequence

CHECK:

1. H₂ Outlet is connected to application
2. Mains power is connected

Turn the power switch ON. The digital display will light up, the cooling fans will rotate and the internal pumps may automatically run to load water if the internal tanks are not full.

On power-up the generator will check the water level, once the water level is at the minimum level required the generator will perform a diagnostic check including a leak test, this should take approximately six minutes.

Upon successful completion of the leak test, the operator is presented with the main screen and the generator is ready to deliver hydrogen.

The next screen displayed to the user will be the Home screen, where two options will be available, Start and Menu. The first time the unit is switched on the user should select the Menu option which allows the desired unit of measure and delivery pressure to be selected.

Also displayed on this screen are the Shutdown and Back options. Shutdown will depressurize the generator. This should be selected before turning the unit off using the Power switch at the rear of the unit. Finally, the Back option returns the user to the home screen where the Start option will allow the flow of hydrogen to the application.

Upon selection the unit will take a few moments to adjust to the desired delivery pressure. If the unit has been used previously the Start button will initiate the supply of hydrogen to the application at the last used pressure.

Note: If leak test is unsuccessful, an alarm will sound and a red failure screen will be displayed complete with a mute button. The user is prompted at this point to contact their Peak service provider.

Liquid Leak Detectors

Liquid leak detectors should not be used on Precision Hydrogen generators. These solutions are easily drawn into the high purity hydrogen gas system and can cause irreparable damage to a GC column. If a liquid solution has to be used, then it should be IPA based, or a portable hydrogen detector should be used.

Gas Traps

It is recommended that moisture, oxygen and hydrocarbon traps are used on the gas supply line between the Peak generator and the instrument to provide back-up contaminant protection for your instrument.

The hydrogen gas produced by the Precision Hydrogen will be sufficiently pure for these contaminant traps to last a long time, but should a leak ever occur on the gas line, the traps will ensure that any harmful contaminants are caught, therewith preventing potential damage to the instrument.

H₂ Detector Option



These are not standard serial ports, damage to serial equipment is highly likely if connected. 24Vdc signal level exists on certain pins with a maximum power rating of 5W.

The Precision Hydrogen 1200cc models can be purchased along with a H₂ detector unit. The detector is intended for use with a GC, it is recommended that the detector unit is placed above the height of the GC outlet. The detector can be wall mounted.

This unit is plugged, from the 'In' port at the rear on the detector, into the 'H₂ Detector' port at the rear of the generator, as shown below. This connection will provide the detector unit with power and allows communication between the generator and the detector unit.

The detector will take samples continuously and both the detector and the Precision Hydrogen Trace will alarm if dangerous levels of Hydrogen are detected, the Precision Hydrogen Trace will then shut down.

Multiple detectors can be connected to one generator, up to 4 in number. If this is desired, connect the first detectors 'Out' port to the second detectors 'In' port, as illustrated below.

Contact your local Peak Sales rep or distributor for ordering information on the H₂ Detector.

Precision Hydrogen (Trace)
1200cc

H₂ Detector

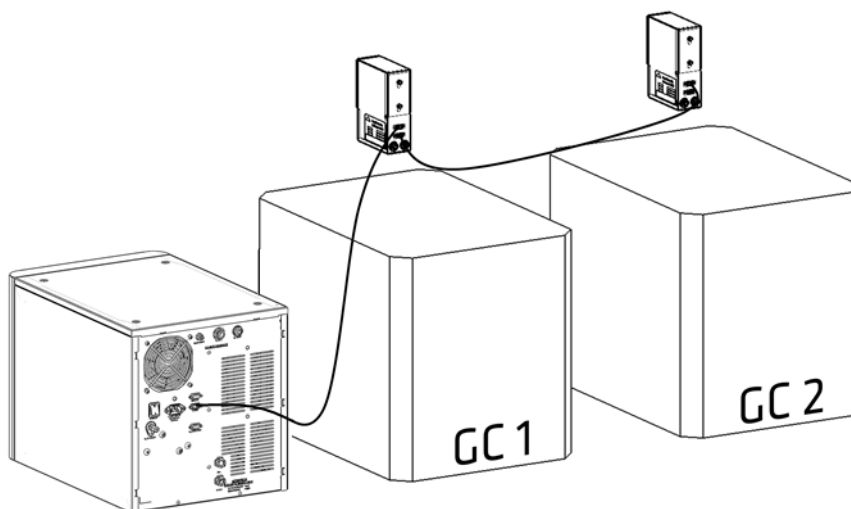
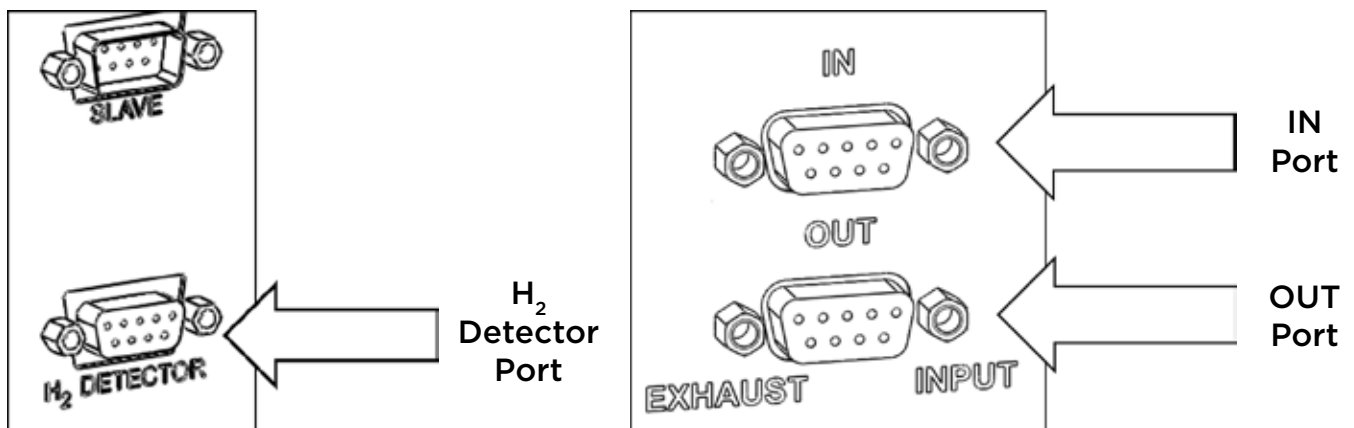

Expanding Capacity



These are not standard serial ports, damage to serial equipment is highly likely if connected. 24Vdc signal level exists on certain pins with a maximum power rating of 5W.

The Precision Hydrogen (Trace) 1200cc has an expandable feature, where the flow capacity of the unit is increased, by connecting up to 16 units in a Master-Slave format.

Rear Connections

In order to use this feature the units must be connected together via the 'Master' port on the first Precision Hydrogen (Trace) 1200cc, and the 'Slave' port at the rear of the next Precision Hydrogen (Trace) 1200cc unit.

The first Precision Hydrogen (Trace) 1200cc unit is automatically defined as the Master, and before the connections are made and H₂ is supplied, the desired pressure must be set on all units. This must be the same pressure for all.

The user can now press Start on the Master unit to begin the flow of H₂. The Master will now manage all the other units.

The Data Cables (08-8902 for B&W screen units, 08-8903 for colour screen units) used to connect units together can be purchased from Peak Scientific.

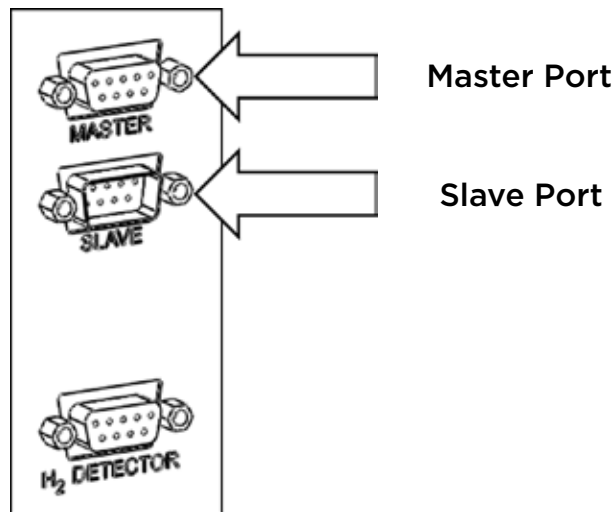

Master

Slave

EOL

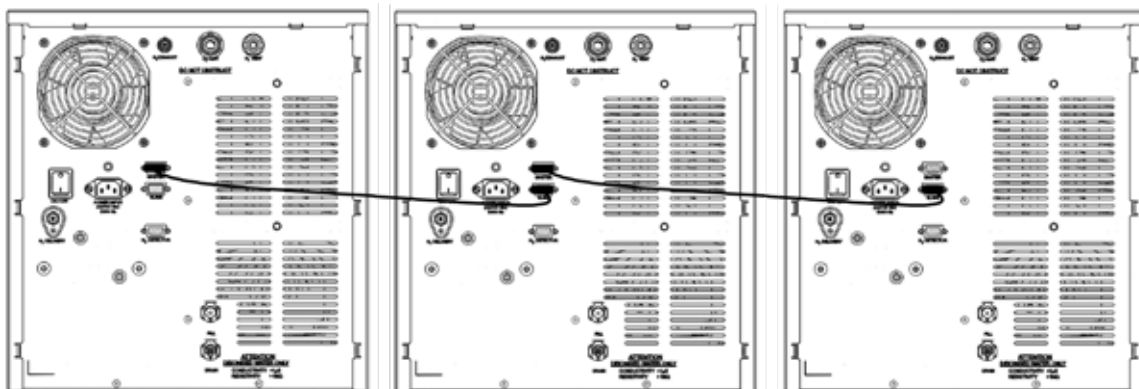

Switching the Unit Off

The unit can be switched off at any time using the following procedure.

Firstly, press the Stop button on the Touch screen, then press Menu, and finally select Shut Down.

The unit will take a few moments to depressurize after which the power switch at the rear of the generator can be switched off.

Cleaning

Clean the outside of the Generator only using warm soapy water and a clean damp cloth. Ensure the cloth is thoroughly rung out to remove excess fluid prior to use.



Cleaning should only be undertaken with the power switched off and the power cord removed from the rear of the Generator.



CAUTION

Under no circumstances should any solvents or abrasive cleaning solutions be used as these can contain fumes that could be harmful to the Generator.

Deioniser Column Replacement

Precision Hydrogen 1200cc

The deioniser column maintains the water quality of the water as it is circulated through the system and to ensure the optimum health of the generator, the resin in the deioniser column should be replaced every 12 months. Only Peak Scientific approved components should be used with the Precision Hydrogen (Trace) 1200cc, please refer to page 31 for details on ordering the required service kits.

Listed below are the instructions for replacing the deioniser column. The user will be prompted to do this by the HMI screen displaying 'Change DI Column'. However, in the event of a change being required out with the 6 month schedule, this screen can also be accessed manually.

1. From the main screen pressing MENU will bring up a menu screen with an option called COLUMN, this option should now be selected. If this is a scheduled change, the screen will already display CHANGE D.I. COLUMN. The user should select the CONTINUE option.

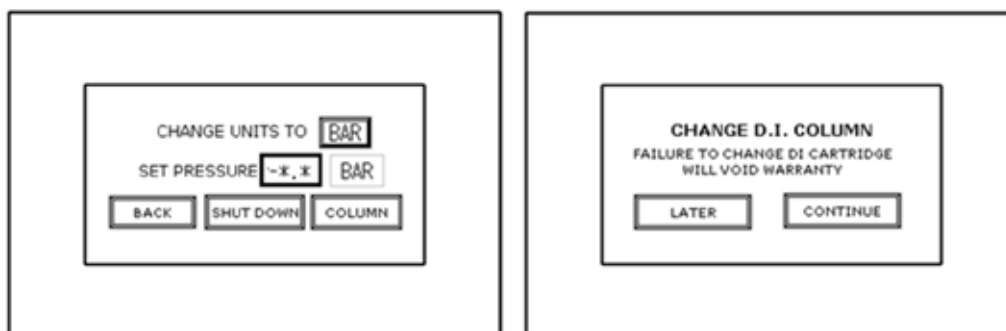

2. The two screens below will now be shown for Manual and Scheduled changes respectively. The CHANGE button on both screens should now be selected.

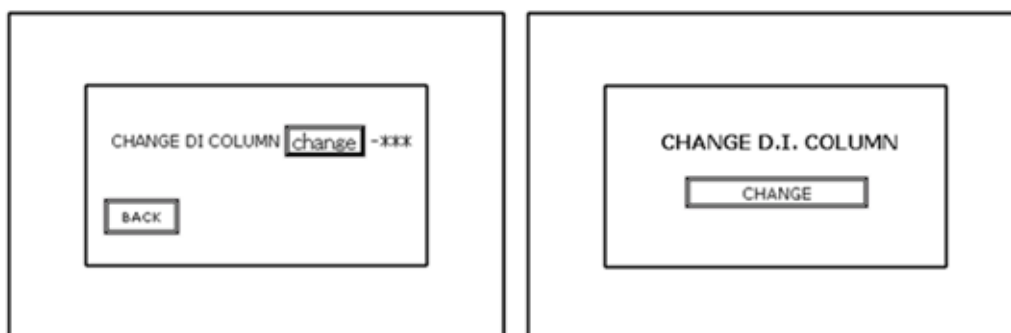

3. Remove the fascia by first pulling it forwards and then sliding it up ensuring that the HMI screen is disconnected from the unit.

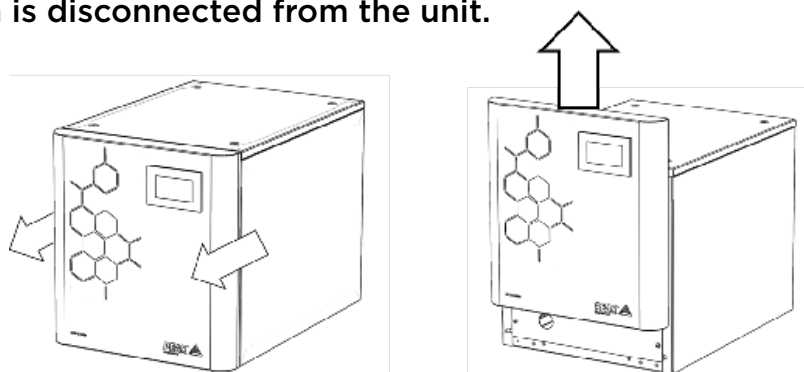

4. The deioniser column is held in place by two Velcro straps, these must be unfastened.
5. Next disconnect the deioniser column by pressing the silver tabs on the fittings at the top and bottom of the column.

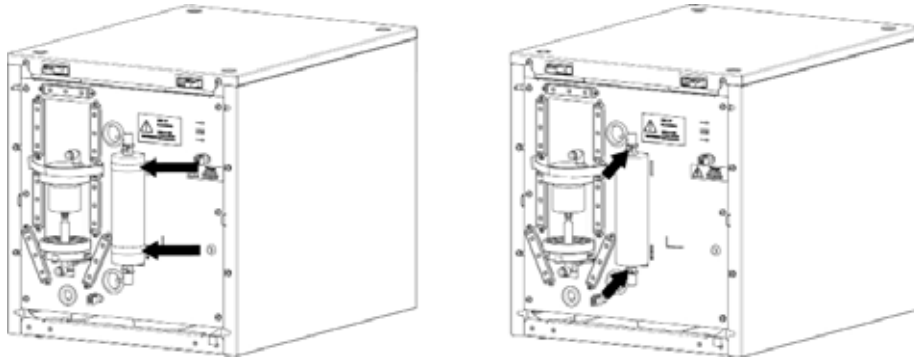

6. Remove the used column by pulling it towards you.
7. Fit a new deioniser column (05-7062) into the generator and reconnect the tubing

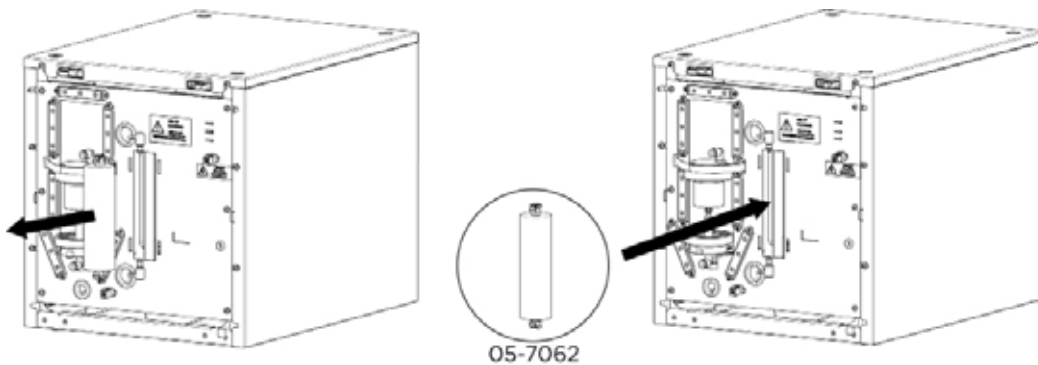

8. Refasten the Velcro straps and re-attach the front fascia, making sure to connect the HMI screen to the unit again.
9. Finally, the HMI screen will display D.I. COLUMN CHANGED? The CONFIRM button should now be selected to resume normal operation.

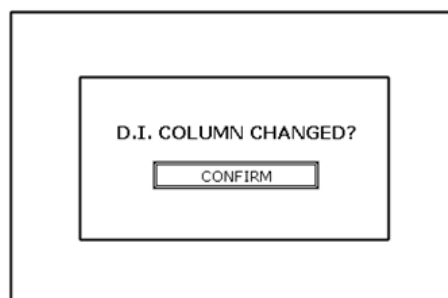

Service Requirements

Service Schedule

Purchase Interval	Component	Visit
12 Months	Precision Hydrogen 1200cc Annual Maintenance Kit	www.peakscientific.com/ordering
24 Months	Precision Hydrogen 1200cc 24 Month Interval Maintenance Kit	

Troubleshooting

Problem	Possible Solution
The Generator will not switch on and the power switch does not illuminate	<ul style="list-style-type: none"> • Ensure power cord is plugged into the Generator and that the power socket is turned on. • Check the fuse in the power cord plug. • Contact your service provider. 
Diagnostics Failed Alarm	<ul style="list-style-type: none"> • Contact your service provider.
Cell Over Voltage Alarm	<ul style="list-style-type: none"> • Contact your service provider.
Over Pressure Alarm	<ul style="list-style-type: none"> • Contact your service provider.
Capacity Excess Alarm	<ul style="list-style-type: none"> • Check external pipework for leaks. • Contact your service provider.
Water Level Fault	<ul style="list-style-type: none"> • Contact your service provider.
Low Water Supply Alarm	<ul style="list-style-type: none"> • Check water supply level and fill if necessary. • Contact your service provider.
Hydrogen detected*	<ul style="list-style-type: none"> • Check for external leaks.
The generator is not producing hydrogen	<ul style="list-style-type: none"> • Check the Customer Set Pressure is higher than 1PSI • Contact your service provider.
The generator is not producing the required amount of hydrogen at the set pressure.	<ul style="list-style-type: none"> • Check the water quality of the external supply. • Contact your service provider.

* If Hydrogen Detector is fitted.

Go Online or Complete and Return

You can register for your **FREE 3 year Warranty** with ease online at www.peakscientific.com/protected.

Alternatively, you can send the completed form to Peak Scientific by post or email at warranty@peakscientific.com.

Go Online or Complete and Return

You can register for your **FREE 12 month Warranty** with ease online at www.peakscientific.com/protected.

Alternatively, you can send the completed form to Peak Scientific by post or email at warranty@peakscientific.com.

Product Warranty Registration			
Contact name			
Email address			
Company			
Address			
City/town			
Postcode			
Country			
Telephone			
Generator serial #			
Model type			
Installation date			
Do you still use an alternative gas solution i.e. cylinders or bulk liquid?	Yes	No	
What gas requirements do you have in your lab?	Hydrogen	Nitrogen	Zero Air

Extend your cover with

Peak Scientific offer comprehensive gas generator after sales support packages. Peak [Protected] aftercare support can guarantee an on-site response within 72 hours*, genuine parts from our ISO9001 approved factory and a 95% first-time fix rate. See our enclosed Peak [Protected] leaflet for further information.

Important!

You have 1 month to register your Peak Scientific product from the date of installation. Once registered the warranty will be honoured for a period of 12 months. If you wish to defer the installation of your generator, you must notify Peak Scientific immediately by emailing warranty@peakscientific.com. For generators that remain unregistered after 1 month from the shipment date, the warranty will be considered active from the date of factory dispatch.

* Complete Plan only

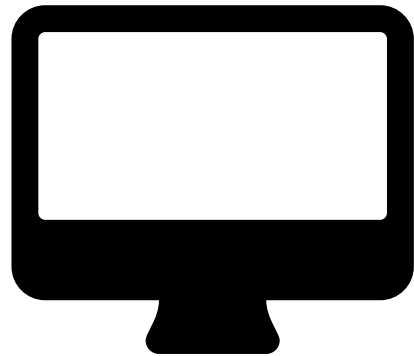

Important!

You have **1 month to register** your Peak Scientific product from the date of installation. Once registered the warranty will be honoured for a period of **3 years**. If you wish to defer the installation of your generator, you must notify Peak Scientific immediately by emailing warranty@peakscientific.com. For generators that remain unregistered after 1 month from the shipment date, the warranty will be considered active from the date of factory dispatch.

[PEAK Protected]TM

Peak Scientific has highly trained, fully certified Field Service Engineers located in over 20 countries across every continent around the world. This allows us to provide an industry-leading rapid response service to our customers. With **[Peak Protected]**, your laboratory's productivity becomes our top priority.

To discuss Peak Protected generator cover and payment options speak to your local Peak Representative or for further information contact: protected@peakscientific.com

Peak Scientific
Fountain Crescent
Inchinnan Business Park
Inchinnan
PA4 9RE
Scotland, UK
Tel: +44 141 812 8100
Fax: +44 141 812 8200

For further information on any of our generator products please contact marketing@peakscientific.com

