

Genius XE (All Models)

User Manual

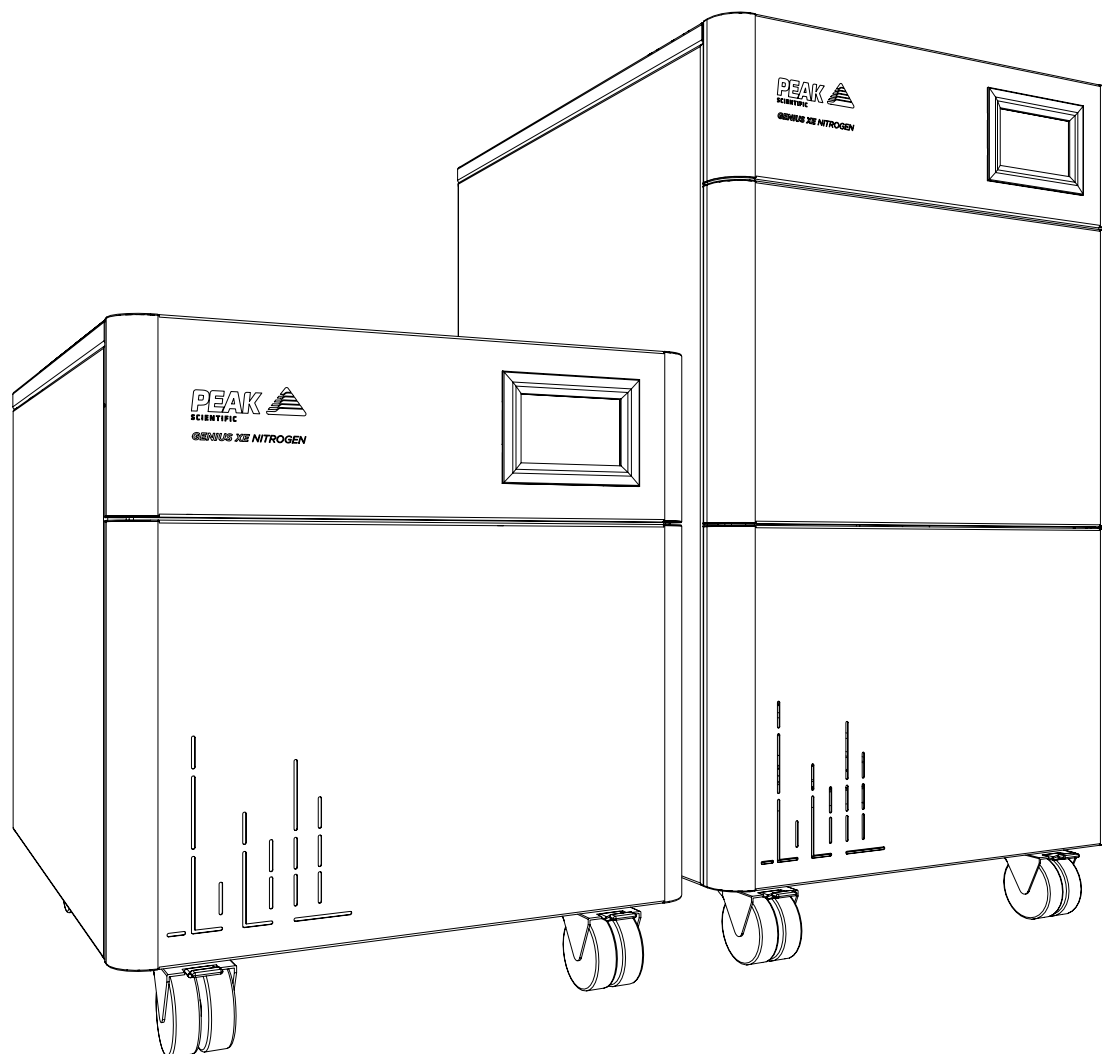

PEAK 
SCIENTIFIC

Register Product to Operate

To begin operation you will need to register your generator. You can do so by **visiting www.peakscientific.com/activate** or by **downloading the Peak Genius App**.

Registering will activate your **2 year warranty*** - covering every single component in your generator.





Important!

You must register your generator before nitrogen generation can commence. In order to be eligible for warranty your generator must be registered to the end user (not a reseller or distributor) and must have a paid annual preventative maintenance arranged within 13 months of the installation date & carried out by a Peak approved Field Service Engineer. Once registered the warranty will be honoured for a period of 24 months.**

* 2nd year warranty subject to completion of preventative maintenance visit arranged within 13 months of installation. For terms and conditions please visit www.peakscientific.com/warranty-statement/

** Call out and labour charges may apply where generator was not purchased directly from Peak

Contents

Change History	4
How to use this Manual	4
Warranties and Liabilities	5
Safety Notices	7
EU Declaration of Conformity	8
UK Declaration of Conformity	10
WEEE Compliance Statement	12
EMC Class A Compliance Statements	14
Technical Specification	15
Environment	15
Unpacking	16
Fittings Kit Contents	17
Installation	18
Generator Environment	18
Operation in High Ambient Temperatures	18
Generator Overview	19
General Dimensions	19
Genius XE 35	19
Genius XE 70	19
Rear Connections	20
Genius XE 35 & 70	20
Genius XE 35 (771055721 Serial Numbers onwards)	20
Unit Controls	21
Drain Connection	22
Electrical Connection	23
Start-Up Sequence	24
Product Registration	25
Connecting to the application	28
Tubing Lengths	28
Setting the Output Pressure	29
Normal Operation XE 35	30
Eco Mode	30
Service Screens	31
Error Screens	32
Information Screens	33
Settings Screens	33
Service Log-in Screen	33
Service Log-in Screen	33
Unusual Operation	33
Normal Operation XE70	34
Eco Mode	34
Service Screens	35
Error Screens	36
Information Screens	37
Settings Screens	38
Service Log-in Screen	38
Unusual Operation	38
Service Requirements	39
Service Schedule	39
Service Indication	40
Stage 1 	40
Stage 2 	40
Service Indication Reset	40
Peak Protected	41
Cleaning	42
Alarm Messages	43
Troubleshooting	44

Change History

Rev	Comment	Name	Date
1	Initial Release	Liam Couttie	25/04/2018
2	Fittings Kit Update	Liam Couttie	18/07/2018
3	Technical Specification Update	Liam Couttie	07/01/2019
4	Env. Declarations Update	Liam Couttie	24/06/2019
5	Power Cord Update	Liam Couttie	15/10/2019
6	Accreditations Update	Liam Couttie	18/10/2019
7	Warranty Info Update	Liam Couttie	20/11/2019
8	Technical Specification Update	Liam Couttie	16/12/2019
9	Technical Specification Update	Liam Couttie	18/02/2020
10	Genius XE 35 Build Update	Liam Couttie	23/06/2020
11	Transformer Voltage Update	Liam Couttie	22/06/2021
12	Declarations Update	Liam Couttie	16/08/2021
13	Generator Updates	Liam Couttie	13/01/2022
14	Declarations Update	Liam Couttie	09/01/2023
15	Declarations Update	Liam Couttie	02/10/2023
16	Declarations Update	Liam Couttie	30/01/2024

How to use this Manual

This manual is intended for end users and has been written as a reference document where you can skip to the relevant information.

Users can refer to the contents page to find the relevant information.

Please review each of the following sections carefully.

Thank you for selecting Peak Scientific to meet your gas generation needs, should you require any further assistance or support please do not hesitate to contact Peak Scientific or the Peak Partner from which you purchased your generator.

Warranties and Liabilities

Warranty & Liability Coverage

1. Peak warrants that, subject to the provisions in this statement, purchased Peak generators, whether purchased directly from Peak or indirectly via an approved, certified and trained distributor or partner (referred to hereafter as a “Peak Partner”) will comply in all material respects with any specifications referred to in your customer order confirmation and, subject to installation and operational guidelines being followed as described in applicable product manuals, shall be free from any defects in quality of materials or workmanship for a period of one year from the date of installation, provided this takes place within 3 months of factory dispatch.
2. Where the purchased generator is from the Precision Hydrogen series, Peak further warrants that, subject to installation and operational guidelines being followed as described in applicable product manuals, the hydrogen cell shall be free from any defects in quality of materials or workmanship for a total period of three years (inclusive of warranty period specified in clause 1) from date of installation, provided this takes place within 3 months of factory dispatch.
3. Where the purchased generator is from the i-Flow 6000 series, Peak further warrants that, subject to installation and operational guidelines being followed as described in applicable product manuals, the generator shall be free from any defects in quality of materials or workmanship for a total period of two years (inclusive of warranty period specified in clause 1) from the date of installation, provided this takes place within 3 months of factory dispatch and the following provisions have also been met:
 - a. you must purchase a service plan, ensuring the generator is serviced by Peak or a Peak Partner on or before the end of the first 12 months of your ownership, and serviced at least once during each subsequent 12 month period thereafter;
 - b. the generator (and any associated equipment) must have been commissioned by Peak or a Peak Partner;
 - c. the feed air or inlet air supply to the generator must comply with ISO 8573-1:2010 Class 1.2.1 at all times;
 - d. your air compressor, dryer, filtration and oil removal systems must be deemed suitable for use by Peak or a Peak Partner, and must be changed and serviced regularly, in line with the equipment manufacturer’s recommended guidelines; and
 - e. any generator failure or fault that is deemed to have been caused by the failure of any upstream equipment, component, part or system (such as air compressor, air treatment or filtration) will be excluded from the warranty described herein.
4. Where the purchased generator is from the Genius XE range, Peak further warrants that, subject to installation and operational guidelines being followed as described in applicable product manuals, the generator shall be free from any defects in quality of materials or workmanship for a total period of two years (inclusive of warranty period specified in clause 1) from the date of registration, provided the following provisions have also been met:
 - a. The product must be registered within 12 months of the build date, to the end user (registrations to 3rd party resellers or other channel partners will not qualify for the warranty extension).
 - b. You must purchase a service plan, ensuring the generator is serviced by Peak or a Peak Partner on or before the end of the first 13 months of your ownership
 - c. The product is required to be serviced in accordance with manufacturer requirements, preventative maintenance visit must be arranged within 13 months of installation, and the generator must be serviced by Peak, or a Peak Partner within 13 months of installation.
 - d. Products purchased via Peak Partners may be subject to call-out and labor charges, which is at the discretion of the Peak Partner.
5. Peak also warrants that any replacement parts whether purchased (directly from Peak, or via a Peak Partner) or supplied as part of any remedial action undertaken in line with the provisions of clauses 13 and 14, shall be free from any defects in quality of materials or workmanship for a period of 180 days from the date of factory dispatch, provided its installation is performed by Peak or a Peak Partner.
6. This warranty does not exclude Peak’s liability in respect of any claim for death or personal injury to

any person, in so far as such can be attributed to negligence or breach of duty of care directly resulting from failure of Peak to comply with the provisions in clauses 1, 2, 3, 4 & 5.

Exclusions & Limitations

7. This warranty does not cover:
 - a. damage, deterioration or malfunction resulting from an alteration or modification to a generator which has not been carried out by Peak or a Peak Partner;
 - b. damage, deterioration or malfunction resulting from what Peak reasonably believes to be abuse, or misuse of a generator by you or any third party;
 - c. liability for accident or neglect (other than pursuant to clause 6);
 - d. maintenance or repairs which have not been carried out by Peak or a Peak Partner;
 - e. operation of a generator or exposure of a generator to environmental conditions that fall out-with operational guidelines as specified in the applicable product user manual; and
 - f. lightning, power surges or any other acts of God or nature.
8. This warranty is non-transferrable. Only the original owner of the generator may benefit from the terms within this statement.
9. Peak shall not be liable in respect of any claim made for costs, damages, losses or expenses (whether consequential, direct, indirect or otherwise) or in any respect howsoever arising including, but not limited to, liability from accident or negligence (other than pursuant to clause 6) that may be suffered by you or any third party.
10. No person or entity is authorised to change the terms and conditions outlined in this warranty statement in any respect, or to create any additional obligations or liabilities for any party involved.
11. This warranty statement supersedes any and all prior warranty agreements between the parties and constitutes the complete, final and exclusive understanding of the parties with respect to the subject matter. All prior negotiations, representations, or promises, whether oral or written, of either party shall be deemed to have been merged herein.
12. If any part of this warranty statement is invalidated, for whatever reason, such part will be deleted and the rest shall remain unaffected, continuing to be in full force and effect.

Delivery of Warranty Service



13. Subject to clause 14, and:
 - a. Peak being notified by you, within the duration of the applicable warranty period, of any defect that you think is subject to any warranty valid under clauses 1, 2, 3, 4 or 5; and
 - b. Peak being permitted to inspect the generators, parts and their installation (along with any relevant packaging)
Peak shall at its option repair or replace defective generators or parts (including, if necessary, any moving parts and irrespective of runtime). No additional charges will apply, for parts or delivery and, where applicable, labour or travel. Peak will endeavour to deliver this service within 3 working days of your notification.
14. Where, in Peak's reasonable opinion, a defect is subject to an exclusion described in clause 7, Peak reserves the right to charge for parts or delivery and, where applicable, you may also be charged by Peak for call out, labour or travel in respect of any repair or replacement which you authorize Peak to carry out.

Safety Notices

Peak Scientific Instruments cannot anticipate every possible circumstance which may represent a potential hazard. The warnings detailed within this manual refer to the most likely potential hazards, but by definition cannot be all inclusive. If the user employs an operating procedure, item of equipment or a method of working which is not specifically recommended by Peak Scientific, the user must ensure that the equipment will not be damaged or become hazardous to persons or property.

Symbols

This manual uses the following symbols to highlight specific areas important to the safe and proper use of the generator.

 WARNING	A WARNING notice denotes a hazard. It calls attention to an operating procedure, process or similar, which if not correctly performed or adhered to, could cause personal injury or in the worst case death. Do not proceed beyond a WARNING notice until the indicated conditions are fully understood or met.
 CAUTION	A CAUTION notice denotes a hazard. It calls attention to an operating procedure, process or similar, which if not correctly performed or adhered to, could cause damage to the generator or the application. Do not proceed beyond a CAUTION notice until the indicated conditions are fully understood or met.
	Caution, risk of electric shock. Ensure power to the generator has been removed before proceeding.

Safety Notice to Users



These instructions must be read thoroughly and understood before installation and operation of your Peak Generator. Use of the generator in a manner not specified by Peak Scientific MAY impair the SAFETY provided by the equipment.



When handling, operating or carrying out any maintenance, personnel must employ safe engineering practices and observe all relevant local health and safety requirements and regulations. The attention of UK users is drawn to the Health and Safety at Work Act 1974, and the Institute of Electrical Engineers regulations.



If the equipment is used in a manner not specified by the manufacturer, the protection provided by the equipment maybe impaired.

EU Declaration of Conformity

We Peak Scientific Instruments Ltd.
Of Fountain Crescent, Inchinnan, Renfrewshire, PA4 9RE

Hereby declare that, this declaration of conformity is issued under the sole responsibility of the manufacturer.

Equipment Type: Nitrogen Gas Generator
Model Designator: Genius XE 35

To which this declaration relates, is in conformity with the following applicable EU Directives, harmonized standards, and other normative requirements.

- **Low Voltage Directive 2014/35/EU**
EN 61010-1: 2010/ A1:2019 Safety Requirements for Electrical Equipment for Measurement, Control and Laboratory Use.
- **Electromagnetic Compatibility Directive 2014/30/EU**
EN 61326-1: 2013 Electrical Equipment for Measurement, Control and Laboratory Use - EMC Requirements. (Class A)
- **Restriction on the use of certain hazardous substances in electronic equipment (RoHS) Directive 2011/65/EU as amended by EU 2015/863.**

Signed for and on behalf of Peak Scientific by

Signed:



Name: Fraser Dunn

Position: Design Engineering Manager
Peak Scientific Instruments Ltd,
Inchinnan, Renfrew, Scotland, PA4 9RE, UK.

Date: 5th January 2024



EU Declaration of Conformity

We Peak Scientific Instruments Ltd.
Of Fountain Crescent, Inchinnan, Renfrewshire, PA4 9RE

Hereby declare that, this declaration of conformity is issued under the sole responsibility of the manufacturer.

Equipment Type: Nitrogen Gas Generator
Model Designator: Genius XE 70

To which this declaration relates, is in conformity with the following applicable EU Directives, harmonized standards, and other normative requirements.

- **Low Voltage Directive 2014/35/EU**
EN 61010-1: 2010 + A1:2019 Safety Requirements for Electrical Equipment for Measurement, Control and Laboratory Use.
- **Electromagnetic Compatibility Directive 2014/30/EU**
EN 61326-1: 2013 Electrical Equipment for Measurement, Control and Laboratory Use - EMC Requirements. (Class A)
- **Restriction on the use of certain hazardous substances in electronic equipment (RoHS) Directive 2011/65/EU as amended by EU 2015/863.**

Signed for and on behalf of Peak Scientific by

Signed:



Name: Fraser Dunn

Position: Design Engineering Manager
Peak Scientific Instruments Ltd,
Inchinnan, Renfrew, Scotland, PA4 9RE, UK.

Date: 15th July 2023



UK Declaration of Conformity

We Peak Scientific Instruments Ltd.
Of Fountain Crescent, Inchinnan, Renfrewshire, PA4 9RE

Hereby declare that, this declaration of conformity is issued under the sole responsibility of the manufacturer.

Equipment Type: Nitrogen Gas Generator
Model Designator: Genius XE 35

To which this declaration relates, is in conformity with the following applicable UK Statutory Instruments, Standards and other normative requirements.

- **The Electrical Equipment (Safety) Regulations 2016 (SI 2016 / 1101) as amended.**
BS61010-1:2010 / A1:2019 Safety Requirements for Electrical Equipment for Measurement Control and Laboratory Use.
- **The Electromagnetic Compatibility Regulations 2016 (SI 2016 / 1091) as amended.**
BS61326-1:2013 Electrical Equipment for Measurement , Control and Laboratory Use - EMC Requirements. (Class A)
- **The Restriction of the Use of Certain Hazardous Substances in Electrical and Electronic Equipment Regulations 2012 (SI 2012 / 3032) as amended.**

Signed for and on behalf of Peak Scientific by

Signed: 
Name: Fraser Dunn

Position: Design Engineering Manager
Peak Scientific Instruments Ltd,
Inchinnan, Renfrew, Scotland, PA4 9RE, UK.

Date: 5th January 2024



UK Declaration of Conformity

We Peak Scientific Instruments Ltd.
Of Fountain Crescent, Inchinnan, Renfrewshire, PA4 9RE

Hereby declare that, this declaration of conformity is issued under the sole responsibility of the manufacturer.

Equipment Type: Nitrogen Gas Generator
Model Designator: Genius XE 70

To which this declaration relates, is in conformity with the following applicable UK Statutory Instruments, Standards and other normative requirements.

- **The Electrical Equipment (Safety) Regulations 2016 (SI 2016 / 1101) as amended.**
BS61010-1:2010 + A1:2019 Safety Requirements for Electrical Equipment for Measurement Control and Laboratory Use.
- **The Electromagnetic Compatibility Regulations 2016 (SI 2016 / 1091) as amended.**
BS61326-1:2013 Electrical Equipment for Measurement , Control and Laboratory Use - EMC Requirements. (Class A)
- **The Restriction of the Use of Certain Hazardous Substances in Electrical and Electronic Equipment Regulations 2012 (SI 2012 / 3032) as amended.**

Signed for and on behalf of Peak Scientific by

Signed: 
Name: Fraser Dunn

Position: Design Engineering Manager
Peak Scientific Instruments Ltd,
Inchinnan, Renfrew, Scotland, PA4 9RE, UK.

Date: 15th July 2023



WEEE Compliance Statement

The Waste Electrical and Electronic Equipment (WEEE) Regulations SI 2013 No 3113 and or the Waste Electrical and Electronic Equipment (WEEE) Directive 2012/19/EU apply to all electrical and electronic equipment placed on the market in the UK and EU covered by the scope of regulations which can be found in the Government Guidance Notes (PDF) produced by the Department for Business Innovation and skills for the UK and here for Europe.

All PEAK products that are subject to the WEEE directive are compliant with the WEEE marking requirement. Such products are marked with the “crossed-out wheellie bin” symbol (shown below) in accordance with European standard EN50419. All old electrical equipment can be recycled. Please do not dispose of any electrical equipment (including those marked with this symbol) in general rubbish bins. Please contact your dealer or distributor for clarity.

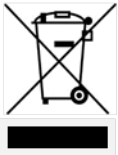

CSA Compliance Statement

CSA Group (Canadian Standards Authority) is a Nationally Recognised Testing Laboratory (NRTL), headquartered in Toronto Canada.

They are authorised to evaluate product to both their own and Underwriters Laboratory (UL) standards and certify the product to be in compliance to the relevant standards.

Peak products are certified to the current in force revision of the following standards in order to cover both Canadian and United States requirements for “Safety Requirements for Electrical Equipment for Measurement, Control and Laboratory use, Part 1: general Requirements”.

Canada: CAN/CSA C22.2 No 61010-1-12

United States: UL 61010-1

As a result the products covered by this statement are certified and listed by CSA accordingly and are entitled to carry the CSA mark with both Canadian and United States subscripts , as shown below on the product rating label.



EMC Class A Compliance Statements

European Union (EU) and United Kingdom (UK) Class A Compliance statement

This is a Class A product. In a domestic environment this product may cause radio interference in which case the user may be required to take adequate measures.

FCC Class A Compliance Statement

This equipment has been tested and found to comply with the limits for a Class A digital device, pursuant to part 15 of the FCC Rules. These limits are designed to provide reasonable protection against harmful interference when the equipment is operated in a commercial environment. This equipment generates, uses, and can radiate radio frequency energy and, if not installed and used in accordance with the instruction manual, may cause harmful interference to radio communications. Operation of this equipment in a residential area is likely to cause harmful interference in which case the user will be required to correct the interference at his own expense.



Industry Canada Class A emission compliance statement

This ISM device complies with Canadian ICES-001 (A).

Cet appareil ISM est conforme à la norme NMB-001 (A) du Canada.

Korea Communications Commission (KCC) statement

이 기기는 업무용(A급)으로 전자파적합기기로서 판매자 또는 사용자는 이 점을 주의하시기 바라며, 가정외의 지역에서 사용하는 것을 목적으로 합니다.

(This is electromagnetic wave compatibility equipment for business (Type A). Sellers and users need to pay attention to it. This is for any areas other than home.)

Technical Specification

Environment

	XE 35	XE 70
Minimum Operating Ambient Temperature	5°C / 41°F	
Maximum Operating Ambient Temperature	35°C / 95°F	
Maximum Altitude	3000m	
Maximum Relative Humidity	80% @ 35°C	
Minimum Storage Temperature*	-20°C / -4°F	
Maximum Storage Temperature*	60°C / 140°F	

Generator Outlets

Max Gas Outlet Pressure	116 psi / 8 bar	
Max Gas Outlet Flow Rate [†]	35 L/min	70 L/min
Purity	Up to 99.5%	
Particles	<0.01µm	
Phthalates	Phthalate & BHT Free	
Suspended Liquids	None	
Hydrocarbon Removal	<1ppm NMHC	
Gas Outlets	1 x 1/4" BSPP	
Drain Outlet	1 x 1/4" BSPP	
Pressure Gauges/Displays	2	
Start-Up Time	30 mins	

Electrical Requirements

Voltage	120V±5% / 230V±10%	230V±10%
Frequency	120V 60Hz / 230V 50/60Hz	230V 50/60Hz
Current	12A @ 120V / 8A @ 230V	12A @ 230V
Input Connection	C20 Plug	
Power Cord	C19 Socket	
Circuit Breakers	230V 6A MCB, 2A MCB 120V 10A MCB, 2A MCB	
Pollution Degree	2	
Insulation Category	Class 1	
Transient Over Voltages	Over Voltage Category II	

General

Dimensions cm (inches) H x W x D	650 x 570 x 710 mm (25.6 x 22.5 x 28")	1000 x 570 x 710 mm (39.4 x 22.4 x 28.0")
Generator Weight Kg (lbs)	92 Kg (202.9 lbs)	147 Kg (324.1 lbs)
Shipping Weight Kg (lbs)	129 Kg (284.4 lbs)	182.5 Kg (402.4 lbs)
Noise Level [‡]	55.5 dBA	59.3 dBA

* Note: Please ensure Generator is situated in a well ventilated environment.

[†] Note: Flows in LPM are expressed as normalised volumes at 101.3 kPa, 20°C

[‡] Note: Noise level expressed as SPL (Sound Pressure Level) measured at 1m from source in a reverberant chamber in accordance with ISO 3741:2010.

Unpacking

Although Peak Scientific takes every precaution with safe transit and packaging, it is advisable to fully inspect the unit for any sign of transit damage.

Check 'SHOCKWATCH' and 'TIP-N-TELL' labels for signs of rough handling prior to unpacking.

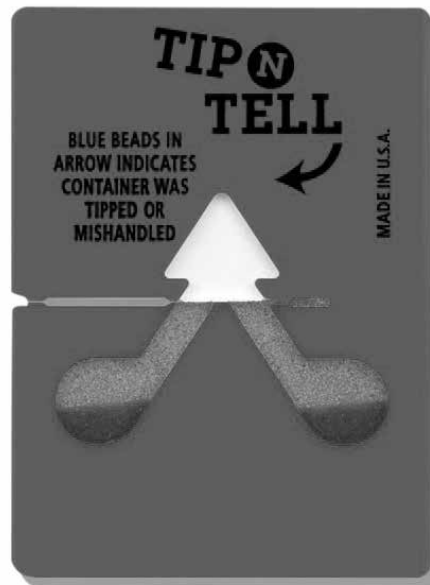

Any damage should be reported immediately to the carrier and Peak Scientific or the Peak Partner from where the unit was purchased.

Follow the unpacking instruction supplied with the generator. It will require two people to remove the unit from the shipping crate and to manoeuvre the generator to the desired location.

Please save the product packaging for storage or future shipment of the generator.

Note: Included with the generator is a "Fittings Kit" containing mains power leads for UK, EU & US and also all the required fittings and warranty registration card. Be careful not to discard these with the packaging.

Fittings Kit Contents

Supplied in the Fittings Kit are all the fittings required to connect the generator to the application. The contents of the Fittings Kit are as follows:

Genius XE 35 (120V)

1. 1/4" x 1/4" Compression Fitting	x 1
2. 1/4" x 6mm Push-Fit Fitting	x 2
3. Flow Control Silencer	x 1
4. 1/4" PTFE Tubing	x 3m
5. 6mm PTFE Tubing	x 3m
6. 6mm Polyethylene Tubing	x 3m
7. 4mm Hex Key	x 1
8. US 120V Mains Power Cable	x 1
9. Genius XE Installation Guide	x 1

Genius XE 35 & XE 70 (230V)

1. 1/4" x 1/4" Compression Fitting*	x 1
2. 1/4" x 6mm Push-Fit Fitting**	x 2
3. Flow Control Silencer	x 1
4. 1/4" PTFE Tubing*	x 3m
5. 6mm PTFE Tubing*	x 3m
6. 6mm Polyethylene Tubing	x 3m
7. 4mm Hex Key	x 1
8. UK Mains Power Cable	x 1
9. EU Mains Power Cable	x 1
10. US 230V Mains Power Cable	x 1
11. Genius XE Installation Guide	x 1
12. 1/4" Tee Fitting***	x 1

* x2 in XE 70 Fittings Kit

** x3 in XE 70 Fittings Kit

*** XE 70 Fittings Kit Only

All generator output ports are located on the output panel at the rear of the unit.

Installation

Generator Environment

The generator is designed for indoor use only. It should be installed adjacent to the application(s) it is supplying. If this is not convenient then the unit can be sited elsewhere. Consideration should be made of the lengths of pipe runs as pressure drops can result from extended runs of pipe. See page 21 for guidance on tubing lengths greater than 3m.

Performance of the generator is affected by ambient conditions. Note should also be taken to the proximity of Air Conditioning outlets. These can sometimes give rise to “pockets” of air with high relative humidity. Operation of the unit within such a pocket could adversely affect its performance. Consideration should also be given to the air flow around the unit. **An air gap of 75mm (3”) should be maintained down both sides and 100mm (4”) at the rear of the unit.** Please refer to the drawing opposite for the general dimensions of the unit.

Please ensure generator is situated in a well ventilated environment and is positioned to permit easy disconnection if required.

Minimum Operating Ambient Temperature: 5 °C (41 °F)

Maximum Operating Ambient Temperature: 35 °C (95 °F)

Please note that the generator’s function is primarily to remove Oxygen and Moisture from the generated Nitrogen and/or Dry Air. Depending on model, some hydrocarbon technology may be employed by the generator, in environments with high ambient concentrations of THC additional THC removal filtration may be required, or service life of integrated THC traps may be significantly reduced.

Operation in High Ambient Temperatures

Genius XE generators are designed to supply the rated flow, purity, and pressure in most laboratory environments, however high ambient temperatures can affect the performance of the generator. Output flow capabilities may be restricted in high ambient temperatures, or areas with insufficient air circulation.

Generator Overview

General Dimensions

Genius XE 35

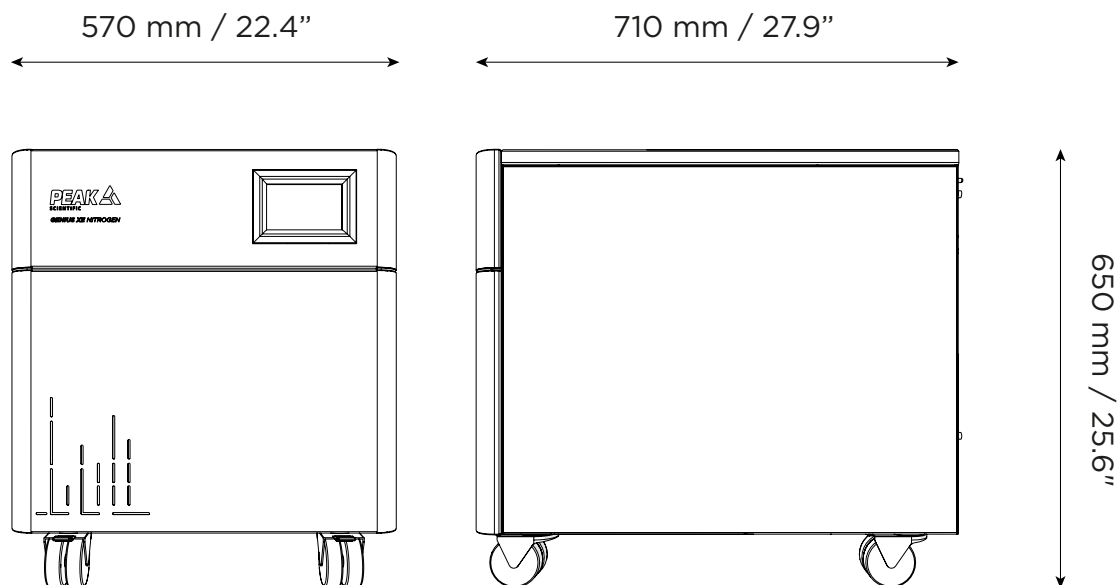

Genius XE 70

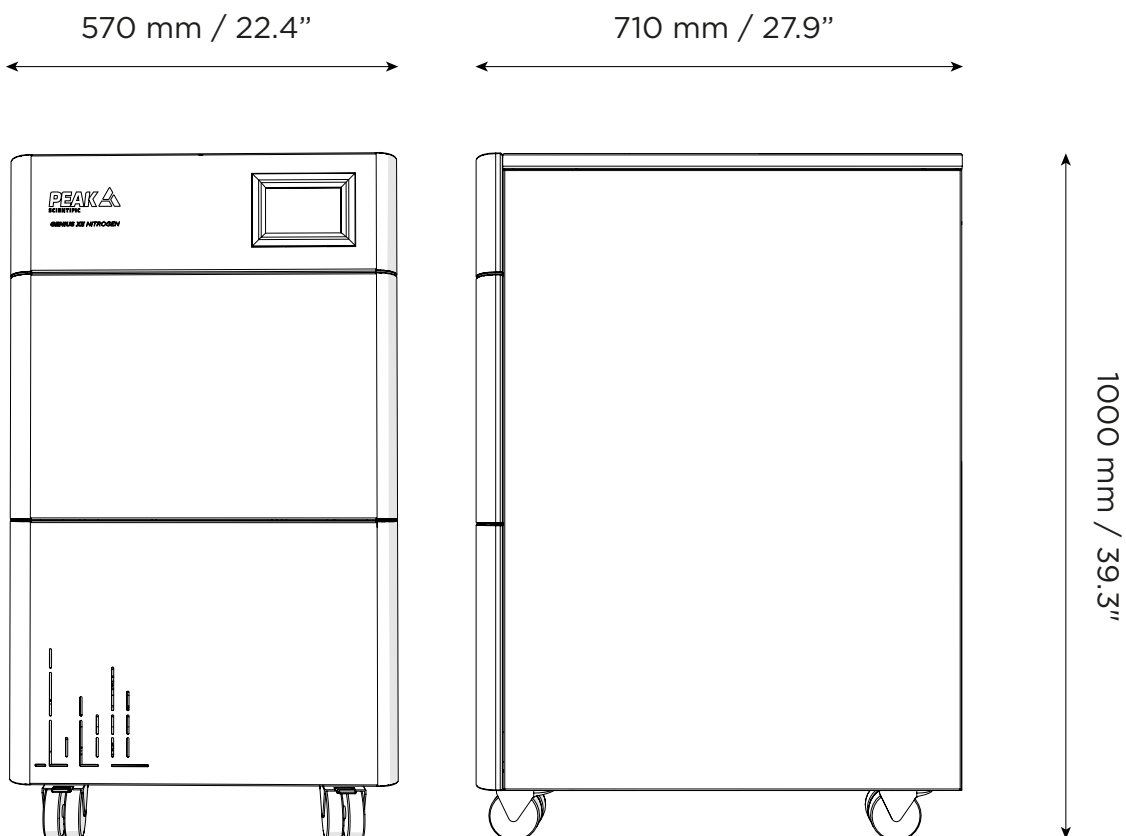

The generator must always be placed on a flat, level surface. Failure to do so will affect the performance of the generator.

Rear Connections

Genius XE 35 & 70

Power Socket

Nitrogen Port

Drain Port

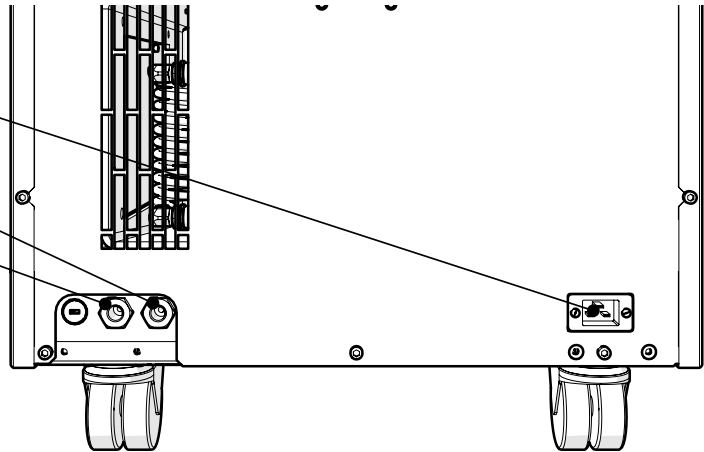

Genius XE 35 (771055721 Serial Numbers onwards)

Power Socket

Nitrogen Port

Drain Port

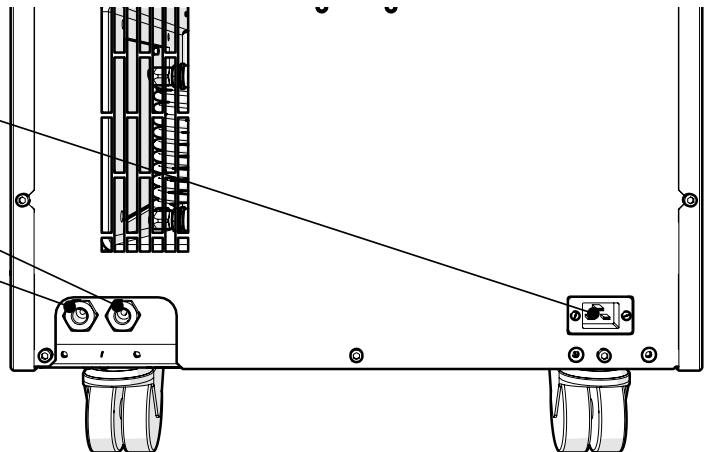

Ensure outlets are connected to correct applications.



Connections should only be carried out by trained personnel

Unit Controls

Touch Screen

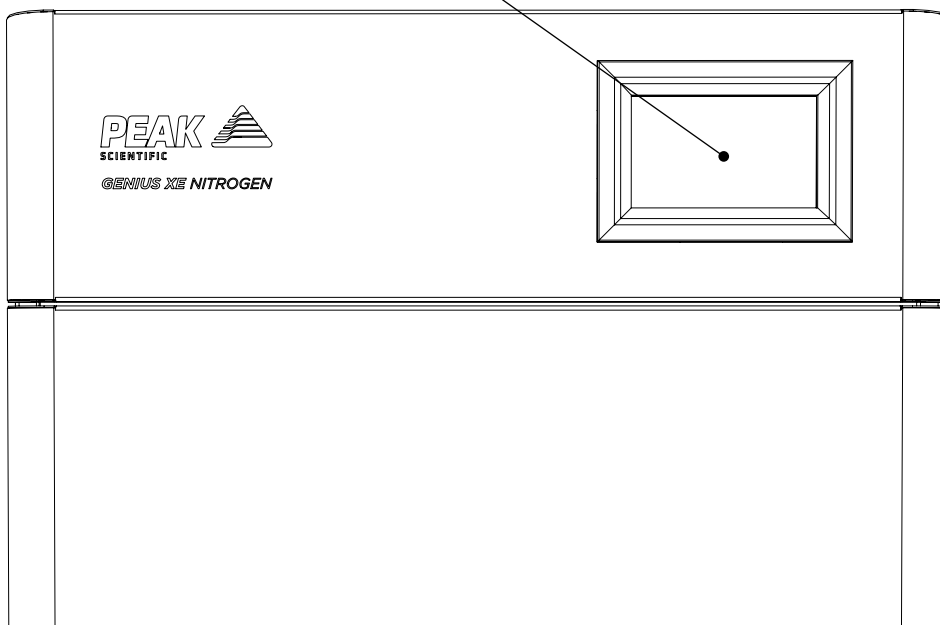

Drain Connection

Fit the 6mm push fit fitting to the drain port at the rear of the unit.

Tighten using a 16mm or 5/8" spanner. Use the 6mm tubing to connect this to a suitable drain connection or container. It should be noted that the generator can expel a considerable amount of water (dependant on ambient humidity).



If a container is used it should be emptied at regular intervals. The container must NOT have an air tight seal as water and air are expelled at pressure. Fix the drain ending of the tube firmly to prevent it from CAUTION vibrating during draining.

Electrical Connection

Connect the generator to an appropriate 120 or 230 volt single-phase supply, refer to the generator serial plate for input specification and ensure your supply matches the requirements.

If the appropriate power cord is not supplied; a new plug, appropriately rated, can be fitted by a qualified electrician.

If a substitute mains supply cord is used, ensure that it has adequate rating. Failure to do so could cause a fire risk.



This unit is classified as SAFETY CLASS 1. THIS UNIT MUST BE EARTHED. Before connecting the unit to the mains supply, please check the information on the serial plate. The mains supply must be of the stated AC voltage and frequency.

EARTH/GROUND (E):-	Green & Yellow	or	Green
LIVE (L):-	Brown	or	Black
Neutral (N):-	Blue	or	White

Electrical requirements are 120VAC nominal +/- 5% or 230VAC nominal +/- 10% depending on chosen model. Extended periods at extremes can have a detrimental effect on the operation and life of the generator.



If the equipment is used in a manner not specified by the manufacturer, the protection provided by the equipment maybe impaired.

The supply voltage will be displayed on the touch screen when the generator is switched on. **If the reading is 219V or less, then we would highly recommend fitting a Dual Tap Transformer 06-3200 (XE 35) or 06-3210 (XE 70). These can be ordered directly from Peak Scientific.**

For Genius XE 35 (120V) voltage should not be less than 114V.

Start-Up Sequence



Before the generator is connected to the application, the generator should be operated in isolation (i.e. not connected to the application) for thirty minutes. This is to ensure any impurities present are purged from the system. Failure to do this may harm the application.

Before connecting the generator to the mains and switching it on for the purge run, it is necessary to fit the silencer to the nitrogen output port

Once this is done, the generator can be connected to the mains and switched on.

The Genius XE will then go through **Product Registration**. This is detailed on the next page.

Continue to operate the generator for a further 30 minutes to allow all the internal pipe-work and storage tanks will have been purged with Nitrogen.

The generator is now purged, the silencers can be removed and the tubes can be connected at the rear of the unit.

Product Registration

Before the generator will start-up for the first time the user must enter a unique 4-digit PIN code.

To receive your generator’s unique PIN code, please register on the Peak website www.peakscientific.com/activate or download the Peak mobile app from the Google Play Store or Apple App Store. A PIN code may also be requested by phoning the Peak helpdesk.

This code is only required on the initial start-up of the unit.

Genius XE 35 Registration

1. Press the 'I've got my pin' button on the screen on the front of the generator.



2. Enter your **PIN**.

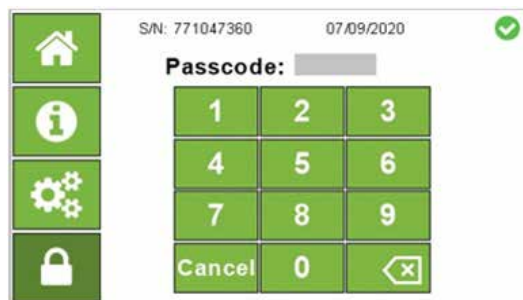

3. **Restart** the unit



4. The unit will then go through **initialisation phase**.

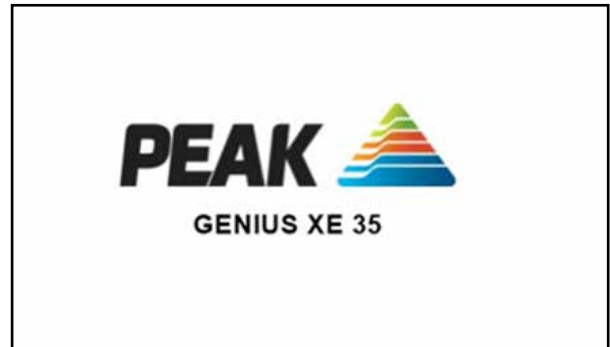

5. Upon completion of the initialisation phase, the screen will display the below, **home screen**.

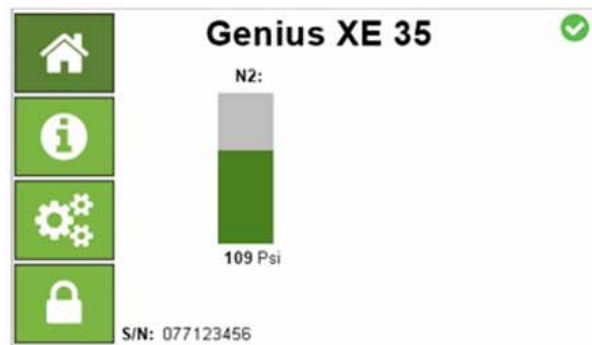

Genius XE 70 Registration

1. Press the 'I've got my pin' button on the screen on the front of the generator.

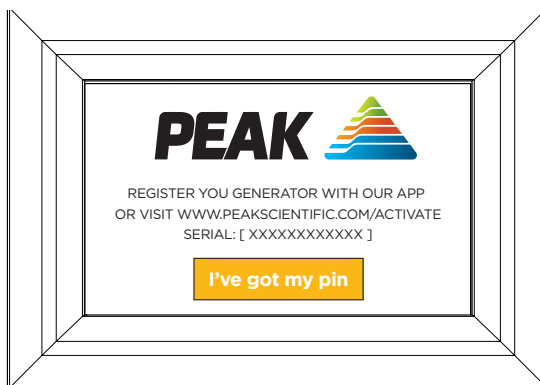

2. Enter your PIN.

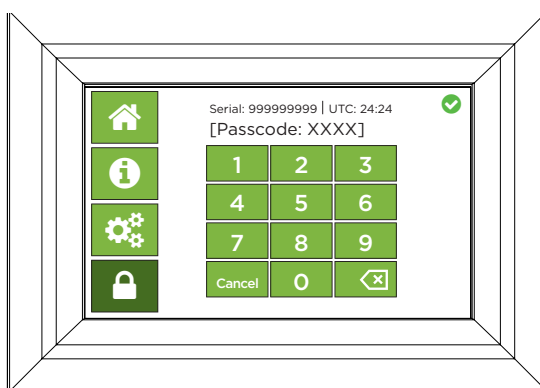

3. The unit will then go through **initialisation**.

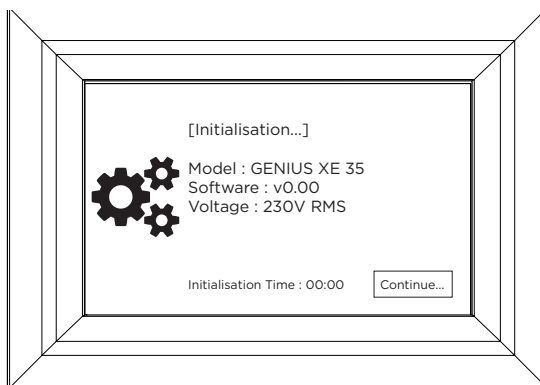

4. Upon completion of the initialisation phase, the screen will display the below, **home screen**.

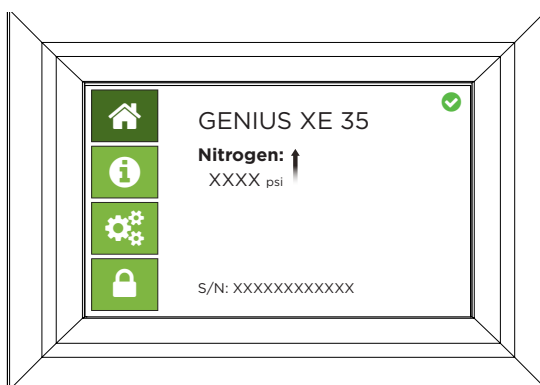

Connecting to the application

Once the initial purge run of 30 minutes has completed, it is ready to be connected to the application(s).



The pressure in the internal storage tanks must be allowed to dissipate before connecting the generator to the application(s). This may be done by leaving the Nitrogen port at the rear of the generator open and turning off the power supply to the generator.

Select the appropriate 1/4" or 6mm fitting from the fittings kit and connect to the generator outlet. Using the appropriate tubing, connect the outlet of the generator to the inlet on the application.

If you require more tubing than is supplied please refer to the Tubing Lengths section.



Once the tubing is connected to the application, please ensure that it is thoroughly checked for being leak-tight. Even the slightest leak in the gas supply between the generator and the application can lead to a drop in Nitrogen purity or insufficient pressure.

Tubing Lengths



The diameter of the tubing which will be connected to the gas outlet is important and is determined by the length of tubing required. Failure to follow these recommendations could lead to excessive pressure drops between generator and application.

- < 3 meters: Use 6mm OD / 4mm ID or 1/4" OD / 3/16" ID PTFE tubing.
- > 3-10 meters: Use 8mm OD / 6mm ID or 5/16" OD / 1/4" ID PTFE tubing. Tubing and fittings not supplied in the fittings kit.
- > 10 - 40 meters: Use 10mm OD / 8mm ID or 3/8" OD / 5/16" ID PTFE tubing. Tubing and fittings not supplied in the fittings kit.
- > 40 metres: Please contact Peak Scientific with the relevant distance and we will calculate the flow resistance and the tubing size required.

Setting the Output Pressure

The output pressure is factory set to 100psi, however; the generator will deliver Nitrogen at the rated flow up to a maximum pressure of 116psi. The output pressure can be adjusted using the pressure regulator at the rear of the generator and viewed on the adjacent gauge.

To ensure a smooth pressure profile, it is not recommended to increase the output pressure above 116 psi.

The pressure gauge in the rear is for indication only and may differ from the reading on the touch screen.

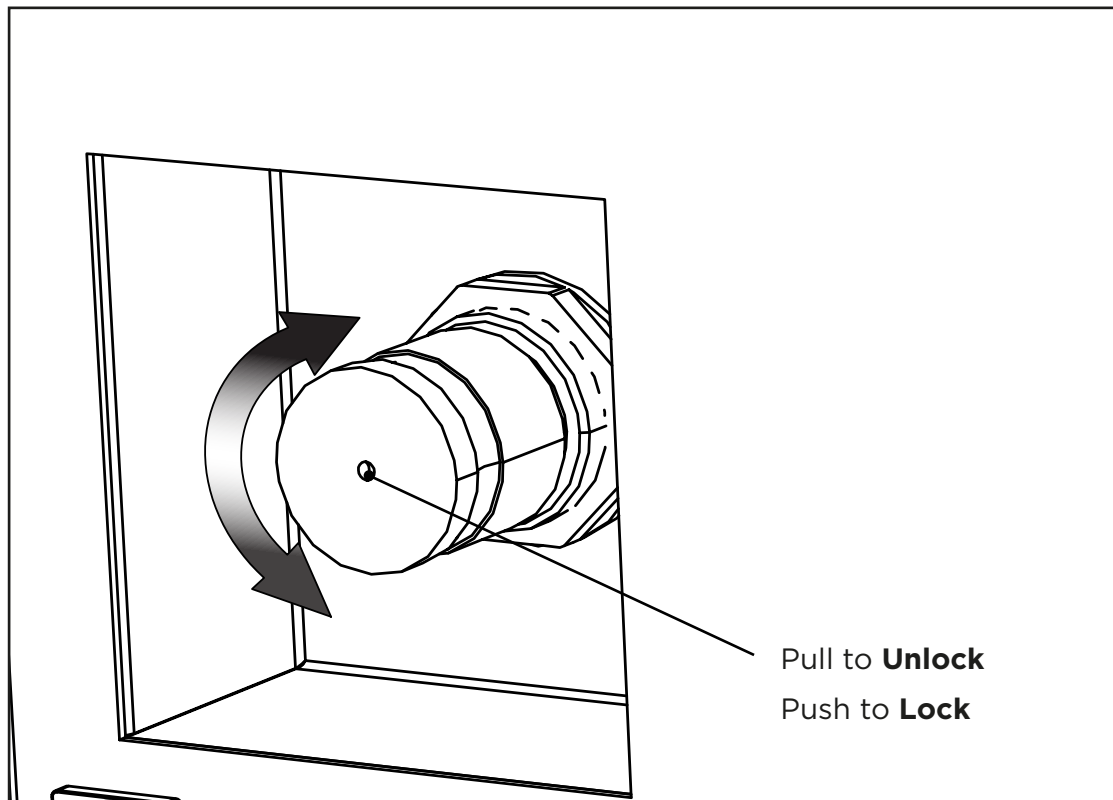

Normal Operation XE 35

Genius XE generators require minimal operator input. So long as the generator is installed as described in earlier sections and is serviced in accordance with the specified maintenance recommendations (see Service Requirements), then it will operate in accordance with the demands of connected applications.

The generator will automatically produce the factory set pressure as detailed in the technical Specifications. The outlet flow rate will vary to satisfy customer demand up to a maximum flow rate in normal operating conditions of 35 LPM.

Genius XE generators are variable-purity systems, and will supply a higher purity of nitrogen at lower flow rates, with a minimum purity of 95% nitrogen at the maximum rated output flow.

If at any time the generator begins to emit excessive noise or vibration, then it should be switched off and you should contact Peak Scientific or the Peak Partner from which the generator has been purchased

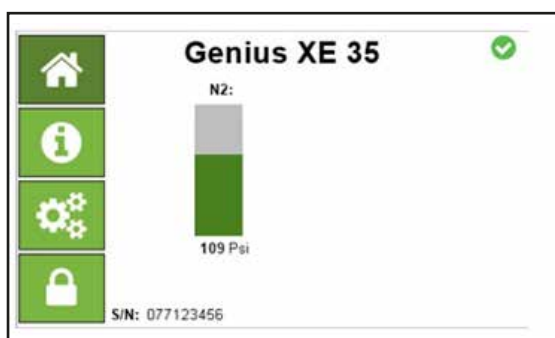

Home Screen

This is the main home screen in normal operation.

Eco Mode

To reduce energy consumption and minimise component wear, Genius XE generators feature a smart “Eco-Mode” which ensures gas is produced as is necessary to satisfy demand.

When demand from the instrument stops the Genius XE generator will stop. If demand from the application starts again, the system will detect the demand for gas and will automatically restart. Additionally, if the flow demand from the generator is below its maximum capacity, the generator will reduce the number of running compressors to the minimum required.

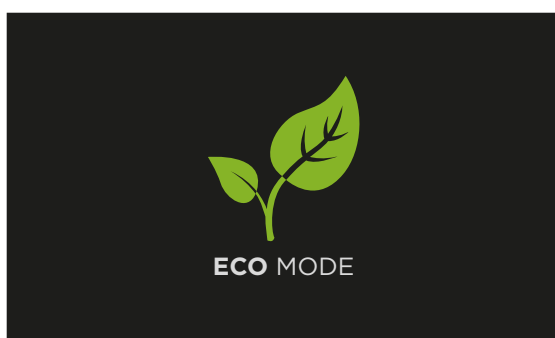

Eco Mode Idle Screen

The Eco Mode Idle Screen is displayed if no system changes occur within a 20 Min period or screen is not touched.

The screen is removed if the system changes or the screen is touched and returns to the relevant home screen.

Service Screens

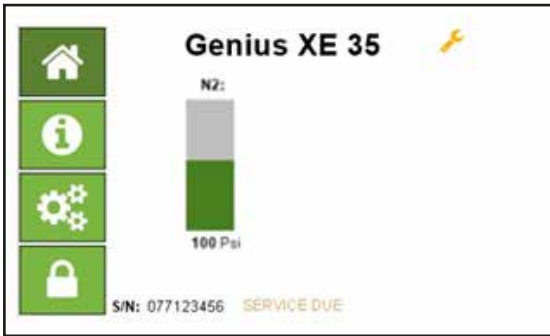

Service Due Home Screen Warning

This is the main home screen when a service is due displaying a yellow service warning.

The screen will alternate between the home screen and a full screen warning as shown next.



Service Due Warning Screen

This is the full screen warning when service is due.

The Confirm button returns the user to the home screen.

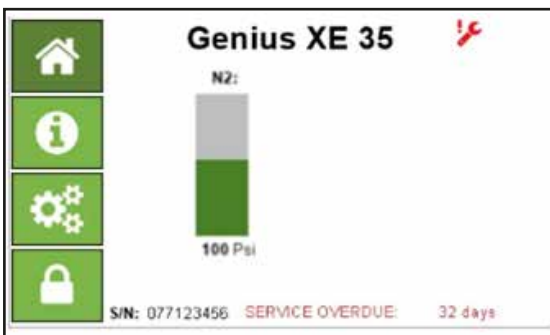

Service Overdue Home Screen Warning

This is the main home screen when a service is overdue displaying a red service warning.

The screen shows the date on which the service was due.

The screen will alternate between the home screen and a full screen warning as shown next.



Service Overdue Warning Screen

This is the full screen warning when service is overdue.

The Confirm button returns the user to the home screen.

Error Screens

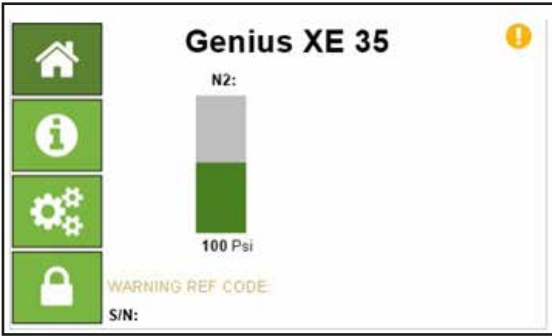

Minor Error Home Screen

This is the main home screen when there is a minor error, displaying a yellow error warning and the error code.

The screen will alternate between the home screen and a full screen warning as shown next.



Minor Error Warning Screen

This is the full screen warning when a minor error has occurred.

The Confirm button returns the user to the home screen.

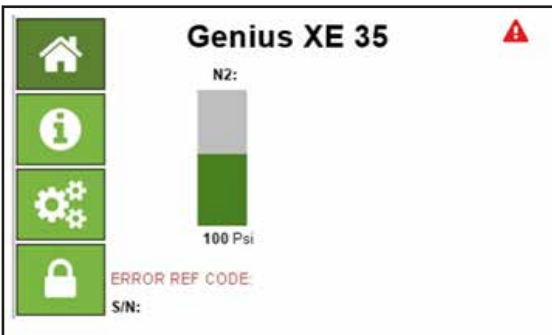

Major Error Home Screen

This is the main home screen when there is a major error, displaying a red error warning and the error code.

The screen will alternate between the home screen and a full screen warning as shown next.



Major Error Warning Screen

This is the full screen warning when a major error has occurred.

The Confirm button returns the user to the home screen.

Information Screens

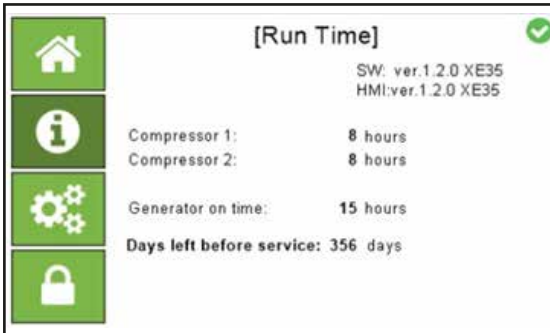

System Info Screen

Displays System Info in an up down navigation scroll.

Settings Screens

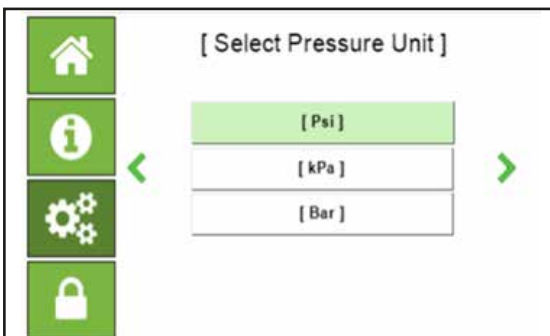

Select Pressure Unit Screen

Allows the user to select a unit of Pressure.

Service Log-in Screen

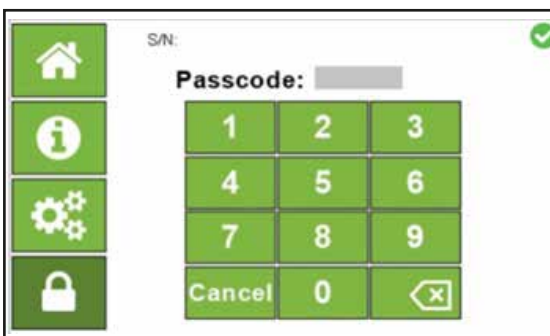

Service Log-in Screen

Allows the Peak Approved Engineer access to the Genius XE's service menus.

Normal Operation XE70

Genius XE generators require minimal operator input. So long as the generator is installed as described in earlier sections and is serviced in accordance with the specified maintenance recommendations (see Service Requirements), then it will operate in accordance with the demands of connected applications.

The generator will automatically produce the factory set pressure as detailed in the technical Specifications. The outlet flow rate will vary to satisfy customer demand up to a maximum flow rate in normal operating conditions of 70 LPM.

Genius XE generators are variable-purity systems, and will supply a higher purity of nitrogen at lower flow rates, with a minimum purity of 95% nitrogen at the maximum rated output flow.

If at any time the generator begins to emit excessive noise or vibration, then it should be switched off and you should contact Peak Scientific or the Peak Partner from which the generator has been purchased

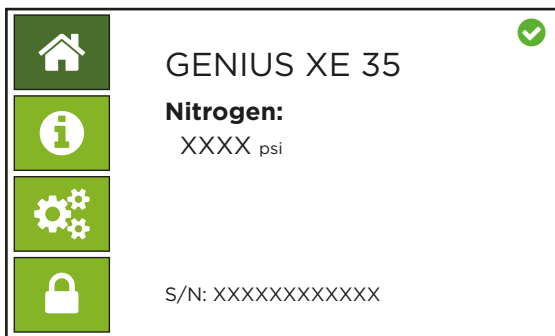

Home Screen

This is the main home screen in normal operation.

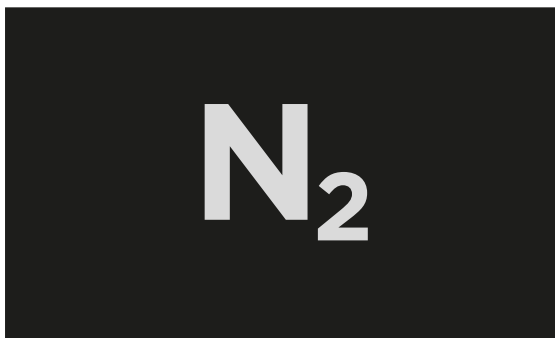

Idle Screen

The Idle Screen is displayed if no system changes occur within a 20 Min period, is not running in Eco mode or screen is not touched.

The screen is removed if the system changes or the screen is touched and returns to the relevant home screen.

Eco Mode

To reduce energy consumption and minimise component wear, Genius XE generators feature a smart “Eco-Mode” which ensures gas is produced as is necessary to satisfy demand.

When demand from the instrument stops the Genius XE generator will stop. If demand from the application starts again, the system will detect the demand for gas and will automatically restart. Additionally, if the flow demand from the generator is below its maximum capacity, the generator will reduce the number of running compressors to the minimum required.

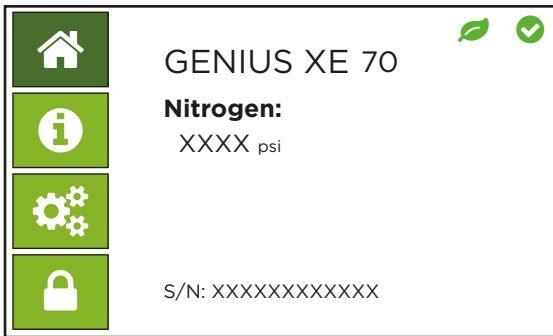

Eco Mode Home Screen

This is the main home screen in Eco Mode.



Eco Mode Idle Screen

The Eco Mode Idle Screen is displayed if no system changes occur within a 20 Min period or screen is not touched.

The screen is removed if the system changes or the screen is touched and returns to the relevant home screen.

Service Screens

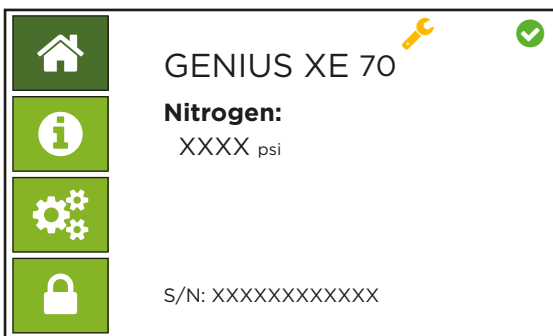

Service Due Home Screen Warning

This is the main home screen when a service is due displaying a yellow service warning.

The screen will alternate between the home screen and a full screen warning as shown next.

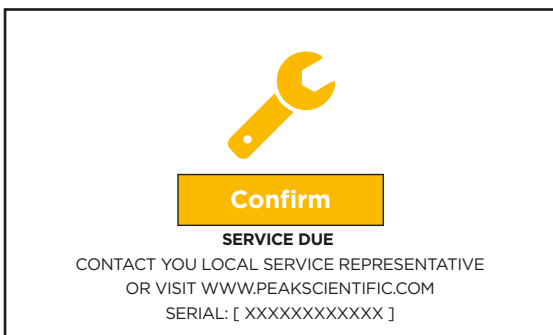

Service Due Warning Screen

This is the full screen warning when service is due.

The Confirm button returns the user to the home screen.

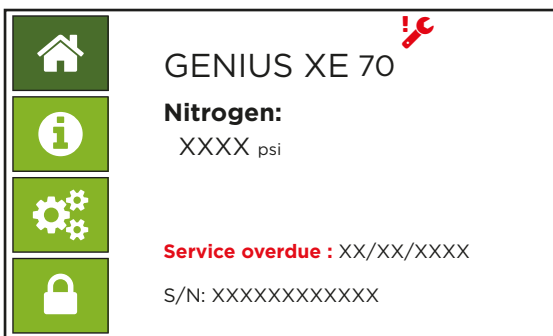

Service Overdue Home Screen Warning

This is the main home screen when a service is overdue displaying a red service warning.

The screen shows the date on which the service was due.

The screen will alternate between the home screen and a full screen warning as shown next.

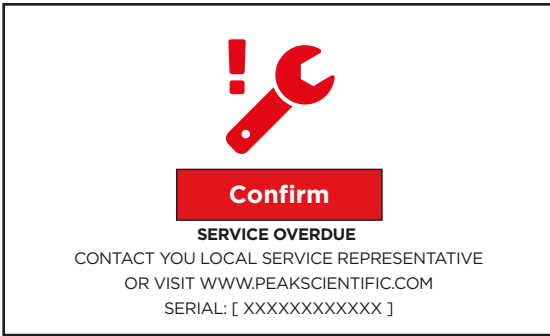

Service Overdue Warning Screen

This is the full screen warning when service is overdue.

The Confirm button returns the user to the home screen.

Error Screens



Minor Error Home Screen

This is the main home screen when there is a minor error, displaying a yellow error warning and the error code.

The screen will alternate between the home screen and a full screen warning as shown next.

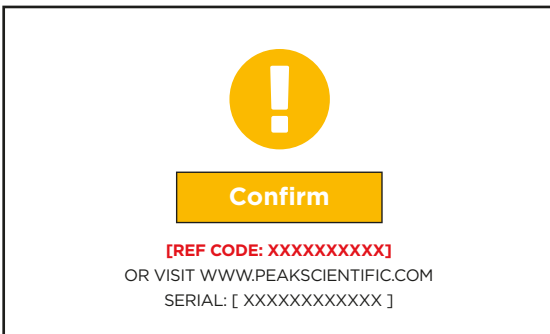

Minor Error Warning Screen

This is the full screen warning when a minor error has occurred.

The Confirm button returns the user to the home screen.

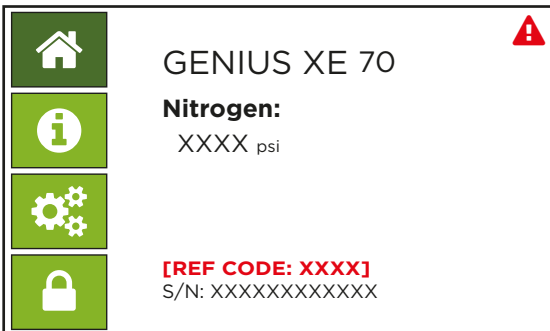

Major Error Home Screen

This is the main home screen when there is a major error, displaying a red error warning and the error code.

The screen will alternate between the home screen and a full screen warning as shown next.



Major Error Warning Screen

This is the full screen warning when a major error has occurred.

The Confirm button returns the user to the home screen.

Information Screens

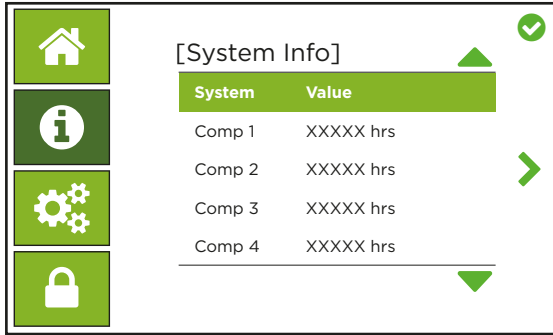

System Info Screen

Displays System Info in an up down navigation scroll.

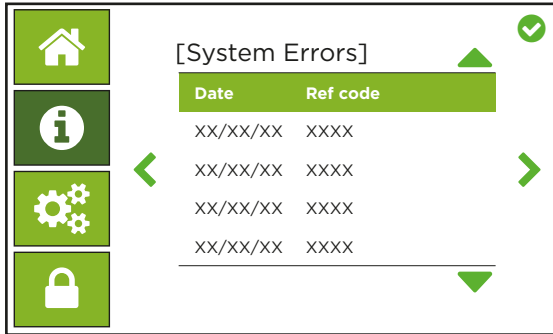

System Error Screen

Displays System Errors in an up down navigation scroll.

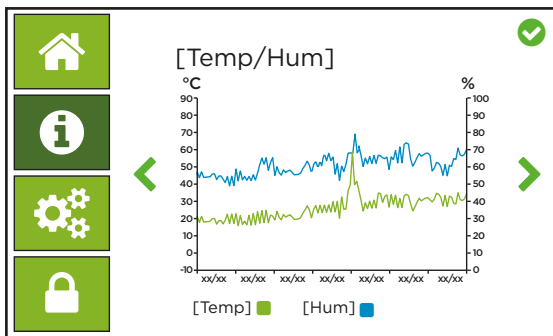

Temperature Graph

2 results plotted: Temperature & Humidity

Y-axis: Left: Temp (selected Unit)

Right: Humidity (%)

X-axis: Time, 7 day rolling dates day/month displayed

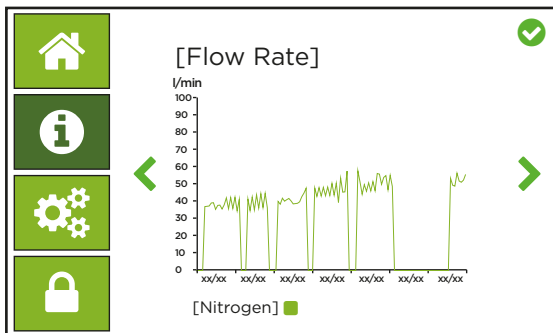

Flow Rate Graph

1 results plotted: Nitrogen

Y-axis: Gas Flow (selected Unit)

X-axis: Time, 7 day rolling dates day/month displayed

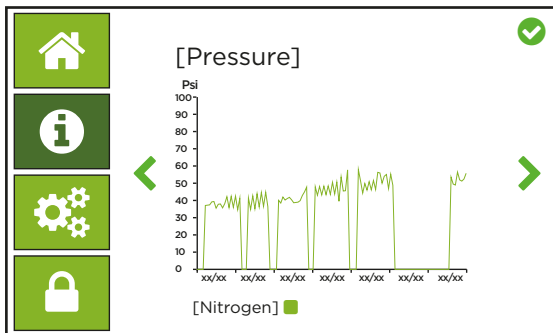

Pressure Graph

1 result plotted: Nitrogen

Y-axis: Gas Pressure (selected Unit)

X-axis: Time, 7 day rolling dates day/month displayed

Settings Screens

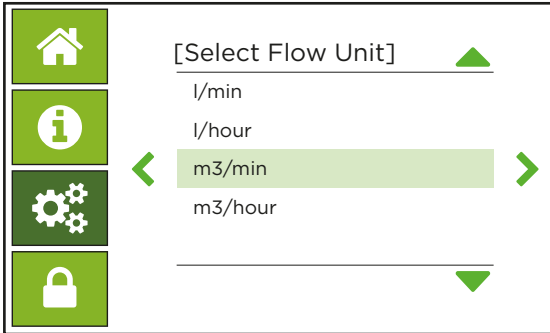

Select Flow Unit Screen

Allows the user to select a unit of Flow.

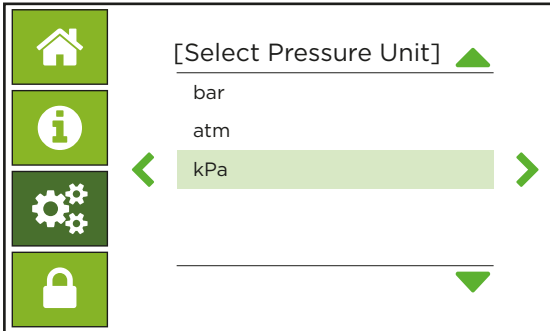

Select Pressure Unit Screen

Allows the user to select a unit of Pressure.

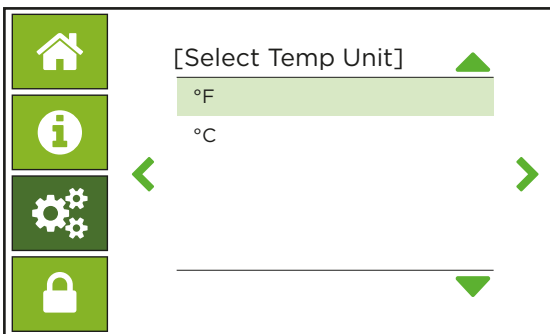

Select Temperature Unit Screen

Allows the user to select a unit of Temperature.

Service Log-in Screen

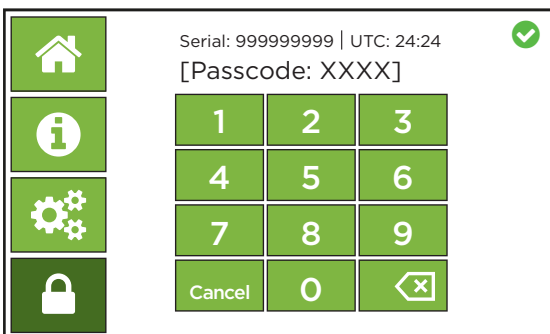

Service Log-in Screen

Allows the Peak Approved Engineer access to the Genius XE's service menus.

Unusual Operation

If at any time the generator begins to emit excessive noise or vibration, then it should be switched off and you should contact Peak Scientific or the Peak Partner from which the generator has been purchased

Service Requirements

Service Schedule

Purchase Interval	Component	Visit	Qty.
12 Months	Genius XE 35 120/230V Annual Maintenance Kit	www.peakscientific.com/ordering	1
	Genius XE 70 230V Annual Maintenance Kit		1
48 Months	Genius XE 35 120V 48 Month Kit		1
	Genius XE 35 230V 48 Month Kit		1
	Genius XE 70 230V 48 Month Kit		1

Service Indication

The generator will notify the user of the service interval for the internal compressors. The generator has the following Service Indication Stages:-

Stage 1

12 months after installation, the service indicator will show on the display along with a warning message.

This is to make the user aware that a service of the generator is due and should be planned at the earliest convenience. The generator will continue to operate as normal with the service indicator on. If the warning message has been acknowledged, the icon will still be displayed in the corner of the HMI; pressing the icon will show the message again.

Stage 2

If the service is not completed the generator will continue to run. After 2 weeks, the service overdue indicator will show on the HMI along with a warning message.

This is to make the user aware that the service of the generator is now overdue and must be completed immediately to ensure the continuous trouble free operation of the generator. If the warning message has been acknowledged, the icon will still be displayed in the corner of the HMI; pressing the icon will show the message again.

Service Indication Reset

Once the service has been completed the Service Indication can be reset through the service interface. This will be performed by the Peak Service Engineer or trained service representative that completes the service operation.

Peak Protected

With Peak Scientific you invest in not only a product but peace of mind. With a network of certified Peak engineers stationed throughout the globe, Peak's rapid response team are never far away and our commitment is to keep your generator running day in, day out, protecting your laboratory workflow.

[Peak Protected] can provide...



Installation
A dedicated Peak engineer will visit your lab to install and setup your generator



Complete plan
Swift response by a Peak Service Engineer within 72 hours & planned preventative maintenance



Premium Protected
Guaranteed rapid on-site response within 24 hours & planned preventative maintenance



IQ/OQ
Certified assurance for applications requiring documented qualification

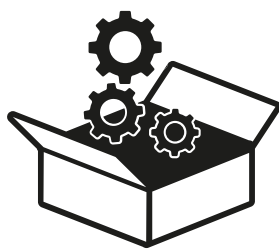

Spares
Genuine Peak parts with express delivery, ensuring optimal performance and lifetime



Technical Support Hotline
Around the clock support by phone or online with our global technical helpdesk

To find out more about protecting your investment visit: www.peakscientific.com/protected

Cleaning

Clean the outside of the generator only using warm soapy water and a clean damp cloth. Ensure all excess fluid is thoroughly removed from the cloth prior to use.



Cleaning should only be undertaken with the power switched off and the power cord removed from the rear of the generator.



CAUTION

Under no circumstances should any solvents or abrasive cleaning solutions be used as these can contain fumes that could be harmful to the generator.



CAUTION

Care should be taken with Leak Detection Liquids.

Alarm Messages

In the event of an alarm condition a message will be displayed on the user interface with a descriptive message and error code.

Please note the displayed error code and contact your service provider.





Minor Alarm Message

There is an issue with the generator but it will continue to supply gas at the required pressure, flow and purity.

Major Alarm Message

There is a problem with the generator that may prevent it from supplying gas at the required pressure, flow or purity. In some instances the generator will automatically shut down to prevent further damage.

Troubleshooting

Problem	Possible Solution
<p>The generator will not switch on and the power switch does not illuminate.</p>	<ul style="list-style-type: none"> • Ensure power cable is plugged into the generator and that the power socket is turned on. • Check the fuse in the power cable plug (if fitted). • Contact your service provider. 
<p>Compressors are running but pressure is not building.</p>	<ul style="list-style-type: none"> • Ensure that the generator is connected to your application and is leak free. • If carrying out the purge run make sure that the flow control silencer is fitted. • Contact your service provider.
<p>The application is reporting low pressure.</p>	<ul style="list-style-type: none"> • Check pressure readings on the display are showing normal pressure. • Ensure that the generator is connected to the application and leak free • Contact your service provider.
<p>Service indicator on the screen is active </p>	<ul style="list-style-type: none"> • The generator is due for service. Contact your service provider. • Refer to Service Indication section of this manual for further information.
<p>Overdue service indicator on the screen is active </p>	<ul style="list-style-type: none"> • The generator is overdue for service. • Contact your service provider urgently. • Refer to Service Indication section of this manual for further information.
<p>Generator displays a minor error code </p>	<ul style="list-style-type: none"> • Ensure ambient temperature and humidity is within specification. • Ensure there are no leaks between the Generator and the mass spec. • Ensure there is an adequate ventilation gap around the back and sides of the generator. • Contact your service provider.
<p>Generator displays a major error code </p>	<ul style="list-style-type: none"> • Ensure there is a complete, leak tight connection between the generator and the application • Ensure the flow demand on the generator is within rated limits. • Contact your service provider.

[**PEAK Protected**]TM

Peak Scientific has highly trained, fully certified Field Service Engineers located in over 20 countries across every continent around the world. This allows us to provide an industry-leading rapid response service to our customers. With [**Peak Protected**], your laboratory's productivity becomes our top priority.

To discuss Peak Protected generator cover and payment options speak to your local Peak Representative or for further information contact: protected@peakscientific.com

Peak Scientific

Fountain Crescent
Inchinnan Business Park
Inchinnan
PA4 9RE
Scotland, UK
Tel: +44 141 812 8100

For further information on any of our generator products please contact marketing@peakscientific.com

