



minipuls® 

Pulse-Free Flow Peristaltic Pump

USER'S GUIDE

TABLE OF CONTENTS

1 - SAFETY	3
Symbols and Notices	3
Intended Use	4
Safety Cover	4
Operating Conditions	4
Solvents	4
Replacement Parts	4
2 - SÉCURITÉ	5
Symboles et avertissements	5
Utilisation prévue	6
Capot de protection	6
Conditions de fonctionnement	6
Solvants	6
Pièces détachées	6
3 - INTRODUCTION	7
Unpacking	7
Customer Service	7
Description	8
4 - SETUP	11
Electrical	11
Install or Change the Pump Head	12
Tubing - Selection and Fitting	13
Safety Cover Installation	16
Recommendations	19
Gilson Connectors and Couplers	19
5 - OPERATION	21
Keypad Functions	21
Initialization	21
Autostart Function	22
Maintenance and Troubleshooting	24
6 - REMOTE CONTROL	26
Electrical Contact Control	26
Control by Gilson Devices	27
GSIOC Control	27
7 - APPENDIX	33
Part Numbers	33
Standard Accessory Package	33
Additional Accessories	34
Technical Specifications	37

1 - SAFETY

Read this section before installing and operating the pump.

Symbols and Notices

The following internationally recognized electronic and hazard symbols may appear on the instrument:

Symbol	Explanation		
	Direct current	Courant continu	Gleichstrom
	Protective conductor terminal	Borne de terre de protection	Schutzleiteranschluss
	Electrical power ON	Sous tension	Netzschalter ein
	Electrical power OFF	Hors tension	Netzschalter aus
	Caution	Attention	Vorsicht
	Mechanical hazard	Danger mécanique	Mechanische Gefährdung

The following safety notices may appear in this document:

	WARNING	WARNING indicates a potentially hazardous situation which, if not avoided, may result in serious injury
	CAUTION	CAUTION indicates a potentially hazardous situation which, if not avoided, may result in minor or moderate injury
	NOTICE	NOTICE indicates a potentially hazardous situation which, if not avoided, may result in equipment damage

Intended Use

The pump is intended to be used in the laboratory, or similar indoor environment, by trained technical personnel.

CAUTION The instrument must not be directly connected to humans for any purpose.

For safe and proper use of this instrument, it is required that both operating and service personnel follow the instructions contained in this guide when installing, cleaning, and maintaining the instrument.

The following safety precautions must be observed during all phases of operation, service, and repair of the instrument. Failure to comply with these precautions or with specific warnings elsewhere in this user's guide violates safety standards of design, manufacture, and intended use of the instrument. Gilson assumes no liability for the customer's failure to comply with these requirements.

The MINIPULS 3 Peristaltic Pump has been certified to safety standards required in Canada, Europe, and the United States. Refer to the instrument rear panel label and the Declaration of Conformity document for the current standards to which the instrument has been found compliant.

Safety Cover

A safety cover is installed on each pump head.

The safety cover protects the user from the mechanical hazard present when the pump head is rotating.

Do not operate the pump without the safety cover installed.

R2 Pump Head with Installed Safety Cover



Operating Conditions

Access to the rear panel is necessary because the instrument must be detached from all voltage sources before service, repair, or exchange of parts. Allow a minimum of 2.54 cm (1 in.) space behind the instrument for proper fan operation.

Operate the instrument using the approved power supply provided and only at the voltage specified on the rear panel label of the instrument.

Solvents

Observe safe laboratory practices when handling solvents. If dangerous liquids are used, adequate protection such as proper ventilation, safety glasses, etc., should be used. Refer to the Material Safety Data Sheets for the solvents before use.

Replacement Parts

Be sure to use only replacement parts specified in this user's guide. Do not repair or change parts which are not listed in this user's guide. If it is necessary to change parts not listed, please contact your local Gilson representative.

2 - SÉCURITÉ

Merci de lire ces instructions avant toute installation ou utilisation de MINIPULS 3.

Symboles et avertissements

Les symboles suivants sont susceptibles d'apparaître sur l'instrument:

Symbole	Signification		
	Direct current	Courant continu	Gleichstrom
	Protective conductor terminal	Borne de terre de protection	Schutzleiteranschluss
	Electrical power ON	Sous tension	Netzschalter ein
	Electrical power OFF	Hors tension	Netzschalter aus
	Caution	Attention	Vorsicht
	Mechanical hazard	Danger mécanique	Mechanische Gefährdung

Les consignes de sécurité suivantes peuvent apparaître dans ce document:

	WARNING	AVERTISSEMENT signale une situation potentiellement dangereuse qui, si elle n'est pas évitée, peut entraîner des blessures graves
	CAUTION	ATTENTION signale une situation potentiellement dangereuse qui, si elle n'est pas évitée, peut entraîner des blessures mineures ou légères
	NOTICE	AVIS signale une situation potentiellement dangereuse qui, si elle n'est pas évitée, peut entraîner des dommages matériels

Utilisation prévue

Cet instrument est destiné à être utilisé dans un environnement de laboratoire, par un personnel technique qualifié.

⚠ CAUTION L'instrument ne doit en aucun cas être relié directement au corps humain.

Pour une utilisation correcte et en toute sécurité, il est nécessaire que le personnel qui utilise et réalise la maintenance de l'instrument, suive les instructions contenues dans ce guide lors de l'installation, le nettoyage et la maintenance de l'instrument.

Les consignes de sécurité suivantes doivent être respectées durant toutes les phases de fonctionnement, d'entretien ou de réparation de l'instrument. Le non-respect de ces précautions ou des avertissements spécifiques mentionnés dans ce guide compromet les normes de sécurité de conception, de fabrication et d'utilisation prévue de l'instrument. Gilson décline toute responsabilité en cas d'incapacité du client à se conformer à ces exigences.

MINIPULS 3 a été certifiée conformément aux normes de sécurité en vigueur au Canada, en Europe et aux Etats-Unis. Merci de vous reporter aux indications mentionnées sur le panneau arrière de l'instrument ainsi qu'au document de Déclaration de Conformité aux normes pour lesquelles l'instrument a été déclaré conforme.

Capot de protection

Un capot de protection est installé sur chaque tête de pompe.

Il protège l'utilisateur des risques mécaniques présents dès lors que la tête de pompe tourne.

Ne pas faire fonctionner la pompe sans son capot de protection.

Tête de pompe R2 équipée de son capot de protection

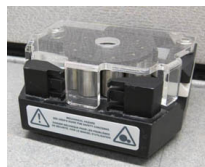

Conditions de fonctionnement

L'accès au panneau arrière doit être libre car l'instrument doit pouvoir être déconnecté de sa source d'alimentation avant toute opération d'entretien, de réparation ou de remplacement de pièces.

Ne faites fonctionner l'appareil qu'en utilisant le bloc d'alimentation fourni et uniquement à la tension indiquée sur l'étiquette située à l'arrière de l'instrument.

Solvants

Respectez les Bonnes Pratiques de Laboratoire lors de la manipulation de solvants. Si des liquides dangereux sont utilisés, assurez-vous que la ventilation est adéquate et portez en permanence un équipement de protection individuelle (EPI), tel que : lunettes, gants et vêtements de protection.

Reportez-vous aux Fiches de Données de Sécurité pour les solvants avant toute utilisation.

Pièces détachées

Assurez-vous de n'utiliser exclusivement que les pièces détachées préconisées dans ce guide. Ne tentez pas de réparer ou remplacer des pièces ne figurant pas dans ce guide.

Si le remplacement de pièces ne figurant pas dans ce guide s'avérait nécessaire, merci de contacter votre représentant Gilson local.

3 - INTRODUCTION

Gilson's MINIPULS 3 Peristaltic Pump was specifically designed to meet process laboratory liquid handling needs. The MINIPULS 3 combines microprocessor speed control with a high-torque stepper motor. Chemical-resistant pump heads, equipped with 5 or 10 stainless steel rollers, set the performance standard in producing smooth, low-pulse flow and reproducible flow rates at higher pressures.

This user's guide describes how to set up and operate a Gilson MINIPULS 3 Peristaltic Pump. It also describes some of the methodology required to obtain accurate reproducible results.

Unpacking

Upon receipt of your MINIPULS 3, unpack it and check that all of the parts are included even if it is not for immediate use. Report any loss or damage immediately. Keep the original packaging in case the MINIPULS 3 must be returned to the factory.

After unpacking the box, you should have the following:

- ▶ speed control module
- ▶ standard accessory package
- ▶ external power supply
- ▶ documentation

A pump head is required, but ordered separately.

Customer Service

Gilson, Inc. and its worldwide network of authorized representatives provide customers with the following types of assistance: sales, technical support, applications, and instrument repair.

If you need assistance, please contact your local Gilson representative. Specific contact information can be found at www.gilson.com. To help us serve you quickly and efficiently, please refer to **Before Calling Us** on page 25.

Description

Gilson's MINIPULS 3 is a peristaltic pump, designed for transferring fluids with a high level of speed stability and a low pulsation level. It has many applications, including the following:

- ▶ transferring solutions, emulsions, suspensions, and gases at up to 200°C.
- ▶ pumping liquids through chromatographic systems against a back pressure of up to 0.5 MPa (72.5 psi) when controlled by a Gilson fraction collector, for example.
- ▶ automation of biological analyses by proportionally mixing a sample with several reagents (flow injection analysis).
- ▶ continuously sampling the components of a production process (reactors, fermenters, etc.).
- ▶ formation of gradients (concentration, pH, etc.).

Control of the MINIPULS 3 is from a computer via GSIOC and Gilson TRILUTION LH software, remote control by contact closure, or manual control by front panel operation.

Speed Control Module

The figure shows a general view of a MINIPULS 3, before the head is installed.

Front Panel

The front panel consists of:

- ▶ a keypad
 - ▶ a display
- 1 **Slower** Decrease the pump speed
 - 2 **Faster** Increase the pump speed
 - 3 **Rabbit** Set speed to 48 rpm for priming
 - 4 **Forwards** Start the pump clockwise
 - 5 **Backwards** Start the pump counter-clockwise
 - 6 **Stop** Stop the pump



Rear Panel

The rear panel consists of:

- ▶ a power on/off switch
- ▶ a DC input
- ▶ a fan
- ▶ a contact input port
- ▶ a 9-pin GSIOC port
- ▶ a USB device port (for service use only)

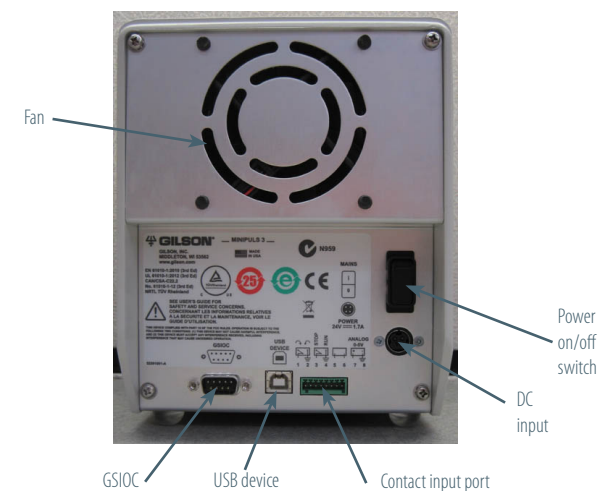

Pump Head with Safety Cover

Pump heads are composed of a rotor with idle stainless steel rollers that press a flexible piece of tubing against a cam. In this way liquids are pumped by a peristaltic effect.

There are two types of pump heads: the **MP** (standard) and the **HF** (High Flow) series.

- ▶ MP models have one, two, four, or eight channels (R1, R2, R4, and R8), ten rollers, and accept tubing size from 0.2 mm to 4 mm (internal diameter). The maximum back pressure is 0.5 MPa (72.5 psi).
- ▶ HF models have two or four channels (R2/HF and R4/HF), five rollers, and accept peristaltic tubing from 2 mm to 8 mm (because of the V-clamp locking system). The maximum back pressure is 0.3 MPa (43.5 psi).

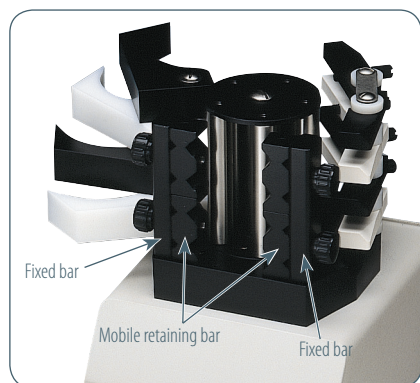
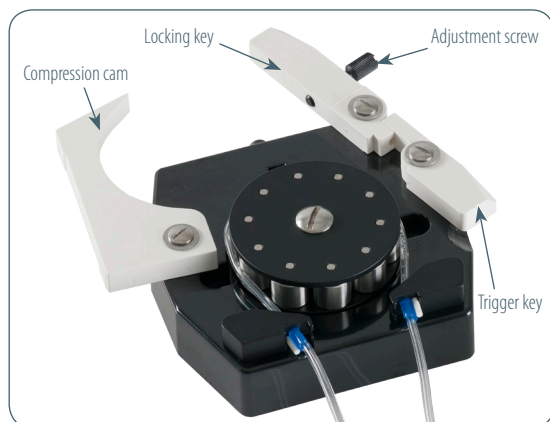

Note: The images above and at left are shown without safety covers for clarity.

R1 Pump Head



R2 Pump Head



R8 Pump Head



R4 Pump Head



R2/HF Pump Head



R4/HF Pump Head



4 - SETUP

This chapter contains detailed information relating to fitting the tubing, flow rate selection, and which connectors or couplings should be used.

Electrical

Remote Control Connections

Electrical Contacts

The MINIPULS 3 can be started and stopped remotely using electrical inputs. The direction of rotation and pump speed may also be changed. The electrical contacts are made using the terminal block on the rear panel. The contacts, which are numbered 1 through 8, have the functions listed below. Contacts 2, 4, and 8 are ground connections.

- ▶ Pair 1-2 is a contact input that changes the pumping direction.
- ▶ Pair 3-4 is a contact input that starts/stops the pump.
- ▶ Pair 5-6 is not used.
- ▶ Pair 7-8 controls the speed of the pump using an analog voltage signal. For more information, refer to **Pump Speed (Analog Input)** on page 26.

Making Connections

The following are needed to make connections:

- ▶ 2-conductor cable (20–26 gauge for each wire)
- ▶ wire insulation stripper

A 6-foot piece of suitable cable (part number 709910206) is available for purchase from Gilson.

To make connections with the 2-conductor cable:

- 1 Cut the cable into pieces of appropriate length.
- 2 Strip about 8 mm of insulation from each end of the cable.
- 3 Remove the terminal block connector from the pump.
- 4 Press in the spring-loaded retainer for the appropriate terminal on the terminal block connector. Insert each wire into the appropriate terminal on the terminal block connector and then release the spring-loaded retainer.
- 5 Reconnect the terminal block connector to the liquid handler. Push the connector in as far as it will go. It is designed to fit snugly into its receptacle.
- 6 Connect the opposite ends of the wires to the other device(s). Be sure to match ground connections.
- 7 Label each cable to identify the purpose of the connection.

Computer Control

To control the MINIPULS 3 from a computer, connect an appropriate Gilson interface module, or a Gilson RS-232 adapter to the computer.

Next, connect a Gilson Serial Input/Output Channel (GSIOC) cable between the interface module (or adapter) and the MINIPULS 3, and any other Gilson devices that are controlled from the same computer.

The 9-position female plug on the GSIOC cable connects directly into the male socket on the MINIPULS 3 rear panel.

The type of interface module used, and details of how the various units in the system are interconnected, depend on the complexity of the system.

Refer to the appropriate user's guide, and to **6 - REMOTE CONTROL** beginning on page 26, for more details relating to GSIOC connections and commands.

Install or Change the Pump Head

Follow these procedures to install or replace a pump head.

CAUTION The safety cover must be installed on the pump head before operating the pump. Failure to do so presents a mechanical hazard to the user. Safety cover installation instructions are provided on page 16.

Remove Cover

- 1 Unscrew the two screws securing the cover to the pump head until the cover can be lifted off the pump head.
- 2 Lift the cover off the pump head.

Open Pump Head

- 1 Unlock each channel of the head by pressing the trigger key towards the roller barrel.
- 2 Swing the compression cam out.

Install Pump Head

- 1 Place the two mounting screws (part number 4011564204, supplied in the accessory kit) through the pump head.
- 2 Install the pump head on top of the speed control module in the desired position; four are possible. Do not position it with the drain tube to the front.
- 3 Turn the roller shaft so that the slot at the bottom of the shaft aligns with the tab of the rubber coupler in the speed control module. Turning the shaft gently back and forth can help the user to engage it with the tab. When these two parts are properly engaged, the base of the pump head rests on top of the speed control module.
- 4 Slide the pump head so that the two screws fall into their inserts and then tighten the screws, but do not over-tighten.

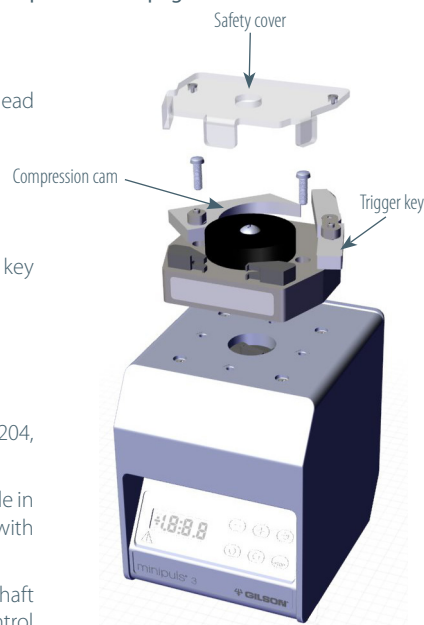

Tubing - Selection and Fitting

Introduction

There is a small Iso-Versinic® drain tube inside the MINIPULS 3, with an outlet at the base of the pump. The tube, which limits the risks resulting from a rupture of the peristaltic tubing, is connected to the motor assembly to prevent liquid from seeping inside the instrument.

All other tubing is fitted to the pump head. Gilson supplies two types of tubing:

- ▶ peristaltic tubing with two retaining stops,
- ▶ connection tubing without retaining stops.



In normal operations, short lengths of peristaltic tubing are placed in the pump head. With MP pump heads, it is essential that peristaltic tubing with two retaining stops is used. The calibrated stops ensure that the tubing is correctly tensioned when fitted to the head.

HF models can use either type of tubing. The user then links the MINIPULS 3 with other hydraulic components of the system (for example chromatographic columns) using connection tubing, connectors, and couplers of appropriate diameter and material.

Type of Material

Tubing made of various materials and with different internal diameters is available from Gilson. The tubing sizes and materials, recommended for MP and HF pump heads are shown in the table. Tubing sizes are specified as internal diameter (ID) in millimeters (mm). Maximum flow rates are specified in milliliters/minute.

Recommended Tubing (by Flow Rate)

Type	MP Models		HF Models	
	Flow mL/min	Connecting mm (ID)	Flow mL/min	Connecting mm (ID)
PVC	up to 26	0.25 to 3.2	up to 236	2 to 8
Fluoroelastomer	up to 38	0.5 to 4	-	2 to 6
Silicone	up to 45	0.6 to 2.8	up to 200	2 to 7
Polypropylene	up to 14	0.5 to 2	up to 171	2 to 6.4

For any given type of pump head, the type of solution pumped determines the type of peristaltic tubing to be used. For more information, refer to **Recommended Tubing (by Application)** on page 14.

More rigid materials, such as PVC, produce smaller pulsations. For example, when pumping water at 45 rpm (pressure = 0.1 MPa or 14.5 psi) typical values for pressure pulsations are 5% with 6 mm (ID) PVC tubing and 20% with 6 mm (ID) silicone tubing.

Diameter and Flow Rate

Select the peristaltic tubing diameter that gives the desired flow rate after referring to **Flow Rate Selection and Adjustment** on page 16. These graphs represent the values obtained in laboratory tests, where the liquid was allowed to flow freely from the tubing against atmospheric pressure only. There was no additional back pressure (e.g., a chromatographic column).

The selection of peristaltic tubing is a compromise between minimizing the pulsations and maximizing the lifetime of the tubing. When making this choice, the following points should be considered:

- ▶ the smaller the diameter, the smaller the pulsations and the faster the head has to rotate, leading to a reduction of peristaltic tubing lifetime
- ▶ the bigger the diameter, the bigger the pulsations, and the slower the head has to rotate, leading to increased peristaltic tubing lifetime. That is, the pulsations increase when the flow rate decreases, and when the internal diameter of the tubing increases.

Recommended Tubing (by Application)

Material	PVC	Silicone	Polypropylene	Iso-Versinic® (Viton®)
Composition	Polyvinyl chloride	Silicone elastomer	Polypropylene-based material with plasticizer	Fluorinated elastomer
Physical characteristics	Transparent, clear, rigid	Translucent, beige	Opaque, beige	Opaque, black
Temperature range	Up to 94°C	Up to 230°C	-60 to 135°C	-20 to 200°C
Standard			FDA food quality (FDA 21 CFR 177.26000 USP class VI)	
Gas permeability	Low	High	Low	Impermeable to most gases
Sterilization	Autoclaving	Autoclaving or irradiation	Autoclaving	Autoclaving
Range of internal diameter	0.25 to 8 mm	0.64 to 7 mm	0.5 to 6.4 mm	0.5 to 6.0 mm
Other features	Low cost	Excellent biocompatibility Not recommended with strong acids, bases or solvents	Long service life	Excellent resistance to strong acids, oxidizing agents, aromatic and chlorinated solvents
Applications	General use	Biological	Pharmaceutical and food	Where high chemical resistance is required (e.g., ICP)

Fitting the Tubing

Before fitting the tubing, remove the safety cover. Install the safety cover before operating the pump.

MP Pump Heads

Only peristaltic tubing with retaining stops can be fitted to MP pump heads.

- 1 Unlock each channel of the head by pressing the trigger key (A) towards the roller barrel.
- 2 Position the tubing around the rollers; it is kept in place by the plastic stops (B).
- 3 Swing the compression cam back and snap the locking key. Do this one-by-one for pump heads with more than one channel.

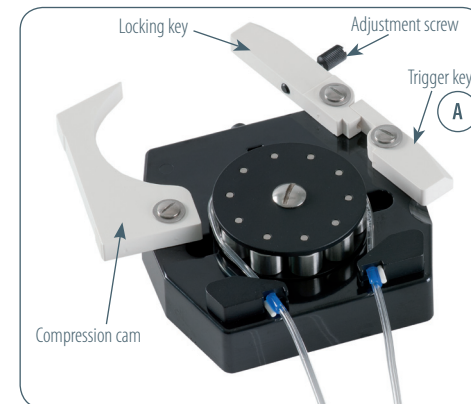

HF Pump Heads

Peristaltic Tubing with Retaining Stops:

- 1 Unlock each channel of the head by pressing the trigger key (A) towards the roller barrel.
- 2 Position the tubing around the rollers; they are kept in place by the plastic stops (B).
- 3 One by one, swing the compression cams back and close the locking keys.



Peristaltic Tubing without Retaining Stops:

The peristaltic tubing is kept in place by clamps. The movable retaining bar (C) must be fitted in such a way that the large triangular pathways are on the side of the fixed bar. To fit the tubing, use the same procedure as above.

Because the R2/HF and R4/HF pumps are equipped with 5 rollers rather than the 10 rollers as on the other heads, pulsations may be observed at the end of the tubing.

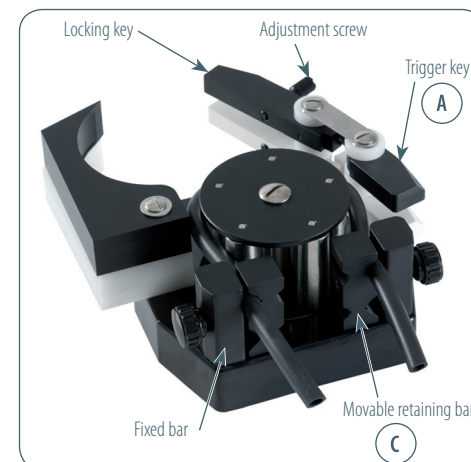

Safety Cover Installation

- 1 Place the cover.
- 2 Align the screws with their inserts as shown in the image at right.
- 3 Tighten the screws.

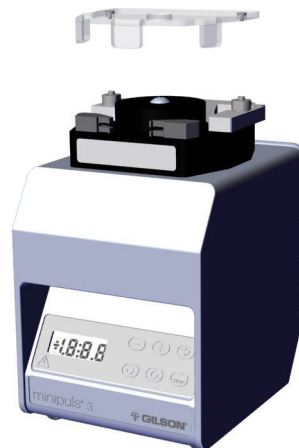

Flow Rate Selection and Adjustment

Selection

The following charts may be used to select the approximate pump head speed (rpm) that is required to achieve the desired flow rate.

If it is possible to choose between tubings of different sizes (refer to the 7 - APPENDIX beginning on page 33), select a middle range tubing that gives a middle range speed.

Adjustment

Adjust the cam pressure on the tubing to the minimum necessary to ensure pumping of the liquid. The compression cam pressure can be adjusted using the adjustment screw.

Slowly tighten the screw until the pump starts pumping liquid inside the peristaltic tubing, and then tighten again approximately 1/8 turn. Take care not to over-tighten the screws; it is advisable to limit pressure on tubing to the minimum necessary for pumping liquid. Carry out final adjustment after 15 minutes of operation.

If the pump is used with a system that provides a back pressure (e.g., a chromatographic column), tighten the screw by one or two extra turns to obtain the required flow rate.

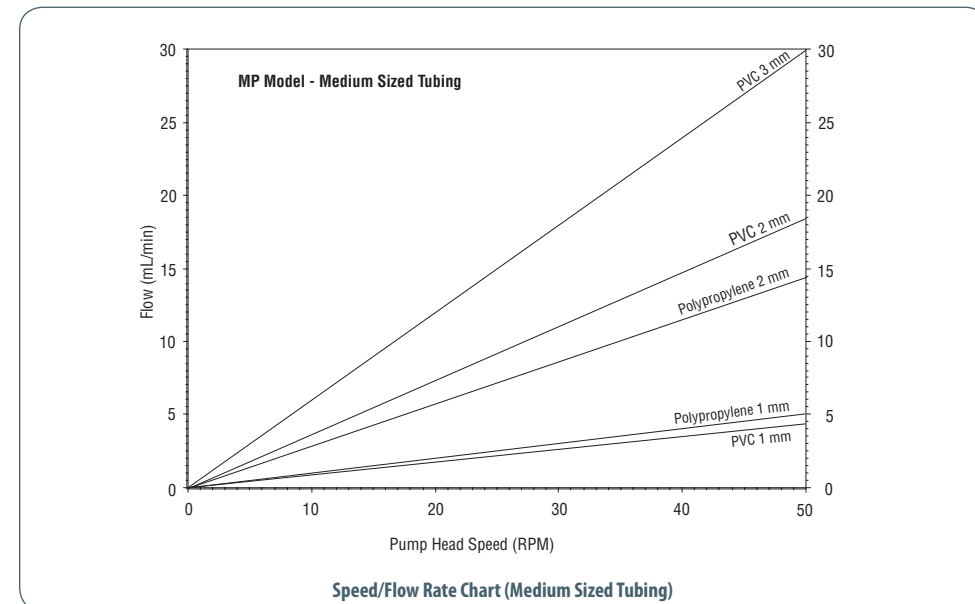

Speed/Flow Rate Chart (Medium Sized Tubing)

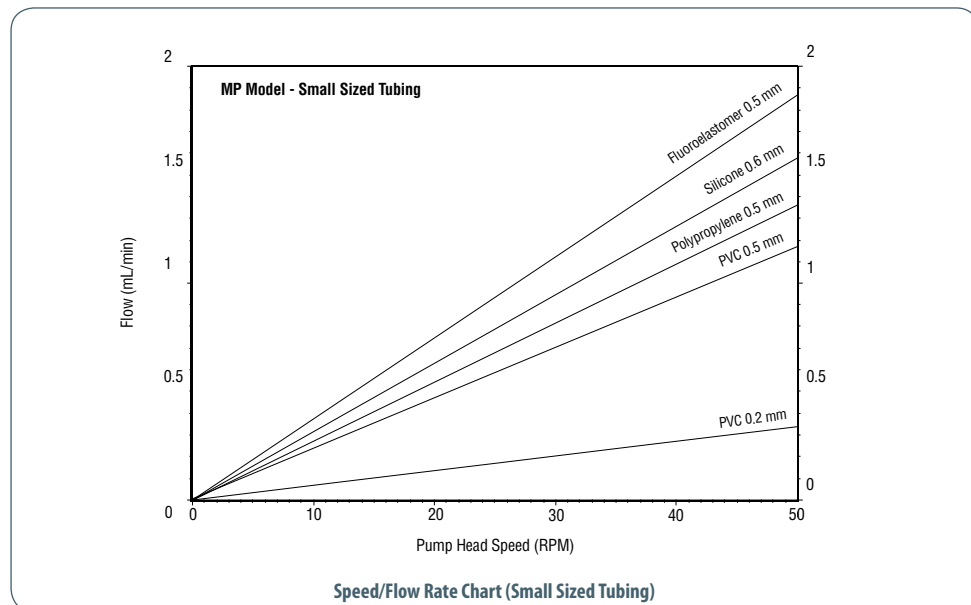

Speed/Flow Rate Chart (Small Sized Tubing)

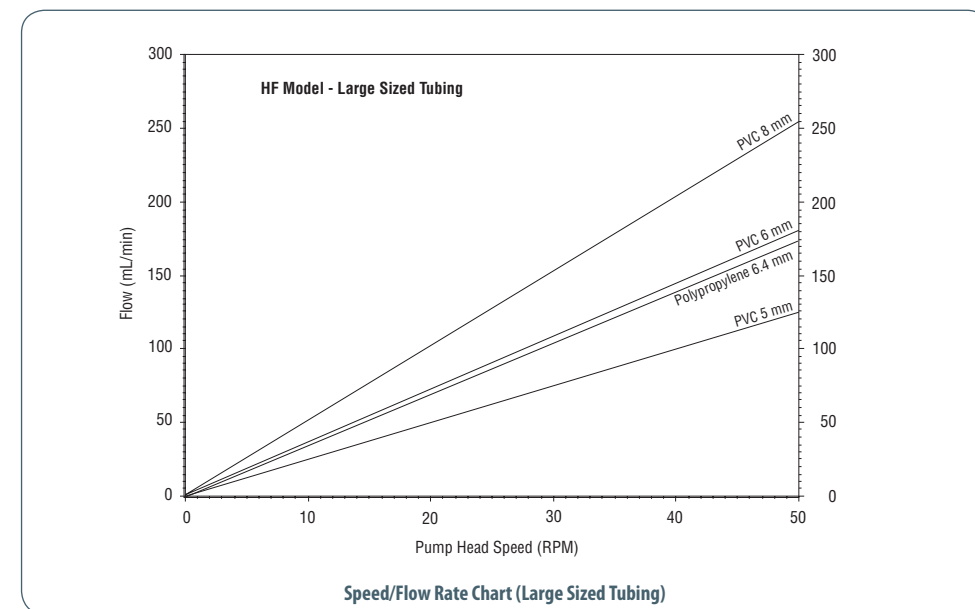

Speed/Flow Rate Chart (Large Sized Tubing)

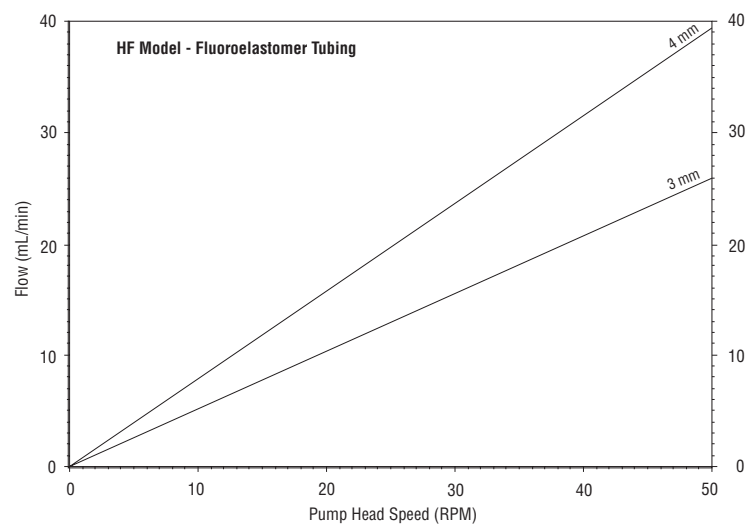

Speed/Flow Rate Chart (Fluoroelastomer Sized Tubing)

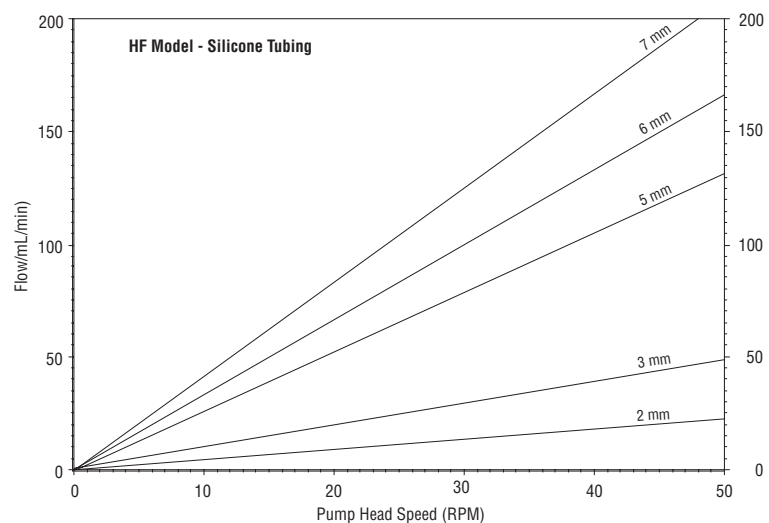

Speed/Flow Rate Chart (Silicone Sized Tubing)

Recommendations

- ▶ To ensure that consistent and accurate flow rates are maintained, systematically replace peristaltic tubing as soon as it appears to be worn. You can reduce wear on the tubing by running at slower speeds, by using tubing of a larger diameter, or by loosening the adjustment screws. Conversely, you should tighten the adjustment screws to reduce the level of pulsations, which may also be reduced by applying some back pressure, or by selecting a more rigid tubing material, like PVC.
- ▶ When the pump is not in use, release the compression cams by pressing on the bevelled corners of the trigger key and slacken the tubing. This increases the life of the tubing.
- ▶ A small piece of Iso-Versinic® tubing is supplied in the standard accessory package. Fit one piece to the pump head by pushing it onto the drain. The purpose of the drain is to remove liquid from the pump head if the flow tubing breaks; it limits the risk of liquid seeping into the speed control module, which contains the motor and electronic circuitry.
- ▶ To prevent liquid from leaking in the event of a tube breaking, install the pump at a higher level than the tank and collector. This arrangement eliminates gravitational flow.
- ▶ If the pump is used as part of a system where a back pressure is present (for example, against a chromatographic column), the adjustment screw must be tightened by one or two extra turns to enable the liquid to flow. Where back pressure is present, the maximum flow rates are less than the values that can be measured from the charts, which are plots of values measured at atmospheric pressure (refer to **Flow Rate Selection and Adjustment** beginning on page 16).
- ▶ Use the RABBIT key to prime the tubing (fill it with liquid); see **5 - OPERATION**, beginning on page 21.

Gilson Connectors and Couplers

Gilson can supply connectors for linking peristaltic tubing with connection tubing, and couplers for other equipment, such as low-pressure liquid chromatography columns. Refer to the **7 - APPENDIX**, beginning on page 33, for part numbers.

Connectors

Tubings are connected by simply pushing the tubings onto either end of a connector.

Plastic connectors are used for the larger diameter tubings. Three types are available:

F1179941, small bore (1 to 2 mm) to small bore,

F1179931, small bore (1 to 2 mm) to large bore (2 to 3 mm),

F1179951, large bore (2 to 3 mm) to large bore.

Metal sleeve connectors are used for very small bore tubing. Three sizes are available from Gilson for connecting tubing from 0.25 mm ID to 0.8 mm ID.

Tubing ID	0.25	0.3–0.5	0.6–0.8	1–2	2–3
0.25	Sleeve (0.6 OD)				
0.3–0.5	Sleeve (0.8 OD)				
0.6–0.8	Sleeve (1.1 OD)				
1–2			Plastic	Plastic	
2–3	Plastic				

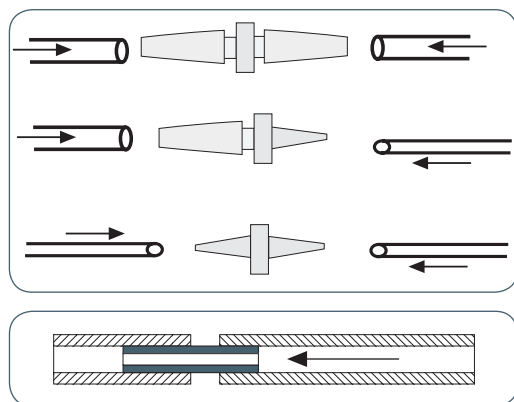

Coupling Kits

These are used to connect the peristaltic tubing to PTFE tubing having flanged ends, or to connect the peristaltic tubing to Low Pressure Liquid Chromatography (LPLC) systems. The coupling kit consists of a connection screw and a cone. The figure shows a typical connection to an LPLC system.

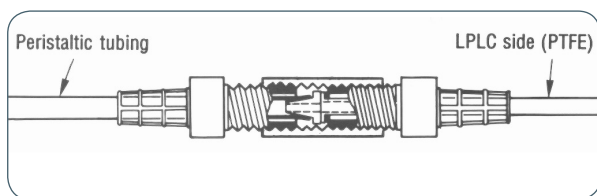

A Tefzel® connector (part number 495051) is available for connecting flexible tubing (ID 1 to 3 mm) to tubing connection screws at Gilson chromatography column outlets.

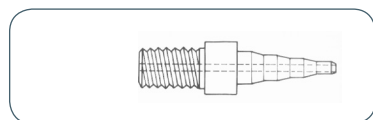

Couplers

Two types of couplers are available.

F1410050 consists of a set of five PVDF couplers for linking two standard Gilson connection screws (1/4"-28 TPI).

495036 consists of one Teflon® coupler for linking connection screws of different sizes (1/4"-28 TPI to 10 mm standard thread).

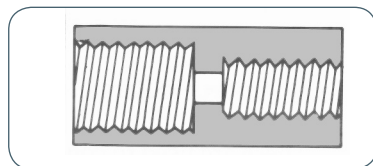
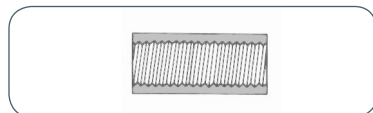

5 - OPERATION

Install the pump and make the required hydraulic and electrical connections. Refer to **4 - SETUP** beginning on page 11.

Switch the pump on using the rear-panel switch.

Then refer to the following sections, which describe how to use the keypad to control the pump, or to **6 - REMOTE CONTROL** beginning on page 26, if the pump is to be controlled remotely.

Keypad Functions

The keypad has six keys plus a 3-digit and 2-symbol Liquid Crystal Display unit. The keypad functions are summarized below.

- 1 Slower** Decrease the pump speed
- 2 Faster** Increase the pump speed
- 3 Rabbit** Set speed to 48 rpm for priming
- 4 Forwards** Start the pump clockwise
- 5 Backwards** Start the pump counter-clockwise
- 6 Stop** Stop the pump



Initialization



CAUTION The safety cover must be installed on the pump head before operating the pump. Failure to do so presents a mechanical hazard to the user.

- 1 Install tubing as described in **4 - SETUP** beginning on page 11.
- 2 Make sure that the MINIPULS 3 is connected to the external power supply and that the external power supply is connected to a power source, using the appropriate power cord for your line voltage.
- 3 Switch the pump ON using the rear panel switch. The speed is set at 12.5 rpm at delivery. The last speed set before switching off is shown in rpm on the keypad display.
- 4 Select the desired speed by pressing:
 - the (-) key to decrease the displayed value,
 - the (+) key to increase the displayed value.
 Pressing either key once changes the right-hand digit by one; pressing the key continuously makes the speed vary at an increasing rate.

- 5 To start the pump, press the  or the  key, depending on the desired direction of rotation. A (+) sign or a (-) sign is then displayed to the left of the speed value.

Press the **RABBIT** key to purge or to prime the tubing. The **RABBIT** key cannot be used until either the  or the  key has been pressed. The direction of pumping can be changed without stopping the pump.

Pressing the **RABBIT** key gives the maximum speed of 48 rpm in the previously selected direction.

When pressed, the display shows (+ - - -) or (- - - -), but the previous speed is stored in memory. If pressed a second time, the pump rotates at the preset speed; the same is applicable if either the  or the  key is pressed.

The **STOP** key stops the pump and stores the displayed speed for the next start up command. If the key is pressed when the pump is revolving at the RABBIT speed, the last speed selected before RABBIT selection is stored for the next start up command.



When the pump is remote-controlled, a ← symbol is displayed above the (+) or (-) sign.

Autostart Function

The Autostart Function enables the pump to restart pumping at power on, in a predetermined way. When the power is restored, the pump idles regardless of its status when the power was cut. The display flashes until any key is pressed.

The Autostart Function has three modes, as described in the next three paragraphs; mode selection is described in the following paragraph.

Non-autostart Mode

During mode selection, this mode is indicated by a dash "-" to the left of the identification number. In this mode, each time the speed is changed, the current speed is stored in non-volatile memory (provided no other key is pressed within three seconds of selecting the speed). Subsequently, when the pump is switched on, the previously selected speed is shown on the display. The pump operates at this speed when either the  or the  key is pressed.

Autostart Mode

During mode selection, this mode is indicated by a letter "A" to the left of the identification number. In this mode, the last speed and direction are stored in non-volatile memory (provided no other key is pressed within three seconds of selecting the speed or direction). Subsequently, when the pump is switched on, the pump operates in the way that it did before it was switched off.

Hold Mode

During mode selection, this mode is indicated by a letter "H" to the left of the identification number. In this mode, although speed and direction changes are effective at the time that they are made, the non-volatile memory is not updated. When the pump is switched on again, the pump operates in a way that is pre-determined by the user, regardless of any changes that were made before it was switched off.

To set the pre-determined values that are effective when the pump is switched on, proceed as follows.

- 1 Put the pump in the "Autostart" mode (see **Mode Selection**).
- 2 Set the speed and direction, wait for five seconds, and then switch off.
- 3 Switch on while pressing the **STOP** key, then select the "Hold" mode using the **RABBIT** key.
- 4 Press the **STOP** key to exit the configuration program.

The values set in this mode are preserved until the mode is changed to either Autostart or Non-autostart.

Mode Selection

To select the mode:

- 1 Turn the power off.
- 2 Press the **STOP** key, and while holding it, turn the power on again.
- 3 The display then shows one of three symbols to indicate the current mode ("A", "H", or "-") followed by a 2-digit identification number (see **Changing the Unit ID**).
- 4 Press the **RABBIT** key until the symbol indicating the required mode appears.
- 5 Press the **STOP** key to validate the selection.

Changing the Unit ID

The unit ID identifies each instrument to Gilson software packages that can issue GSIOC commands to the instrument. There is no need to change this number unless it is the same as that assigned to another Gilson instrument that's also connected along the GSIOC.

At the factory, Gilson set the unit ID for the MINIPULS 3 to 30.

To change the unit ID, turn the power OFF. Turn the power ON again while pressing the **STOP** key. The display shows "A30". Using the "+" and "-" keys, select the desired ID number. Then, press the **STOP** key to quit.



Maintenance and Troubleshooting

Routine maintenance

The only routine maintenance required is to clean up any spilled liquids and periodically to clean the outside of the MINIPULS 3 with a damp cloth.

Replace tubing when it shows signs of wear, such as flatness or cracking. Damaged tubing can cause excessive pulsations and erratic flow.

Troubleshooting

Problem	Solution
Blank Display	<p>If the display is blank when the pump is turned ON, proceed as follows:</p> <p>If the fan does not run. Check the power connection and (if necessary) replace the power supply. If the display remains blank, contact your local Gilson representative.</p> <p>If the fan runs. Check the electronics by pressing the  or  key. If the pump head does not rotate, there could be a problem with the electronics (faulty board). Contact the service agency.</p>
Dead Keypad	<p>If the "+" and the "-" keys have some effect, the pump is probably under remote control. If not, the keypad could need replacing. Contact the service agency.</p>
No GSIOC Response	<p>Check the GSIOC ID number, GSIOC cables, connectors, and GSIOC interface module. If these actions fail to correct the problem, there could be a problem with the electronics (faulty board). Contact your local Gilson representative.</p>
Worn or Faulty Pump Head	<p>Replace the pump head.</p>

Repair and Return Policies

Before Calling Us

Your local Gilson representative will be able to serve you more efficiently if you have the following information:

- serial number and model number of the instruments involved.
The serial number for the MINIPULS 3 is located on the rear panel near the fan.
- installation procedure you used
- list of concise symptoms
- list of operating procedures and conditions you were using when the problem arose
- list of all instruments in the configuration and the connections to those instruments
- list of other electrical connections in the room

Warranty Repair

Units covered under warranty will be repaired and returned to you at no charge. If you have any questions about applicability, contact your local Gilson representative.

Non-Warranty Repair

For out-of-warranty repairs, contact your local Gilson representative who will discuss service options with you and can assist in making arrangements to return the equipment, if necessary.

Return Procedure

Contact your local Gilson representative to obtain authorization before returning any Gilson equipment. To return a piece of equipment:

Carefully pack the unit to prevent damage in transit. Check with your local Gilson representative regarding proper method of shipment. No responsibility is assumed by Gilson or your local Gilson representative for damage caused by improperly packaged instruments. Indicate the authorization on the carton and on the packing slip.

Always insure for the replacement value of the unit.

Include a description of symptoms, your name, address, phone number, and purchase order to cover repair costs, return and shipping charges, if your institution requires it.

Unit End-of-Life

When a unit reaches the end of its useful life, refer to www.gilson.com for directions and information on the end-of-life policy. This is in accordance with the European Union Directive 2002/96/EC on

Waste Electrical and Electronic Equipment (WEEE).



6 - REMOTE CONTROL

Remote contact control is not available if the MINIPULS 3 is already under GSIOC or keypad control. To transition from keypad control to remote control, the pump must be in an idle state.

Electrical Contact Control

There are two contact inputs and one analog input available on the 8-pin terminal block connector. These TTL low-level active inputs (0–5V) have a threshold of 2 Volts and are pulled up to 5 Volts with a high impedance. The connection diagram is shown at right.

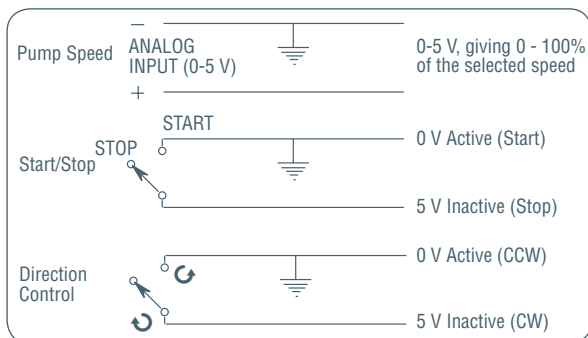

Start/Stop Input (Contact Input)

The pump can be started by closing the start/stop input, and stopped by opening it. The input is closed by shorting pin 3 to ground (pin 2, 4, or 8). Closing this input starts the pump in the direction selected by the Direction Control input at the speed defined by the Analog Input. When the pump is started using this input, the keypad has no effect until the Start/Stop contact is opened again.

Direction Control (Contact Input)

When the Direction Control contact is opened, the pump rotates in the forward direction (clockwise). When this contact is closed, the pump rotates in the reverse direction (counter-clockwise). The direction of rotation may be changed while the pump is running, in which case the transition is immediate.

Pump Speed (Analog Input)

A DC voltage (0–5V) or a resistance (resistor or potentiometer) between pin 7 and ground can be used to change the rotation speed as described below.

Voltage control: $\text{Effective Speed} = (\text{Selected Speed} \times \text{Applied Voltage}) / 5 \text{ Volts}$

The Applied Voltage is expressed in Volts.

The Selected Speed is displayed before the Start/Stop input is activated.

The Effective Speed is displayed after the Start/Stop input is activated.

Resistance control: $\text{Effective Speed} = (\text{Reference Speed} \times \text{Resistance}) / (\text{Resistance} + 68)$

The resistance is expressed in kOhms.

The Reference Speed is obtained with an infinite resistance (open circuit).

Control by Gilson Devices

Please refer to the respective technical manuals. For more details, please contact your local Gilson representative.

GSIOC Control

Gilson systems feature a two-way communication interface between the computer and most Gilson instruments. Communication occurs along the Gilson Serial Input Output Channel (GSIOC).

Each instrument is identified by a unique unit ID, designated by a number between 0 and 63.

The default unit ID of the MINIPULS 3 is 30.

Using the computer and software, you:

- specify the instrument you want to control
- issue commands that set operating parameters, control operation, or request information from that instrument

GSIOC Commands

There are two kinds of commands that you can send over the GSIOC:

- **Buffered commands** send instructions to the instrument. These commands are executed one at a time.
- **Immediate commands** request status information from the instrument. These commands are executed immediately, temporarily interrupting other commands in progress.

For more information on GSIOC, refer to the GSIOC Technical Manual (part number LT2181).

Control Modes

The MINIPULS 3 offers two levels of digital control mode: **Keypad** and **Remote**.

- ▶ The **Keypad mode** is the default. The MINIPULS 3 normally works through the keypad and responds to immediate commands through GSIOC. It is similar to the local mode of some computer-controlled devices.
- ▶ In the **Remote mode**, the keypad is locked and the unit receives commands and key-codes from the GSIOC. Contact inputs are disabled.

Command Descriptions

Below is the list of available commands in alphabetical order. This list may be used as a quick reference guide.

A detailed description of each command is provided.

The default response given in some of the following descriptions is the response returned by the MINIPULS 3 when an immediate command is sent at power on, or after a master reset. The response to a buffered command is a period (.).

Because the controller command buffer is 40 characters long, buffered command strings can be as long as 39 characters, the last character being the CR (Carriage Return) ASCII code.

Command	Type	Mode	Function
%	I	Keypad and Remote	Request Module Identification
?	I	Keypad and remote	Request Mode Status
\$	I	Keypad and remote	Master Reset
I	I	Keypad and remote	Request Contact Input Status
K	B	Remote	Input Remote Keystroke
K	I	Keypad and remote	Request Keypad Status
R	B	Remote	Set Speed
R	I	Keypad and remote	Read Display
S	B	Keypad and remote	Set External Mode
V	I	Keypad and remote	Request Analog Input Status

Command	%
Type	Immediate
Mode	Keypad and Remote
Function	Module identification
Response format	"312Va.b.c.d" where a.b.c.d identifies the software version
Command	?
Type	Immediate
Mode	Keypad and Remote
Function	Request Mode Status
Response format	"K" for keypad, "R" for remote
Default response	"K"
Command	\$
Type	Immediate
Mode	Keypad and Remote
Function	Master reset
Response format	\$ is echoed

Command	I
Type	Immediate
Mode	Keypad and Remote
Function	Request Contact Input Status
Response format	"ab" where "a" reflects pin 3 (START/STOP input) "b" reflects pin 1 (CW/CCW input) "a" and "b" take values of either 0 or 1 "1" is an inactive or high input (open) "0" is an active or low input (closed)
Default response	"11"
Command	K
Type	Buffered
Mode	Remote
Function	Input remote keystrokes. Mimic key actions.
Syntax	K codes
Parameters	String of characters as follows: "<" = backwards (CCW) ">" = forwards (CW) "+" = faster "-" = slower "H" = stop "&" = rabbit
Comments	All other characters are ignored. A buffered "K" command must be the last in a command string.
Note: To make this command work properly, the MINIPULS 3 should not be disconnected from the system master until the buffer is empty. To ensure that this is true the master should send another command (such as an empty string) immediately after any string containing a "K" command. Completion of the first string is implied as soon as the second is accepted	

Command	K
Type	Immediate
Mode	Keypad and Remote
Function	Request keypad status
Response format	<p>"cs" where</p> <p>"c" is the code of the last key pressed. "<" = backwards (CCW) ">" = forwards (CW) "+" = faster "-" = slower "H" = stop "&" = rabbit "s" is the key's status "!" if the key was pressed after the last request "-" if the key remains pressed after the last request " " a space means that no key was pressed</p>
Default response	"\$"

Command	R
Type	Buffered
Mode	Remote
Function	Set speed
Syntax	Rrrrr
Parameter	rrrr is the new speed in hundredths of a revolution per minute (ranging between 0 and 4800)
Comment	An input of "R" is interpreted as "R0"

Command	R
Type	Immediate
Mode	Keypad and Remote
Function	Read Display
Response format	<p>"dXX.XXca" where</p> <p>"d" is the direction status " " a space if stopped "+" if CW "-" if CCW "XX.XX" is the speed status in rpm "—.—" at full speed (rabbit) "c" is the control status "K" if started through the keypad "R" if started through the contacts or set to remote mode through GSIOC "a" is the autostart condition "*" if in autostart condition (display flashing) " " a space if not in autostart</p>
Default response	"12.50K" when the pump is new

Command	S
Type	Buffered
Mode	Keypad and Remote
Function	Set External Control Mode. Switches between modes.
Syntax	Sm
Parameter	"m" = "K" for keypad or "R" for remote mode

Command	V
Type	Immediate
Mode	Keypad and Remote
Function	Request Analog Input Status
Response format	"vvv" where "vvv" is a three-character code (range 000 - 255)
Default response	"255" (255 corresponds to 5V, or open circuit)

Examples

Example 1:

To set the speed at 25 rpm.

Command	Comment
(I) \$; Master Reset
(B) SR	; Set remote mode
(B) R2500	; Set speed to 25.00 rpm

This sets the speed without starting the pump; it does not rotate.

Example 2:

To mimic the key entry sequence CCW+FULL SPEED.

Command	Comment
(I) \$; Master Reset
(B) SR	; Set remote mode
(B) K<	; Select CCW direction
(B) K&	; Full speed (rabbit)

7 - APPENDIX

This chapter contains part numbers and technical data (specifications).

Part Numbers

Six pump heads are available: four standard models (1, 2, 4, or 8 channels) and two HF models (2 or 4 channels). Pump heads are ordered separately. A speed control module is also required and is supplied with an accessory package. Refer to the tables for part numbers.

Pump Head						
Model	R1	R2	R4	R8	R2/HF	R4/HF
	F117604	F117800	F117606	F117608	F117830	F117831

Speed Control Module						
Model	MP1	MP2	MP4	MP8	MP2/HF	MP4/HF
Channels	1	2	4	8	2	4
	F155001					

Standard Accessory Package

Refer to the table for a listing of the items included in the standard accessory package.

Item	Qty	Part Number
Peristaltic tubing pack - 1 x PVC tubing (i.d. 0.4 mm) for MP models - 1 x PVC tubing (i.d. 3.2 mm) for MP and HF models - 1 x silicone tubing (i.d. 7 mm) for HF models <i>(Each tubing is just over 0.4 m long and is fitted with retaining stops)</i>	1	F117930
Drain tubing (Isoversinic, 200 mm x 10 mm x 7 mm)	1	F155081
Pump head screw	2	4011564204
Power cord for 220-240 V for external power supply	1	7080316106
Power cord for 100-120 V for external power supply	1	7080318107
24V external power supply	1	549512025
Terminal block connector (8-pin)	1	6383087203
User's Guide	1	LT801121

Additional Accessories

Additional accessories such as tubing and connectors can be supplied by Gilson. These items are described in 4 - SETUP beginning on page 11, and are listed below.

Connectors

Metal Sleeve Connectors for Small Bore Tubing

Part No.	Description
F117985	Set of 5 Stainless steel connectors 0.6 mm OD
F117986	Set of 5 Stainless steel connectors 0.8 mm OD
F117987	Set of 5 Stainless steel connectors 1.1 mm OD

Plastic Connectors for Large Bore Tubing

Part No.	Description
F1179931	Set of 10, PVDF connectors for 1-2 mm id tubing to 2-3 mm
F1179941	Set of 10, PVDF connectors for 1-2 mm id tubing to 1-2 mm
F1179951	Set of 10, PVDF connectors for 2-3 mm id tubing to 2-3 mm

Connector Kits for Flanged Tubing

Part No.	Description
F1825054	Set of 5 (screw & cone) for 1.0-1.65 mm id tubing (3 mm max. OD)
F1825056	Set of 5 (screw & cone) for 2.0-2.3 mm id tubing (4 mm max. OD)

Couplers

Part No.	Description
495036	One PTFE coupler to connect high pressure tube-end fittings between 1/4"-28 TPI and 10 mm standard thread.
F1410050	Set of 5 PVDF couplers for linking two standard Gilson connection screws (1/4"-28 TPI).

Polyvinylchloride (PVC) Tubing

For use with medium concentration aqueous solutions (acidic or basic).

Polyvinylchloride (PVC) Calibrated Peristaltic tubing

0.4 meter lengths of PVC peristaltic tubing (with stops)

Part No.	Description
F117932	Set of 12 PVC Flow tubes of 0.25 mm id
F117933	Set of 12 PVC Flow tubes of 0.38 mm id
F117934	Set of 12 PVC Flow tubes of 0.51 mm id
F117936	Set of 12 PVC Flow tubes of 0.76 mm id
F117938	Set of 12 PVC Flow tubes of 1.02 mm id
F117940	Set of 12 PVC Flow tubes of 1.30 mm id
F117942	Set of 12 PVC Flow tubes of 1.52 mm id
F117943	Set of 12 PVC Flow tubes of 1.65 mm id
F117945	Set of 12 PVC Flow tubes of 2.06 mm id
F117946	Set of 12 PVC Flow tubes of 2.29 mm id
F117948	Set of 12 PVC Flow tubes of 2.79 mm id
F117949	Set of 12 PVC Flow tubes of 3.16 mm id

Polyvinylchloride (PVC) Connection Tubing

Part No.	Description
F117952	3 meters tubing 0.25 mm id
F117953	3 meters tubing 0.38 mm id
F117954	3 meters tubing 0.51 mm id
F117956	3 meters tubing 0.76 mm id
F117958	3 meters tubing 1.02 mm id
F117960	3 meters tubing 1.30 mm id
F117962	3 meters tubing 1.52 mm id
F117963	3 meters tubing 1.65 mm id
F117965	3 meters tubing 2.06 mm id
F117966	3 meters tubing 2.29 mm id
F117968	3 meters tubing 2.79 mm id
F117969	3 meters tubing 3.16 mm id

Polyvinylchloride (PVC) Connection Tubing (HF)

For use with high flow pump heads only.

Part No.	Description
F117970	3 meters PVC tubing 4 mm id
F117980	3 meters PVC tubing 5 mm id
F117981	3 meters PVC tubing 6 mm id
F117982	3 meters PVC tubing 8 mm id

Fluoroelastomer Tubing (Iso-Versinic®/Viton®)

For use with strong acids, oils, aromatic and chlorinated solvents.

Iso-Versinic Calibrated Peristaltic tubing

0.40 meter lengths of Iso-Versinic peristaltic tubing (with stops).

Iso-Versinic Connection Tubing

Part No.	Description
F1817741	Set of 4 Isoversinic flow tubes 0.5 mm id
F1817743	Set of 4 Isoversinic flow tubes 1.0 mm id
F1817745	Set of 4 Isoversinic flow tubes 2.0 mm id
F117747	Set of 4 Isoversinic flow tubes 3.0 mm id
F117749	Set of 4 Isoversinic flow tubes 4.0 mm id

Part No.	Description
F117740	3 meters Isoversinic tubing 0.5 mm id
F117742	3 meters Isoversinic tubing 1.0 mm id
F117744	3 meters Isoversinic tubing 2.0 mm id
F117746	3 meters Isoversinic tubing 3.0 mm id
F117748	3 meters Isoversinic tubing 4.0 mm id
F117750	3 meters Isoversinic tubing 6.0 mm id

Silicone Tubing

Silicone Calibrated Peristaltic tubing

0.40 meter lengths of Silicone peristaltic tubing (with stops).

Silicone Connection Tubing

Reference	Description
F1825111	Set of 4 Silicone flow tubes 0.6 mm id
F1825112	Set of 4 Silicone flow tubes 1.0 mm id
F1825113	Set of 4 Silicone flow tubes 2.0 mm id
F1825114	Set of 4 Silicone flow tubes 2.8 mm id

Part No.	Description
F1825131	3 meters Silicone tubing 0.6 mm id
F1825132	3 meters Silicone tubing 1 mm id
F1825133	3 meters Silicone tubing 2 mm id
F117975	3 meters Silicone tubing 3 mm id
F117976	3 meters Silicone tubing 4 mm id
F117977	3 meters Silicone tubing 5 mm id
F117978	3 meters Silicone tubing 6 mm id
F117979	3 meters Silicone tubing 7 mm id

Polypropylene (PharMed®) Tubing

For use in the pharmaceutical and food industries.

Polypropylene Calibrated Peristaltic Tubing

0.4 meter lengths of peristaltic tubing (with stops).

Polypropylene Connection Tubing

Part No.	Description
F1825101	Set of 4 Polypropylene Flow tubes of 0.5 mm id
F1825102	Set of 4 Polypropylene Flow tubes of 1.0 mm id
F1825103	Set of 4 Polypropylene Flow tubes of 2.0 mm id

Part No.	Description
F1825121	3 meters Polypropylene tubing 0.5 mm
F1825122	3 meters Polypropylene tubing 1.0 mm
F1825123	3 meters Polypropylene tubing 2.0 mm
F1825124	3 meters Polypropylene tubing 3.2 mm
F1825125	3 meters Polypropylene tubing 6.4 mm

Electrical Connector

Part No.	Description
6383087203	CONN, TERM BLK 8PIN 2.5MM

Technical Specifications

Operating Temperature: 4–40°C

No warm-up time is required before operation

Position: Upright only (vertical ±5°).

Head Speed: 0.01 to 48 rpm

Torque: Greater than 3 Nm at any speed below 25 rpm, at or above the nominal voltage (24V DC)

Motor Speed Stability: 0.5% for any variation, torque, or temperature

Continuous Speed Adjustment: From 0 to 48 rpm by 0.01 increments up to 9.99 rpm, above 9.99 rpm by 0.1 increments

Flow Rate Range:

Maximum: MP model 40 mL/min (1.8 L/h, 4 mm tubing), HF model 250 mL/min (15 L/h, 8 mm tubing)

Minimum: 0.3 µL/min (0.25 mm tubing)

Maximum Back Pressure: 0.5 MPa (72.5 psi) for MP models, 0.3 MPa (43.5 psi) for HF models

Peristaltic Tubing Diameter: 0.25 to 4 mm (ID) for MP models, 2 to 8 mm (ID) for HF models

Power Requirements: *External Power Supply*

Voltage Input 100–240V AC, 50 to 60 Hz

Voltage Output 24V DC, 1.7A, 41W

Dimensions without pump heads (W x D x H): 15.0 x 17.5 x 18.5 cm (5.9 x 6.9 x 7.3 in.)

Humidity: Up to 80%

Weight: 2.5 kg (5.5 lbs.)

Altitude: Up to 2000 m

Gilson, Inc.

PO Box 620027 | Middleton, WI 53562-0027, USA

Tel: 800-445-7661 or 608-836-1551 | Fax: 608-831-4451

Gilson S.A.S.

19, avenue des Entrepreneurs | BP 145, F-95400 Villiers-le-Bel, France

www.gilson.com

sales@gilson.com | service@gilson.com | training@gilson.com

LT801121-16 ©2013 Gilson, Inc. | All rights reserved.

