

Register your instrument!
www.eppendorf.com/myeppendorf



Mastercycler[®] nexus

Operating manual

Copyright© 2018 Eppendorf AG, Germany.

All rights reserved, including graphics and images. No part of this publication may be reproduced without the prior permission of the copyright owner.

Eppendorf® and the Eppendorf Brand Design are registered trademarks of Eppendorf AG, Germany.

Mastercycler®, flexlid®, SteadySlope® and Eppendorf twin.tec® are registered trademarks of Eppendorf AG, Germany.

Registered trademarks and protected trademarks are not marked in all cases with ® or ™ in this manual.

U.S. Patents are listed on www.eppendorf.com/ip.

Notice

The software of the Mastercycler nexus contains open source software. License information is available as PDF documents via the Eppendorf node. To export the license documents, connect a memory device, select the Eppendorf node in the navigation tree and press the softkey License.

Table of contents

1	Operating instructions	7
1.1	Using this manual	7
1.2	Danger symbols and danger levels	7
1.2.1	Danger symbols	7
1.2.2	Danger levels	7
1.3	Symbols used	8
1.4	Abbreviations used	9
1.5	Glossary	10
2	Safety	11
2.1	Intended use	11
2.2	User profile	11
2.3	Information on product liability	11
2.4	Warnings for intended use	12
2.5	Danger symbols on the device	14
3	Product description	15
3.1	Product overview	15
3.1.1	Master variants	15
3.1.2	Master variants with thermoblock (64+32 wells)	16
3.1.3	Master variant with flat thermoblock	17
3.1.4	Eco variants	18
3.1.5	Terminal block	19
3.1.6	Control panel	20
3.1.7	Number pad	21
3.1.8	Status lamp	21
3.2	Delivery package	21
3.3	Features	22
3.3.1	Features of the Mastercycler nexus	23
3.3.2	Control panel and ports	24
3.3.3	Consumable	25
3.3.4	Networking	26
3.3.5	Service	26
4	Installation	27
4.1	Selecting the location	27
4.2	Installing the device	28
4.2.1	Connecting the device to the power supply	28
4.2.2	Attaching devices to each other	29
4.2.3	Separating devices	30
4.2.4	Using the USB ports	30
4.2.5	Connecting the eco device	31
4.3	Shut down	32

5	Operation	33
5.1	Initial steps	33
5.1.1	Using the flexlid heated lid	33
5.2	Starting the Mastercycler nexus	35
5.2.1	Defining the administrator PIN	35
5.2.2	Other steps	36
5.3	Logging in and out as a user	37
5.3.1	Logging in as a user	37
5.3.2	Changing users	38
5.3.3	Logging out as a user	38
5.4	Overview of software operation	39
5.4.1	Navigation tree overview	39
5.4.2	Navigating in the navigation tree	40
5.4.3	Using external storage media	40
5.4.4	Selecting export file formats	41
5.5	Managing folders and programs	41
5.5.1	Creating folders and programs	42
5.5.2	Copying folders and programs	44
5.5.3	Deleting folders and programs	44
5.6	Using the schedule	44
5.6.1	Editing a schedule entry	45
5.6.2	Displaying the schedule	46
5.7	Using the power save mode	46
6	Programming	49
6.1	Overview of the program editor	49
6.1.1	Opening the program editor	49
6.1.2	Structure of the program editor	50
6.2	Making general settings	51
6.2.1	Opening the header	51
6.2.2	Editing header settings	52
6.3	Editing programs	53
6.3.1	Inserting a program step	53
6.3.2	Editing parameters	54
6.3.3	Create gradient step	55
6.3.4	Deleting program steps	57
6.3.5	Exporting a program as a PDF or text file	57
6.3.6	Saving a program and exiting the editor	58
6.4	Program templates	59

7	PCR run	61
7.1	Loading the thermoblock	61
7.1.1	Selecting the sample tubes	61
7.1.2	Inserting the sample tubes	62
7.2	Starting a program	63
7.2.1	Status view	64
7.2.2	Common status view for devices with a thermoblock with 64+32 wells	65
7.3	Interrupting or stopping a program	66
7.3.1	Interrupting a program	66
7.3.2	Resuming a program	66
7.3.3	Stopping a program	66
7.4	Displaying the most recently run programs	66
8	System management	69
8.1	Administrator functions	69
8.2	Managing user accounts	69
8.2.1	Creating a user account	69
8.2.2	Editing a user account	70
8.2.3	Deleting a user account	70
8.2.4	Changing the administrator PIN	71
8.3	System settings	72
8.4	Cycler functions	75
8.4.1	Cycler system functions	76
8.4.2	Self-test	77
8.5	Managing and backing up data	78
8.5.1	Backing up data	78
8.5.2	Exporting and importing programs	79
8.6	Transferring programs from an older Mastercycler model	79
8.7	Network connection	81
8.7.1	Setting up a network connection	82
8.7.2	Setting up e-mail notifications	83
8.7.3	Setting up syslog messages	84
8.7.4	Activating remote access	86
9	Quick start	87
9.1	Login	87
9.2	Creating folders and programs	88
9.3	Copying folders and programs	88
9.4	Deleting folders and programs	89
9.5	Editing programs	89
9.6	Stopping and starting programs	91
10	Maintenance	93
10.1	Cleaning	93
10.1.1	Cleaning the housing	93
10.1.2	Cleaning the heated lid and the thermoblock	94
10.2	Disinfection/decontamination	94
10.3	Decontamination before shipment	94

11 Troubleshooting	95
11.1 General errors	95
12 Transport, storage and disposal	97
12.1 Packing	97
12.2 Disposal	98
13 Technical data	99
13.1 Power supply	99
13.2 Weight/dimensions	99
13.3 Ambient conditions	99
13.4 Application parameters	100
14 Ordering information	105
14.1 Mastercycler nexus	105
14.1.1 Master variants	105
14.1.2 Eco variants	106
14.2 Accessories	106
14.3 Consumables	107
14.4 Recommended auxiliary materials	108
Index	109
Certificates	113

1 Operating instructions

1.1 Using this manual









- ▶ Read this operating manual completely before using the device for the first time.
- ▶ Consider this manual as part of the product and keep it somewhere easily accessible.
- ▶ If this operating manual is lost, please request another one. The current version of the operating manual can be found on our webpage www.eppendorf.com.

 The sequences of actions in this operating manual are described for operation using the control panel. You can also operate the Mastercycler nexus using the mouse (see p. 30).

1.2 Danger symbols and danger levels

1.2.1 Danger symbols

The safety instructions in this manual have the following danger symbols and danger levels:

	Biohazard		Explosive substances
	Electric shock		Hot surfaces
	Risk of crushing		Toxic substances
	Hazard point		Material damage

1.2.2 Danger levels

DANGER	<i>Will</i> lead to severe injuries or death.
WARNING	<i>May</i> lead to severe injuries or death.
CAUTION	May lead to light to moderate injuries.
NOTICE	May lead to material damage.

1.3 Symbols used

Depiction	Meaning
1. 2.	Actions in the specified order
▶	Actions without a specified order
•	List
<i>Text</i>	Display or software texts
i	Additional information

1.4 Abbreviations used

DHCP

Dynamic Host Configuration Protocol (network)

DNS

Domain Name System (network)

IP

Internet Protocol (network)

MAC

Media Access Control (network)

PCL

Printer Command Language – standard for printer control

PCR

Polymerase Chain Reaction

PDF

Portable document format

PIN

Personal Identification Number

PS

PostScript (standard for printer control)

SMTP

Simple Mail Transfer Protocol (network)

TSP

Thermal Sample Protection

USB

Universal Serial Bus

1.5 Glossary

F

flexlid

The heated lid of the thermal cycler automatically adapts to the used tubes or plates. This always ensures that a reliable pressure is applied to the thermoblock and that the tubes are sealed securely. Unlike conventional heated lids, they do not need to be manually adjusted.

T

Thermal Sample Protection

When the heated lid is being heated, the thermoblock is actively maintained at a constant temperature. This minimizes non-specific annealing and evaporation of the samples.

Triple circuit technology

The thermoblock is controlled by three independent control loops. This is necessary to produce temperature gradients and leads to improved temperature homogeneity.

2 Safety

2.1 Intended use

The Mastercycler nexus is used for temperature control of aqueous solutions, suspensions or emulsions in closed micro test tubes for enzymatic reactions, typically the polymerase chain reaction (PCR).

The Mastercycler nexus is exclusively intended for indoor use.

All country-specific safety requirements for operating electrical equipment in laboratories must be observed.

The product can be used for training, routine and research laboratories in the areas of life sciences, industry or chemistry. This product is intended to be used for research purposes only. Eppendorf does not provide a warranty for other applications. The product is not suitable for use in diagnostic or therapeutic applications. The product may only be used by skilled personnel who have been trained in the areas mentioned above.

2.2 User profile

The device and accessories may only be operated by trained and skilled personnel.

Before using the device, read the operating manual carefully and familiarize yourself with the device's mode of operation.

2.3 Information on product liability

In the following cases, the designated protection of the device may be affected. Liability for any resulting damage or personal injury is then transferred to the owner:

- The device is not used in accordance with the operating manual.
- The device is used outside of its intended use.
- The device is used with accessories or consumables that are not recommended by Eppendorf.
- The device is maintained or repaired by persons not authorized by Eppendorf AG.
- The user makes unauthorized changes to the device.

2.4 Warnings for intended use

Read the operating manual and observe the following general safety instructions before using the Mastercycler nexus.



DANGER! Risk of explosion.

- ▶ Do not operate the device in areas where work is completed with explosive substances.
- ▶ Do not use this device to process any explosive or highly reactive substances.
- ▶ Do not use this device to process any substances which could create an explosive atmosphere.



WARNING! Risk of fire.

- ▶ Do not use this device to process any highly flammable liquids.



WARNING! Damage to health due to infectious liquids and pathogenic germs.

- ▶ When handling infectious liquids and pathogenic germs, observe the national regulations, the biological security level of your laboratory, the Material Safety Data Sheets, and the manufacturer's application notes.
- ▶ Wear your personal protective equipment.
- ▶ For comprehensive regulations about handling germs or biological material of risk group II or higher, please refer to the "Laboratory Biosafety Manual" (source: World Health Organization, Laboratory Biosafety Manual, in its respectively current valid version).



WARNING! Lethal voltages inside the device.

Touching parts which are under high voltage may cause an electric shock. An electric shock injures the heart and causes respiratory paralysis.

- ▶ Ensure that the housing is closed and undamaged.
- ▶ Do not remove the housing.
- ▶ Ensure that no liquid can penetrate into the device.

Only authorized service staff may open the device.



WARNING! Biohazard when tempering with the heated lid open.

When tempering with an open heated lid, the lids of the reaction vessels can spring open. This will release sample material.

- ▶ Only temper with a closed heated lid.



WARNING! Biohazard due to unsuitable reaction vessels, plates and lids.

Unsuitable reaction vessels, plates and lids will get damaged in the Cyclor. This will release sample material.

- ▶ Only use reaction vessels, plates and lids that meet the requirements specified in the operating manual.



CAUTION! Risk of burns on the thermoblock, heated lid and reaction vessels.

The thermoblock, heated lid and reaction vessels reach temperatures of over 50 °C very quickly.

- ▶ Wait until the temperature of the thermoblock, heated lid and reaction vessels is below 30 °C.
- ▶ Then open the heated lid.



CAUTION! Poor safety due to incorrect accessories and spare parts.

The use of accessories and spare parts other than those recommended by Eppendorf may impair the safety, functioning and precision of the device. Eppendorf cannot be held liable or accept any liability for damage resulting from the use of incorrect or non-recommended accessories and spare parts, or from the improper use of such equipment.

- ▶ Only use accessories and original spare parts recommended by Eppendorf.



WARNING! Risk of injury when lifting the device.

If the device is moved using the lid, the lid may break, causing the device to fall.

- ▶ Lift the device by holding it at the bottom of the housing.
- ▶ Use both hands to carry the device.
- ▶ Do not lift the device using the lid.



CAUTION! Risk of injury when lifting and carrying heavy loads.

The device is heavy. Lifting and carrying the device can lead to back injuries.

- ▶ Only lift and transport the device with a sufficient number of helpers.
- ▶ Use a transport aid for transporting the device.



NOTICE! Damage to electronic components due to condensation.

Condensate can form in the device after it has been moved from a cool environment to a warmer environment.

- ▶ After installing the device, wait for at least 12 h. Only then connect the device to the mains/power line.

2.5 Danger symbols on the device

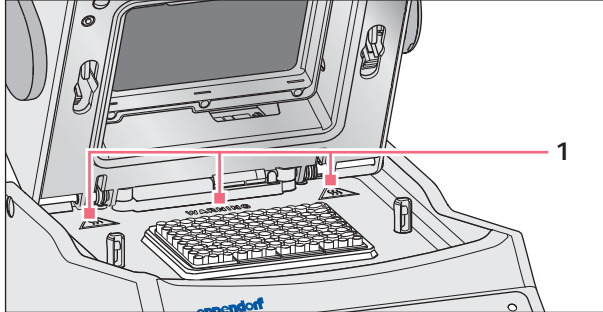

Fig. 2-1: Warning symbols on the Mastercycler



Burns due to hot surfaces.

If the heated lid is open, you may suffer burns when touching the thermoblock and the hot plate.

- ▶ Do not touch any hot surfaces.

3 Product description

3.1 Product overview

3.1.1 Master variants

- Mastercycler nexus
- Mastercycler nexus gradient
- Mastercycler nexus SX1
- Mastercycler nexus GSX1

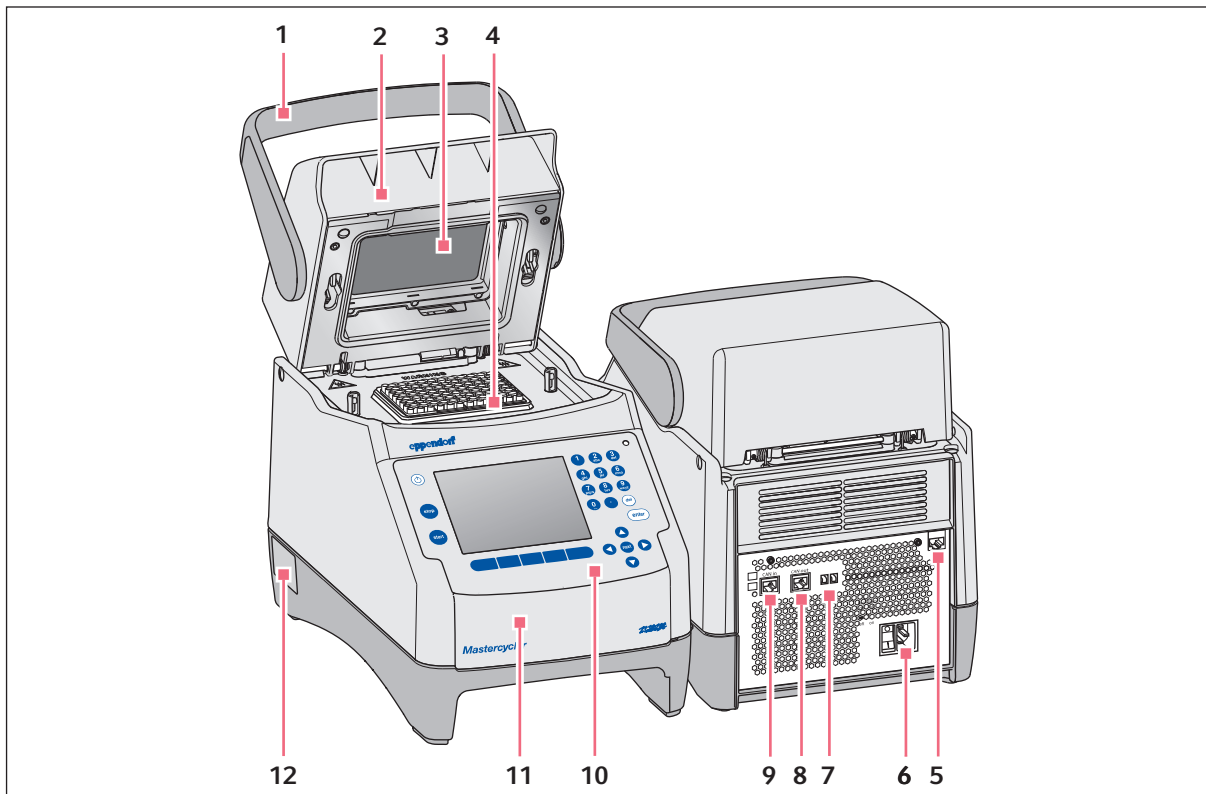

Fig. 3-1: Front and rear view

- | | |
|--|---|
| 1 Lid handle
For opening, closing, locking and unlocking the heated lid. | 7 Eco and Term switches |
| 2 Heated lid | 8 CAN out port |
| 3 Heating plate | 9 CAN in port |
| 4 Thermoblock | 10 Control panel
See detailed drawing (see p. 20) |
| 5 Ethernet port | 11 Flap
USB port cover. |
| 6 Mains connection socket with power switch
0 = switched off, I = switched on. | 12 Name plate |

3.1.2 Master variants with thermoblock (64+32 wells)

- Mastercycler nexus X2
- Mastercycler nexus GX2

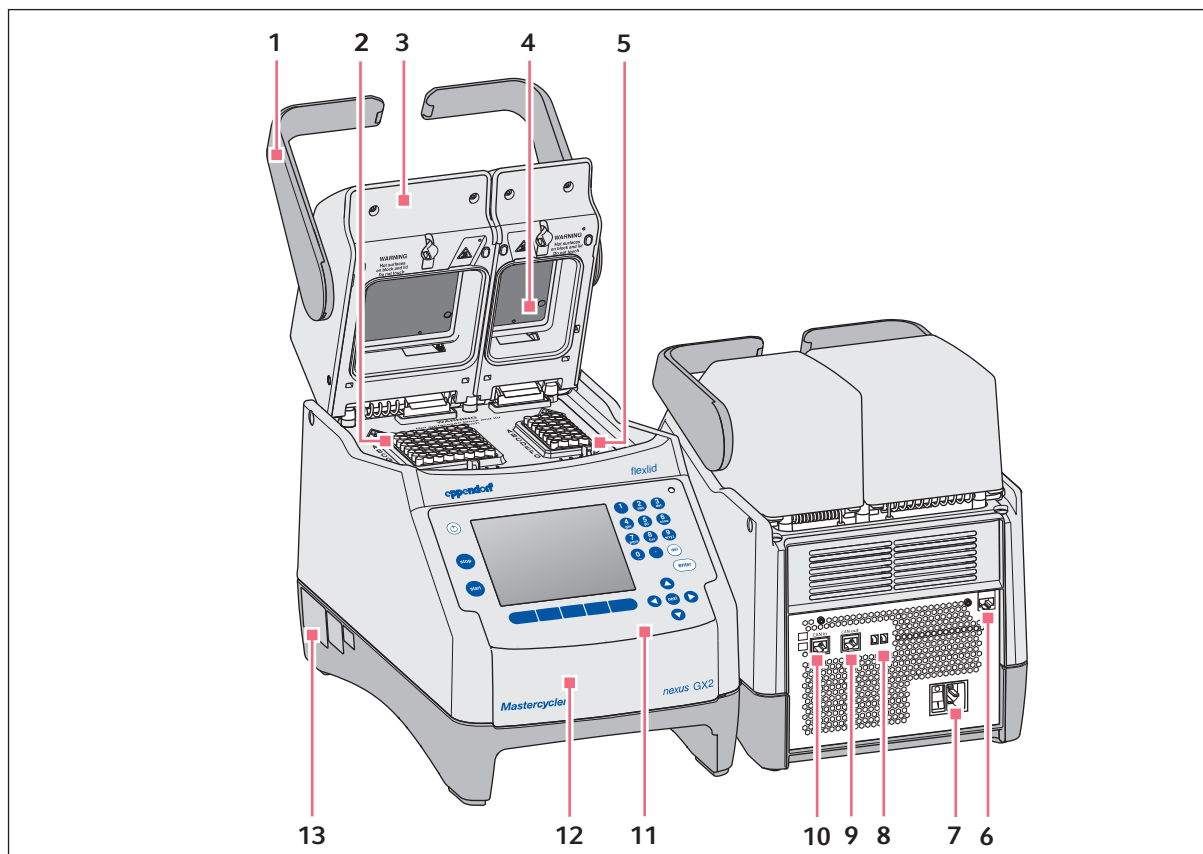

Fig. 3-2: Front and rear view

- | | |
|--|---|
| <p>1 Lid handle
For opening, closing, locking and unlocking the heated lid.</p> <p>2 Thermoblock with 64 wells</p> <p>3 Heated lid</p> <p>4 Heating plate</p> <p>5 Thermoblock with 32 wells</p> <p>6 Ethernet port</p> <p>7 Mains connection socket with power switch
0 = switched off, I = switched on.</p> | <p>8 Eco and Term switches</p> <p>9 CAN out port</p> <p>10 CAN in port</p> <p>11 Control panel
See detailed drawing (see p. 20)</p> <p>12 Flap
USB port cover.</p> <p>13 Name plate</p> |
|--|---|

3.1.3 Master variant with flat thermoblock

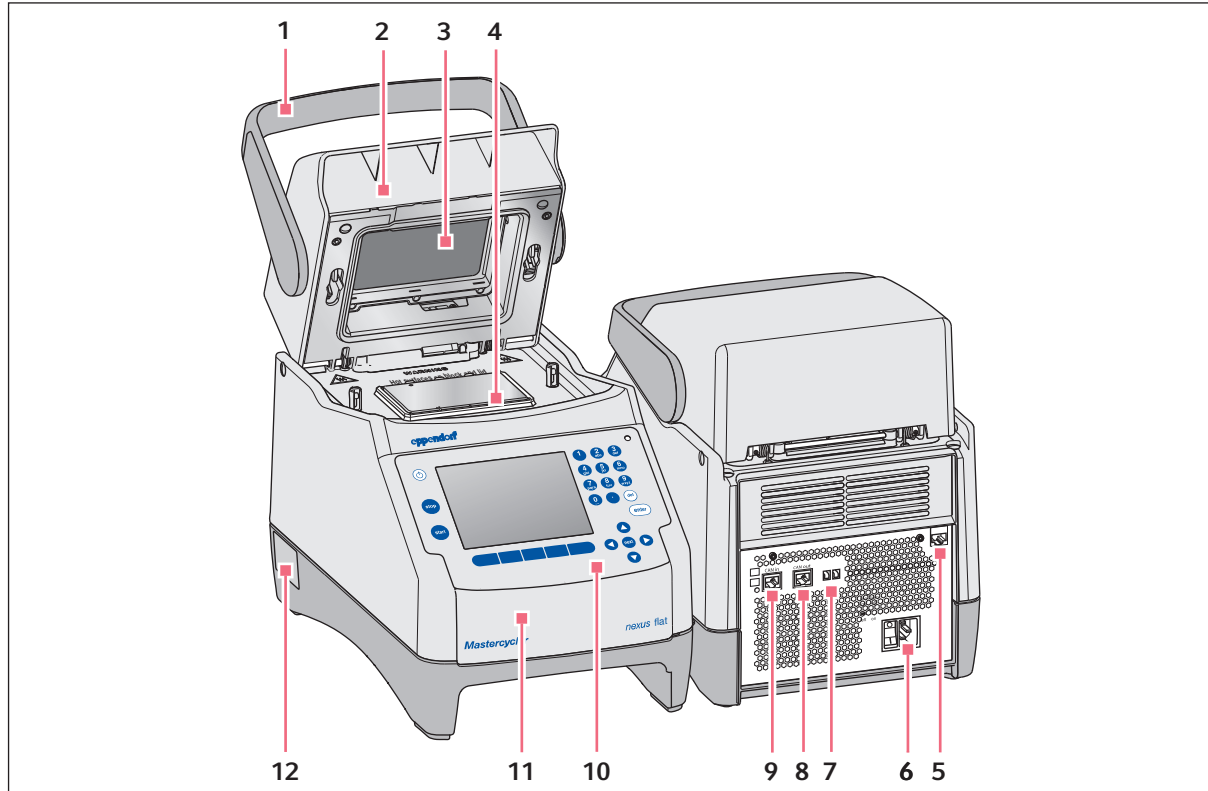

Fig. 3-3: Front and rear view of the Mastercycler nexus flat

- | | |
|--|--|
| <p>1 Lid handle
 For opening, closing, locking and unlocking the heated lid.</p> <p>2 Heated lid</p> <p>3 Heating plate</p> <p>4 Thermoblock</p> <p>5 Ethernet port</p> <p>6 Mains connection socket with power switch
 0 = switched off, I = switched on.</p> | <p>7 Eco and Term switches</p> <p>8 CAN out port</p> <p>9 CAN in port</p> <p>10 Control panel
 See detailed drawing (see p. 20)</p> <p>11 Flap
 USB port cover.</p> <p>12 Name plate</p> |
|--|--|

3.1.4 Eco variants

- Mastercycler nexus eco
- Mastercycler nexus gradient eco
- Mastercycler nexus SX1e
- Mastercycler nexus GSX1e
- Mastercycler nexus X2e (with a thermoblock with 64+32 wells; not shown in the figure)
- Mastercycler nexus GX2e (with a thermoblock with 64+32 wells; not shown in the figure)
- Mastercycler nexus flat eco (with a flat thermoblock; not shown in the figure)

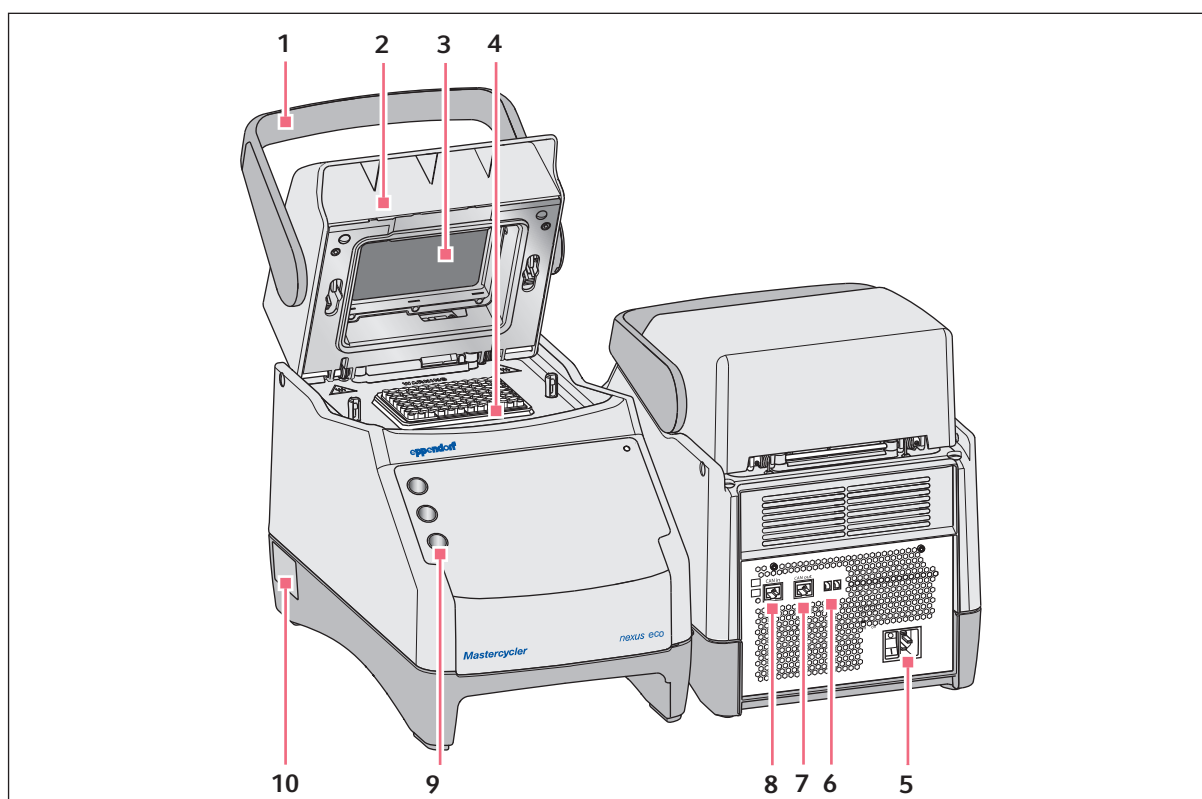

Fig. 3-4: Front and rear view

1 Lid handle

For opening, closing, locking and unlocking the heated lid.

2 Heated lid

3 Heating plate

4 Thermoblock

5 Mains connection socket with power switch

0 = switched off, I = switched on.

6 Eco and Term switches

7 CAN out port

8 CAN in port

9 Pen holder

Holds up to three pens.

10 Name plate

3.1.5 Terminal block

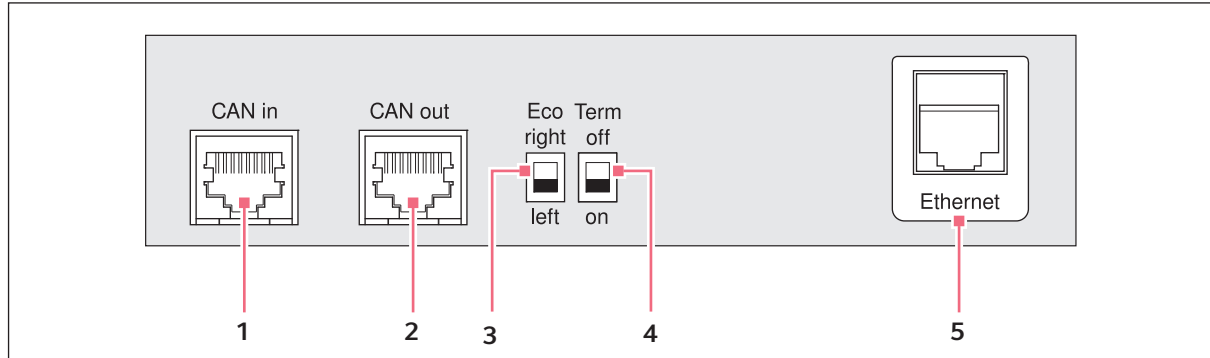

Fig. 3-5: Terminal block

- | | |
|--|---|
| <p>1 CAN in port
Connection to an eco device.</p> | <p>4 Term switch
Termination of the CAN data connection if connected to the eco device.</p> |
| <p>2 CAN out port
Connection to a second eco device.</p> | <p>5 Ethernet port (not in the case of an eco device)
Connection of a master variant of the Mastercycler nexus to an Ethernet network.</p> |
| <p>3 Eco switch
Adjusts the position of eco device (left or right next to a master variant with control panel).</p> | |

Only connect devices to the interfaces of the Mastercycler nexus that comply with the IEC 950/EN 60950 (UL 1950) standards.

3.1.6 Control panel

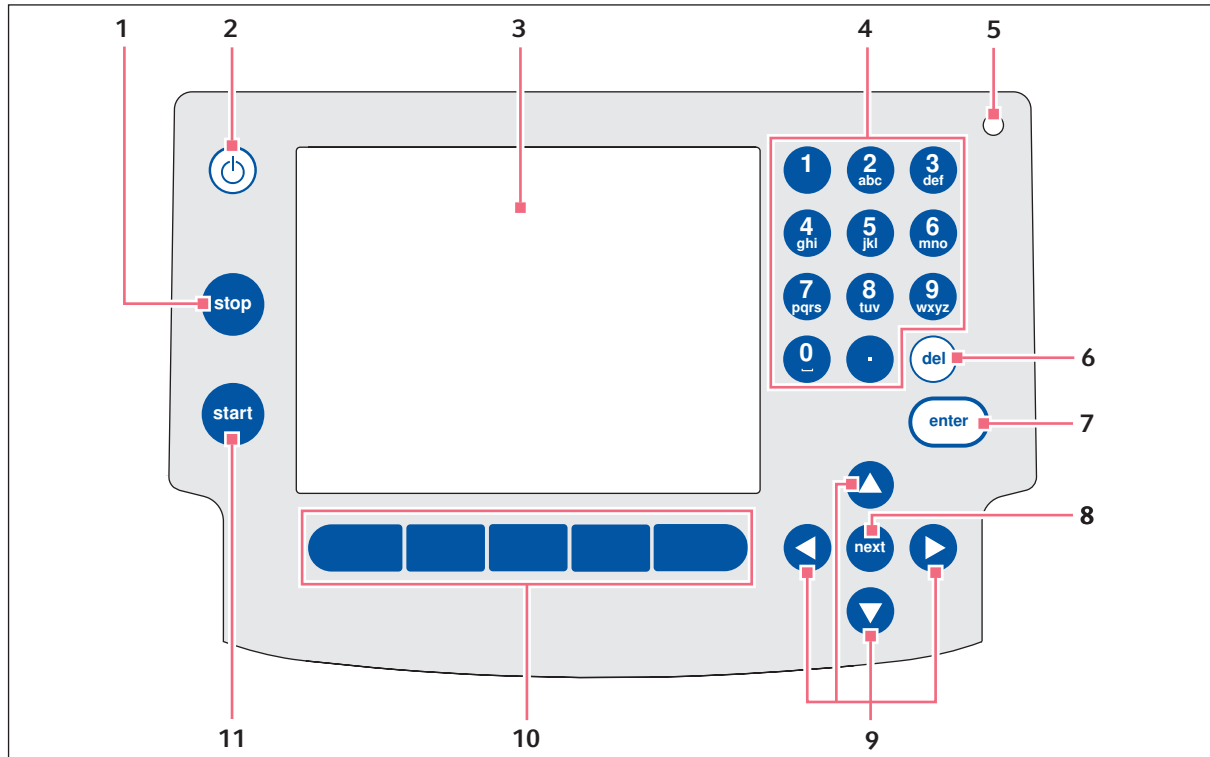

Fig. 3-6: Control panel

- | | |
|--|--|
| <p>1 stop key
Stop the running program.</p> <p>2 Standby key
To switch the device to power save mode.</p> <p>3 Display</p> <p>4 Number pad</p> <p>5 Status lamp
In the case of devices with a thermoblock with 64+32 wells, the status lamp in the control panel is deactivated. The active status lamp for devices with a thermoblock with 64+32 wells is located on the heated lid.</p> <p>6 del key
To delete marked objects and characters to the right of the cursor.</p> | <p>7 enter key
To confirm entries and open selection lists.</p> <p>8 next key
Move the cursor to the next input field.</p> <p>9 Arrow keys
Move the cursor.</p> <p>10 Softkeys
Function depends on the software dialog and is indicated in the display above the softkey.</p> <p>11 start key
Start the selected program.</p> |
|--|--|

3.1.7 Number pad



Enter digits and text in input fields. For numeric input fields (e.g. temperature, time), the keys only have numbers. For decimal numbers with numbers after the decimal point, use the period as a decimal point. Alphanumeric input fields have keys with multiple functions.

- ▶ To enter text, press the key with the desired letter until the respective letter is displayed.

Example: To enter *pcr 3* in a text field, press the following keys one after the other:

1. For *p*: press **7** once.
2. For *c*: press **2** three times.
3. For *r*: press **7** three times.
4. For the space: press **0** (zero) twice.
5. For *3*: press **3** four times.

3.1.8 Status lamp

Status lamp	Operating status
Briefly flashes green	The device is in standby mode. The display is switched off.
Lights up green	The device is in idle mode.
Flashes green	A program run is active.
Flashes orange	The program run is waiting for a user action in the Pause or Hold step.
Flashes red	A fault has occurred. Additional information on the fault appears on the display.

3.2 Delivery package

Quantity	Description
1	Mastercycler nexus as ordered
1	Operating manual for all Master versions. Eco devices are delivered without an operating manual.
1	Certificate of Conformity
1	Mains/power cord
1	CAN bus cable (only with eco devices)

Product description

Mastercycler® nexus
English (EN)

3.3 Features

Triple Circuit Technology

The Triple Circuit Technology leads to a homogeneous temperature distribution and enables for Mastercycler nexus gradient, Mastercycler nexus GSX1 and Mastercycler nexus GX2 a selective generation of temperature gradients for PCR optimizations.

SteadySlope

The SteadySlope technology ensures that the heating and cooling rates of the thermoblock in gradient operation are identical to those in normal operation. A reliable transfer of the optimization results to the routine application is ensured.

flexlid

All variants of the Mastercycler nexus have a flexlid heated lid. It enables ergonomic operation with one hand and automatically adjusts the contact pressure for all tubes and PCR plates.

Thermal Sample Protection

The Thermal Sample Protection technology maintains a constant thermoblock temperature of 20°C during the warm-up phase of the heated lid. Thermal Sample Protection reduces the thermal load on your samples and minimizes the probability of non-specific product formation during the PCR.

Self-test function

The master variants of the Mastercycler nexus have an integrated self-test function. The self-test function provides a simple way of testing the correct function of the thermoblock without any further tools. A separately available USB key is required for the self test function (see *Accessories on p. 106*).

Control

The eco variants of the Mastercycler nexus do not have a control panel. They are controlled via a connected master variant of the Mastercycler nexus.

Standby function

All variants of the Mastercycler nexus can be switched to standby mode automatically or by pressing a key. This reduces energy consumption and ensures that the device is ready for use at any time.

3.3.1 Features of the Mastercycler nexus

	Thermoblock version	Thermoblock material	Freely programmable temperature gradient (gradient spread)
Mastercycler nexus gradient	96-well format	Aluminum	X (max. 20°C)
Mastercycler nexus gradient eco	96-well format	Aluminum	X (max. 20°C)
Mastercycler nexus	96-well format	Aluminum	
Mastercycler nexus eco	96-well format	Aluminum	
Mastercycler nexus GSX1	96-well format	Silver	X (max. 20°C)
Mastercycler nexus GSX1e	96-well format	Silver	X (max. 20°C)
Mastercycler nexus SX1	96-well format	Silver	
Mastercycler nexus SX1e	96-well format	Silver	
Mastercycler nexus flat	flat	Aluminum	X (max. 20°C)
Mastercycler nexus flat eco	flat	Aluminum	X (max. 20°C)
Mastercycler nexus GX2	64-well format and 32-well format	Aluminum	X (max. 12°C)
Mastercycler nexus GX2e	64-well format and 32-well format	Aluminum	X (max. 12°C)
Mastercycler nexus X2	64-well format and 32-well format	Aluminum	
Mastercycler nexus X2e	64-well format and 32-well format	Aluminum	

3.3.2 Control panel and ports

	Control panel	Ethernet port	USB port
Mastercycler nexus gradient	X	X	2
Mastercycler nexus gradient eco	—	—	—
Mastercycler nexus	X	X	2
Mastercycler nexus eco	—	—	—
Mastercycler nexus GSX1	X	X	2
Mastercycler nexus GSX1e	—	—	—
Mastercycler nexus SX1	X	X	2
Mastercycler nexus SX1e	—	—	—
Mastercycler nexus flat	X	X	2
Mastercycler nexus flat eco	—	—	—
Mastercycler nexus GX2	X	X	2
Mastercycler nexus GX2e	—	—	—
Mastercycler nexus X2	X	X	2
Mastercycler nexus X2e	—	—	—

3.3.3 Consumable

	PCR tubes (0.1 mL or 0.2 mL)	PCR tubes *) (0.5 mL)	PCR plates	PCR slide (in situ)
Mastercycler nexus gradient	96	71	1x 96-well	—
Mastercycler nexus gradient eco	96	71	1x 96-well	—
Mastercycler nexus	96	71	1x 96-well	—
Mastercycler nexus eco	96	71	1x 96-well	—
Mastercycler nexus GSX1	96	—	1x 96-well	—
Mastercycler nexus GSX1e	96	—	1x 96-well	—
Mastercycler nexus SX1	96	—	1x 96-well	—
Mastercycler nexus SX1e	96	—	1x 96-well	—
Mastercycler nexus flat	—	—	—	4
Mastercycler nexus flat eco	—	—	—	4
Mastercycler nexus GX2	64 + 32	45 + 19	2x 32-well 1x 32-well or segments of separable 96-well PCR plates	—
Mastercycler nexus GX2e	64 + 32	45 + 19	2x 32-well 1x 32-well or segments of separable 96-well PCR plates	—
Mastercycler nexus X2	64 + 32	45 + 19	2x 32-well 1x 32-well or segments of separable 96-well PCR plates	—
Mastercycler nexus X2e	64 + 32	45 + 19	2x 32-well 1x 32-well or segments of separable 96-well PCR plates	—

*) In the case of 0.5 mL tubes with a bigger lid, the number of usable sample places can be lower.

3.3.4 Networking

You can connect and control up to any two eco devices to a master variant of the Mastercycler nexus.

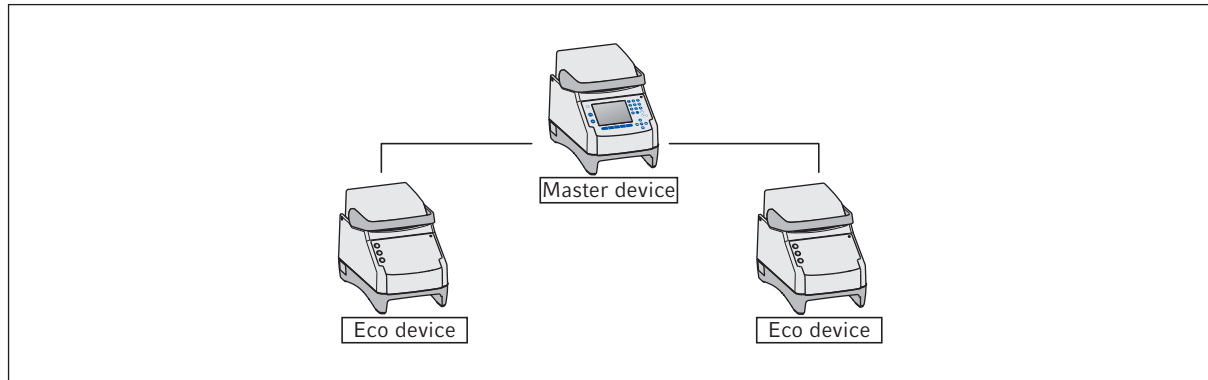

3.3.5 Service

Eppendorf offers customized service options for preventive maintenance and verification of your thermocycler. For more information, service requests and local offers go to www.eppendorf.com/epservices and see local websites.

4 Installation

4.1 Selecting the location



WARNING! Risk of injury due to unsuitable work surface.

The device may fall over if placed on an unsuitable work surface.

- ▶ Observe the criteria in the operating manual on selecting a location.
-



NOTICE! Damage from overheating.

- ▶ Do not place the device near heat sources (e.g., heating, drying cabinet).
 - ▶ Do not expose the device to direct sunlight.
 - ▶ Ensure unobstructed air circulation. Maintain a clearance of at least 30 cm around all ventilation slits.
-



When the device is in operation, ensure that the device mains/power switch and the cutting unit of the power system circuit (e.g., residual current circuit breaker) are accessible.

Information regarding the dimensions and weight of device components can be found in a separate section (see *Weight/dimensions on p. 99*).

Take the following criteria into account when selecting the location for the device:

- The surface must have sufficient bearing capacity and ensure the required stability.
- The surface must be free of vibration.
- The device feet must not slip.
- The height of the location should allow for convenient and safe operation of the device.

4.2 Installing the device

This section describes how to put the device into operation and how to connect one or two eco devices to a master variant of the Mastercycler nexus.

4.2.1 Connecting the device to the power supply



WARNING! Risk from incorrect supply voltage.

- ▶ Only connect the device to voltage sources which correspond to the electrical requirements on the name plate.
 - ▶ Only use sockets with a protective earth (PE) conductor and suitable mains/power cord.
-



NOTICE! Sample loss through interruption in the mains/power supply.

If you use multiple sockets, the current consumption of several devices may exceed the power current strength. The mains/power fuse interrupts the mains/power supply. The devices do not receive any power. The current programs are aborted.

- ▶ Connect the mains/power cord of each device directly to an earth/grounded socket.
 - ▶ Do not use multiple sockets.
-

Information on the power consumption of the Mastercycler nexus is provided separately (see *Power supply on p. 99*).

- ▶ Connect the mains connection socket to the power socket using a power cable.

4.2.2 Attaching devices to each other

You can attach adjacent devices to each other to prevent individual devices from slipping and avoid mechanical stress on the cables.

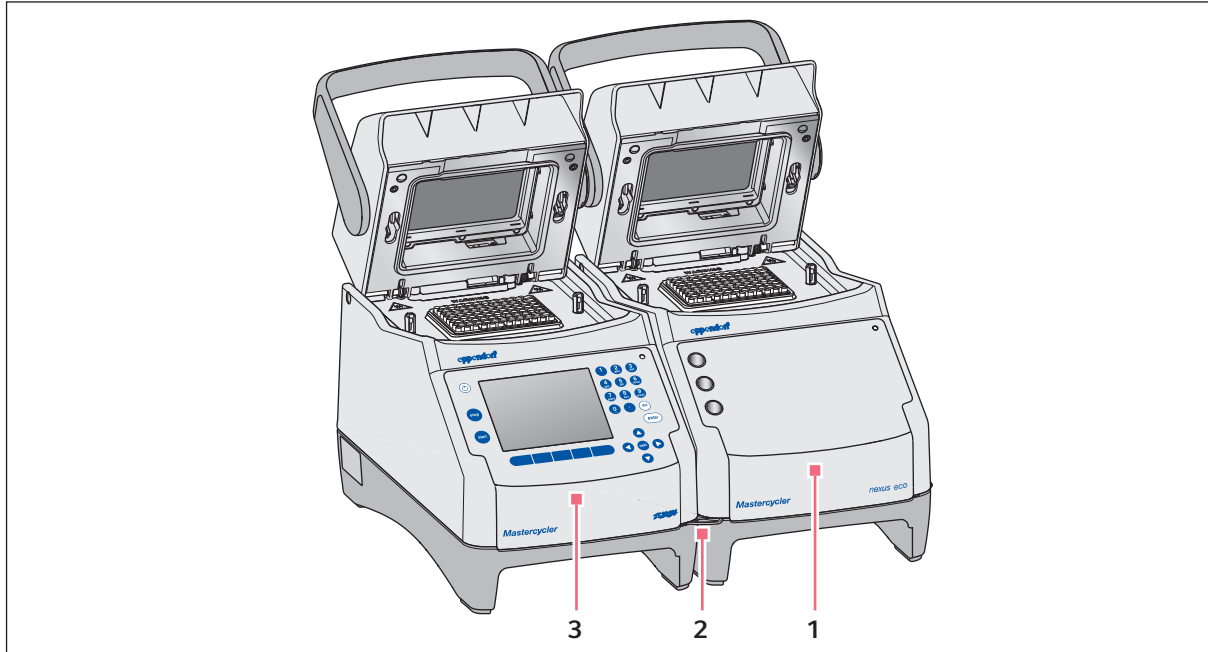

Fig. 4-1: Example: two Mastercycler nexus attached to each other

1 Eco variant Mastercycler nexus

3 Master variant Mastercycler nexus

2 Bracket



CAUTION! Danger from devices falling down.

The bracket can break or be released from the recess in the housing if you move or lift devices that are attached to each other. Devices could fall down and cause injury.

- ▶ Do not lift devices that are attached to each other with the bracket.
- ▶ Do not move devices that are attached to each other with the bracket.
- ▶ Separate the devices before lifting or moving them.

1. Position the devices next to each other.

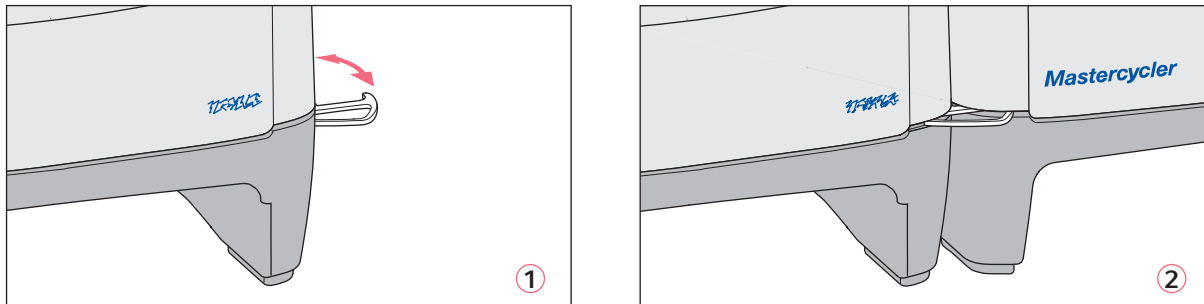

2. Fold out the bracket of the device on the left ①. Insert the bracket into the recess in the housing of the device on the right ②.
3. Align the devices attached to each other in parallel.

4.2.3 Separating devices

1. Switch off the devices at the power switch. Disconnect the cable connections at the rear of the devices.
2. Hold the bracket and push the device on the right back until the bracket comes out of the recess in the housing.
3. Fold the bracket away.

4.2.4 Using the USB ports

The master variants of the Mastercycler nexus have two USB ports for the connection of a mouse, printer, storage medium or the self-test USB key.



- Use a USB hub if you would like to connect more than two USB devices at the same time.
- The USB printer must be compatible with the **PostScript®** or **PCL** printer standards. Further information can be found in the operating manual for your printer.
- The eco devices do not have any USB ports.

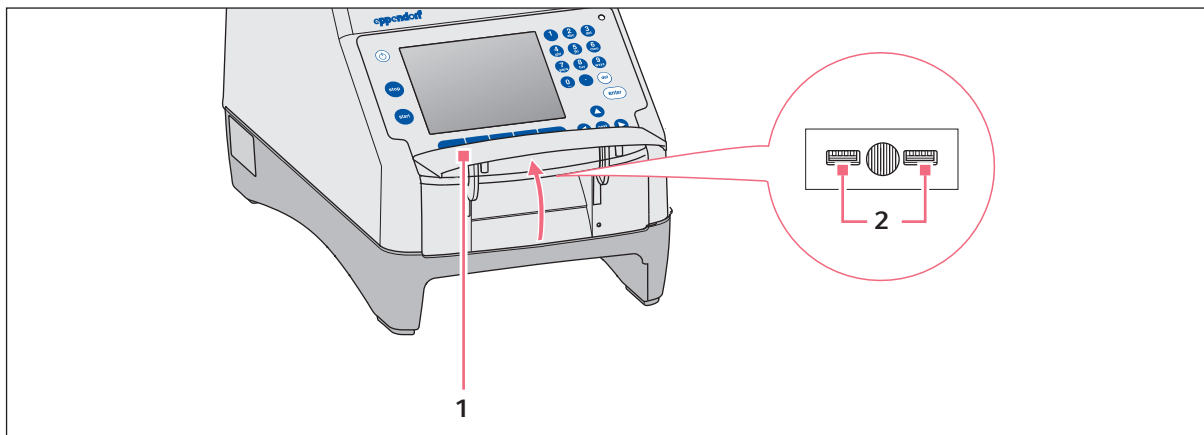

1. Open the flap (1) to access the USB ports (2).
2. Insert the USB device into one of the two ports.
 Newly connected USB devices are automatically detected during operation.
3. Close the flap.

4.2.5 Connecting the eco device

This section explains how to operate one or two eco devices together with a master variant of the Mastercycler nexus. The eco device is controlled via a master variant Mastercycler nexus. This requires a cable connection between the devices. Use Eppendorf CAN-bus cables for this (see *Accessories on p. 106*).

Connecting a single eco device

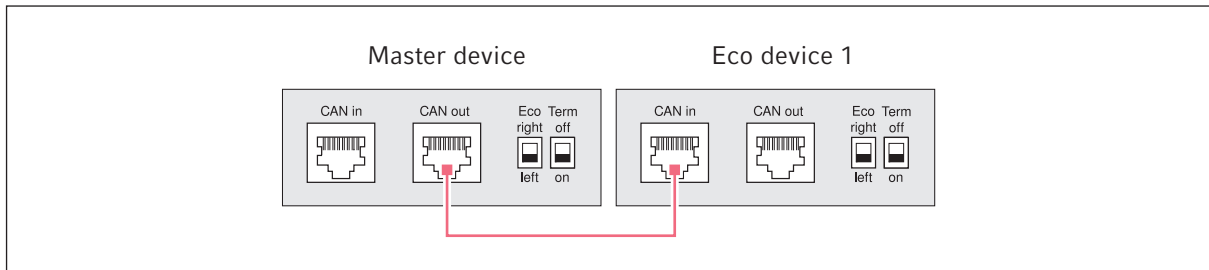

Fig. 4-2: Wiring diagram showing rear view of the devices

Connecting two eco devices

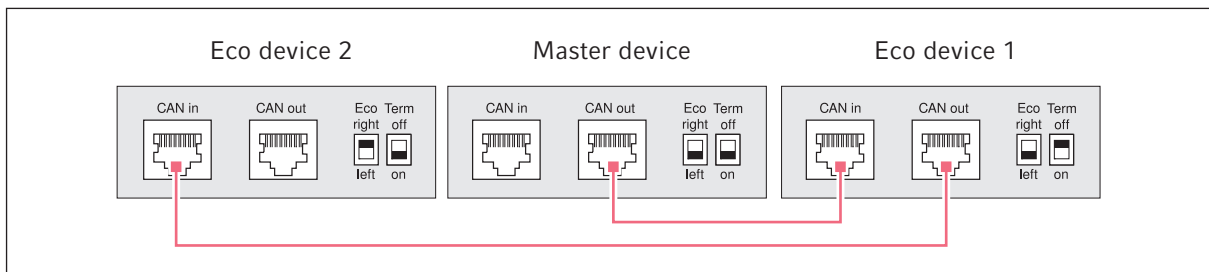

Fig. 4-3: Wiring diagram showing rear view of the devices

The connections and switches are located on the rear of the devices.

4.2.5.1 Establishing the data connection

1. Switch off all devices at the power switch.

Connecting the first eco device

2. Connect the CAN bus cable to the **CAN out** port of the Mastercycler nexus (with control panel) and to the **CAN in** port of the eco device.











Connecting the second eco device

3. Connect the second CAN bus cable to the **CAN out** port of the first eco device and to the **CAN in** port of the second eco device.

4.2.5.2 Setting the Eco and Term switches

You must set the **Eco** and **Term** switches on all devices depending on whether you have connected one or two eco devices to a master variant of the Mastercycler nexus.

- Set the **Eco** and **Term** switches on the rear of all connected devices as follows:

Connected devices	Master device		Eco device 1		Eco device 2	
One eco device	Eco right  left	Term off  on	Eco right  left	Term off  on	—	—
Two eco devices	Eco right  left	Term off  on	Eco right  left	Term off  on	Eco right  left	Term off  on



- The position of the **Eco** switch of the eco device should reflect its installation position on the left or right next to a master variant of the Mastercycler nexus with control panel.
- If you operate the Mastercycler nexus on its own, the position of the **Eco** and **Term** switches is not important.

4.3 Shut down

Proceed as follows if you do not want to use the Mastercycler nexus for longer than a week.

1. Load the block with an empty PCR plate or tube.
2. Close the heated lid and flip the handle forwards .
3. Disconnect the Mastercycler nexus from the power supply.

Never leave the lid of the Mastercycler nexus open to prevent contamination of the block.

5 Operation

5.1 Initial steps

Checking the correct installation

Before the Mastercycler nexus is commissioned for the first time, ensure that the following requirements are met:

- The device is correctly connected.
- The device is free of damage.
- Free circulation of air around the ventilation slots at the rear of the device and at the fan behind the front feet has been guaranteed.

5.1.1 Using the flexlid heated lid

The Mastercycler nexus is equipped with a flexlid heated lid. The flexlid heated lid automatically adjusts to the height of the used PCR tubes or PCR plates. It can be operated with one hand. Manual adjustment to the tube height, or adjusting the contact pressure to the tube lids, is not required.

The heated lid ensures uniform contact between the tubes and the thermoblock, and secures the tube lids against leaks. The heating process prevents condensation from forming in the upper area of the tube during the tempering of the reaction liquid.

5.1.1.1 Open heated lid



WARNING! Biohazard when tempering with the heated lid open.

When tempering with an open heated lid, the lids of the reaction vessels can spring open. This will release sample material.

- ▶ Only temper with a closed heated lid.



CAUTION! Risk of burns on the thermoblock, heated lid and reaction vessels.

The thermoblock, heated lid and reaction vessels reach temperatures of over 50 °C very quickly.

- ▶ Wait until the temperature of the thermoblock, heated lid and reaction vessels is below 30 °C.
 - ▶ Then open the heated lid.
-

Open the heated lid in one go as follows:

- ▶ Flip the lid handle up over the heated lid and flip the heated lid up at the lid handle as far as it will go.

5.1.1.2 Closing the heated lid

Prerequisites

Thermoblock loaded with sample tubes or a PCR plate.



CAUTION! Risk of crushing when closing the heated lid.

- ▶ Hold the middle of the handle on the heated lid.
- ▶ When you close the heated lid, do not place your fingers between the heated lid and the housing.



Comply with the guidelines for loading the thermoblock with PCR tubes (see *Loading the thermoblock on p. 61*).

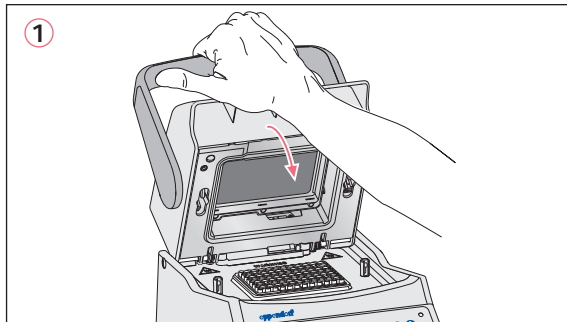

1. Grip the heated lid at the center of the lid handle and close it **(1)**.
2. Continue to move the lid handle further down until it is in a horizontal position **(2)**.



The force required to move the lid handle into the horizontal position depends on the type of PCR tubes or PCR plate used.

The heated lid is now locked. You can now start a program run or manually temper the heated lid and samples.

5.2 Starting the Mastercycler nexus

Prerequisites

The Mastercycler nexus is properly set up and connected to the power supply.

- ▶ Switch on the device using the power switch at the back (see p. 15).
The status lamp lights up and the fan starts.
The display illumination is switched on (not for Mastercycler nexus eco).

5.2.1 Defining the administrator PIN

The first time the device is started, you can define an administrator PIN to protect it against unauthorized access. The administrator PIN is saved and will be maintained even when the Mastercycler nexus is switched off.

If an administrator PIN has not been defined, you will be prompted to define one.



NOTICE! Data loss due to unauthorized use of the administrator password.

The administrator password protects the device software from unwanted access.

- ▶ Make a note of the administrator password.
- ▶ Keep the administrator password at a secure location.
- ▶ Only provide the administrator password to individuals who work with the system configuration.
- ▶ Please contact Eppendorf AG if you have any problems with the administrator password.



- If you do not want to use user management, you do not need to define an administrator PIN. In this case, leave the input fields in the *Input Admin PIN* window blank and deactivate the *PIN* function. Further information on user management can be found separately (see *System settings on p. 72*).
- If the *PIN* function is activated (see *System settings on p. 72*), you must define an administrator PIN. If you do not do this, the input prompt will appear each time the device is switched on.
- You can also change the administrator PIN at a later time (see *Changing the administrator PIN on p. 71*).

To define the administrator PIN, perform the following steps in the sequence described.

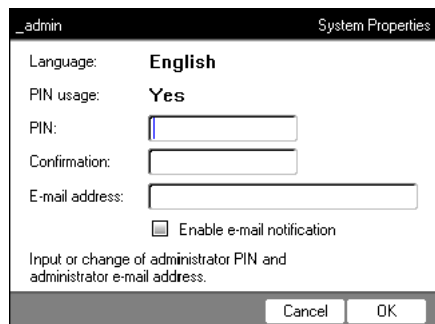

1. Switch on the Mastercycler nexus at the power switch. The *Input Admin PIN* window appears.
2. Enter the desired administrator PIN using the numeric keys.
3. Re-enter the PIN in the *Confirmation:* field.
4. An error message appears if the two PIN entries do not match. If this happens, delete the incorrectly entered PIN and reenter the PIN twice.
5. Optional: enter the administrator's e-mail address for receiving messages from the Mastercycler nexus in the *E-mail address:* field (see p. 83).
6. Optional: select *Enable e-mail notification* to activate e-mail notifications for the administrator.
7. Press the *OK* softkey.

After the successful confirmation of the administrator PIN, the navigation tree appears on the display. You are now logged in as the administrator.

5.2.2 Other steps

5.2.2.1 Changing the language

You can change the language of the user interface of the Mastercycler nexus (see *System settings on p. 72*).

5.2.2.2 Set date and time

The date and time are shown in the upper right corner of the display. As the administrator, you can change this internal clock at any time (see *System settings on p. 72*).

5.2.2.3 Setting up user accounts

To be able to use the Mastercycler nexus, you must set up at least one user account. Detailed information on user management and how to set up user accounts can be found separately (see *Managing user accounts on p. 69*).

5.3 Logging in and out as a user



The functions described here are only available if the PIN function is activated (see *System settings* on p. 72).

5.3.1 Logging in as a user

To be able to log in with your user name, your administrator must have set up a user account for you.

Proceed as follows:



1. Open the list by pressing the **enter** key, and select your user name.

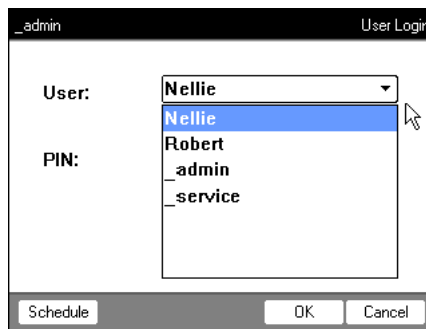

2. Press the **next** key.
The cursor jumps to the *PIN:* field.



3. Enter your PIN via the numerical keys.
If the PIN is wrong, *Wrong PIN* appears. Press the *Login* softkey to return to the *User Login* window, delete the wrong PIN entry with the *Delete* key, and enter the correct PIN.
4. Press the *OK* softkey to confirm.
The navigation tree is displayed.

You are now logged in with your user name and can work with the Mastercycler nexus.

5.3.2 Changing users

Only one user can be logged in at a time. Proceed as follows to switch between users:

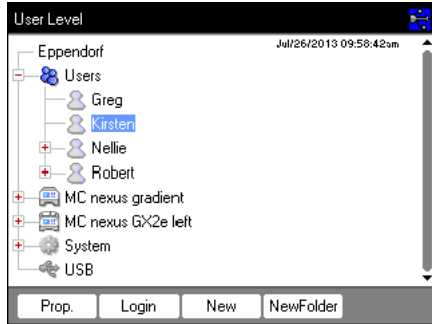

1. Select either your user node or the *Other Users* user node.
2. Press the *Login* softkey.
3. Log in as a user.
The previously logged-in user is automatically logged out.

5.3.3 Logging out as a user

You can log out to protect your programs against unauthorized changes.

1. Select your user node.
2. Press the *Logout* softkey.

You are now logged out.

The guest user is automatically logged in. The guest user cannot start programs and only has read access to all programs and folders.

5.4 Overview of software operation

5.4.1 Navigation tree overview

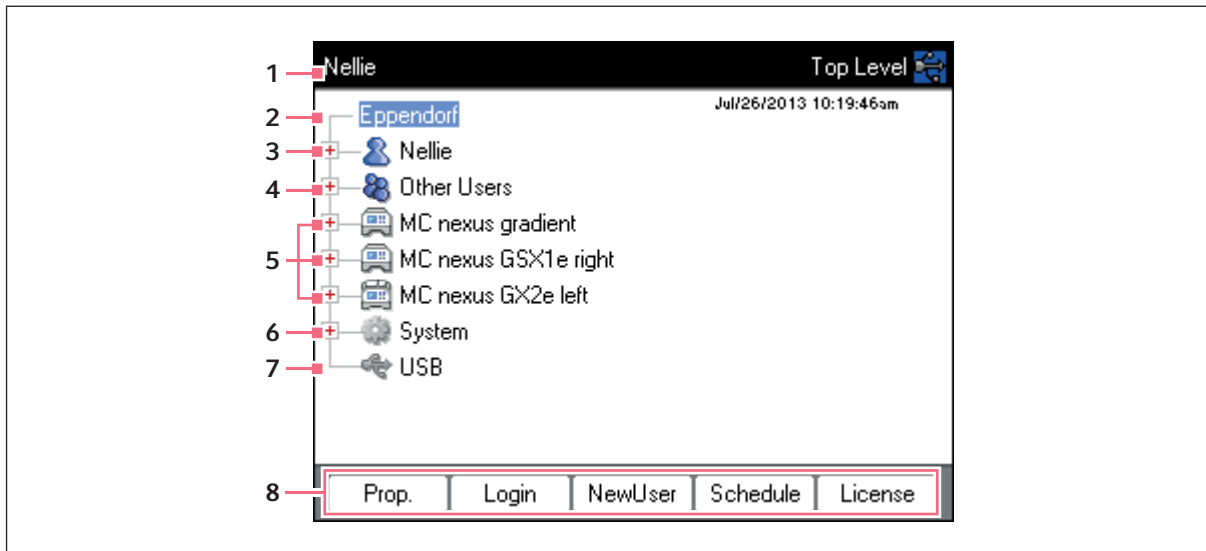

1 Window title

Current level in the navigation tree or title of a dialog box.

2 Eppendorf node

The main node which contains all other nodes.

3 User node

Contains the programs and folders as well as the list of the 5 most recently started programs of the logged-in user.

4 Other Users node

Contains the nodes of the users that are not currently logged in if PINs are used (see p. 72).

5 Cyclers node

Each cycler that is connected and switched on is shown as a separate node. The cycler node can be used to display the cycler status and execute functions.

6 System node

This node contains the most important system settings. Some settings can only be edited by the administrator.

7 USB node

This node is only visible if a USB storage medium has been inserted. Use this node to transfer programs and perform data backups.

8 Softkeys



The 5 softkeys have context-specific functions, depending on the selected node or active window.

5.4.2 Navigating in the navigation tree

5.4.2.1 Opening the node

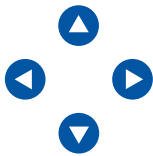
You have three options:



- ▶ Mark the node with the arrow keys and press the **enter** key or the  arrow key. The node opens and the  symbol changes to .



- ▶ Alternatively, click on the  symbol next to the node.







- ▶ Alternatively, use the mouse to double-click on the desired node.

5.4.2.2 Closing the node

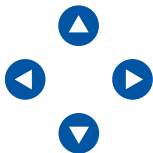
Carry out the above-mentioned steps in the reverse order:

- ▶ Click on the  symbol next to the node.
- ▶ Alternatively, double-click on the node with the mouse.



- ▶ Alternatively, mark the node with the arrow keys and press the **enter** key or the  arrow key. The node is closed and the  symbol next to the node changes to .

5.4.3 Using external storage media

You can back up programs, log files and protocols to a storage medium and, for example, archive them on a PC or print them. External storage media are also needed for data backups and software updates (see p. 72).

5.4.3.1 Connecting a USB storage medium

- ▶ Connect a USB storage medium to a USB port.

After a few seconds, the *USB* node appears in the navigation tree. The programs and user nodes saved on the USB storage medium can be accessed via this node.



The Mastercycler creates a folder called `\leppendorf` on the USB storage medium where all files will be saved.

5.4.3.2 Removing the USB storage medium

Caution! The  symbol is displayed in the upper right corner while the storage medium is being accessed. Wait until it has disappeared before removing the USB storage medium.

- ▶ Remove the USB storage medium.
 The *USB* node disappears from the navigation tree.

5.4.4 Selecting export file formats

When exporting programs, protocols and log files to external storage media, you can choose between text-only format (.TXT) and PDF.

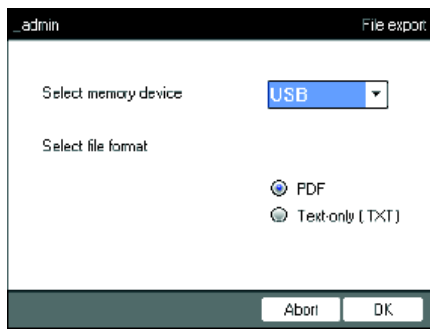

- ▶ *Select memory device*
 Storage medium for the exported file.
- ▶ *Select file format*
 - *PDF*: Saves the file as a PDF. Use this setting if you only want to print or view the documents on your PC. You need to have a PDF reader software installed (e.g. Adobe® Reader®).
 - *Text-only (.TXT)*: Saves the file in text-only format (.TXT). Use this setting if you want to process the document content electronically (e.g. embed it in a report).
- ▶ Confirm your selection with *OK*.

The file is copied to the external storage medium, and the file name is displayed.

5.5 Managing folders and programs



If you are logged in as a normal user (not as an administrator), you can only create, edit and delete programs below your own user node. Further information on user rights can be found in a separate section (see *Administrator functions on p. 69*).

5.5.1 Creating folders and programs

5.5.1.1 Creating a folder

Proceed as follows:

1. Mark the user node.
2. Press the *NewFolder* softkey.
3. Enter a name for the new folder using the numeric keys.



Instead of the numeric keys, you can also use the software keyboard to make entries in text fields. This can be accessed via the *Keybd* key.

The screenshot shows a dialog box titled "New Folder" within the "Nellie" application. The dialog has a "Name:" label and a text input field containing "folder01". Below it is a "Comment:" label and a larger text input field with vertical scroll bars. At the bottom, there are three buttons: "Keybd", "OK", and "Cancel".

4. To enter a comment for the new folder, use the **next** key to go to the *Comment:* field.
5. Enter your comment via the numerical keys and confirm with *OK*.

The folder is created and appears under your user node in the navigation tree.



You can change the name and comment for the folder at any time using the *Prop.* softkey.

5.5.1.2 Creating a new program

You can create programs in the navigation tree on the user node level or on the folder level.

1. In the navigation tree, mark the user node or folder where you want to create the new program.
2. Press the *New* softkey.

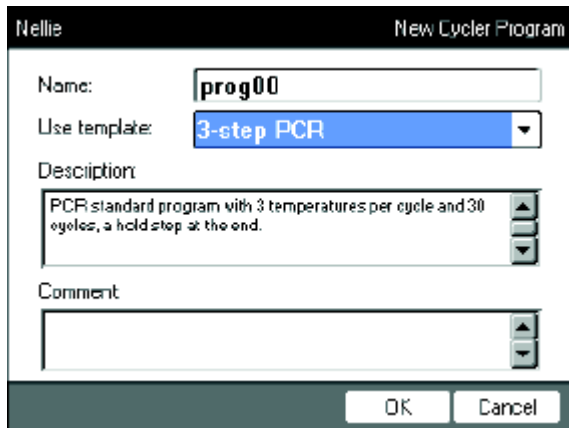

3. Enter the program name in the *Name:* field. The maximum number of characters is 21.
4. Select a program template in the *Use template:* field.
 An overview of the available program templates can be found separately (see p. 59). If you do not want to use a template, select *none*.
5. Optional: enter a comment for the new program in the *Comment* field.
6. Press the *OK* softkey.
 The new program opens in the program editor. You can now configure and save the program (see p. 49).



You can change the program properties at a later time. To do so, mark the program in the navigation tree and press the *Prop.* softkey. The following properties can be changed:

- Program name
- Comment for the program
- Read/write access rights for the program

5.5.2 Copying folders and programs

To copy folders or programs into your own user node, proceed as follows. When copying a folder, the programs it contains are also automatically copied.

1. In the user node of any user, mark the folder or program you want to copy.
2. Press the *Copy* softkey.
A message appears informing you that the folder or the program was copied to the clipboard.
3. Press *OK* to confirm the message.
4. Mark your own user node. If you want to copy an individual program, you can also select a folder under your user node to which you want to copy the program.
5. Press the *Paste* softkey.
If a program or folder already exists with the same name, you will be prompted to enter a new name. The folder or program is pasted below your user node. You can now start or edit this program.

5.5.3 Deleting folders and programs

1. In the navigation tree, mark the folder or the program.
2. Press the **del** key.
A confirmation prompt appears.
3. Press the *Yes* softkey.
The folder or program is deleted.

5.6 Using the schedule

The schedule enables users to reserve devices for a specific time. You can view the schedule at any time or use it as an automatic screensaver. Use the *System > Schedule Settings* node to set the devices and weekdays for the schedule. Past schedule entries are automatically deleted.



You can use the schedule as an automatic screensaver (see p. 72)

- ▶ Mark the  *Eppendorf* node. Press the *Schedule* softkey.
The *Mastercycler Schedule* window appears.

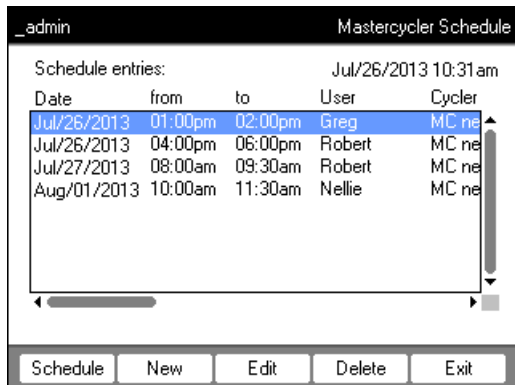

- Schedule* Display the schedule.
- New* Create a new schedule entry.
- Edit* Change the schedule entry for the logged-in user.
- Delete* Delete the schedule entry for the logged-in user.
- Exit* Close the window.

5.6.1 Editing a schedule entry

The following window appears if you choose to display, create or change a schedule entry:

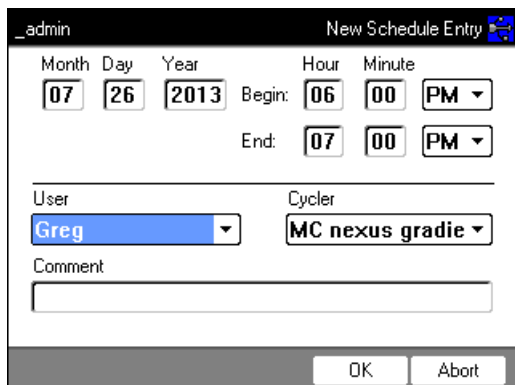

1. Complete the fields as follows.

- Day, Month, Year* Date of the reservation.
- Begin:* Start of the reservation.
- End:* End of the reservation.
- User:* Name of the respective user. Only users that have been set up can be selected.
- Cyclor* Reserved device.
- Comment* Optional: comment for the reservation.

2. Press the *OK* softkey.

The schedule entry appears in the list in the *Mastercycler Schedule* window.

5.6.2 Displaying the schedule

You can access the schedule from the *Mastercycler Schedule* and *User Login* windows.

 You can use the schedule as an automatic screensaver (see p. 72)

1. In the *Mastercycler Schedule* or *User Login* windows, press the *Schedule* softkey.
 The schedule is displayed on a day-to-day basis.

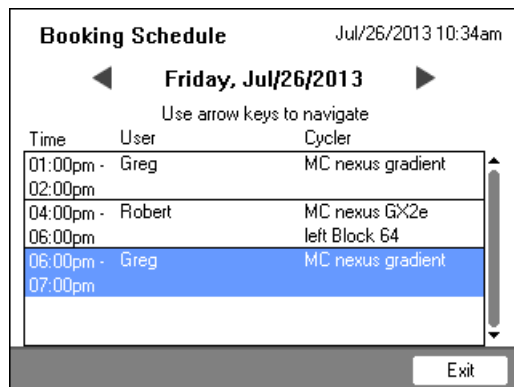

Time	User	Cyclor
01:00pm -	Greg	MC nexus gradient
02:00pm		
04:00pm -	Robert	MC nexus GX2e
06:00pm		left Block 64
06:00pm -	Greg	MC nexus gradient
07:00pm		

 Only days that have been activated by the administrator are displayed in the schedule(see p. 72).

2. Scroll to the left or right with the arrow keys to view the entries for other days.
3. Press the *Exit* softkey to exit the schedule.

5.7 Using the power save mode

You can use the power save mode to reduce power consumption when the device is in idle mode.

 The Mastercycler nexus eco automatically switches to power saving mode if the thermoblock and heated lid have not been tempered.

 The administrator can define that the Mastercycler nexus will automatically switch to the power saving mode (see p. 72).

Prerequisites

- No program and no temperature control is active.
- The program editor is not open.
- No error message is displayed.

Switching on the power save mode



- ▶ Press the standby key.
The device switches to power save mode.
- The display is switched off.
- The USB ports are switched off.
- The fan is switched off.
- The status lamp flashes green at long intervals.

Exiting the power save mode



- ▶ Press the standby key.
The device leaves the power save mode.
- The display is switched on.
- The USB ports are switched on.

6 Programming

6.1 Overview of the program editor

The graphic program editor can be used to view and change existing programs.

6.1.1 Opening the program editor

1. Mark the desired program in the navigation tree or create a new program.
2. Press the *Edit* softkey.

The program editor is displayed.

6.1.2 Structure of the program editor

A program consists of a program header and up to 99 program steps that are executed by the cycler one after the other. Use the program editor to create and adjust programs.

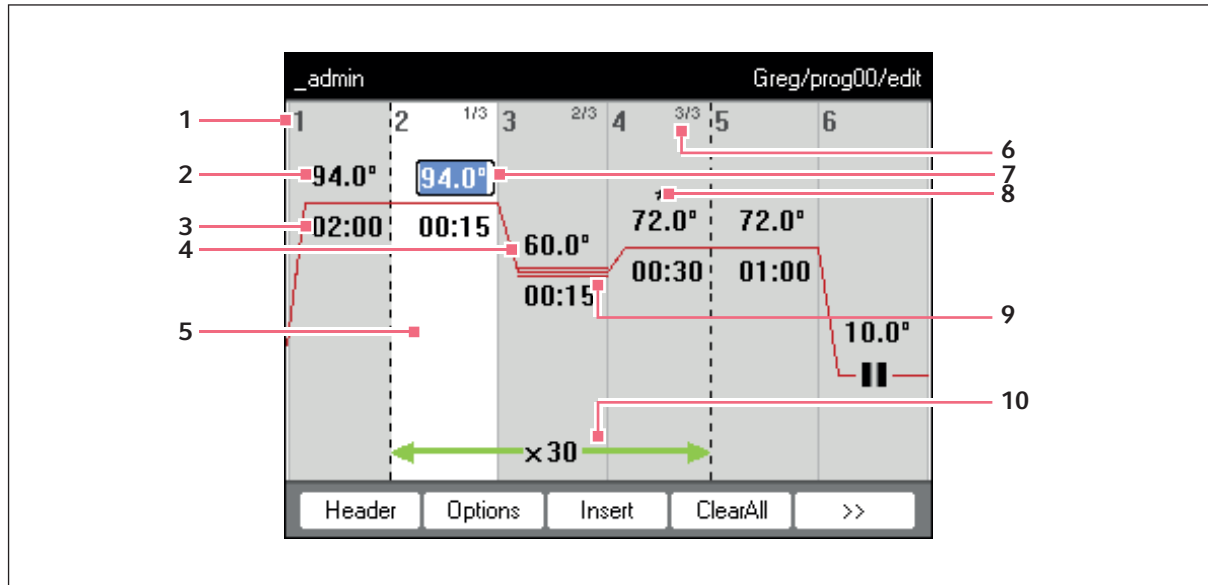

1 Number of the program step

2 Block temperature [°C]

The thermoblock is heated or cooled in the relevant step at this temperature.

3 Holding time [mm:ss]

The set block temperature is maintained for this time.

4 Average temperature for gradient steps

When using gradient steps, increasing temperatures are generated across the columns of the thermoblock from left to right. The average temperature is displayed here.

5 Program step highlighted marking

The selected program step is highlighted in blue. New program steps are inserted before the marked step.

6 Step number within the cycle

The step number within a cycle and the total number of steps in the cycle are displayed on the top right. Example: 2/3: second step of a 3-step cycle (3 StepCyc).

7 Active input field

Numerical keys are used to make entries.

8 Extended program step

Program steps are marked with a star * if they have a temperature or holding time increment or a reduced heating or cooling rate.

9 Marking of gradient steps

Gradient steps are indicated by three horizontal lines.

10 Number of cycles

The number of cycles indicates how often the program steps indicated by the green horizontal arrow are to be carried out.

6.2 Making general settings

Each Mastercycler nexus program has a program header where you define the block temperature control mode and the behavior of the heated lid. These settings are valid for the entire program.

6.2.1 Opening the header

1. Open the program editor (see *Opening the program editor on p. 49*).

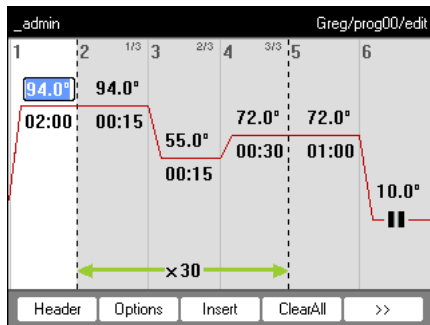

2. Press the *Header* softkey.

The header settings are displayed.

6.2.2 Editing header settings

<i>Lidtemp.</i>	<p>Heated lid temperature (37°C to 110°C). The set lid temperature is maintained constant during the program run. If values below 37°C are entered, the heated lid remains switched off.</p>
<i>TSP heated lid</i>	<p>Preheat heated lid</p> <ul style="list-style-type: none"> • Switch TSP on and off. <p>If the <i>TSP heated lid</i> function is activated, the heated lid is heated up to the set temperature upon program start while the block temperature is maintained constant at 20°C. The program run starts once the heated lid temperature has been reached.</p>
<i>switch off lid at low blocktemperature</i>	<p>Lid heater with automatic switch-off</p> <ul style="list-style-type: none"> • Activated (default setting): the lid heater switches off if program steps have block temperatures of < 15 °C. • Deactivated: the lid heater switches off after the end of the program. If the last command of the program is a hold step, the heated lid remains switched on until you press the Enter key. <p>Note: This option is useful if you have inserted a hold step as the last program step in order to automatically cool the samples after the PCR.</p>
<i>Temp. mode</i>	<p>Block temperature control mode</p> <ul style="list-style-type: none"> • <i>fast</i>: Use this setting for Fast PCR, for low reaction volumes (< 20 µL) and for templates with a low G/C content. With this setting you achieve the shortest program run times. • <i>standard</i>: block temperature control mode for standard applications. Use this setting for sample volumes between 20 µL and 50 µL or if the <i>fast</i> setting only results in a weak amplification. The program run times are slightly longer than with the <i>fast</i> setting. • <i>safe</i>: block temperature control mode for complex template and large reaction volumes. Use this setting for sample volumes of 50 µL or more or to amplify templates with a high G+C content. The program run times are slightly longer than with the <i>standard</i> setting.
<i>Simulate Mastercycler gradient</i>	<p>Simulate the temperature control behavior of the Mastercycler or Mastercycler gradient. This enables you to transfer programs from these cycler models to the Mastercycler nexus without making any adjustments (see <i>Transferring programs from an older Mastercycler model on p. 79</i>).</p> <p>If this option is deactivated, programs created for the Mastercycler will need to be adapted for the Mastercycler nexus because of different temperature behavior. This may influence the PCR results.</p>

6.3 Editing programs

You can add, edit or delete steps in new (see p. 43) or copied (see p. 44) programs.

6.3.1 Inserting a program step

1. Open the program editor (see *Opening the program editor on p. 49*).
2. Mark the program step with the arrow keys **in front of which** you would like to insert a new program step.

The marked program step is highlighted in blue.

3. Press the *Insert* softkey.

A list appears containing the available program steps.

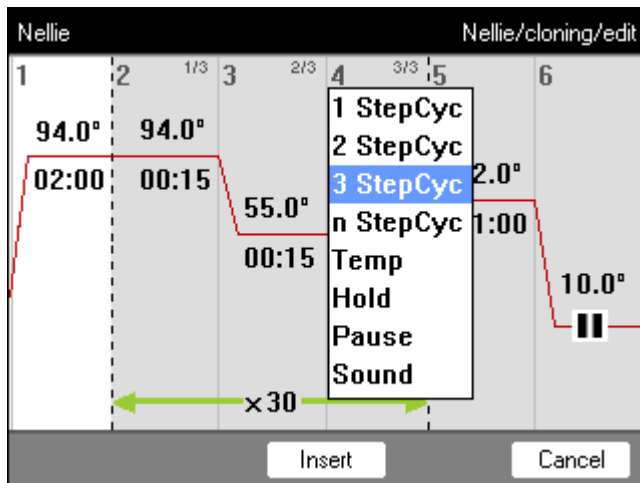

4. Select the desired program step with the arrow keys.

The following program steps are available:

<p>1 StepCyc to 3 StepCyc</p>	<p>Cycle program step with 1 to 3 temperature steps with an adjustable number of repetitions (1 to 99). With cycle program steps you can increase or reduce the block temperatures and holding times by a preset value after each cycle .</p>
<p>n StepCyc</p>	<p>Cycle program step with an adjustable number of temperature steps. After this program step has been selected and confirmed with enter, a dialog window for the following entries is displayed.</p> <ul style="list-style-type: none"> • <i>Steps per Cycle</i>: Number of temperature steps per cycle (1 to 40) • <i>Number of Cycles</i>: Number of cycles (1 to 99). If you have inserted a cycle with more than 6 steps, use the ◀ and ▶ arrow keys to view the steps that are not displayed.
<p>Temp</p>	<p>Individual temperature step with adjustable block temperature and holding time.</p>

<i>Hold</i>	Temperature step with adjustable block temperature and indefinite holding time. The set temperature is maintained until the user presses the enter key. A corresponding prompt is displayed in the status view and signaled by orange flashing of the status lamp.
<i>Sound</i>	This program step emits an acoustic signal.
<i>Pause</i>	As <i>Hold</i> . The block temperature remains set to the value of the previous temperature step.

- Press the *Insert* softkey.

The program step is inserted with standard parameters.



You can now insert additional program steps or edit the parameters of the program steps.

6.3.2 Editing parameters

- Mark the desired program step with the arrow keys.

The marked program step is highlighted in blue.

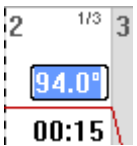
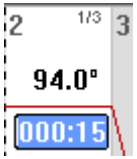
You can change the temperature, holding time and number of cycles directly in this view.

	Temperature	Adjustable from 4.0°C to 99.0°C (in 0.1°C increments)
	Dwell time	Adjustable from 000:00 to 999:59 (mmm:ss) in 1-second steps
	Number of cycles	Adjustable from 1 to 99

- Press the **enter** key to accept the changes.

Extended options

- Press the *Options* softkey.

The extended parameter settings for the marked program step are displayed.

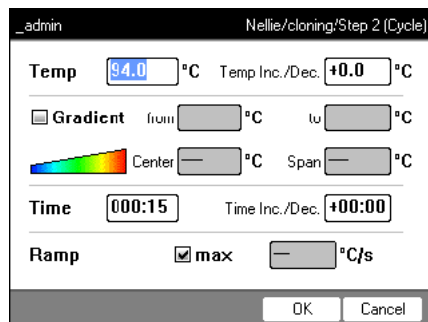

_admin Nellie/cloning/Step 2 (Cycle)
 Temp °C Temp Inc./Dec. °C
 Gradient from °C to °C
 Center °C Span °C
 Time Time Inc./Dec.
 Ramp max °C/s

<i>Temp</i>	Temperature of the program step
<i>Temp Inc./Dec.</i>	Temperature change from one cycle to the next Adjustable from -10.0°C to $+10.0^{\circ}\text{C}$ in 0.1°C increments. You can switch between positive and negative values by pressing the +/- softkey.
<i>Gradient</i>	Temperature gradient in the thermoblock, displayed as columns Detailed information on how to program a gradient step can be found in a separate section (see p. 55).
<i>Time</i>	Holding time for the program step
<i>Time Inc./Dec.</i>	Holding time change from one cycle to the next Adjustable from $-01:00$ to $+01:00$ in 1 s increments. You can switch between positive and negative values by pressing the +/- softkey.
<i>Ramp</i>	Temperature control speed of the thermoblock Aluminum thermoblock: adjustable from 0.1°C/s to 1.5°C/s . Silver thermoblock: adjustable from 0.1°C/s to 3.0°C/s . Alternatively, <i>max.</i> can be set. If you select <i>max.</i> , the maximum heating and cooling speeds specified in the Technical Data will be used.

4. Press the *OK* softkey to accept the settings.
The program view appears.
5. Press the >> softkey. Press the *Save* softkey.
The changes are saved.
6. Press the *Exit* softkey to exit the editor.

6.3.3 Create gradient step

You can use a gradient step to optimize the specificity and yield in PCR reactions. A temperature gradient increasing from the left to the right side of the block is generated during the holding time. The temperature control rates before and after the gradient step are constant over the entire thermoblock.



Details about the maximum gradient spread can be found in the product description (Tab. on p. 23).

The gradient function is only available to the following devices:

- Mastercycler nexus gradient
- Mastercycler nexus gradient eco
- Mastercycler nexus GSX1
- Mastercycler nexus GSX1e
- Mastercycler nexus flat
- Mastercycler nexus flat eco
- Mastercycler nexus GX2 (Gradient function only for thermoblock with 64 wells)
- Mastercycler nexus GX2e (Gradient function only for thermoblock with 64 wells)

Proceed as follows to define a gradient step in a PCR program:

1. Mark the temperature control step in which you would like to define the gradient.
2. Press the *Options* softkey.

The options for the selected temperature control step are displayed.

3. Select the *Gradient* checkbox.
4. Define the gradient temperatures.

The gradient temperatures can be defined in two ways:

- By entering limit temperatures
 - *from*: lower limit temperature (left side of block)
 - *to*: lower limit temperature (left side of block)
- By entering the center temperature and the temperature span
 - *Center*: center temperature (center of block)
 - *Span*: temperature span (gradient range)

5. Optional: Press the *Edit Grad.* softkey to display the resulting temperatures in block columns.

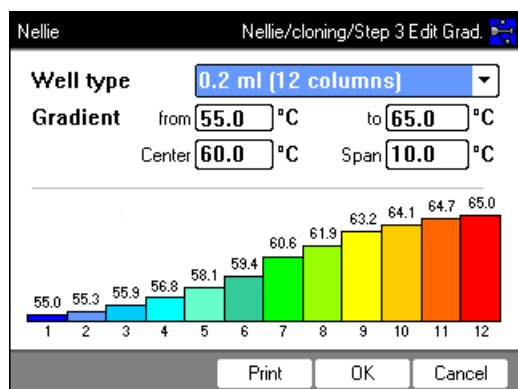

Well type	Select the tube type: <ul style="list-style-type: none"> • 0.2 ml (12 columns): standard PCR tubes and 96-well plates • 0.5 ml (11 columns): 0.5 mL PCR tubes • 0.2 ml GSX1 (12 columns): 0.2 mL PCR tubes • 0.2 ml GX2 (8 columns): 0.2 mL PCR tubes • 0.5 ml GX2 (7 columns): 0.5 mL PCR tubes
Gradient	Gradient temperature

6. Press the *OK* softkey to accept the settings and close the window.
 The gradient step is symbolized in the program editor by three horizontal lines.

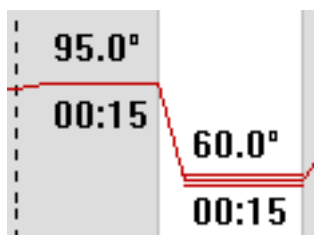

6.3.4 Deleting program steps

1. Mark the desired program step with the arrow keys. To delete all program steps, press the *ClearAll* softkey.
2. Press the **del** key.
3. Press the *Save* softkey to save the change.

Press the *Exit* softkey to exit the editor.

6.3.5 Exporting a program as a PDF or text file

You can export a program to an external storage medium as a file for archiving.

1. Connect a storage medium (see p. 40).
2. Press the **>>** softkey.
3. Press the *Export* softkey.
4. Select the file format (text or PDF). Press the *OK* softkey.
 The program is saved to the external storage medium as a file.

6.3.6 Saving a program and exiting the editor

1. Press the `>>` softkey.
2. Press the *Save* softkey.
The program is saved.
3. Press the *Exit* softkey.

The navigation tree is displayed. You can now start the program (see *Starting a program on p. 63*).

6.4 Program templates

The following table provides an overview of the program templates. The program templates can be used to create new programs.

Program template	Description
<i>none</i>	Empty template with standard header settings.
<i>2-step PCR</i>	Standard PCR program with two temperatures per cycle and 30 cycles, one hold step at the end.
<i>3-step PCR</i>	Standard PCR program with three temperatures per cycle and 30 cycles, one hold step at the end.
<i>Cycle sequencing</i>	Standard program for cycle sequencing with ramp rates of 1 °C/s.
<i>Fast PCR</i>	3-step PCR with short hold times and temperature mode <i>fast</i>
<i>Gradient PCR</i>	PCR program with a temperature gradient in the annealing step of each cycle.
<i>Hot start PCR manual</i>	PCR program with thermoblock preheating at 95 °C. Start the following PCR run using the start key.
<i>Hot start PCR</i>	10 min enzyme activation at 95 °C and 3-step PCR.
<i>Incubation</i>	IsoTherm incubation.
<i>Large volume PCR</i>	3-step PCR in <i>safe</i> temperature mode.
<i>Long range PCR</i>	3-step PCR with 10 min elongation and a time interval of +10 s per cycle.
<i>Low volume PCR</i>	3-step PCR in <i>fast</i> temperature mode.
<i>Mastercycler 533x</i>	3-step PCR with simulation of the temperature control behavior of the Mastercycler gradient 5331.
<i>Nested cycles</i>	Program in which 3 cycles, with 3 temperatures each, are summarized in a 9-StepCycle, e.g., for TAIL PCR.
<i>Reduced Ramping</i>	3-step PCR with ramp rates of 1 °C/s.
<i>Reverse Transcription</i>	Incubation for reverse transcription and enzyme activation.
<i>RT-PCR</i>	Program for 1-step RT-PCR with series incubation for reverse transcription.
<i>Touchdown PCR</i>	PCR program with falling annealing temperature. During the first 16 cycles, the annealing temperature will be decreased by 1 °C per cycle.

7 PCR run

7.1 Loading the thermoblock

7.1.1 Selecting the sample tubes



WARNING! Biohazard due to unsuitable reaction vessels, plates and lids.

Unsuitable reaction vessels, plates and lids will get damaged in the Cycler. This will release sample material.

- ▶ Only use reaction vessels, plates and lids that meet the requirements specified in the operating manual.

7.1.1.1 Approved sample tubes for devices with a 96-well thermoblock

The thermoblock can be loaded with the following sample tubes:

- 0.1 mL PCR tubes
- 0.2 mL PCR tubes
- 0.5 mL PCR tubes (only for aluminum thermoblock)
- PCR tube strips (0.1 mL or 0.2 mL)
- 96-well PCR plates
- segments of separable 96-well PCR plates

7.1.1.2 Approved sample tubes for devices with a 64+32-well thermoblock

The thermoblock can be loaded with the following sample tubes:

- 0.1 mL PCR tubes
- 0.2 mL PCR tubes
- 0.5 mL PCR tubes
- PCR tube strips (0.1 mL or 0.2 mL)
- 64 and 32-well PCR plates
- segments of separable 96-well PCR plates

7.1.1.3 Approved sample tubes for devices with a flat thermoblock

Up to 4 slides

7.1.1.4 Compatible PCR plate types

The following PCR plate types are compatible. A selection of the PCR micro test tubes and lids can be found separately (see *Consumables on p. 107*).

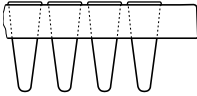
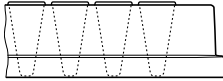
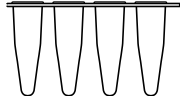
Semi-skirted PCR plate	Skirted PCR plate	Non-skirted/unskirted PCR plate
		
PCR plate with surrounding half-edge.	PCR plate with a surrounding edge.	PCR plate without any surrounding edge.

7.1.1.5 Requirements

The sample tubes must meet the following requirements:

- Temperature resistance at least 120°C
- Exact fit in the thermoblock

7.1.1.6 Maximum volumes

The possible sample volumes can vary depending on the tubes used.

For devices with an aluminum thermoblock

- PCR plates and 0.1 mL or 0.2 mL PCR tubes: max. 70 µL
- 0.5 mL PCR tubes: max. 100 µL

For devices with a silver thermoblock

- PCR plates and 0.1 mL or 0.2 mL PCR tubes: max. 100 µL

7.1.2 Inserting the sample tubes



WARNING! Biohazard due to sample material directly in the thermoblock.

- ▶ Do not fill sample material directly into the thermoblock.
- ▶ Only use reaction vessels, plates and lids that meet the requirements specified in the operating manual.



WARNING! Biohazard when tempering with the heated lid open.

When tempering with an open heated lid, the lids of the reaction vessels can spring open. This will release sample material.

- ▶ Only temper with a closed heated lid.

Observe the following notes when loading the thermoblock with tubes

- ▶ Place the tubes or strips into the center of the thermoblock and ensure that they are symmetrically positioned. This is applicable for individual tubes, ube strips and segments of separable PCR plates.
- ▶ Load the 96-well thermoblock with at least 5 tubes. If you have fewer reaction batches, also add empty tubes so the thermoblock is loaded with at least 5 tubes.
- ▶ Load the 64+32-well thermoblock with at least 2 tubes. If you have fewer reaction batches, also add empty tubes so the thermoblock is loaded with at least 2 tubes.



Very soft PCR tubes may become deformed at high temperatures. To prevent deformations:

- Increase the number of empty sample tubes in the thermoblock.
- Reduce the temperature of the heated lid (see p. 52).
- Use original Eppendorf PCR consumables. Eppendorf PCR consumables are optimally suited for the device.

7.2 Starting a program



If the *PIN* function is activated, you can only start programs that are saved below your user node (see p. 69).

Prerequisites

- Thermoblock loaded (see p. 61)
- Heated lid closed (see p. 34)

1. Mark the program in the navigation tree with the arrow keys or open it in the editor.
2. Press the **start** key.

If multiple cyclers are available, the *Cycler Selection* window appears.

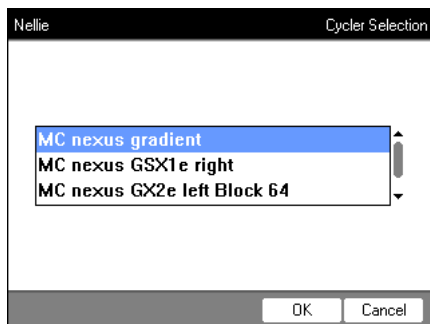

3. Mark the desired cycler.
4. Press the *OK* softkey.

The program is started and the status view appears.

7.2.1 Status view

The status view is automatically displayed immediately after a program is started. It shows the progress of and information on a running program. The currently active step is displayed as a flashing line.

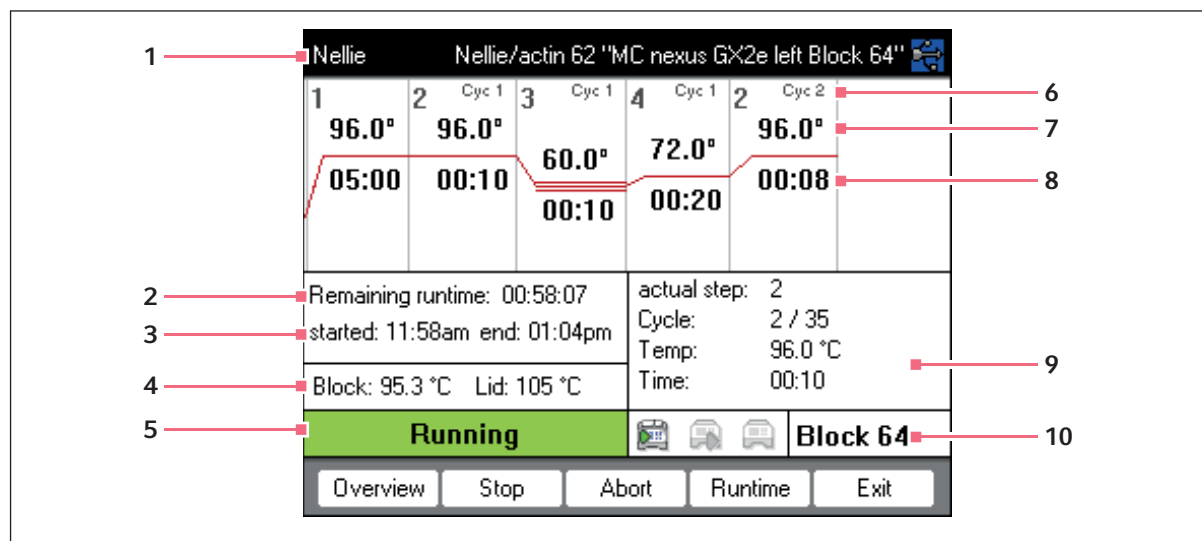

- | | |
|-------------------------------------|---|
| 1 User, program name and cycler | 6 Cycle number |
| 2 Remaining run time | 7 Block target temperature |
| 3 Start and end time of the program | 8 Remaining holding time |
| 4 Block and heated lid temperature | 9 Information on the current program step |
| 5 Device status | 10 Specification of the selected cycler |



If you have activated the *TSP* function in the program header (see p. 51), the heated lid is first brought to the correct temperature before the program run starts. This process is indicated in the status view by the message *TSP heated lid*.





You can exit the status view and return to the navigation tree at any time by pressing the *Exit* softkey, e.g. to edit another program or start a program on a different cycler. Use the left/right arrow key to access the status view of other connected cyclers. The program that was already started is not interrupted as a result.

7.2.1.1 Displaying the status view

Proceed as follows:

1. Mark the cyclers in the navigation tree.
2. Press the *Status* softkey.

The status of the cyclers is shown with an icon:

-  Idle
-  Running
-  Paused
-  Fault

7.2.2 Common status view for devices with a thermoblock with 64+32 wells

The common status view shows the progress and most important information on the running programs of both thermoblocks.

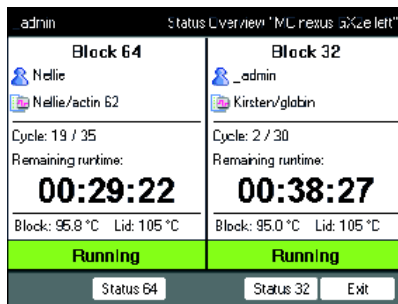

You can display the status views of the individual programs via the *Block 64* and *Block 32* softkeys.

The status views of the individual programs can be accessed via the up/down arrow keys.

Use the right/left arrow keys to call up the common status views of other connected cyclers.

To open the common status view, proceed as follows:

1. Mark the cyclers in the navigation tree.
2. Press the *Overview* softkey.



The common status view can also be opened via the *Overview* softkey in the status view of the respective program.

7.3 Interrupting or stopping a program

7.3.1 Interrupting a program

1. Open status view (see *Starting a program on p. 63*).
2. Press the **stop** key.

Paused is displayed in the status view.

7.3.2 Resuming a program

1. If the heated lid is open: close the heated lid.
2. Press the *Resume* softkey.

running appears in the status view, and the program run continues.

7.3.3 Stopping a program

- ▶ Press the *Abort* softkey.

The *Idle* status is displayed. The program has been aborted and cannot be continued.





A hold step at the end of a PCR program is completed via the **enter** key. In the common status view, you can end the PCR program out of a hold step via the *End 64* or *End 32* softkeys.

7.4 Displaying the most recently run programs

The device can display a list of the 5 most recently run programs.

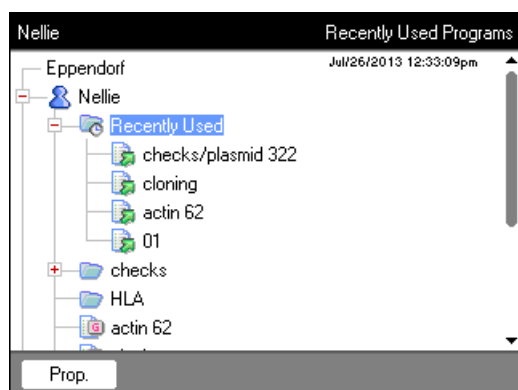
If the *PIN* function is switched on and a user is logged in, the  *Recently Used* node is positioned in the user node.



If the *PIN* function is switched off or the administrator is logged in, the  *Recently Used* node is located below the  *Eppendorf* node.

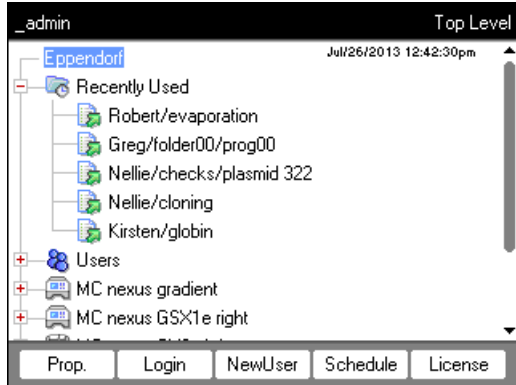

If no user is logged in, the  *Recently Used* node is not available.

The following functions are available:

Key: start	Start the last run program.
Softkey: <i>Prop.</i>	Display the properties of the last run program.
Softkey: <i>Edit</i>	Edit the last run program.
Softkey: <i>Copy</i>	Copy the last run program.
Softkey: <i>Export</i>	Export the last run program.

8 System management

8.1 Administrator functions

The Mastercyclers nexus software differentiates between default users and the administrator. All users and the administrator need a PIN to log into the device. Users can only make changes to their own accounts. The administrator has write access to all areas. If you deactivate the PIN function, all users automatically have administrator rights and can make changes to all user accounts (see p. 72).

The access rights differ as follows:

Procedure	Default users	Administrator
Copying programs	From each user node to own user node	From each user node to each user node
Creating, deleting, editing and starting programs	Only programs below their own user node	All programs
Managing user accounts and generating PINs	Only change own user name and PIN	Create, change, delete user accounts. Change the PIN for each user.
Making system settings	None	All
Performing the self test, verification and adjustment	Self test and verification only	Self test, verification and adjustment
Performing backups, restores and software synchronizations	Only backups	All

8.2 Managing user accounts



- A user name can only be assigned once.
- The administrator uses the set user name `_admin`.

8.2.1 Creating a user account

Prerequisites

If the PIN function is activated: logged in as an administrator

You can set up a user account for each user:

1. In the navigation tree, mark the *Eppendorf* node (at the top).
2. Press the *NewUser* softkey.

The *New User* window appears.

3. Enter the name and PIN of the new user. Re-enter the PIN in the *Confirmation:* field.
4. Optionally enter the user's e-mail address in the *E-mail address:* field. To activate e-mail notifications, check the *Enable e-mail notification* checkbox.
5. Press the *OK* softkey.
The new user account is created. A new user node with this user name is created in the navigation tree. The user can now log in with his PIN.

8.2.2 Editing a user account

If you have the appropriate user or administrator rights, you can change the following data of existing user accounts:

- PIN
- E-mail address
- Comment

1. Mark the user node in the navigation tree. Press the *Prop.* softkey.
The *User Properties* window appears.
2. Change the settings for the user account. Press the *OK* softkey.

8.2.3 Deleting a user account

You must be logged in as an administrator to be able to delete user accounts.



Deleting a user account will delete the respective user node including all folders and programs it contains. Deleting a user account is a permanent change and cannot be undone.

1. Mark the user node. Press the **del** key.
A query appears whether you really want to delete the user account.
2. Press the *OK* softkey.
The user account is deleted.

8.2.4 Changing the administrator PIN

If you are logged on as an administrator, you can change the administrator PIN at any time.



NOTICE! Data loss due to unauthorized use of the administrator password.

The administrator password protects the device software from unwanted access.

- ▶ Make a note of the administrator password.
- ▶ Keep the administrator password at a secure location.
- ▶ Only provide the administrator password to individuals who work with the system configuration.
- ▶ Please contact Eppendorf AG if you have any problems with the administrator password.

-
1. Switch on the Mastercycler nexus and log in as the administrator.
 2. Mark the *System* node. Press the *Prop.* softkey.
The *System Properties* window appears.
 3. Enter the new administrator PIN using the numeric keys.
If you have entered the PIN incorrectly, delete it with the **del** key and re-enter the PIN.
 4. Re-enter the new PIN in the *Confirmation:* field to confirm.
 5. Press the *OK* softkey.
The new administrator PIN is immediately valid.

8.3 System settings

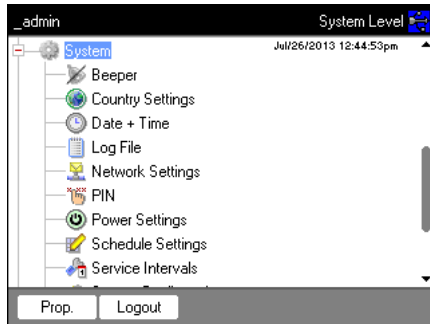

- ▶ To change the system settings, open the *System* node.

<p><i>Beeper</i>: Activate or deactivate signal tones</p>	<ul style="list-style-type: none"> ▶ Activate or deactivate the <i>Beeper</i> node. If the function is activated, the signal tones sound when keys are pressed and when error messages are generated. If the function is deactivated, the signal tones only sound when error messages are generated.
<p><i>Country Settings</i>: Change country settings</p>	<p>The country settings are identified by the international dialing code (e.g. "001" for the U.S.). The language as well as the date and time format (12 or 24 hour format) are defined in the country settings.</p> <ol style="list-style-type: none"> 1. Mark the <i>Country Settings</i> node. Press the <i>Set</i> softkey. 2. Select the desired settings. Press the <i>OK</i> softkey. <p>The device restarts.</p>
<p><i>Date + Time</i>: Set the date and time</p>	<ol style="list-style-type: none"> 1. Mark the <i>Date + Time</i> node. Press the <i>Set</i> softkey. 2. Set the date and time. Press the <i>OK</i> softkey.
<p><i>Log File</i>: Export log file</p>	<ul style="list-style-type: none"> ▶ Mark the <i>Log File</i> node. Press the <i>Export</i> softkey. The log file is written to the storage medium. ▶ Optional: to display the log file, mark the <i>Log File</i> node. Press the <i>Show</i> softkey.
<p><i>Network Settings</i>: Change network settings</p>	<p>Set up a network connection (see <i>Network connection on p. 81</i>).</p>
<p><i>PIN</i>: Activate or deactivate PIN</p>	<ul style="list-style-type: none"> ▶ Activate the <i>PIN</i> function (user management) with the <i>Select</i> softkey; deactivate it with the <i>Unselect</i> softkey. <p>The device restarts.</p>
<p><i>Power Settings</i>: Configure the automatic power save mode</p>	<p>Use the <i>Power Settings</i> node to define whether and when the device automatically enters the power save mode.</p> <ol style="list-style-type: none"> 1. Mark the <i>Power Settings</i> node. Press the <i>Set</i> softkey. 2. To activate the automatic power save mode, check the <i>Enable automatic standby</i> checkbox. 3. Set the time after which the device should automatically switch to power save mode in the <i>Enter standby mode after (hh:mm)</i> field. Press the <i>OK</i> softkey.

<p><i>Schedule Settings</i>: Make schedule settings</p>	<p>Use the <i>Schedule Settings</i> node to configure the schedule view and selection options.</p> <ul style="list-style-type: none"> ▶ Mark the <i>Schedule Settings</i> node. Press the <i>Set</i> softkey. • Check the <i>Enable Screensaver</i> checkbox to use the schedule as a screensaver. Set the time after which the screensaver should be activated in the <i>Wait [s]</i> field. • To select the weekdays that should be displayed in the schedule, check the corresponding boxes for <i>In schedule day view the following weekdays are displayed</i>. • To select the device types that should be displayed in the schedule, check the corresponding boxes for <i>In the schedule editor the following cyclers are enabled</i>. <p>▶ Press the <i>OK</i> softkey.</p>
<p><i>Service Intervals</i>: Setting intervals for temperature verification and self-test</p>	<p>You can determine intervals for a regular temperature verification or self-test via the <i>Service Intervals</i> node.</p> <ul style="list-style-type: none"> ▶ Mark the <i>Service Intervals</i> node. Press the <i>Verification or Self-test</i> softkey. You can set the intervals in the following display. • Specification of months (1 – max. 24) • Specification of programs run (1 – max. 2000) <p>The following details are shown on the display for each cycler:</p> <ul style="list-style-type: none"> • The programs run since the last verification or self-test • The date of the next check <p>You can also find this information under the <i>Block</i> (see p. 76) cycler system functions.</p> <p>You are informed via an info message before the defined intervals expire. The info message contains details about the remaining days or program runs until the interval expires. If email dispatch is activated (see p. 83), the administrator receives a corresponding message.</p> <p>When the intervals expire, a temperature verification or self-test must be carried out. Alternatively, you can deactivate the interval setting.</p>

<p><i>System Configuration</i>: Set device-dependent entries for ramp and gradient</p>	<p>Making changes under <i>System Configuration</i> is only necessary if you operate different variants of master and eco devices together.</p> <ul style="list-style-type: none"> ▶ Mark the <i>System Configuration</i> node. Press the <i>Set</i> softkey. ▶ Set entries for the ramp. <ul style="list-style-type: none"> • For devices with an aluminum thermoblock, select Mastercycler nexus. Adjustable value range: 0.1 - 1.5 °C/s or <i>max.</i>. • For devices with a silver thermoblock, select Mastercycler nexus SX1. Adjustable value range: 0.1 - 3.0 °C/s or <i>max.</i>. ▶ Set entries for the gradient spread. <ul style="list-style-type: none"> • Select the setting 20°C for devices with the 96-well thermoblock, which have a gradient function. If the setting Off is selected, no gradients can be programmed and the corresponding programs cannot be started. • Select the setting 12°C for devices with the 64+32-well thermoblock, which have a gradient function. If the setting Off is selected, no gradients can be programmed and the corresponding programs cannot be started. • Use the <i>Show well types</i> checkboxes to define which well types are displayed under <i>Edit Grad.</i> (see p. 55).
<p><i>User Log File</i>: Display or export user data</p>	<p>Use the <i>User Log File</i> node to export or display all performed actions as a log file. The following data can be displayed or exported:</p> <ul style="list-style-type: none"> • Login and logout procedures • Changes to and interventions in running programs • Update of the software version • Creating and deactivating service intervals <p>▶ Mark the <i>User Log File</i> node. Press the <i>Show</i> softkey. The next window enables you to print or export the log file.</p> <ul style="list-style-type: none"> ▶ Press the <i>Export</i> softkey to export the log file. ▶ Press the <i>Print</i> softkey to print the log file.

8.4 Cyclers functions

The  cycler nodes enable you to view and adjust the status of the thermoblock and the heated lid and access the protocols of the last 20 programs.

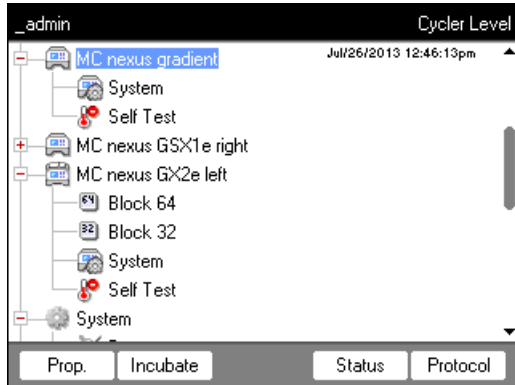

The softkeys have the following functions:

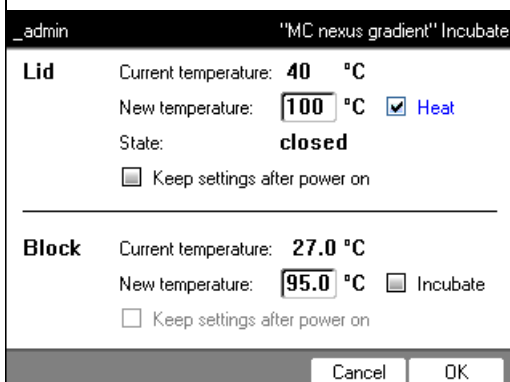
<i>Prop.</i>	<ul style="list-style-type: none"> • Change the name of the cycler node. The name must not contain any special characters. • Display the installed firmware version • Display the last logged-in user • Display the last run program
<i>Incubate</i>	<p>Display and change the current temperature of the heated lid and the thermoblock.</p>  <ul style="list-style-type: none"> • <i>Current temperature</i>: Display the current temperature • <i>New temperature</i>: Set the target temperature • <i>Heat/Incubate</i>: Control the temperature of the heated lid/thermoblock • <i>Keep settings after power on</i>: Automatically keep the current temperature control setting when the cycler is idle. This setting will remain unchanged even after a cycler restart. It can only be changed by an administrator.

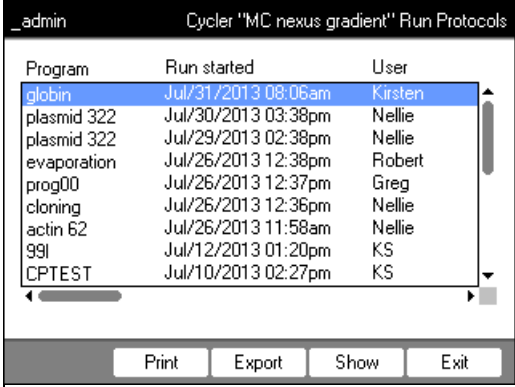
<i>Status</i>	<ul style="list-style-type: none"> • Display the cyclers operating status • Display the temperatures of the thermoblock and the heated lid • Display the remaining run time for the program • Stop the program
<i>Protocol</i>	<p>Protocols of the last 20 program runs:</p>  <p> ▶ Select the protocol via the arrow keys. <ul style="list-style-type: none"> • <i>Print</i> softkey: print the protocol • <i>Export</i> softkey: copy the protocol to a storage medium • <i>Show</i> softkey: display the protocol </p>



The following applies to devices with a thermoblock with 64+32 wells:
 The Cycle functions comprise the *Properties*, *Overview*, *Status 64* and *Status 32* softkeys.
 The *Incubate* and *Protocols* softkeys are located under the subnodes *Block 64* or *Block 32*.

8.4.1 Cyclers system functions

The *System* node contains the cycler system level with the following softkeys.

<i>Info</i>	<ul style="list-style-type: none"> • Display the device name • Display the date of the last verification • Display the date of the last verification • Display the programs run (since the last verification) • Display the date of the last self-test • Display the date of the next self-test • Display the programs run (since the last self-test) • Display the date of the last adjustment <p>Details about the next verification or self-test are only given if the settings have been made under <i>Service intervals</i> (see p. 72)).</p>
<i>Restart</i>	<p>Entry for maximum duration of interruption of voltage supply (<i>mm:ss</i>) after which a running program should be automatically restarted. The program is not restarted after a longer interruption.</p>

<i>Sensors</i>	Display current sensor temperatures for the control loops of the thermoblock and the heated lid.
<i>Verification</i>	Verify temperature accuracy and temperature homogeneity of the thermoblock with the Eppendorf Temperature Verification System.
<i>Adjustment</i>	Adjust temperature accuracy and temperature homogeneity of the thermoblock with the Eppendorf Temperature Verification System. Can only be done by the administrator.



The Eppendorf Temperature Verification System is required for the *Verification* and *Adjustment* functions (see *Accessories on p. 106*). For information on how to use this system, refer to the corresponding operating manual.

8.4.2 Self-test

The self-test function allows you to perform a quick check regarding the following attributes of the thermoblock without requiring an external measurement system:

- Heating and cooling rates
- Proper functioning of the thermoregulation circuits
- Temperature homogeneity in each of the three block zones and across the entire block

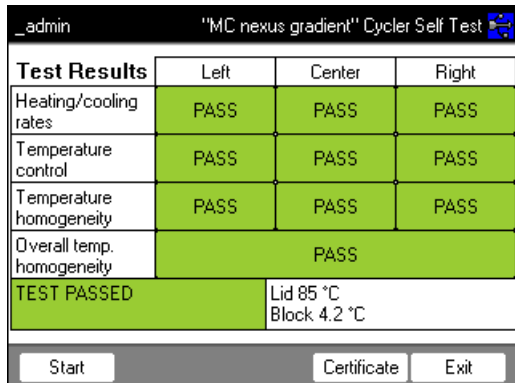

After a successful self-test, a certificate can be generated in PDF format.

A separately available self-test USB key is required for performing the self-test (see *Accessories on p. 106*). Please refer to the documentation of the self-test USB key for a detailed description of the self-test function.

8.5 Managing and backing up data

8.5.1 Backing up data

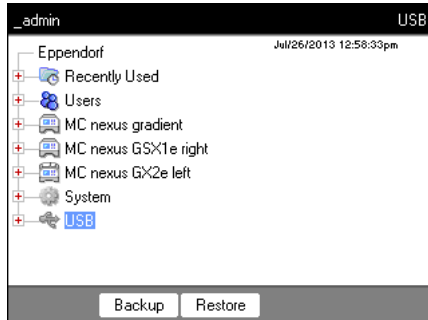

The softkeys in the window above show the possibilities the administrator has to transfer data. Default users can only perform backups here.



NOTICE! Loss of data after creation and restoration of a data backup.

- ▶ Creating a data backup on a USB storage medium: Before the backup is created, the \eppendorf folder on the USB storage medium is completely erased.
- ▶ Restoring a data backup: Before the data backup is restored, already existing user nodes, folders and programs on the cyclers are erased. Only the data transferred from the storage medium will be available after the restore.

1. Connect a storage medium.

The node for the storage medium appears in the navigation tree.

2. Mark the node for the storage medium.

<i>Backup</i>	Save user nodes, folders and programs to an external storage medium.
<i>Restore</i>	Administrator only: Restore the user nodes, folders and programs saved on the storage medium during a backup.

8.5.2 Exporting and importing programs

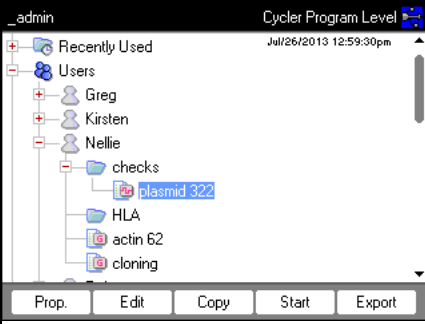
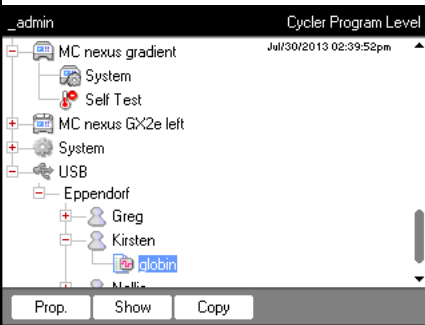
<p>Export</p>	 <ol style="list-style-type: none"> 1. In the navigation tree, mark the program. 2. Connect a storage medium. 3. Press the <i>Export</i> softkey. The program is copied to the storage medium. <p>You can transfer the exported programs to another device.</p>
<p>Import</p>	 <ol style="list-style-type: none"> 1. Connect the storage medium with the exported programs. 2. Open the node for the storage medium and mark the folder or program you would like to import. 3. Press the <i>Copy</i> softkey. 4. Mark the user node or folder at the target location. Press the <i>Paste</i> softkey.

8.6 Transferring programs from an older Mastercycler model

PCR programs from older Mastercycler models can easily be transferred to the Mastercycler nexus without optimization of the temperatures and holding times.

- ▶ Enter the program into the Mastercycler nexus editor:

Gradient protocol on the Mastercycler gradient and analog setting on the Mastercycler nexus gradient

- ▶ Enter the program into the Mastercycler nexus editor:

System management

Mastercycler® nexus
English (EN)

Example

```

1 T = 94.0°           0:02:00
2 T = 94.0°           0:00:15
3 T = 60.0°           0:00:15
+0.0°                 +0:00
R = 3.0°/s            +0:0°/s
G = 10.0°
4 T = 72.0°           0:00:30
5 GOTO 2              REP 29
6 T = 72.0°           0:02:00
7 HOLD 4.0°          ENTER

```

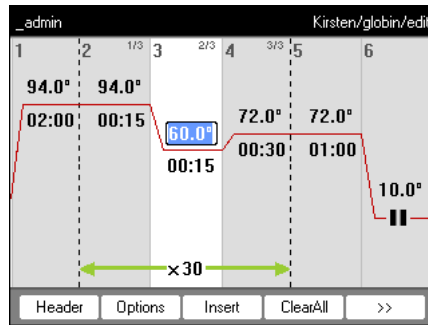

For the Mastercycler nexus you need to enter the gradient spreads.

A gradient setting of **G = 10.0°** for the Mastercycler gradient corresponds to a gradient spread of **20.0°C** for the Mastercycler nexus gradient. Enter this value in the *Span* field.

- ▶ Make the desired settings in the header (see *Editing header settings on p. 52*).

Setting from the Mastercycler 533x program	Corresponding setting in the program header
LID 105°C	<i>Lidtemp.</i>
WAIT \triangle	<i>TSP heated lid</i>
AUTO \triangle	<i>switch off lid at low blocktemperature</i>
CNTRL \triangle	<i>Block = Temp. mode fast</i> <i>Tube = Temp. mode standard or safe</i> Select the <i>Temp. mode</i> setting based on the reaction volume or the sample properties (see p. 52). The temperature control mode for 0.5 mL standard tubes (not thin-walled) is no longer supported on the Mastercycler nexus.
Block temperature control behavior	Check the <i>Simulate Mastercycler gradient</i> checkbox.

- ▶ Press the *OK* softkey.
 The editor is displayed.
 - ▶ Press the >> softkey. Press the *Save* softkey.
- You can start the program without renewed optimization of the parameters.

8.7 Network connection

You can connect the Mastercycler nexus to an Ethernet network to send e-mails and logs. To set up the network connection, you will need the following information from your network administrator:

- IP address, subnet mask and gateway address for the Mastercycler nexus (specified by the network administrator).
 Alternatively, you can assign the IP address automatically via DHCP.
- IP address of the primary DNS server
 You can optionally enter the IP address of a backup DNS server. Alternatively, you can assign the IP address automatically via DHCP.
- For sending e-mails:
 - E-mail address of the sender, user name and password to log into the SMTP-Server (if required)
 - Name or address and port number of the SMTP server
- For sending Syslog messages:
 - Name or address and port number of the syslog server

8.7.1 Setting up a network connection

Prerequisites

- Ethernet cable (RJ45, Cat.5), not included in the delivery package
- Logged in as an administrator (see p. 37)

Proceed as follows:

1. Select the *System > Network Settings* node.

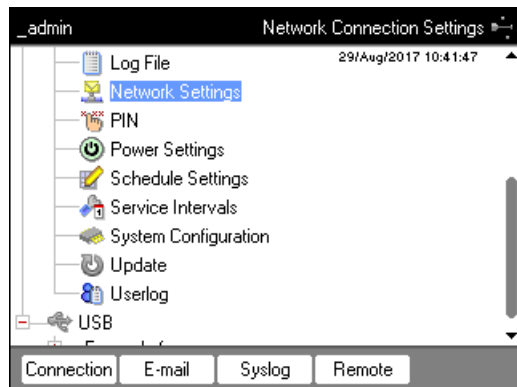

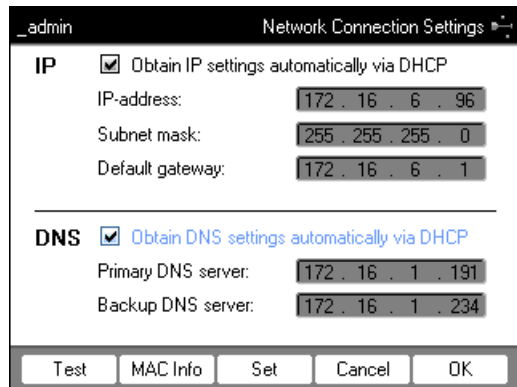

2. Press the *Connection* softkey.

The *Network Connection Settings* window appears.



3. To assign the IP address automatically via DHCP, check the *Obtain IP settings automatically via DHCP* checkbox. Alternatively, enter the IP address, subnet mask and standard gateway as specified by your network administrator.
4. To assign the IP address of the DNS server via DHCP, check the *Obtain DNS settings automatically via DHCP* checkbox. Alternatively, enter the IP addresses of the DNS servers as specified by your network administrator.
5. Insert the Ethernet cable into the Ethernet port on the rear of the device and connect it to an Ethernet port of the Ethernet network.
6. Press the *Set* softkey to accept the settings.

-  Press the *Test* softkey to test the connection to the default gateway.
-  If your network administrator needs the MAC address of the Mastercyclers nexus, press the *MAC Info* softkey.

8.7.2 Setting up e-mail notifications

Prerequisites

- Network connection has been set up (see p. 82)
- Logged in as an administrator (see p. 37)

Proceed as follows:

1. Select the *System > Network Settings* node.

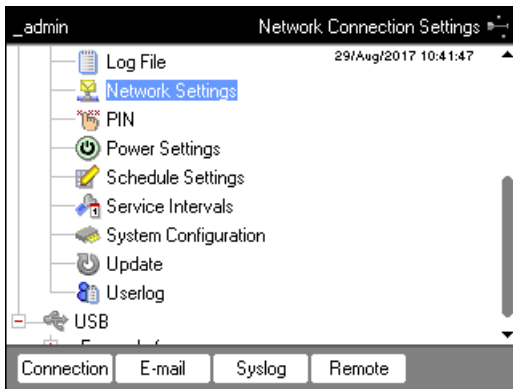

2. Press the *E-mail* softkey.
 The *E-mail Settings* window appears.

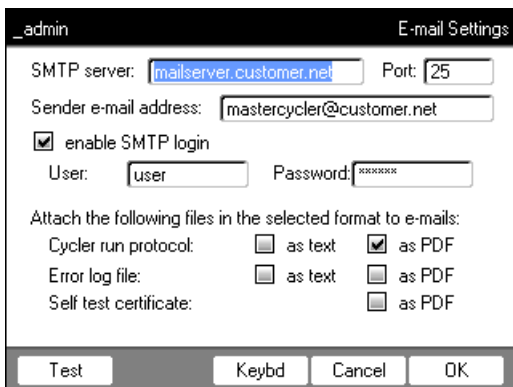

3. Enter the settings as specified by the network administrator.

-  If the SMTP server requires identification, check the *enable SMTP login* checkbox. Enter user name and password.

4. Select the data you would like to send and their file type.
 - *Cycler run protocol*: Protocol of the program run
 - *Error log file*: log with errors that occurred during the program run
 - *Self test certificate*: self test certificate of a successful self test



Press the *Test* softkey to send a test e-mail.

5. Press the *OK* softkey to accept the settings.

8.7.3 Setting up syslog messages

Prerequisites

- Network connection has been set up (see p. 82)
- Logged in as an administrator (see p. 37)

Proceed as follows:

1. Select the *System > Network Settings* node.

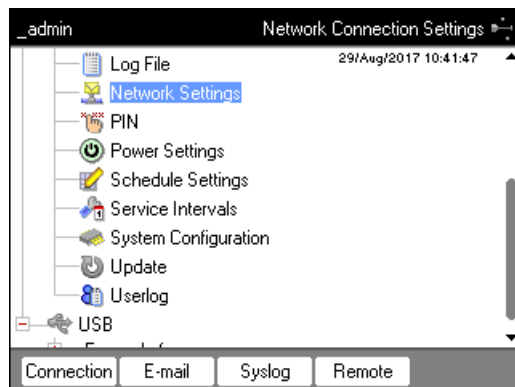

2. Press the *Syslog* softkey.

The *Syslog Settings* window appears.



3. To activate log files on the syslog server, check the *Enable logging to Syslog server* checkbox. Enter the server address and the port.

4. Select the information that you would like to create a protocol for.
 - *Cycler run protocol entries*: Protocol of the program run
 - *Error log file entries*: Errors that occurred during the program run
 - *User log file entries*: log of the user actions (e.g. logging in, logging out, editing programs)



Press the *Test* to send a syslog test message.

5. Press the *OK* softkey to accept the settings.

8.7.4 Activating remote access

Prerequisites

- Network connection has been set up (see p. 82)
- Logged in as an administrator (see p. 37)

The remote access enables you to connect the device to a network via the VisioNize box.

Proceed as follows:



While updating the device software, remote access must be deactivated.

1. Select the *System > Network Settings* node.

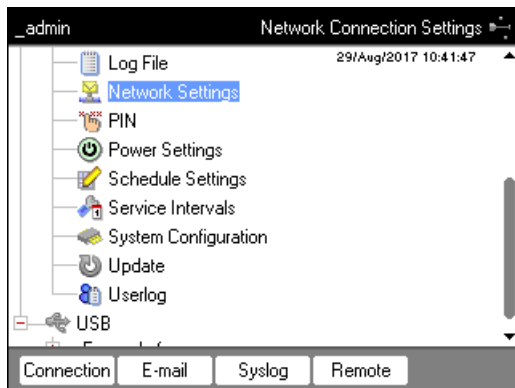

2. Press the *Remote* softkey.

The *Remote Access Setup* window appears.

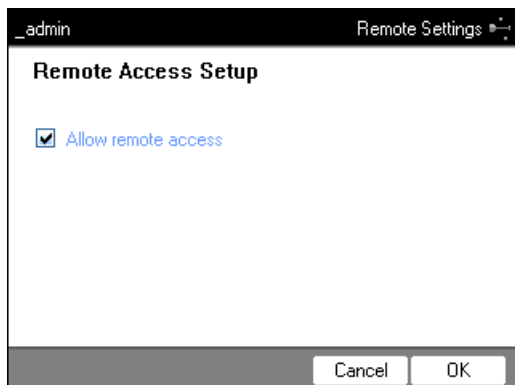

3. Select the *Allow remote access* checkbox.
4. Press the *OK* softkey.

9 Quick start

9.1 Login

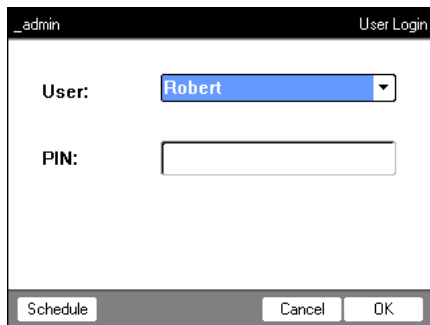

enter

1. Open the list.

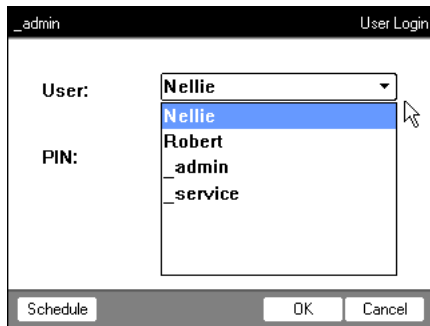

▲

2. Select the user.

▼

enter

3. Confirm your selection.

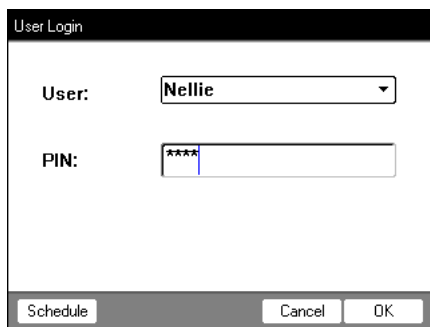

▼

4. Switch to the *PIN*: field.



5. Enter and confirm the PIN.

enter

9.2 Creating folders and programs

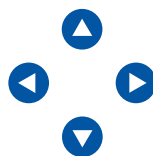
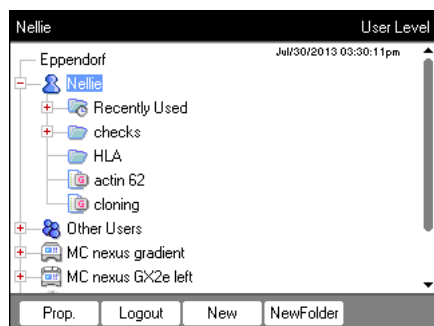

1. Select the user or folder.
2. Press the *New Folder* or *New* softkey.



3. Enter the name and comment and confirm.

9.3 Copying folders and programs

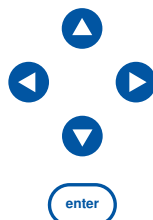
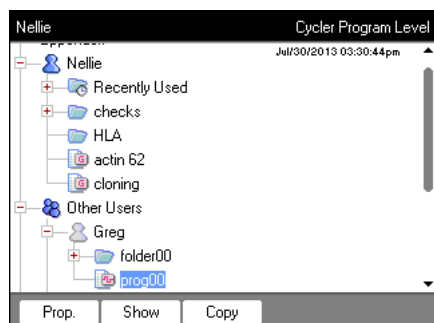

1. Select the folder or program.
2. Press the *Copy* softkey.

3. Confirm the prompt.

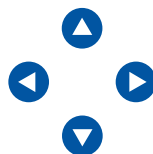
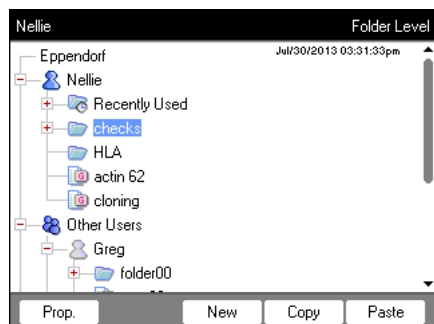

4. Mark the target folder or user.
5. Press the *Paste* softkey.

9.4 Deleting folders and programs

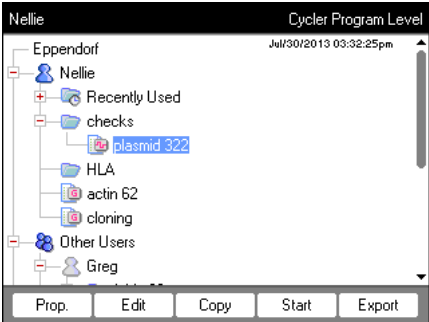

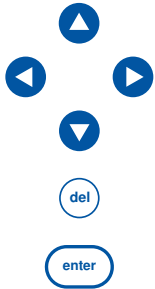

1. Mark the folder or program.
2. Press the **del** key.
3. Press the **enter** key.

9.5 Editing programs

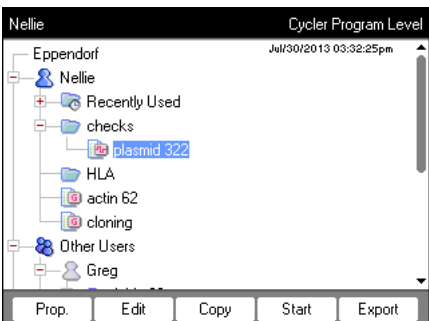

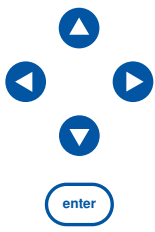

1. Select the program.
2. Open the program editor.



3. Press the *Header* softkey.

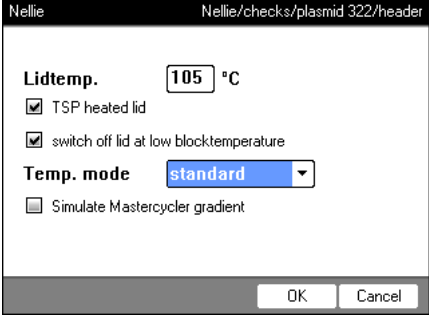

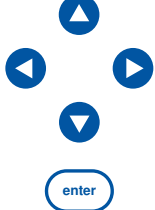

6. Set the temperature control.
7. Confirm your entries.

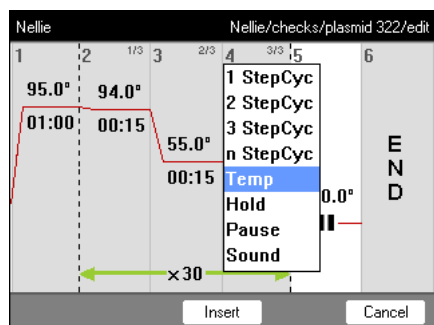

8. Select the program step.
 9. Press the *Insert* softkey.

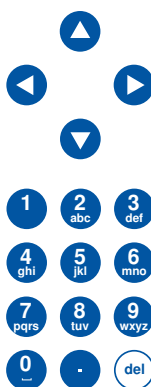
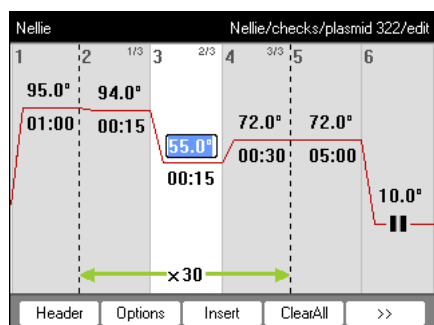

10. Enter the temperatures, holding times and number of cycles.
 11. Select the program step.
 12. Press the *Options* softkey.

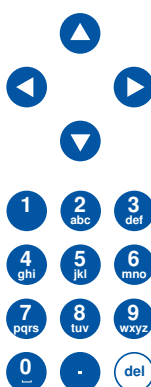
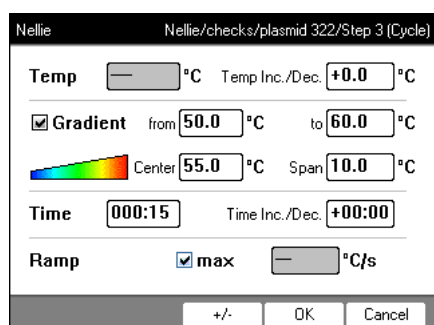

13. Set the gradient, increment and ramp.



14. Confirm your entries.

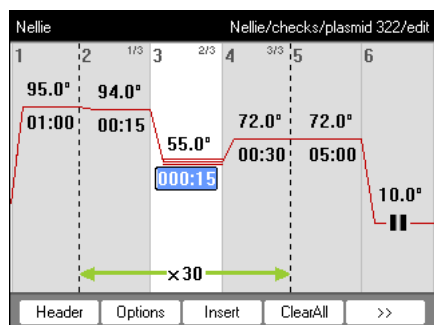

15. Press the >> softkey.
 16. Press the *Save* softkey.
 17. Press the *Exit* softkey.

9.6 Stopping and starting programs

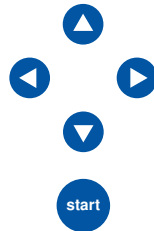
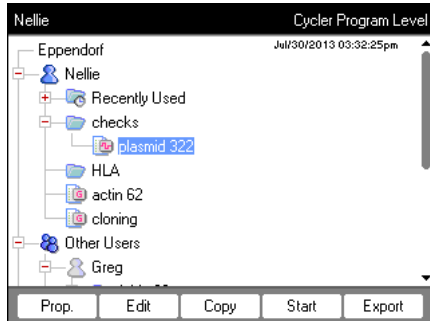

1. Mark the program.

2. Insert the sample tubes.
3. Close the heated lid.
4. Start the program.

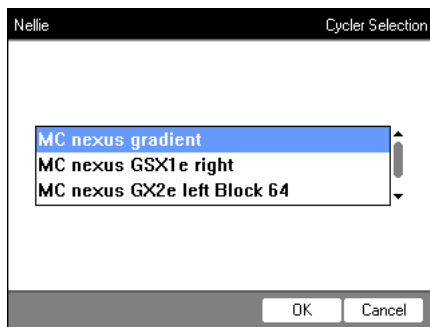

5. If several cyclers are connected:
 highlight the cycler.

6. Confirm input.

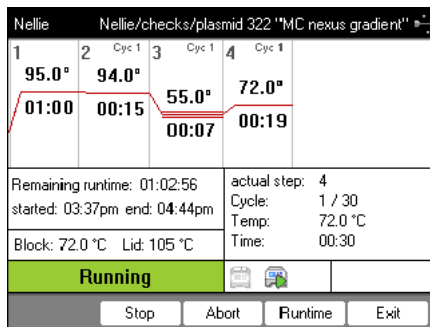

7. The following options are available in the status view:

- Stop the program: press the *Stop* softkey.
- Abort the program: press the *Abort* softkey.
- Resume the program: press the *Resume* softkey.

10 Maintenance

10.1 Cleaning



CAUTION! Risk of burns on the thermoblock, heated lid and reaction vessels.

The thermoblock, heated lid and reaction vessels reach temperatures of over 50 °C very quickly.

- ▶ Wait until the temperature of the thermoblock, heated lid and reaction vessels is below 30 °C.
 - ▶ Then open the heated lid.
-



NOTICE! Damage from the use of aggressive chemicals.

- ▶ Do not use any aggressive chemicals on the device or its accessories, such as strong and weak bases, strong acids, acetone, formaldehyde, halogenated hydrocarbons or phenol.
 - ▶ If the device becomes contaminated with aggressive chemicals, clean it immediately using a mild cleaning agent.
-



DANGER! Electric shock as a result of penetration of liquid.

- ▶ Switch off the device and disconnect the mains/power plug before starting cleaning or disinfection work.
 - ▶ Do not allow any liquids to penetrate the inside of the housing.
 - ▶ Do not spray clean/spray disinfect the housing.
 - ▶ Only plug the device back in if it is completely dry, both inside and outside.
-



DANGER! Electric shock.

- ▶ Switch off the device and disconnect the mains/power plug before starting maintenance or cleaning work.
-

10.1.1 Cleaning the housing

- ▶ Clean the surfaces of the Mastercycler nexus with a damp, lint-free cloth.
- ▶ If necessary, use a neutral lab cleaner.

Instructions on disinfecting and decontaminating the device can be found separately.

10.1.2 Cleaning the heated lid and the thermoblock

1. Open the heated lid.
2. Remove contamination on the thermoblock and the base of the heated lid. Use a damp, lint-free cloth. If necessary, use a neutral lab cleaner.
3. Check to see if there is lettering residue from the tube lids on the heated lid. Remove the residue using ethanol or isopropanol.



Keep the thermoblock bores free of dust and lint. Even small deposits affect the heat transfer between the thermoblock and vessels.

10.2 Disinfection/decontamination



NOTICE! Damage from UV and other high-energy radiation.

- ▶ Do not use UV, beta, gamma, or any other high-energy radiation for disinfecting.
 - ▶ Avoid storage in areas with strong UV radiation
-

Required equipment

- Alcohol (ethanol, isopropanol) or disinfectants containing alcohol

Proceed as follows:

1. Choose the disinfection method which corresponds to the legal regulations and guidelines in place for your range of application.

10.3 Decontamination before shipment

If you are shipping the device to the authorized Technical Service for repairs or to your authorized dealer for disposal please note the following:



WARNING! Risk to health from contaminated device

1. Follow the instructions in the decontamination certificate. You can find it as a PDF file on our website (www.eppendorf.com/decontamination).
 2. Decontaminate all the parts you would like to dispatch.
 3. Include the fully completed decontamination certificate in the packing.
-

11 Troubleshooting

11.1 General errors

Technical faults may be triggered by faults such as a power failure or power fluctuations.

In most cases, the following procedure is therefore sufficient:

1. Switch the device briefly off and back on again after about 10 seconds.
2. Check cable connections.
3. If the fault occurs again: Notify your Eppendorf service team.

12 Transport, storage and disposal

12.1 Packing



CAUTION! Risk of injury when lifting and carrying heavy loads.

The device is heavy. Lifting and carrying the device can lead to back injuries.

- ▶ Only lift and transport the device with a sufficient number of helpers.
 - ▶ Use a transport aid for transporting the device.
-



NOTICE! Damage as a result of incorrect packing.

Eppendorf AG is not liable for damage caused by incorrect packing.

- ▶ The device may only be stored and transported in its original packing.
-



WARNING! Damage to health due to contaminated device and accessories.

- ▶ Decontaminate the device and the accessories before storage and dispatch.
-

Use the supplied packing material when packing the device for transport or storage. If you do not have this anymore or if it is damaged, contact your Eppendorf office.

Prepare the device as follows prior to packing:

1. Pay attention to the decontamination notes (see *Decontamination before shipment on p. 94*).
2. Let the device sit for 30 minutes and make sure there is no condensate in the thermoblock.
3. Load the thermoblock with an empty PCR plate.
4. Close the heated lid.

12.2 Disposal

If the product needs to be disposed of, the relevant legal regulations must be observed.

Information on the disposal of electrical and electronic devices in the European Community:

Within the European Community, the disposal of electrical devices is regulated by national regulations based on EU Directive 2012/19/EU pertaining to waste electrical and electronic equipment (WEEE).

According to these regulations, any devices supplied after August 13, 2005, in the business-to-business sphere, to which this product is assigned, may no longer be disposed of in municipal or domestic waste. To document this, they have been marked with the following marking:



Because disposal regulations may differ from one country to another within the EU, please contact your supplier if necessary.

13 Technical data

13.1 Power supply

Voltage	100 V – 130 V, ± 10 % 200 V – 240 V, ± 10 %
Frequency	50 Hz – 60 Hz
Power consumption (devices with aluminum thermoblock)	max. 700 W
Power consumption (devices with silver thermoblock)	max. 540 W
Overvoltage category	II (IEC 61010-1)
Degree of pollution	2
Protection class	1

13.2 Weight/dimensions

Dimensions	Width: 25.0 cm (9.8 inch) Depth: 41.0 cm (16.1 inch) Height: 32.0 cm (12.6 inch) Height with heated lid open: 44.5 cm (17.5 inch)
Dimensions (devices with a thermoblock with 64+32 wells)	Width: 25.0 cm (9.8 inch) Depth: 41.0 cm (16.1 inch) Height: 33.0 cm (13.0 inch) Height with heated lid open: 44.5 cm (17.5 inch)
Weight (Master variant)	11.0 kg (24.3 lb)
Weight (eco variant)	10.5 kg (23.2 lb)

13.3 Ambient conditions

General operation	15 °C – 35 °C up to 70 % relative humidity up to 2 000 m NN (approx. 80 kPa)
Storage	–20 °C – 70 °C up to 85 % relative humidity

13.4 Application parameters

Mastercycler nexus gradient, Mastercycler nexus gradient eco	
Thermoblock	Universal block, aluminum
Sample capacity	<ul style="list-style-type: none"> • 96 × 0.1 mL PCR tubes • 96 × 0.2 mL PCR tubes • 71 × 0.5 mL PCR tubes • one 96-well PCR plate (unskirted, semi-skirted, skirted; standard and low-profile)
Thermoblock temperature control range	4 °C - 99 °C
Ramp rate (measured on the thermoblock)	max. 3°C/s
Thermoblock temperature homogeneity (with the gradient function switched off) at 35°C at 90°C	≤ 0.3 °C ≤ 0.4 °C
Control accuracy (with the gradient function switched off)	±0.2°C
Gradient range	max. 20°C
Gradient temperature control range	30 °C - 99 °C
Heated lid temperature control range	37 °C - 110 °C
Mastercycler nexus, Mastercycler nexus eco	
Thermoblock	Universal block, aluminum
Sample capacity	<ul style="list-style-type: none"> • 96 × 1 mL PCR tubes • 96 × 2 mL PCR tubes • 71 × 0.5 mL PCR tubes • one 96-well PCR plate (unskirted, semi-skirted, skirted; standard and low-profile)
Thermoblock temperature control range	4 °C - 99 °C
Ramp rate (measured on the thermoblock)	max. 3°C/s
Thermoblock temperature homogeneity at 35°C at 90°C	≤ 0.3 °C ≤ 0.4 °C
Control accuracy	±0.2°C
Gradient range	–
Gradient temperature control range	–
Heated lid temperature control range	37 °C - 110 °C

Mastercycler nexus GSX1, Mastercycler nexus GSX1e

Thermoblock	Universal block, silver
Sample capacity	<ul style="list-style-type: none"> • 96 × 1 mL PCR tubes • 96 × 2 mL PCR tubes • one 96-well PCR plate (unskirted, semi-skirted, skirted; standard and low-profile)
Thermoblock temperature control range	4 °C - 99 °C
Ramp rate (measured on the thermoblock)	max. 5°C/s
Thermoblock temperature homogeneity (with the gradient function switched off)	
at 35°C	≤ 0.3 °C
at 90°C	≤ 0.4 °C
Control accuracy (with the gradient function switched off)	±0.2°C
Gradient range	max. 20°C
Gradient temperature control range	30 °C - 99 °C
Heated lid temperature control range	37 °C - 110 °C

Mastercycler nexus SX1, Mastercycler nexus SX1e

Thermoblock	Universal block, silver
Sample capacity	<ul style="list-style-type: none"> • 96 × 1 mL PCR tubes • 96 × 2 mL PCR tubes • one 96-well PCR plate (unskirted, semi-skirted, skirted; standard and low-profile)
Thermoblock temperature control range	4 °C - 99 °C
Ramp rate (measured on the thermoblock)	max. 5°C/s
Thermoblock temperature homogeneity	
at 35°C	≤ 0.3 °C
at 90°C	≤ 0.4 °C
Control accuracy	±0.2°C
Gradient range	–
Gradient temperature control range	–
Heated lid temperature control range	37 °C - 110 °C

Technical data
 Mastercycler® nexus
 English (EN)

Mastercycler nexus flat, Mastercycler nexus flat eco	
Thermoblock	Flat block, aluminum
Sample capacity	4 slides
Thermoblock temperature control range	4 °C - 99 °C
Ramp rate (measured on the thermoblock)	max. 3°C/s
Thermoblock temperature homogeneity (with the gradient function switched off) at 35°C at 90°C	≤ 0.3 °C ≤ 0.4 °C
Control accuracy (with the gradient function switched off)	±0.2°C
Gradient range	max. 20°C
Gradient temperature control range	30 °C - 99 °C
Heated lid temperature control range	37 °C - 110 °C

Mastercycler nexus GX2, Mastercycler nexus GX2e	
Thermoblock	Universal block, aluminum
Sample capacity	<ul style="list-style-type: none"> • 96 × 1 mL PCR tubes • 96 × 2 mL PCR tubes • 64 × 0.5 mL PCR tubes • one 64-well PCR plate (unskirted, semi-skirted, skirted; standard and low-profile) • one 32-well PCR plate (unskirted, semi-skirted, skirted; standard and low-profile)
Thermoblock temperature control range	4 °C - 99 °C
Ramp rate (measured on the thermoblock)	max. 3°C/s
Thermoblock temperature homogeneity (with the gradient function switched off)	
at 35°C	≤ 0.3 °C
at 90°C	≤ 0.4 °C
Control accuracy (with the gradient function switched off)	±0.2°C
Thermoblock with 64 wells	
Gradient range	max. 12°C
Gradient temperature control range	30 °C - 99 °C
Heated lid temperature control range	37 °C - 110 °C
Thermoblock with 32 wells	
Gradient range	–
Gradient temperature control range	–
Heated lid temperature control range	37 °C - 110 °C

Mastercycler nexus X2, Mastercycler nexus X2e	
Thermoblock	Universal block, aluminum
Sample capacity	<ul style="list-style-type: none"> • 96 × 1 mL PCR tubes • 96 × 2 mL PCR tubes • 64 × 0.5 mL PCR tubes • one 64-well PCR plate (unskirted, semi-skirted, skirted; standard and low-profile) • one 32-well PCR plate (unskirted, semi-skirted, skirted; standard and low-profile)
Thermoblock temperature control range	4 °C - 99 °C
Ramp rate (measured on the thermoblock)	max. 3°C/s
Thermoblock temperature homogeneity at 35°C at 90°C	≤ 0.3 °C ≤ 0.4 °C
Control accuracy	±0.2°C
Gradient range	–
Gradient temperature control range	–
Heated lid temperature control range	37 °C - 110 °C

14 Ordering information

14.1 Mastercycler nexus

14.1.1 Master variants

Order no. (International)	Order no. (North America)	Description
6331 000.017	6331000025	Mastercycler nexus gradient 230 V/50 – 60 Hz 110 V/50 – 60 Hz (US)
6333 000.014	6333000022	Mastercycler nexus 230 V/50 – 60 Hz 110 V/50 – 60 Hz (US)
6345 000.010	6345000028	Mastercycler nexus GSX1 230 V/50 – 60 Hz 110 V/50 – 60 Hz
6346 000.013	6346000021	Mastercycler nexus SX1 230 V/50 – 60 Hz 110 V/50 – 60 Hz
6335 000.011	6335000020	Mastercycler nexus flat 230 V/50 – 60 Hz 110 V/50 – 60 Hz (US)
6336 000.015	6336000023	Mastercycler nexus GX2 230 V/50 – 60 Hz 110 V/50 – 60 Hz
6337 000.019	6337000027	Mastercycler nexus X2 230 V/50 – 60 Hz 110 V/50 – 60 Hz

14.1.2 Eco variants

Order no. (International)	Order no. (North America)	Description
6334 000.018	6334000026	Mastercycler nexus gradient eco 230 V/50 – 60 Hz 110 V/50 – 60 Hz
6332 000.010	6332000029	Mastercycler nexus eco 230 V/50 – 60 Hz 110 V/50 – 60 Hz (US)
6347 000.017	6347000025	Mastercycler nexus GSX1e 230 V/50 – 60 Hz 110 V/50 – 60 Hz
6348 000.010	6348000029	Mastercycler nexus SX1e 230 V/50 – 60 Hz 110 V/50 – 60 Hz
6330 000.013	6330000021	Mastercycler nexus flat eco 230 V/50 – 60 Hz 110 V/50 – 60 Hz
6338 000.012	6338000020	Mastercycler nexus GX2e 230 V/50 – 60 Hz 110 V/50 – 60 Hz
6339 000.016	6339000024	Mastercycler nexus X2e 230 V/50 – 60 Hz 110 V/50 – 60 Hz

14.2 Accessories



Use only original Eppendorf accessories or accessories approved by Eppendorf.

Order no. (International)	Order no. (North America)	Description
5341 612.006 5341 611.000	950014008 950014016	CAN bus connecting cable 50 cm 150 cm
0056 000.003	0056000003	Temperature Verification System – USB – Single Channel Measuring device without temperature sensor
0056 001.000 0056 001.506	0056001000 0056001506	Temperature sensor for 96 Well ISO 9001 ISO 17025

14.3 Consumables

Order no. (International)	Order no. (North America)	Description
0030 128.648	951020401	Eppendorf twin.tec PCR Plate 96 skirted, 150 µL PCR clean, colorless, 25 pcs.
0030 128.575	951020303	Eppendorf twin.tec PCR Plate 96 semi-skirted, 250 µL PCR clean, colorless, 25 pcs.
0030 133.307	0030133307	Eppendorf twin.tec PCR Plate 96, low profile unskirted, 150 µL PCR clean, colorless, 20 pcs.
0030 133.358	0030133358	Eppendorf twin.tec PCR Plate 96, divisible unskirted, 150 µL PCR clean, colorless, 20 pcs.
0030 133.366	0030133366	Eppendorf twin.tec PCR Plate 96 unskirted, 250 µL PCR clean, colorless, 20 pcs.
0030 133.374	0030133374	Eppendorf twin.tec PCR Plate 96, divisible unskirted, 250 µL PCR clean, colorless, 20 pcs.
0030 129.300	0030129300	Eppendorf twin.tec microbiology PCR plate 96 skirted, 150 µL PCR clean, colorless, 10 pcs.
0030 129.326	0030129326	Eppendorf twin.tec microbiology PCR plate 96 semi-skirted, 250 µL PCR clean, colorless, 10 pcs.
0030 129.504	0030129504	Eppendorf twin.tec PCR Plates 96 LoBind, semi-skirted PCR clean, colorless, 25 pcs.
0030 129.512	0030129512	Eppendorf twin.tec PCR Plates 96 LoBind, skirted PCR clean, colorless, 25 pcs.
0030 124.537	0030124537	Eppendorf PCR Tubes 0.5 mL PCR clean, with hinged lid, clear, 500 pcs.
0030 124.332 0030 124.359	951010006 951010022	Eppendorf PCR Tubes 0.2 mL PCR clean, colorless, 1000 pcs. PCR clean, 8-tube strips, 120 pcs. (960 tubes)
0030 124.804 0030 124.812 0030 124.820	0030124804 0030124812 0030124820	Eppendorf PCR Tube Strips 0.1 mL without lids (10 × 12 strips) PCR clean, with Cap Strips, domed (10 × 12 strips) PCR clean, with Cap Strips, flat (10 × 12 strips)
0030 124.839 0030 124.847	0030124839 0030124847	Cap Strips 8-strips domed, 120 pcs. (10 × 12 pcs.) flat, 120 pcs. (10 × 12 pcs.)
0030 127.838	0030127838	Eppendorf Heat Sealing Film PCR clean, 100 pcs.

Ordering information

Mastercycler® nexus
English (EN)

Order no. (International)	Order no. (North America)	Description
0030 127.854	0030127854	Eppendorf Heat Sealing Foil PCR clean, 100 pcs.
0030 127.781	0030127781	Eppendorf PCR Film self-adhesive PCR clean, 100 pcs.
0030 127.790	0030127790	Eppendorf PCR Foil self-adhesive PCR clean, 100 pcs.

The twin.tec PCR plates are also available in various frame colors (red, yellow, green, blue). The complete range of PCR consumables can be found in the Eppendorf catalog or at www.eppendorf.com.

14.4 Recommended auxiliary materials

Order no. (International)	Order no. (North America)	Description
0030 124.545	0030124545	PCR Rack 10 pcs.
0030 124.235	951010031	Work tray for semi-/unskirted PCR plates, PCR strips and 0.2 mL PCR tubes, for Rotor A-2-VC set of 10 pcs.
0030 124.243	951010049	Frame for work tray for Rotor A-2-VC set of 5 pcs.
3881 000.023 3881 000.031	022510541 022510525	PCR-Cooler 0.2 mL Pink Blue
5391 000.001	5391000001	HeatSealer S100 100 – 230 V/50 – 60 Hz
5392 000.005	5392000005	HeatSealer S200 100 – 230 V/50 – 60 Hz

Index

1

1 ... 3 StepCyc (program step)53

A

Access rights69

Adjustment76

Administrator functions.....69

Alarm

 Activate72

 Deactivate72

Attach (devices)29

Auto-Restart76

B

Backup.....78

Block type.....76

C

CAN connection31

Change country settings.....72

Cleaning

 Heated lid.....94

 Housing.....93

 Thermoblock94

Connecting the mouse.....30

Connecting the printer30

Country Settings.....72

D

Decontamination..... 94

Defining the administrator PIN 35

Devices

 Attach 29

 Separate..... 30

Disinfection..... 94

Disposal 98

E

E-mail address 81

E-mail notification 36, 81

Eco device

 connect..... 31

Export 79

 Program..... 57

F

fast (header setting)..... 52

Folder

 Change comment 42

 Change name..... 42

 Copy 44

 Create new..... 42

 Delete 44

 Import..... 79

G

Gradient 50, 55

H

Heated lid

 Close..... 34

 Open 33

 Switch lid heater off automatically..... 52

 Temperature control prior to program start.... 52

Hold (program step) 54

Holding time increment..... 50

Index

Mastercycler® nexus
English (EN)

I

IP address81

L

Log file

 Display72

 Export.....72

Login37

Logout38

N

Navigation tree39

n StepCyc (program step).....53

P

Pause (program step)54

PDF.....41

PIN

 Activate72

 Administrator35

 Change71

 Deactivate72

 Define.....35

Power save mode72

Program

 Change comment43

 Continue.....66

 Copy44

 Create new43

 Delete44

 Edit header.....51

 Export.....57, 79

 Import79

 Interrupt.....66

 Rename43

 Restore78

 Save.....78

 Start.....63

 Stop66

 Transfer79

 Write protection.....43

Program editor

 Create gradient step 55

 Description 50

 Editing parameters 54

 Exit 58

 Extended options..... 54

 Header 51

 Insert step..... 53

 Open 49

 Saving a program 58

 Set gradient 55

 Set holding time increment..... 55

 Set temperature control speed 55

 Set temperature increment 55

Program header

 Heated lid 52

 Set lid temperature..... 52

 Simulate Mastercycler gradient 52

 Switch off lid at low block temperature 52

 Temp. mode..... 52

Program template

 Template..... 59

R

Restart..... 76

Restore..... 78

S

safe (header setting) 52

Sample tubes

 Insert 62

 Select..... 61

Sample volume 62

Schedule 73

 Display..... 46

 Edit 45

 Use 44

Selecting a location 27

Self-test..... 77

Service intervals 73

Set date 72

Set time 72

Simulate Mastercycler 5333/5331	52	U	
Sound (program step)	54	USB	
Space requirements.....	27	Connections	30
standard (header setting)	52	User account	
Standby.....	46	Access rights	69
Status view	64	Create	69
Status view, common	65	Delete	70
Storage medium		Edit.....	70
Connect.....	40	User log	
Labware	41	Delete	74
Use	40	Display.....	74
Switch		Export.....	74
Eco (right/left).....	32	Users	
Term (off/on)	32	Change	38
Switch lid heater off automatically.....	52	Guest	38
System configuration	74	Login	37
System settings	72	Logout	38
		V	
T		Verification	76
Temp (program step).....	53		
Temp. mode.....	52		
Temperature control speed	50, 55		
Temperature increment.....	50, 55		
Text file format	41		
Thermoblock			
Adjust.....	77		
Load	61		
Sample volume.....	62		
Self-test	77		
Verification.....	77		
Time increment	55		
TSP			
Switching off.....	52		
Switching on	52		
TXT.....	41		

Declaration of Conformity

The product named below fulfills the requirements of directives and standards listed. In the case of unauthorized modifications to the product or an unintended use this declaration becomes invalid.

Product name:

Mastercycler® nexus, Mastercycler® nexus X2, Mastercycler® nexus X2e
Mastercycler® nexus flat, Mastercycler® nexus eco, Mastercycler® nexus flat eco,
Mastercycler® nexus gradient, Mastercycler® nexus gradient eco,
Mastercycler® nexus GSX1, Mastercycler® nexus GSX1e,
Mastercycler® nexus GX2, Mastercycler® nexus GX2e,
Mastercycler® nexus SX1, Mastercycler® nexus SX1e

Product type:

Thermocycler

Relevant directives / standards:

2014/35/EU: EN 61010-1, EN 61010-2-010
UL 61010A-1, CSA C22.2 No. 61010-1
2014/30/EU: EN 55011, EN 61326-1
2011/65/EU: EN 50581

Date: March 10, 2016



Management Board



Portfolio Management

Your local distributor: www.eppendorf.com/contact
Eppendorf AG · 22331 Hamburg · Germany
eppendorf@eppendorf.com

Eppendorf® and the Eppendorf logo are registered trademarks of Eppendorf AG, Germany.
U.S. Design Patents are listed on www.eppendorf.com/ip.
All rights reserved, incl. graphics and pictures. Copyright 2015 © by Eppendorf AG.

www.eppendorf.com

ISO 9001
Certified

ISO
13485
Certified

ISO
14001
Certified

Measurement of sound power level according to
DIN EN ISO 3744: 2011-02 / EN ISO 3744:2010

PCR-Cycler

Eppendorf AG, 22331 Hamburg, Germany

1. **Machine:**

- | | | |
|-----|-----------------------|-------------------|
| 1.1 | Type: | Eppendorf MCnexus |
| 1.2 | Serial Number: | FT-6331-28 |
| 1.3 | Year of construction: | 2011 |

2. **Specifications:**

See documents of the manufacturer

3. **Measurement system:**

- | | | |
|-----|-------------------------------|--------------|
| 3.1 | Calibrated sound level meter: | Norsonic 118 |
|-----|-------------------------------|--------------|

4. **Measurement surface:**

- | | | |
|-----|-----------------------|-------------------------------------|
| 4.1 | Measurement surface: | hemisphere with 10 measuring points |
| 4.2 | Measurement distance: | 1 m |

5. **Measurement conditions:**

- | | | |
|-----|-------------------------------------|------------------------------------|
| 5.1 | Environment: | Free field over a reflecting plane |
| 5.2 | Environmental correction K_{2A} : | 0.7 dB(A) |
| 5.3 | accuracy class | 2 |
| 5.4 | Operating conditions: | PCR cyclus |

- | | | |
|----|---|------------|
| 6. | <u>Measurement surface sound pressure level:</u> | 31.2 dB(A) |
| | <u>Sound power level:</u> | 39.2 dB(A) |

TÜV Nord Umweltschutz GmbH & Co. KG

Große Bahnstraße 31, 22525 Hamburg

Nr. 111UBS165 Date of measurement: 22.10.2011

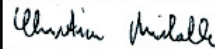

Dipl. - Ing. C. Michalke

Evaluate Your Manual

Give us your feedback.

www.eppendorf.com/manualfeedback

Your local distributor: www.eppendorf.com/contact

Eppendorf AG · Barkhausenweg 1 · 22339 Hamburg · Germany
eppendorf@eppendorf.com · www.eppendorf.com