

Register your instrument!
www.eppendorf.com/myeppendorf



Centrifuge 5804/5804 R/5810/5810 R

Operating manual

© 2014 Eppendorf AG

All rights reserved, including graphics and images. No part of this publication may be reproduced without the prior permission of the copyright owner.

Eppendorf® and the Eppendorf logo are registered trademarks of Eppendorf AG, Hamburg, Germany.

CombiSlide is a registered trademarks of Eppendorf AG, Hamburg, Germany.

Centriplus is a registered trademark of Millipore Corporation, Billerica, USA.

Corning is a registered trademark of Corning Inc., Corning, NY, USA.

Microtainer is a registered trademark of Becton Dickinson, Franklin Lakes, NJ, USA.

Registered trademarks and protected trademarks are not marked in all cases with ® or ™ in this manual.

Table of contents

1	Operating instructions	7
1.1	Using this manual	7
1.2	Danger symbols and danger levels	7
1.2.1	Danger symbols	7
1.2.2	Danger levels	7
1.3	Symbols used	7
1.4	Abbreviations used	8
2	Product description	9
2.1	Main illustration	9
2.2	Delivery package	9
2.3	Features	10
2.4	Rotors	11
2.4.1	Rotor A-4-81 (only 5810/5810 R)	11
2.4.2	Rotor A-4-62 and A-4-62-MTP (only 5810/5810 R)	16
2.4.3	Rotor A-4-44	20
2.4.4	Rotor A-2-DWP-AT (only 5810/5810 R)	23
2.4.5	A-2-DWP rotor	24
2.4.6	Rotor FA-45-6-30	26
2.4.7	Rotor F-34-6-38	28
2.4.8	Rotor FA-45-30-11 and F-45-30-11	30
2.4.9	Rotor F-45-48-PCR	31
2.4.10	Rotor T-60-11	31
2.4.11	Rotor S-4-104 (only 5810/5810 R)	32
2.4.12	Rotor S-4-72	37
2.4.13	Rotor F-35-48-17	39
2.4.14	Rotor FA-45-48-11	40
2.4.15	Rotor FA-45-20-17	41
3	Safety	43
3.1	Intended use	43
3.2	User profile	43
3.3	Application limits	43
3.3.1	Declaration concerning the ATEX directive (94/9/EC)	43
3.3.2	Maximum service life for accessories	44
3.4	Information on product liability	45
3.5	Warnings for intended use	46
3.5.1	Personal injury or damage to the equipment	46
3.5.2	Incorrect handling of the centrifuge	48
3.5.3	Incorrect handling of the rotors	48
3.5.4	Extreme strain on the centrifuging tubes	49
3.5.5	Aerosol-tight centrifugation	50
3.6	Safety instructions located on the device	51
4	Installation	53
4.1	Selecting the location	53
4.2	Preparing installation	53
4.3	Installing the instrument	54

Table of contents

Centrifuge 5804/5804 R/5810/5810 R
English (EN)

5	Operation	57
5.1	Overview of operating controls	57
5.2	Preparing for centrifugation	58
5.2.1	Switching on the centrifuge	58
5.2.2	Inserting the rotor	58
5.2.3	Automatic rotor detection	58
5.2.4	Loading the rotor	59
5.2.5	Closing the centrifuge lid	63
5.3	Cooling (only 5804 R/5810 R)	64
5.3.1	Temperature adjustment	64
5.3.2	Temperature display	64
5.3.3	Temperature monitoring	64
5.3.4	FastTemp	64
5.3.5	Continuous cooling	65
5.4	Centrifuging	66
5.4.1	Centrifugation with time setting	66
5.4.2	Centrifuging in continuous operation	67
5.4.3	Short spin centrifugation	68
5.4.4	Removing the rotor	68
5.4.5	Standby mode	69
6	Operating controls and function	71
6.1	Setting the radius	71
6.2	Setting the acceleration and braking times	71
6.3	Setting the start of run time (At set rpm)	71
6.4	Saving the program	72
6.5	Loading the program	72
6.6	Deleting the program	73
6.7	Special functions	73
6.7.1	Display operating hours	73
6.7.2	Switching on/off the warning signal	73
6.7.3	Exiting the service functions	73
6.7.4	Controlling the centrifuge via the serial interface (optional)	73
7	Maintenance	75
7.1	Maintenance	75
7.2	Prepare cleaning/disinfection	75
7.3	Cleaning/disinfection	76
7.3.1	Cleaning and disinfecting the device	77
7.3.2	Cleaning and disinfecting the rotor	77
7.4	Additional care instructions for refrigerated centrifuges	78
7.5	Glass breakage	79
7.6	Decontamination before shipment	79
8	Troubleshooting	81
8.1	Resetting the excess current switch	81
8.2	General errors	81
8.3	Error messages	82
8.4	Emergency release	84

9	Transport, storage and disposal	85
9.1	Transport	85
9.2	Storage	85
9.3	Disposal	85
10	Technical data	87
10.1	Power supply	87
10.2	Ambient conditions	87
10.3	Weight/dimensions	88
10.4	Application parameters	89
11	Ordering information	91
11.1	Centrifuge 5804/5804 R	91
11.2	Centrifuge 5810/5810 R	91
11.3	Rotors and accessories	91
11.3.1	Rotor A-4-81 (only 5810/5810 R)	91
11.3.2	Rotor A-4-62 and A-4-62-MTP (only 5810/5810 R)	94
11.3.3	Rotor A-4-44	95
11.3.4	Rotor A-2-DWP-AT (only 5810/5810 R)	96
11.3.5	A-2-DWP rotor	97
11.3.6	Rotor FA-45-6-30	97
11.3.7	Rotor F-34-6-38	98
11.3.8	Rotor FA-45-30-11 and rotor F-45-30-11	99
11.3.9	Rotor F-45-48-PCR	99
11.3.10	Rotor T-60-11	99
11.3.11	Rotor S-4-104	100
11.3.12	Rotor S-4-72	101
11.3.13	Rotor F-35-48-17	102
11.3.14	Rotor FA-45-48-11	102
11.3.15	Rotor FA-45-20-17	103
11.3.16	Miscellaneous	103
12	Annex Short instructions	105
	Certificates	107

Table of contents

Centrifuge 5804/5804 R/5810/5810 R
English (EN)

1 Operating instructions







1.1 Using this manual

- ▶ Read this operating manual completely before using the device for the first time. Also observe the instructions for use of the accessories.
- ▶ This operating manual is part of the product. Thus, it must always be easily accessible.
- ▶ Enclose this operating manual when transferring the device to third parties.
- ▶ You will find the current version of the operating manual for all available languages on our webpage under www.eppendorf.com.

1.2 Danger symbols and danger levels

The safety instructions of this operating manual indicate the following danger symbols and danger levels:


1.2.1 Danger symbols

	Biohazard		Explosion
	Electric shock		Crushing
	Hazard point		Material damage

1.2.2 Danger levels

DANGER	<i>Will lead to severe injuries or death.</i>
WARNING	<i>May lead to severe injuries or death.</i>
CAUTION	<i>May lead to light to moderate injuries.</i>
NOTICE	<i>May lead to material damage.</i>

1.3 Symbols used

Depiction	Meaning
1.	Actions in the specified order
2.	
▶	Actions without a specified order
•	List
<i>Text</i>	Display text or software text
	Additional information

Operating instructions

Centrifuge 5804/5804 R/5810/5810 R
English (EN)

1.4 Abbreviations used

MTP

Microplate

NN

Mean sea level (MSL)

PCR

Polymerase chain reaction

PTFE

Polytetrafluorethylene

RZB/rcf

Relative centrifugal force – *g*-force in m/s^2

rpm

Revolutions per minute – in rpm

UV

Ultraviolet radiation

2 Product description

2.1 Main illustration



Fig. 2-1: Depiction of Centrifuge 5810 and Centrifuge 5810 R. The Centrifuge 5804 and Centrifuge 5804 R are similar in design.

1 Centrifuge lid

2 Monitoring glass

Visual control for rotor stop or option for speed check via stroboscope

3 Operator panel with display

(see *Overview of operating controls* on p. 57)

4 Emergency release

(see *Emergency release* on p. 84)

5 Condensation water tray (only Centrifuge 5804 R/5810 R)

2.2 Delivery package

Each delivery package consists of one of the following centrifuges and the accessories listed in the following.

Quantity	Order no. (International)	Order no. (North America)	Description
1	–	–	5804/5804 R/5810/5810 R centrifuge See chapter <i>Ordering Information</i> for corresponding device version, equipment and order number
1	5810 350.018	022664166	Rotor key Standard
1	–	–	Mains/power cord see chapter <i>Ordering information</i> for corresponding power cable variants and order numbers

Product description

Centrifuge 5804/5804 R/5810/5810 R
English (EN)

Quantity	Order no. (International)	Order no. (North America)	Description
1	5820 900.040	5820900040	Operating manual Centrifuge 5804/5804 R/5810/5810 R Languages: EN, DE, FR, ES, IT, PT
1	5820 900.059	5820900059	Languages: DA, EL, FI, NL, SV (230 V devices only)

Only 5804 R and 5810 R:

Quantity	Order no. (International)	Order no. (North America)	Description
1	5811 001.068	022662678	Tray for condensation water

2.3 Features

The versatile 5804/5804 R/5810/5810 R centrifuge has a capacity of maximally 4 x 250 mL (5804/5804 R centrifuge) resp. 4 x 750 mL (5810/5810 R centrifuge) and achieves max. 20,800 x g/14,000 rpm. The versatility is reflected in the available rotor options. You can select between 12 (5804/5804 R centrifuge) resp. 16 (5810/5810 R centrifuge) different rotors to centrifuge the following tubes for your various applications:

- Micro test tubes (0.2 to 5.0 ml)
- PCR strips
- Microtainers
- Spin columns
- Cryotubes
- Conical tubes (15/50 mL)
- Bottles (175 to 750 mL)
- Various tubes (3 to 120 mL)
- Microplates
- PCR plates
- Deepwell plates (max. height 29 mm)
- Slides (with CombiSlide adapter)
- Cell culture tubes

Handling the centrifuge is facilitated by:

- Low access height of 29 cm for loading and unloading the rotors
- Automatic rotor detection with rotational speed limit
- Automatic rotor imbalance detection
- Clear digital display

All centrifuges in these series have 35 program spaces for user-defined settings and 10 different acceleration and braking ramps.

Adapter-specific manual radius adjustment guarantees maximum RCF accuracy.

The Centrifuge 5804 R/5810 R has an additional temperature control function for centrifugation between -9°C and 40°C. Use the **FastTemp** function to start a temperature control run without samples to adjust the rotor chamber incl. rotor, buckets and adapters quickly to the set target temperature. Continuous cooling also maintains the temperature in the rotor chamber with the centrifuge lid closed when the centrifuge is not in use.

The built-in condensation drain eliminates water accumulation and prevents corrosion.

2.4 Rotors



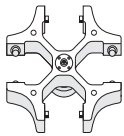


Eppendorf centrifuges may only be operated with rotors that are intended for use with the corresponding centrifuge.


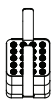

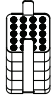


- ▶ Only use rotors which bear the name of the centrifuge (e.g. 5804 R).

This 5804/5804 R/5810/5810 R centrifuge can be operated with the following rotors. Before using sample tubes, please note the recommended manufacturer's specifications with regard to the resistance to centrifugation (max. g-force).


















2.4.1 Rotor A-4-81 (only 5810/5810 R)




2.4.1.1 Rotor A-4-81 with 500 mL rectangular bucket

			Max. g-force: 3,220 × g
Rotor A-4-81	Rectangular bucket 500 mL	Aerosol-tight cap	Max. speed: 4,000 rpm
Swing-bucket rotor with 4 × 500 mL rectangular buckets			Max. load per bucket (adapter, tube and contents): 780 g

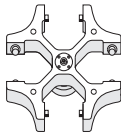

Vessel	Vessel Capacity Vessels per adapter/rotor	Adapters Order no. (international)	Adapter bottom shape Tube diameter Max. tube length with/without aerosol-tight bucket cap	Max. g-force Max. speed Centrifugation radius
	Vessel 1.5/2 mL 20/80	 5810 745.004	flat Ø 11 mm 43 mm/43 mm	2,950 × g 4,000 rpm 16.5 cm
	Blood collection tube 1.2 to 5 mL 20/80	 5810 746.000	flat Ø 11 mm 108 mm/108 mm	3,000 × g 4,000 rpm 16.8 cm
	Vessel 2.6 to 5 mL 25/100	 5810 720.001	flat Ø 13 mm 107 mm/108 mm	3,000 × g 4,000 rpm 16.8 cm




Product descriptionCentrifuge 5804/5804 R/5810/5810 R
English (EN)

Vessel	Vessel Capacity Vessels per adapter/rotor	Adapters Order no. (international)	Adapter bottom shape Tube diameter Max. tube length with/without aerosol-tight bucket cap	Max. g-force Max. speed Centrifugation radius
	Vessel 2.6 to 7 mL 18/72	 5810 747.007	flat Ø 13 mm 108 mm/108 mm	3,000 × <i>g</i> 4,000 rpm 16.8 cm
	Blood collection tube 3 to 15 mL 16/64	 5810 748.003	flat Ø 16 mm 108 mm/108 mm	3,000 × <i>g</i> 4,000 rpm 16.8 cm
	Vessel 7 to 17 mL 16/64	 5810 721.008	flat Ø 17.5 mm 118 mm/118 mm	3,000 × <i>g</i> 4,000 rpm 16.8 cm
	Conical tube 15 mL 12/48	 5810 722.004	conical Ø 17.5 mm 119 mm/121 mm	3,100 × <i>g</i> 4,000 rpm 17.3 cm
	Conical tube 50 mL 5/20	 5810 723.000	conical Ø 31 mm 116 mm/122 mm	3,100 × <i>g</i> 4,000 rpm 17.3 cm
	Centriprep 50 mL 5/20	 5810 739.004	flat Ø 31 mm -/121 mm	3,100 × <i>g</i> 4,000 rpm 17.3 cm
	Conical tube, skirted 50 mL 5/20	 5810 739.004  5804 737.008	flat Ø 31 mm -/119 mm	3,100 × <i>g</i> 4,000 rpm 17.3 cm
	Bottles 180 to 250 mL 1/4	 5825 722.000	flat Ø 62 mm -/133 mm	3,100 × <i>g</i> 4,000 rpm 17.3 cm

Vessel	Vessel Capacity Vessels per adapter/rotor	Adapters Order no. (international)	Adapter bottom shape Tube diameter Max. tube length with/without aerosol-tight bucket cap	Max. g-force Max. speed Centrifugation radius
	Wide-neck bottle 400 mL 1/4	 5810 728.002	flat Ø 81 mm -/133 mm	3,220 × <i>g</i> 4,000 rpm 18.0 cm
	Wide-neck bottle, rectangular 500 mL -/4	-	flat 83 mm 134 mm/134 mm	3,220 × <i>g</i> 4,000 rpm 18.0 cm

2.4.1.2 Rotor A-4-81 with conical tubes

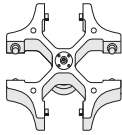
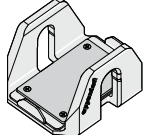
		Max. g-force: 3,220 × <i>g</i>
Rotor A-4-81 Swing-bucket rotor with 4 buckets for conical tubes	Bucket for 7 × 50 mL conical tubes	Max. speed: 4,000 rpm Max. load per bucket 7 × 75 g (adapter, tube and contents):

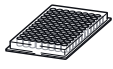
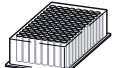
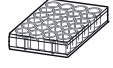


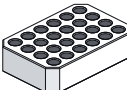

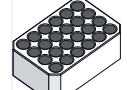
Vessel	Vessel Capacity Vessels per adapter/rotor	Adapters Order no. (international)	Bottom shape Tube diameter Max. tube length	Max. g-force Max. speed Centrifugation radius
	Conical tube 15 mL 7/28	 5820 718.005	conical Ø 17.5 mm 120 mm	3,184 × <i>g</i> 4,000 rpm 17.8 cm
	Conical tube 50 mL 7/28	-	conical Ø 30 mm 117 mm	3,220 × <i>g</i> 4,000 rpm 18.0 cm


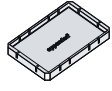
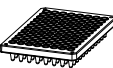
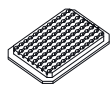

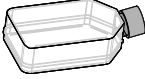
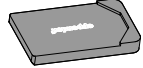
Product description

Centrifuge 5804/5804 R/5810/5810 R
English (EN)

2.4.1.3 Rotor A-4-81 with MTP/Flex bucket

		Max. g-force: 2,900 × <i>g</i>
Rotor A-4-81 Swing-bucket rotor with 4 MTP/Flex carriers	MTP/Flex buckets	Max. speed: 4,000 rpm Max. load per bucket 380 g (adapter, plate and contents):

Vessel	Plate Capacity Plates, rack or glass slides per adapter/rotor	Adapters Order no. (international)	Bottom shape Tube diameter Max. loading height	Max. g-force Max. speed Centrifugation radius
	Micro test plate 96/384 wells 4/16	-	flat - 60 mm	2,900 × <i>g</i> 4,000 rpm 16.3 cm
	Deepwell plate 96 wells 1/4	-	flat - 60 mm	2,900 × <i>g</i> 4,000 rpm 16.3 cm
	Cell culture plate 2/8	-	flat - 60 mm	2,900 × <i>g</i> 4,000 rpm 16.3 cm
	Kit 1/4	-	flat - 60 mm	2,900 × <i>g</i> 4,000 rpm 16.3 cm
	Tube in IsoRack 24 x 0.5 mL 1/4	 5825 708.008	flat Ø 6 mm 60 mm	2,700 × <i>g</i> 4,000 rpm 15.0 cm
	Tube in IsoRack 24 x 1.5/2 mL 1/4	 5825 709.004	flat Ø 11 mm 60 mm	2,600 × <i>g</i> 4,000 rpm 14.6 cm

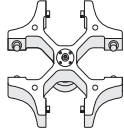
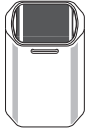

Vessel	Plate Capacity Plates, rack or glass slides per adapter/rotor	Adapters Order no. (international)	Bottom shape Tube diameter Max. loading height	Max. g-force Max. speed Centrifugation radius
	384-well PCR plate 1/4	 5825 713.001	flat - 60 mm	2,700 × <i>g</i> 4,000 rpm 15.8 cm
	96-well PCR plate 1/4	 5825 711.009	flat - 60 mm	2,600 × <i>g</i> 4,000 rpm 16.1 cm
Slides	CombiSlide 12 slides 12/48	 5825 706.005	flat - 60 mm	1,000 × <i>g</i> 2,372 rpm 15.9 cm
	Cell culture bottle with/without filter 75 cm ² : Sarstedt 83.1811.002/ 83.1811 25 cm ² : Sarstedt 83.1810.002/ 83.1810 Greiner Bio-One 690175/690160 TPP 90026/90025 IWAKI 3102-025 1/4	 5825 719.000	flat - 60 mm	1,000 × <i>g</i> 2,501 rpm 14.3 cm







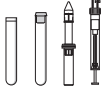



Product description




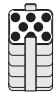









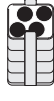
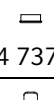


Centrifuge 5804/5804 R/5810/5810 R
English (EN)

2.4.2 Rotor A-4-62 and A-4-62-MTP (only 5810/5810 R)





2.4.2.1 Rotor A-4-62 with 250 mL rectangular bucket

			Max. g-force: 3,220 × <i>g</i>
Rotor A-4-62	Rectangular bucket 250 mL	Aerosol-tight cap	Max. speed: 4,000 rpm
Swing-bucket rotor with 4 × 250 mL rectangular buckets			Max. load per bucket (adapter, tube and contents): 620 g

Vessel	Vessel Capacity Vessels per adapter/rotor	Adapters Order no. (international)	Adapter bottom shape Tube diameter Max. tube length with/without aerosol-tight bucket cap	Max. g-force Max. speed Centrifugation radius
	Vessel 1.5/2 mL 16/64	 5810 751.004	flat Ø 11 mm 43 mm/43 mm	3,000 × <i>g</i> 4,000 rpm 17.1 cm
	Vessels 1.2 to 5 mL 25/100	 5810 750.008	flat Ø 11 mm 115 mm/123 mm	3,050 × <i>g</i> 4,000 rpm 17.3 cm
	Vessels 2.6 to 7 mL 15/60	 5810 752.000	flat Ø 13 mm 118 mm/121 mm	3,050 × <i>g</i> 4,000 rpm 17.3 cm
	Vessels 3 to 15 mL 12/48	 5810 753.007	flat Ø 16 mm 116 mm/121 mm	3,050 × <i>g</i> 4,000 rpm 17.3 cm
	Vessels 7 to 17 mL 12/48	 5810 754.003	flat Ø 17.5 mm 114 mm/118 mm	3,050 × <i>g</i> 4,000 rpm 17.3 cm

Vessel	Vessel Capacity Vessels per adapter/rotor	Adapters Order no. (international)	Adapter bottom shape Tube diameter Max. tube length with/without aerosol-tight bucket cap	Max. g-force Max. speed Centrifugation radius
	Conical tube 15 mL 9/36	 5810 755.000	conical Ø 17.5 mm 121 mm/127 mm	3,150 × g 4,000 rpm 17.8 cm
	Vessel 7 to 18 mL 8/32	 5810 756.006	flat Ø 20 mm 119 mm/126 mm	3,050 × g 4,000 rpm 17.3 cm
	Vessel 18 to 30 mL 4/16	 5810 757.002	flat Ø 26 mm 116 mm/119 mm	3,050 × g 4,000 rpm 17.3 cm
	Conical tube 50 mL 3/12	 5810 758.009	conical Ø 31 mm 116 mm/122 mm	3,150 × g 4,000 rpm 17.8 cm
	Conical tube 50 mL 4/16	 5810 763.002	conical Ø 31 mm -/122 mm	3,050 × g 4,000 rpm 17.3 cm
	Vessel 30 to 50 mL 4/16	 5810 759.005	flat Ø 31 mm -/119 mm	3,050 × g 4,000 rpm 17.3 cm
	Conical tube, skirted 50 mL 4/16	 5810 759.005  5804 737.008	flat Ø 31 mm -/119 mm	3,050 × g 4,000 rpm 17.3 cm
	Vessel 50 to 75 mL 2/8	 5810 760.003	flat Ø 35 mm 118/122 mm	3,050 × g 4,000 rpm 17.3 cm

Product descriptionCentrifuge 5804/5804 R/5810/5810 R
English (EN)

Vessel	Vessel Capacity Vessels per adapter/rotor	Adapters Order no. (international)	Adapter bottom shape Tube diameter Max. tube length with/without aerosol-tight bucket cap	Max. g-force Max. speed Centrifugation radius
	Vessel 80 to 120 mL 1/4	 5810 761.000	flat Ø 45 mm 125/138 mm	3,050 × <i>g</i> 4,000 rpm 17.3 cm
	Bottles 180 to 250 mL 1/4	 5810 770.009	flat Ø 62 mm 127/136 mm	3,220 × <i>g</i> 4,000 rpm 18.0 cm

2.4.2.2 Rotor A-4-62 with MTP bucket

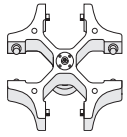
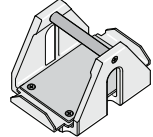
		Max. g-force:	2,750 × <i>g</i>
Rotor A-4-62 Swing-bucket rotor with 4 MTP buckets	MTP buckets	Max. speed:	4,000 rpm
		Max. load per bucket (adapter, plate and contents)	380 g

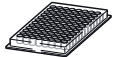
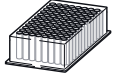
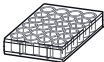



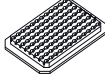
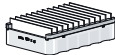

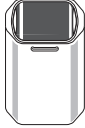

Plate	Plate Capacity Plates or glass slides per adapter/rotor	Adapters Order no. (international)	Bottom shape Max. loading height	Max. g-force Max. speed Centrifugation radius
	Micro test plate 96/384 wells 4/16		flat 53 mm	2,750 × <i>g</i> 4,000 rpm 15.4 cm
	Deepwell plate 96/384 wells 1/4		flat 53 mm	2,750 × <i>g</i> 4,000 rpm 15.4 cm









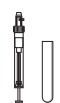

Plate	Plate Capacity Plates or glass slides per adapter/rotor	Adapters Order no. (international)	Bottom shape Max. loading height	Max. g-force Max. speed Centrifugation radius
	Cell culture plate 2/8		flat 53 mm	2,750 × <i>g</i> 4,000 rpm 15.4 cm
	384-well PCR plate 1/4	 5825 713.001	flat 53 mm	2,700 × <i>g</i> 4,000 rpm 14.9 cm
	96-well PCR plate 1/4	 5825 711.009	flat 53 mm	2,600 × <i>g</i> 4,000 rpm 15.2 cm
Slides	CombiSlide 12 slides 12/48	 5825 706.005	flat 53 mm	1,000 × <i>g</i> 2,442 rpm 15.0 cm
















Product description

Centrifuge 5804/5804 R/5810/5810 R
English (EN)

2.4.3 Rotor A-4-44










			Max. g-force: 4,400 × <i>g</i>
Rotor A-4-44	Rectangular bucket 100 mL	Aerosol-tight cap	Max. speed: 5,000 rpm
Swing-bucket rotor with 4 × 100 mL rectangular buckets			Max. load per bucket (adapter, tube and contents): 310 g

Vessel	Vessel	Adapters	Adapter bottom shape	Max. g-force
	Capacity	Order no. (international)	Tube diameter	Max. speed
	Vessels per adapter/rotor		Max. tube length with/without aerosol-tight bucket cap	Centrifugation radius
	Vessel 1.5/2 mL 12/48	 5804 751.000	flat Ø 11 mm 43 mm/43 mm	4,100 × <i>g</i> 5,000 rpm 14.8 cm
	Vessels 1.2 to 5 mL 14/56	 5804 750.004	flat Ø 11 mm 102 mm/105 mm	4,200 × <i>g</i> 5,000 rpm 15.0 cm
	Vessels 2.6 to 7 mL 9/36	 5804 752.007	flat Ø 13 mm 106 mm/108 mm	4,200 × <i>g</i> 5,000 rpm 15.0 cm
	Vessels 3 to 15 mL 7/28	 5804 753.003	flat Ø 16 mm 106 mm/108 mm	4,200 × <i>g</i> 5,000 rpm 15.0 cm
	Vessels 7 to 17 mL 6/24	 5804 754.000	flat Ø 17.5 mm 106 mm/110 mm	4,200 × <i>g</i> 5,000 rpm 15.0 cm

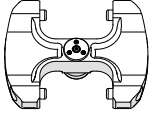
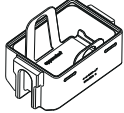
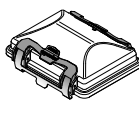
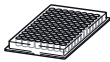
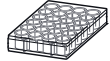
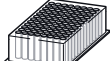
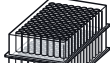

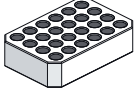

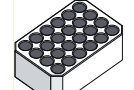
Vessel	Vessel Capacity Vessels per adapter/rotor	Adapters Order no. (international)	Adapter bottom shape Tube diameter Max. tube length with/without aerosol-tight bucket cap	Max. g-force Max. speed Centrifugation radius
	Conical tube 15 mL 4/16	 5804 755.006	conical Ø 17.5 mm -/121 mm	4,300 × g 5,000 rpm 15.5 cm
	Conical tube 15 mL 2/8	 5804 717.007	conical Ø 17.5 mm 121 mm/121 mm	4,400 × g 5,000 rpm 15.7 cm
	Vessel 7 to 18 mL 4/16	 5804 756.002	flat Ø 20 mm 104 mm/107 mm	4,200 × g 5,000 rpm 15.0 cm
	Vessel 18 to 30 mL 2/8	 5804 757.009	flat Ø 26 mm 100 mm/110 mm	4,200 × g 5,000 rpm 15.0 cm
	Conical tube 50 mL 1/4	 5804 758.005	conical Ø 31 mm -/122 mm	4,300 × g 5,000 rpm 15.5 cm
	Conical tube 50 mL 1/4	 5804 718.003	conical Ø 31 mm 119 mm/122 mm	4,400 × g 5,000 rpm 15.7 cm
	Conical tube 50 mL -/8	 5804 706.005  Max. load 144 g (insert, tubes and contents)	flat with conical insert - -/120 mm	4,500 × g 5,000 rpm 16.1 cm

Product description

Centrifuge 5804/5804 R/5810/5810 R
English (EN)


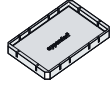

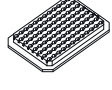
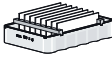
Vessel	Vessel Capacity Vessels per adapter/rotor	Adapters Order no. (international)	Adapter bottom shape Tube diameter Max. tube length with/without aerosol-tight bucket cap	Max. g-force Max. speed Centrifugation radius
	Vessel 30 to 50 mL 1/4	 5804 759.001	flat Ø 31 mm 108 mm/122 mm	4,200 × <i>g</i> 5,000 rpm 15.0 cm
	Conical tube, skirted 50 mL 1/4	 5804 759.001  5804 737.008	flat Ø 31 mm 108 mm/122 mm	4,200 × <i>g</i> 5,000 rpm 15.0 cm
	Vessel 50 to 75 mL 1/4	 5804 760.000	flat Ø 35 mm 108 mm/119 mm	4,200 × <i>g</i> 5,000 rpm 15.0 cm
	Vessel 80 to 100 mL 1/4	 5804 761.006	flat Ø 45 mm 100 mm/114 mm	4,200 × <i>g</i> 5,000 rpm 15.0 cm

2.4.4 Rotor A-2-DWP-AT (only 5810/5810 R)

			Max. g-force:	3,486 × g
A-2-DWP rotor	Bucket	Aerosol-tight cap	Max. speed:	4,500 rpm
Swing-bucket rotor with 2 aerosol-tight buckets	(always use with plate carrier)		Max. load per bucket (adapter, plate and contents):	500 g
Plate	Plate	Adapters	Adapter bottom shape	Max. g-force
	Capacity	Order no. (international)		Max. speed
	Plate/ slide per adapter/rotor		Max. loading height	Centrifugation radius
	Micro test plate 96/384 wells 4/16	-	60 mm	3,486 × g 4,500 rpm 154 mm
	Cell culture plate 2/8	-	60 mm	3,486 × g 4,500 rpm 154 mm
	Deepwell plate 96 mL 1/4		67 mm	flat 3,486 × g 4,500 rpm 154 mm
	Kit 1/4	-	60 mm	3,486 × g 4,500 rpm 154 mm
	IsoRack 24 × 0.5 mL micro test tubes 1/4		open Ø 6 mm 60 mm	2,500 × g 3,900 rpm 147 mm
	IsoRack 24 × 1,5/2,0 mL micro test tubes 1/4		open Ø 11 mm 60 mm	2,432 × g 3.900 g 143 mm

Product description

Centrifuge 5804/5804 R/5810/5810 R
English (EN)

Plate	Plate Capacity Plate/ slide per adapter/rotor	Adapters Order no. (international)	Adapter bottom shape Max. loading height	Max. g-force Max. speed Centrifugation radius
	PCR plate 384 wells 1/4	 5825 713.001	60 mm	$3,486 \times g$ 4,500 rpm 149 mm
	PCR plate 96 wells 1/4	 5825 711.009	60 mm	$3,486 \times g$ 4,500 rpm 154 mm
Slides	CombiSlide 8 slides 8/16	 5825 706.005	flat 60 mm	$100 \times g$ 772 rpm 150 mm

2.4.5 A-2-DWP rotor



Check the load if using two fully loaded DWP plates.

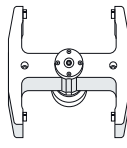
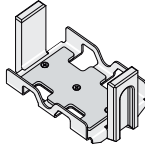
		Max. g-force:	$2,250 \times g$
A-2-DWP rotor Swing-bucket rotor with 2 Deepwell plate buckets	Deepwell plate bucket	Max. speed:	3,700 rpm
		Max. load per bucket (adapter, plate and contents):	380 g

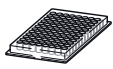
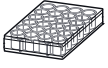



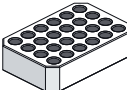

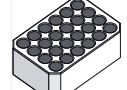


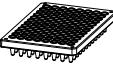


Plate	Plate Capacity Plates/slides per adapter/rotor	Adapters Order no. (international)	Adapter bottom shape Max. loading height	Max. g-force Max. speed Centrifugation radius
	Micro test plate 96/384 wells 4/8	SBS adapter* 5825 718.003	flat 89 mm	$2,250 \times g$ 3,700 rpm 14.7 cm

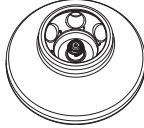
Plate	Plate Capacity Plates/slides per adapter/rotor	Adapters Order no. (international)	Adapter bottom shape Max. loading height	Max. g-force Max. speed Centrifugation radius
	Cell culture plate 4/8	SBS adapter* 5825 718.003	flat 89 mm	2,250 × g 3,700 rpm 14.7 cm
	Deepwell plate 96 wells 2/4	SBS adapter* 5825 718.003	flat 89 mm	2,250 × g 3,700 rpm 14.7 cm
	Kit 1/2	SBS adapter* 5825 718.003	flat 89 mm	2,250 × g 3,700 rpm 14.7 cm
	Tube in IsoRack 24 x 0.5 mL 1/2	 5825 708.008	flat Ø 6 mm 89 mm	2,050 × g 3,700 rpm 13.8 cm
	Tube in IsoRack 24 x 1.5/2 mL 1/2	 5825 709.004	flat Ø 11 mm 89 mm	1,990 × g 3,700 rpm 13.3 cm
	384-well PCR plate 1/2	 5825 713.001	flat 89 mm	2,170 × g 3,700 rpm 14.2 cm
	96-well PCR plate 1/2	 5825 711.009	flat 89 mm	2,220 × g 3,700 rpm 14.5 cm
Slides	CombiSlide 8 slides 8/16	 5825 706.005	flat 60 mm	100 × g 791 rpm 14.3 cm












*) Optional. Secures the plate against slipping.











Product description

Centrifuge 5804/5804 R/5810/5810 R
English (EN)

2.4.6 Rotor FA-45-6-30

	Rotor FA-45-6-30 Fixed-angle rotor for 6 conical tubes	Max. g-force: 16,639 × <i>g</i> (5810 R: 20,133 × <i>g</i>)
		Max. speed: 11,000 rpm (5810 R: 12,100 rpm)
		Max. load (adapter, tube and contents): 6 × 75 g

Vessel	Vessel Capacity Vessels per adapter/rotor	Adapters Order no. (international)	Adapter bottom shape Tube diameter Max. tube length with rotor lid	Max. g-force at 11,000 rpm (5804/ 5804 R/5810) Max. g-force at 12,100 rpm (5810 R) Centrifugation radius
	Conical tube 15 mL 1/6	 5820 717.009	conical Ø 17 mm 125 mm	16,233 × <i>g</i> 19,642 × <i>g</i> 12.0 cm
	Conical tube 50 mL 1/6	-	conical Ø 30 mm 127 mm	16,639 × <i>g</i> 20,133 × <i>g</i> 12.3 cm
	Oak Ridge 16 mL 1/6	 5820 720.000	Round Ø 18.1 mm 107 mm	16,233 × <i>g</i> 19,642 × <i>g</i> 12.0 cm
	Oak Ridge 30 mL 1/6	 5820 721.006	Round Ø 25.7 mm 104 mm	14,204 × <i>g</i> 17,187 × <i>g</i> 10.5 cm
	Oak Ridge 35 mL 1/6	 5820 722.002	conical Ø 28.7 mm 113 mm	15,151 × <i>g</i> 18,333 × <i>g</i> 11.2 cm
	Vessel 5 mL 1/6	 5820 730.005	conical Ø 17 mm -	16,369 × <i>g</i> 19,806 × <i>g</i> 12,1 cm

Vessel	Vessel Capacity Vessels per adapter/rotor	Adapters Order no. (international)	Adapter bottom shape Tube diameter Max. tube length with rotor lid	Max. g-force at 11,000 rpm (5804/ 5804 R/5810) Max. g-force at 12,100 rpm (5810 R) Centrifugation radius
	Vessel 2,6 to 5 mL 1/6	 5820 726.008	Round Ø 13,5 mm -	16,233 × g 19,246 × g 12.0 cm
	Vessel 4 to 8 mL 1/6	 5820 725.001	Round Ø 13,5 mm 119 mm	16,233 × g 19,246 × g 12.0 cm
	Vessel 5.5 mL – 10 mL 1/6	 5820 728.000	Round Ø 16 mm -	16,233 × g 19,246 × g 12.0 cm
	Vessel 7.5 to 12 mL 1/6	 5820 727.004	Round Ø 16.4 mm 119 mm	16,233 × g 19,246 × g 12.0 cm
	Vessel 9 mL 1/6	 5820 729.007	Round Ø 16.4 mm 112 mm	16,233 × g 19,246 × g 12.0 cm

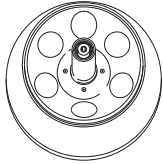














- ▶ Do not use Corning® 50 mL PET Centrifuge Tubes in the rotor FA-45-6-30. These tubes may remain stuck in the bore holes after centrifugation.










Product description

Centrifuge 5804/5804 R/5810/5810 R
English (EN)

2.4.7 Rotor F-34-6-38

	Rotor F-34-6-38 Fixed-angle rotor for 6 x 85 mL tubes	Max. g-force: 15,557 × <i>g</i> (5810 R: 18,514 × <i>g</i>)
		Max. speed: 11,000 rpm (5810 R: 12,000 rpm)
		Max. load (adapter, tube and contents): 6 × 125 g


Vessel	Vessel Capacity Vessels per adapter/rotor	Adapters Order no. (international)	Adapter bottom shape Tube diameter Max. tube length with rotor lid	Max. g-force at 11,000 rpm (5804/ 5804 R/5810) Max. g-force at 12,000 rpm (5810 R) Centrifugation radius
	Vessel 1.5/2 mL 4/24	 5804 770.005	Round Ø 11 mm 43 mm	15,300 × <i>g</i> 18,200 × <i>g</i> 11.3 cm
	Vessel 5 mL 1/6	 5804 777.000	conical Ø 17 mm -	14,150 × <i>g</i> 16,842 × <i>g</i> 10,45 cm
	Blood collection tube 2 mL to 5 mL 3/18	 5804 738.004	Round Ø 13 mm 80 mm	14,339 × <i>g</i> 17,065 × <i>g</i> 10.6 cm
	Blood collection tube 4 mL to 7 mL 3/18	 5804 739.000	Round Ø 13 mm 107 mm	15,442 × <i>g</i> 18,353 × <i>g</i> 11.4 cm
	Vessel 7 to 15 mL 2/12	 5804 771.001	Round Ø 16 mm 112 mm	15,150 × <i>g</i> 18,000 × <i>g</i> 11.2 cm
	Conical tube 15 mL 1/6	 5804 776.003	conical Ø 17.5 mm 123 mm	14,450 × <i>g</i> 17,200 × <i>g</i> 10.7 cm










Vessel	Vessel Capacity Vessels per adapter/rotor	Adapters Order no. (international)	Adapter bottom shape Tube diameter Max. tube length with rotor lid	Max. g-force at 11,000 rpm (5804/ 5804 R/5810) Max. g-force at 12,000 rpm (5810 R) Centrifugation radius
	Vessel 15 to 18 mL 1/6	 5804 772.008	Round Ø 18 mm 123 mm	14,750 × <i>g</i> 17,550 × <i>g</i> 10.9 cm
	Vessel 20 mL to 30 mL 1/6	 5804 773.004	Round Ø 26 mm 123 mm	14,900 × <i>g</i> 17,700 × <i>g</i> 11.0 cm
	Vessel 50 mL 1/6	 5804 774.000	Round Ø 29 mm 123 mm	15,157 × <i>g</i> 18,014 × <i>g</i> 11.2 cm
	Conical tube 50 mL 1/6	 5804 775.007	conical Ø 29.5 mm 121 mm	14,600 × <i>g</i> 17,400 × <i>g</i> 10.8 cm
	Vessel 85 mL -/6	-	- Ø 38 mm 121 mm	15,550 × <i>g</i> 18,500 × <i>g</i> 11.5 cm

Product description


Centrifuge 5804/5804 R/5810/5810 R
English (EN)



2.4.8 Rotor FA-45-30-11 and F-45-30-11

	Rotor FA-45-30-11 Aerosol-tight fixed-angle rotor for 30 tubes Rotor F-45-30-11 Fixed-angle rotor for 30 tubes	Max. g-force: 20,817 × <i>g</i>
		Max. speed: 14,000 rpm
		Max. load (adapter, tube and contents): 30 × 3.5 g


Vessel	Vessel Capacity Vessels per adapter/rotor	Adapters Order no. (international)	Adapter bottom shape Tube diameter	Max. g-force Max. speed Centrifugation radius
	Vessel 1.5/2 mL -/30	-	- Ø 11 mm	20,817 × <i>g</i> 14,000 rpm 9.5 cm
	PCR tube 0.2 mL 1/30	 5425 715.005	conical Ø 6 mm	16,200 × <i>g</i> 14,000 rpm 7.4 cm
	Vessel 0.4 mL 1/30	 5425 717.008	conical Ø 6 mm	20,817 × <i>g</i> 14,000 rpm 9.5 cm
	Vessel 0.5 mL 1/30	 5425 716.001	- Ø 8 mm	18,400 × <i>g</i> 14,000 rpm 8.4 cm
	Microtainers 0.6 mL 1/30	 5425 716.001	- Ø 8 mm	20,817 × <i>g</i> 14,000 rpm 9.5 cm



2.4.9 Rotor F-45-48-PCR

	Rotor F-45-48-PCR Fixed-angle rotor for tube strips or 0.2 mL PCR tubes	Max. g-force: 15,294 × <i>g</i>
		Max. speed: 12,000 rpm
		Max. load (tube and contents): 6 × 3.5 g

Vessel	Vessel Capacity Vessels per adapter/rotor	Adapters	Tube diameter	Max. g-force Max. speed Centrifugation radius
	8-tube/5-tube-tube strips 8/5 × 0,2 mL -/6 × 8 and/or -/ 6 × 5	-	Ø 6 mm	15,294 × <i>g</i> 12,000 rpm 9.5 cm
	Vessel 0.2 mL -/48	-	Ø 6 mm	15,294 × <i>g</i> 12,000 rpm 9.5 cm




2.4.10 Rotor T-60-11












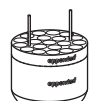
	Rotor T-60-11 Drum rotor for tubes	Max. g-force: 14,000 × <i>g</i>
		Max. speed: 16.435 rpm
		Max. load (tube and contents): 6 × 70 g




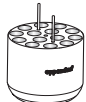










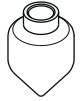

Vessel	Vessel Capacity Vessels per adapter/rotor	Adapters	Tube diameter	Max. g-force Max. speed Centrifugation radius
	Vessel 1.5/2 mL 10/60	-	Ø 11 mm	16,435 × <i>g</i> 14,000 rpm 7.5 cm
	Vessel 0.4 mL 20/120	-	Ø 6 mm	16,435 × <i>g</i> 14,000 rpm 7.5 cm

Product descriptionCentrifuge 5804/5804 R/5810/5810 R
English (EN)

2.4.11 Rotor S-4-104 (only 5810/5810 R)

			Max. <i>g</i> -force:	3214 × <i>g</i>
Rotor S-4-104	Round bucket 750 mL	Aerosol-tight cap	Max. speed:	3900 rpm
Swing-bucket rotor with 4 × 750 mL round buckets			Max. load per bucket (adapter, tube and contents):	1000 g

Tube	Tube Capacity Tubes per adapter/ rotor	Adapter Order no. (international)	Adapter bottom shape Tube diameter Max. tube length with/without aerosol- tight bucket cap	Max. <i>g</i>-force Max. speed Centrifugation radius
	Reaction tube 1.5/2 mL 50/200	 5825 740.009	open Ø 11 mm 39 mm	3197 × <i>g</i> 3900 rpm 18.8 cm
	Reaction tube 5 mL 14/56	 5825 739.000	conical Ø 17 mm 60 mm	3214 × <i>g</i> 3900 rpm 18.9 cm
	Round-bottom tube Ø 12 mm × 75 mm 27/108	 5825 747.003	round Ø 12 mm 108 mm/115 mm	3163 × <i>g</i> 3900 rpm 18.3 cm
	Tube 4 to 8 mL 23/92	 5825 738.004	round Ø 13 mm × 100 mm 108 mm/115 mm	3044 × <i>g</i> 3900 rpm 17.9 cm
	Tube 7.5 to 12 mL 20/80	 5825 736.001	round Ø 16 mm × 98 mm 114 mm/119 mm	3061 × <i>g</i> 3900 rpm 18 cm
	Tube 8 to 16 mL 7/28 (load inner bore only (Fig. 5-5 on p. 62))	 5825 736.001	round Ø 16 mm (Do not use aerosol-tight cap.)/ 125 mm	3061 × <i>g</i> 3900 rpm 18 cm

Tube	Tube Capacity Tubes per adapter/ rotor	Adapter Order no. (international)	Adapter bottom shape Tube diameter Max. tube length with/without aerosol- tight bucket cap	Max. <i>g</i> -force Max. speed Centrifugation radius
	Tube 9 mL 20/80	 5825 743.008	round Ø 17.5 mm × 100 mm 106 mm/111 mm	3044 × <i>g</i> 3900 rpm 17.9 cm
	Round-bottom tube 14 mL 14/56	 5825 748.000	round Ø 17.5 mm 112 mm/117 mm	3146 × <i>g</i> 3900 rpm 18.5 cm
	Conical tube 15 mL 14/56	 5825 734.009	conical Ø 17 mm × 104 mm 120 mm/125 mm	3197 × <i>g</i> 3900 rpm 18.8 cm
	Conical tube 50 mL 7/28	 5825 733.002	conical Ø 29 mm × 109 mm 116 mm/122 mm	3180 × <i>g</i> 3900 rpm 18.7 cm
	Conical tube, skirted 50 mL 5/20	 5825 732.006	conical Ø 29 mm × 104 mm 116 mm/120 mm	3027 × <i>g</i> 3900 rpm 17.8 cm
	Centrifuge bottle 175 - 250 mL 1/4	 5825 741.005	flat Ø 62 mm × 129 mm 125 mm/145 mm	3112 × <i>g</i> 3900 rpm 18.3 cm
	Wide-neck bottle 750 mL 1/4	 5825 744.004	flat Ø 102 mm × 132 mm (Do not use aerosol-tight cap.)/ 150 mm	3146 × <i>g</i> 3900 rpm 18.5 cm
	Centrifuge bottle Corning 500 mL 1/4	 5825 745.000	conical Ø 96 mm (Do not use aerosol-tight cap.)/ 147 mm	3162 × <i>g</i> 3900 rpm 18.6 cm

Product description

Centrifuge 5804/5804 R/5810/5810 R
English (EN)

**NOTICE! Buckets swinging out in the wrong direction.**

When working with the rotor S-4-104, using the wrong adapters with 500 mL Corning tubes may lead to the loss of samples or damage to the centrifuge.

- ▶ Only use the Eppendorf adapter intended for this purpose.



Do not use an aerosol-tight bucket cap with Corning 50 mL conical tubes.




			Max. g-force: 2568 × <i>g</i>
Rotor S-4-104 Swing-bucket rotor with 4 × plate buckets	Plate bucket (always use with plate carrier and bottom element)	Aerosol-tight cap	Max. speed: 3900 rpm Max. load per bucket 530 g (plate carrier/rotor removal tool, bottom element, plate and contents):

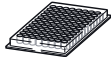
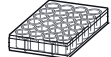
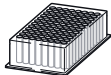


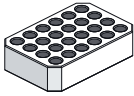

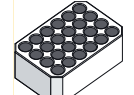

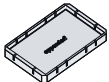
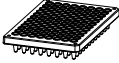
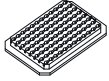
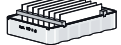
Plate	Plate Capacity Plates/slides per adapter/rotor	Adapter Order no. (international)	Adapter bottom shape Max. loading height	Max. g-force Max. speed Centrifugation radius
	Microplate 96/384 wells 4/16	–	flat – 47 mm/60 mm	2568 × <i>g</i> 3900 rpm 15.1 cm
	Cell culture plate 2/8	–	flat – 47 mm/60 mm	2568 × <i>g</i> 3900 rpm 15.1 cm
	Deepwell plate 96 wells 1/4	–	flat – 47 mm/60 mm	2568 × <i>g</i> 3900 rpm 15.1 cm
	Kit 1/4	–	flat – 47 mm/60 mm	2568 × <i>g</i> 3900 rpm 15.1 cm

Plate	Plate Capacity Plates/slides per adapter/rotor	Adapter Order no. (international)	Adapter bottom shape Max. loading height	Max. <i>g</i> -force Max. speed Centrifugation radius
	IsoRack 24 × 0.5 mL micro test tubes 1/4	 5825 708.008	open Ø 6 mm 47 mm/60 mm	2449 × <i>g</i> 3900 rpm 14.4 cm
	IsoRack 24 × 1.5/2 mL micro test tubes 1/4	 5825 709.004	open Ø 11 mm 47 mm/60 mm	2381 × <i>g</i> 3900 rpm 14.0 cm
	PCR plate 384 wells 1/4	 5825 713.001	flat 47 mm/60 mm	2415 × <i>g</i> 3900 rpm 14.2 cm
	PCR plate 96 wells 1/2	 5825 711.009	conical 47 mm/60 mm	2449 × <i>g</i> 3900 rpm 14.4 cm
Slide	CombiSlide 12 slides 12/48	 5825 706.005	flat 47 mm/60 mm	1000 × <i>g</i> 2467 rpm 14.7 cm

Product description

Centrifuge 5804/5804 R/5810/5810 R
English (EN)



		Max. g-force: 2568 × g
Rotor S-4-104 Swing-bucket rotor with 4 × plate buckets	Plate bucket (always use with plate holder)	Max. speed: 3900 rpm
		Max. load per bucket (adapter, plate and contents): 450 g

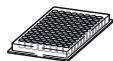
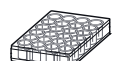
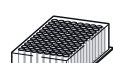


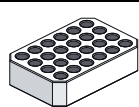

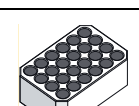

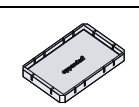

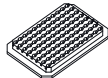
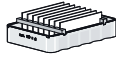






Plate	Plate Capacity Plates/slides per adapter/rotor	Adapter Order no. (international)	Adapter bottom shape Max. loading height	Max. g-force Max. speed Centrifugation radius
	Microplate 96/384 wells 4/16	–	flat – 47 mm/60 mm	2568 × g 3900 rpm 15.1 cm
	Cell culture plate 2/8	–	flat – 47 mm/60 mm	2568 × g 3900 rpm 15.1 cm
	Deepwell plate 96 wells 1/4	–	flat – 47 mm/60 mm	2568 × g 3900 rpm 15.1 cm
	Kit 1/4	–	flat – 47 mm/60 mm	2568 × g 3900 rpm 15.1 cm
	IsoRack 24 × 0.5 mL micro test tubes 1/4	 5825 708.008	open Ø 6 mm 47 mm/60 mm	2449 × g 3900 rpm 14.4 cm
	IsoRack 24 × 1.5/2 mL micro test tubes 1/4	 5825 709.004	open Ø 11 mm 47 mm/60 mm	2381 × g 3900 rpm 14.0 cm
	PCR plate 384 wells 1/4	 5825 713.001	flat 47 mm/60 mm	2415 × g 3900 rpm 14.2 cm

Plate	Plate Capacity Plates/slides per adapter/rotor	Adapter Order no. (international)	Adapter bottom shape Max. loading height	Max. g-force Max. speed Centrifugation radius
	PCR plate 96 wells 1/2	 5825 711.009	conical 47 mm/60 mm	2449 × g 3900 rpm 14.4 cm
Slide	CombiSlide 12 slides 12/48	 5825 706.005	flat 47 mm/60 mm	1000 × g 2467 rpm 14.7 cm















2.4.12 Rotor S-4-72

		Max. g-force: 3,234 × g
Rotor S-4-72 Swing-bucket rotor with 4 × 250 mL round buckets	Round bucket 250 mL	Max. speed: 4,200 rpm
		Max. load per bucket 450 g (adapter, tube and contents):

Vessel	Vessel Capacity Vessels per adapter/rotor	Adapters Order no. (international)	Adapter bottom shape Tube diameter Max. tube length	Max. g-force Max. speed Centrifugation radius
	Vessel 1.5/2 mL 26/104	 5804 794.001	continuous Ø 11 mm 43 mm	3,136 × g 4,200 rpm 15.9 cm
	Vessel 5 mL 8/32	 5804 793.005	conical Ø 17 mm × 60 mm	3,215 × g 4,200 rpm 16.3 cm

Product description


Centrifuge 5804/5804 R/5810/5810 R
English (EN)





Vessel	Vessel Capacity Vessels per adapter/rotor	Adapters Order no. (international)	Adapter bottom shape Tube diameter Max. tube length	Max. g-force Max. speed Centrifugation radius
	Vessel 4 to 8 mL 14/56	 5804 789.008	Round Ø 13 mm × 104 mm 115 mm	3,136 × <i>g</i> 4,200 rpm 15.9 cm
	Vessel 7.5 to 12 mL 13/52	 5804 791.002	Round Ø 16 mm × 98 mm 112 mm	3,096 × <i>g</i> 4,200 rpm 15.7 cm
	Vessel 9 mL 12/48	 5804 792.009	Round Ø 17.5 mm × 100 mm 113 mm	3,116 × <i>g</i> 4,200 rpm 15.8 cm
	Conical tube 15 mL 8/32	 5804 783.000	conical Ø 17 mm × 104 mm 120 mm	3,234 × <i>g</i> 4,200 rpm 16.4 cm
	Conical tube 50 mL 4/16	 5804 784.006	conical Ø 29 mm × 109 mm 120 mm	3,234 × <i>g</i> 4,200 rpm 16.4 cm
	Conical tube, skirted 50 mL 2/8	 5804 785.002	conical Ø 29 mm × 104 mm 120 mm	3,027 × <i>g</i> 3,900 rpm 17.8 cm
	Centrifuge bottle 175 mL: BD 352076 250 mL: Nalgene 3120-0250/ 3122-0250 1/4	 5804 787.005	Round Ø 62 mm 130 mm	3,155 × <i>g</i> 4,200 rpm 16 cm



Only centrifuge conical tubes with the manufacturer's adapter.

2.4.13 Rotor F-35-48-17


	Max. g-force: 5,005 x <i>g</i>
Rotor F-35-48-17 Fixed-angle rotor with 48 steel cores	Max. speed: 5.500 rpm
	Max. load (sleeve, adapter, tube and contents): 48 x 56 g











Vessel	Vessel Capacity Vessels per adapter/rotor	Adapters Order no. (international)	Adapter bottom shape Tube diameter Max. tube length	Max. g-force Max. speed Centrifugation radius
	Vessel 7,5 to 12 mL 1/48		flat Ø 16 mm 127 mm	5,005 x <i>g</i> 5.500 rpm 14.8 cm
	Conical tube 15 mL 1/36		conical Ø 17 mm 127 mm	5,005 x <i>g</i> 5.500 rpm 14.8 cm

Product description

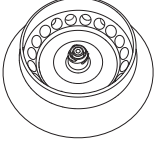
Centrifuge 5804/5804 R/5810/5810 R
English (EN)

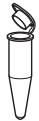






2.4.14 Rotor FA-45-48-11

	Max. g-force: Outer ring 19,083 × <i>g</i> Inner ring 16,816 × <i>g</i>
Rotor FA-45-48-11 Aerosol-tight fixed-angle rotor for 48 tubes	Max. speed: 13,000 rpm
	Max. load (adapter, tube and contents): 48 × 3.75 g

	Tube Capacity Tubes per adapter/rotor	Adapter Order no. (international)	Adapter bottom shape Tube diameter	Max. g-force
				Outer ring Inner ring Max. speed Centrifugation radius Outer ring Inner ring
	Reaction tube 1.5 to 2 mL -/48		round Ø 11 mm	19,083 × <i>g</i> 16,816 × <i>g</i> 13,000 rpm 10.1 cm 8.9 cm
	PCR tube 0.2 mL 1/48	 5425 715.005	conical Ø 6 mm	15,115 × <i>g</i> 12,848 × <i>g</i> 13,000 rpm 8 cm 6.8 cm
	Reaction tube 0.4 mL 1/48	 5425 717.008	conical Ø 6 mm	19,083 × <i>g</i> 16,816 × <i>g</i> 13,000 rpm 10.1 cm 8.9 cm
	Reaction tube 0.5 mL 1/48	 5425 716.001	– Ø 8 mm	17,005 × <i>g</i> 14,737 × <i>g</i> 13,000 rpm 9 cm 7.8 cm
	Reaction tube 0.6 mL 1/48	 5425 716.001	– Ø 8 mm	19,083 × <i>g</i> 16,816 × <i>g</i> 13,000 rpm 10.1 cm 8.9 cm

2.4.15 Rotor FA-45-20-17

	Max. g-force: 20,913 × <i>g</i>
Rotor FA-45-20-17 Aerosol-tight fixed-angle rotor for 20 tubes	Max. speed: 13,100 rpm
	Max. load (adapter, tube and contents): 20 × 9.5 g

Tube	Tube Capacity Tubes per adapter/rotor	Adapter Order no. (international)	Adapter bottom shape Tube diameter	Max. g-force Max. speed Centrifugation radius
	Reaction tube 1.5 mL/2.0 mL 1/20	 5820 768.002	open Ø 11 mm	18,227 × <i>g</i> 13,100 rpm 9.5 cm
	Reaction tube 5 mL -/20	–	conical Ø 17 mm	20,913 × <i>g</i> 13,100 rpm 10.9 cm
	HPLC vessels 1/20	 5820 770.007	open Ø 11 mm	17,076 × <i>g</i> 13,100 rpm 8.9 cm
	Cryo tube 1.0 mL/2.0 mL 1/12	 5820 769.009	flat Ø 13 mm	18,802 × <i>g</i> 13,100 rpm 9.8 cm

Product description

Centrifuge 5804/5804 R/5810/5810 R
English (EN)

3 Safety

3.1 Intended use

The Centrifuge 5804/5804 R/5810/5810 R is used for the separation of aqueous solutions and suspensions of different densities in approved sample tubes.

The Centrifuge 5804/5804 R/5810/5810 R is exclusively intended for use indoors. All country-specific safety requirements for operating electrical equipment in the laboratory must be observed.

3.2 User profile

This device may only be operated by trained specialist staff. They must have carefully read the operating manual and be familiar with the function of the device.

3.3 Application limits

3.3.1 Declaration concerning the ATEX directive (94/9/EC)



DANGER! Risk of explosion.

- ▶ Do not operate the device in areas where work is completed with explosive substances.
 - ▶ Do not use this device to process any explosive or highly reactive substances.
 - ▶ Do not use this device for processing any substances which could generate an explosive atmosphere.
-

Due to its design and the environmental conditions inside the device, the Centrifuge 5804/5804 R/5810/5810 R is not suitable for use in a potentially explosive atmosphere.

The device only must be used in a safe environment, such as the open environment of a ventilated laboratory or fume hood. The use of substances which could create a potentially explosive atmosphere is not permitted. The final decision on the risks associated with the use of these types of substances is the responsibility of the user.

3.3.2 Maximum service life for accessories

**WARNING! Risk of injury from chemically or mechanically damaged accessories.**

Even minor scratches and cracks can lead to serious internal material damage.

- ▶ Protect all accessory parts from mechanical damage.
- ▶ Inspect the accessories for damage before each use. Replace any damaged accessories.
- ▶ Do not use any rotor lids, buckets or caps showing signs of corrosion or mechanical damage (e.g. bending).
- ▶ Do not use any accessories whose maximum service life has been exceeded.
- ▶ When inserting the buckets and rotors, ensure that they do not become scratched.

**CAUTION! Risk of injury due to chemically damaged rotor lids or caps.**

Transparent rotor lids or caps made from PC, PP or PEI may lose their strength under the impact of organic solvents (e.g., phenol, chloroform).

- ▶ If rotor lids or caps have come into contact with organic solvents, they should be cleaned immediately.
- ▶ Regularly check the rotor lids and caps for damages and cracks.
- ▶ Immediately replace rotor lids or caps that have cracks or milky stains.


The rotors listed below, and the corresponding buckets and rotor lids, have a maximum service life of the number of years or cycles listed in the table (whichever comes first), starting with the initial start-up.

Rotor	Maximum service from commissioning onward	
A-2-DWP-AT	100,000 cycles	7 years
A-2-DWP	34,000 cycles	7 years
A-4-44	34,000 cycles	7 years
A-4-62	40,000 cycles	7 years
A-4-81	100,000 cycles	7 years
F-34-6-38	75,000 cycles	7 years
FA-45-6-30	100,000 cycles	7 years
FA-45-48-11	100,000 cycles	7 years
FA-45-20-17	100,000 cycles	7 years
F-35-48-17	100,000 cycles	7 years
S-4-72	100,000 cycles	7 years
S-4-104	100,000 cycles	7 years
T-60-11	n/a	7 years

Accessories	Maximum service from commissioning onward	
Aerosol-tight rotor lid, without replaceable seals	50 autoclaving cycles	–
Rotor lid QuickLock		3 years
Seals of the QuickLock rotor lid	50 autoclaving cycles	–
Rotor lid and caps made of polycarbonate (PC), polypropylene (PP) or polyetherimide (PEI)	50 autoclaving cycles	3 years
Adapter	–	1 year

For all other rotors and rotor lids of this centrifuge there is no service life limit as long as the following requirements are met:

- Proper use,
- Recommended maintenance
- Undamaged condition

The date of manufacture is stamped on the rotors in the format *03/12* (= March 2012) or on the inside of the plastic rotor lids in the form of a clock .

To ensure aerosol tightness, the following applies:

- Replace aerosol-tight rotor lids and caps after 50 autoclaving cycles.
- Replace the seal of QuickLock rotor lids after 50 autoclaving cycles.

3.4 Information on product liability

In the following cases, the designated protection of the device may be compromised. Liability for any resulting property damage or personal injury is then transferred to the operator:

- The device is not used in accordance with the operating manual.
- The device is used outside of its intended use.
- The device is used with accessories or consumables which are not recommended by Eppendorf.
- The device is maintained or repaired by people not authorized by Eppendorf.
- The user makes unauthorized changes to the device.

3.5 Warnings for intended use

Read the operating manual and observe the following general safety instructions before using the Centrifuge 5804/5804 R/5810/5810 R.

3.5.1 Personal injury or damage to the equipment



WARNING! Electric shock due to damage to device or mains cable.

- ▶ Only switch on the device if the device and mains cable are undamaged.
- ▶ Only use devices that have been properly installed or repaired.
- ▶ In case of danger, disconnect the device from the mains supply by pulling the power plug from the device or the mains socket or, by using the isolating device intended for this purpose (e.g., emergency stop switch in the laboratory).



WARNING! Lethal voltages inside the device.

Touching parts which are under high voltage may cause an electric shock. An electric shock injures the heart and causes respiratory paralysis.

- ▶ Ensure that the housing is closed and undamaged.
- ▶ Do not remove the housing.
- ▶ Ensure that no liquid can penetrate into the device.

Only authorized service staff may open the device.



WARNING! Risk from incorrect supply voltage

- ▶ Only connect the device to voltage sources which correspond to the electrical requirements on the name plate.
- ▶ Only use sockets with a protective earth (PE) conductor and suitable power cable.



WARNING! Damage to health due to infectious liquids and pathogenic germs.

- ▶ When handling infectious liquids and pathogenic germs, observe the national regulations, the biological security level of your laboratory, the material safety data sheets, and the manufacturer's application notes.
- ▶ Use aerosol tight sealing systems for the centrifugation of these substances.
- ▶ When working with pathogenic germs belonging to a higher risk group, more than one aerosol-tight bioseal must be used.
- ▶ Wear personal protective equipment.
- ▶ For comprehensive regulations about handling germs or biological material of risk group II or higher, please refer to the "Laboratory Biosafety Manual" (source: World Health Organization, Laboratory Biosafety Manual, in its respectively current valid version).



WARNING! Risk of injury when opening or closing the centrifuge lid.

There is a risk of crushing your fingers when opening or closing the centrifuge lid.

- ▶ When opening or closing the centrifuge lid, do not reach between the lid and device or into the latching mechanism of the lid.
- ▶ Always open the centrifuge lid completely to prevent it from falling.



WARNING! Risk of injury due to defective gas spring(s).

A defective gas spring is an insufficient support for the centrifuge lid. There is a risk of crushing fingers or limbs.

- ▶ Make sure that the centrifuge lid can be opened completely and that it will remain in this position.
- ▶ Regularly check all gas springs for their proper function.
- ▶ Have defective gas springs replaced immediately.
- ▶ Have gas springs replaced by a service technician every 2 years.



CAUTION! Poor safety due to incorrect accessories and spare parts.

The use of accessories and spare parts other than those recommended by Eppendorf may impair the safety, functioning and precision of the device. Eppendorf cannot be held liable or accept any liability for damage resulting from the use of incorrect or non-recommended accessories and spare parts, or from the improper use of such equipment.

- ▶ Only use accessories and original spare parts recommended by Eppendorf.



NOTICE! Damage to device due to spilled liquids.

1. Switch off the device.
2. Disconnect the device from the power supply.
3. Carefully clean the device and the accessories in accordance with the cleaning and disinfection instructions in the operating manual.
4. If a different cleaning and disinfecting method is to be used, contact Eppendorf AG to ensure that the intended method will not damage the device.



NOTICE! Damage to electronic components due to condensation.

Condensate can form in the device after it has been moved from a cool environment to a warmer environment.

- ▶ After installing the device, wait at least for 4 h. Only then connect the device to the mains.



NOTICE! Buckets swinging out in the wrong direction.

When working with the rotor S-4-104, using the wrong adapters with 500 mL Corning tubes may lead to the loss of samples or damage to the centrifuge.

- ▶ Only use the Eppendorf adapter intended for this purpose.

3.5.2 Incorrect handling of the centrifuge

**NOTICE! Damage from knocking against or moving the device during operation.**

If the rotor bangs against the rotor chamber wall, it will cause considerable damage to the device and rotor.

- ▶ Do not move or knock against the device during operation.
-

3.5.3 Incorrect handling of the rotors

**WARNING! Risk of injury from improperly attached rotors and rotor lids.**

- ▶ Only centrifuge with rotor and rotor lid firmly tightened.
 - ▶ If unusual noises occur when the centrifuge starts, the rotor or the rotor lid may not be properly secured. Immediately press the **start/stop** key to stop centrifuging.
-

**CAUTION! Risk of injury due to asymmetric loading of a rotor.**

- ▶ Load rotors symmetrically with identical tubes or plates and buckets.
 - ▶ Always load all positions of a swing-bucket rotor with buckets.
 - ▶ Only load adapters with suitable tubes or plates.
 - ▶ Always use tubes or plates of the same type (weight, material/density and volume).
 - ▶ Check that loading is symmetrical by balancing the adapters and tubes or plates used with scales.
-

**CAUTION! Risk of injury from overloaded rotor.**

The centrifuge is designed for the centrifugation of material with a maximum density of 1.2 g/mL at maximum speed and filling volume and/or load.

- ▶ Do not exceed the maximum load of the rotor.
-

**NOTICE! Damage to rotors from aggressive chemicals.**

Rotors are high-quality components which withstand extreme stresses. This stability can be impaired by aggressive chemicals.

- ▶ Avoid using aggressive chemicals, including strong and weak alkalis, strong acids, solutions with mercury, copper and other heavy metal ions, halogenated hydrocarbons, concentrated saline solutions and phenol.
- ▶ If the rotor is contaminated by aggressive chemicals, clean it immediately using a neutral cleaning agent. This applies to the rotor bores, in particular.
- ▶ Due to the manufacturing process, color variations may occur on rotors marked "coated". These color variations do not effect service life or resistance to chemicals.



NOTICE! If handled incorrectly, the rotor can fall over.

The swing-bucket rotor may fall if the buckets are used as handles.

- ▶ Remove the buckets before inserting and/or removing a swing-bucket rotor.
- ▶ Always use both hands to carry the rotor cross.



NOTICE! If handled incorrectly, the rotor can fall over.

- ▶ Always pick up the rotor F-35-48-17 with both hands.
- ▶ In order to hold the rotor safely, possibly you have to remove 3 to 4 sleeves from the opposite outer row.



CAUTION! Risk of injury due to chemically damaged rotor lids or caps.

Transparent rotor lids or caps made from PC, PP or PEI may lose their strength under the impact of organic solvents (e.g., phenol, chloroform).

- ▶ If rotor lids or caps have come into contact with organic solvents, they should be cleaned immediately.
- ▶ Regularly check the rotor lids and caps for damages and cracks.
- ▶ Immediately replace rotor lids or caps that have cracks or milky stains.

3.5.4 Extreme strain on the centrifuging tubes



CAUTION! Risk of injury from overloaded tubes.

- ▶ Note the loading limits specified by the tube manufacturer.
- ▶ Only use tubes which are approved by the manufacturer for the required rcf.



NOTICE! Risk from damaged tubes.

Damaged tubes must not be used, as this could cause further damage to the device and the accessories and loss of the samples.

- ▶ Before use, visually check all of the tubes for damage.



NOTICE! Risk from open tube lids.

Open tube lids can brake off during centrifugation and damage the rotor and the centrifuge.

- ▶ Carefully seal all tube lids before centrifuging.

**NOTICE! Hazard to plastic tubes from organic solvents.**

The density of plastic tubes is reduced when organic solvents (e.g., phenol, chloroform) are used, i.e. the tubes could become damaged.

- ▶ Observe the manufacturer's specifications for chemical resistance of the tubes.

**NOTICE! Micro test tubes heat up.**

In uncooled centrifuges, the temperature in the rotor chamber, rotor and sample can increase to above 40 °C, based on the run time, g-force (rcf)/speed and ambient temperature.

- ▶ Please note that this will reduce the resistance to centrifugation of the micro test tubes.
 - ▶ Please note the temperature resistance of the samples.
-

3.5.5 Aerosol-tight centrifugation

**WARNING! Risk to health due to limited aerosol tightness with incorrect rotor/rotor lid combination.**

Aerosol-tight centrifugation is guaranteed only if the rotors and rotor lids intended for this purpose are used. The designation of aerosol-tight fixed-angle rotors always starts with **FA**. The aerosol-tight rotors and rotor lids of this centrifuge are additionally marked with a red ring on the rotor and a red rotor lid screw.

Aerosol-tight swing-bucket rotors are marked **AT** (aerosol-tight).



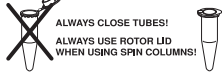
- ▶ For aerosol-tight centrifugation, always simultaneously use rotors and rotor lids which are marked as aerosol-tight in the centrifuge intended for the corresponding purpose. The details specifying in which centrifuge you may use the aerosol-tight rotors and rotor lids can be found on the rotor and, beginning from production date of October 2003, on the upper side of the rotor lid.
- ▶ Only use aerosol-tight rotor lids in combination with rotors which are marked on the rotor lid.
- ▶ Only use aerosol-tight buckets with the corresponding caps.

**WARNING! Damage to health as a result of limited aerosol tightness and incorrect usage.**

Autoclaving, mechanical stresses and contamination by chemicals or other aggressive solvents can impair the aerosol-tightness of the rotors and rotor lids.

- ▶ Check the integrity of the seals of the aerosol-tight rotor lids or caps before each use.
 - ▶ Only use aerosol-tight rotor lids or caps if the seals are undamaged and clean.
 - ▶ Lightly grease the threads of the rotor lid screw with pivot grease after every proper autoclaving (121 °C, 20 min.). (Order no. Int. 5810 350.050, North America 022634330).
 - ▶ Replace aerosol-tight rotor lids and caps after 50 autoclaving cycles.
 - ▶ For QuickLock rotor lids, the seal must be replaced after 50 autoclaving cycles.
 - ▶ **Never** store aerosol-tight rotors or buckets closed.
-

3.6 Safety instructions located on the device

Display	Meaning	Location
	Follow the instructions in the operating manual.	Right side of the device
	CAUTION Always tighten the rotor using the supplied rotor key.	Top of device, below the centrifuge lid
	CAUTION Close all tubes and use a rotor lid.	Top of device, below the centrifuge lid

Safety

Centrifuge 5804/5804 R/5810/5810 R
English (EN)

4 Installation

4.1 Selecting the location



NOTICE! If an error occurs, the objects in the immediate proximity of the device will be damaged.

- ▶ In accordance with the recommendations of EN 61010-2-020, leave a safety clearance of **30 cm** around the device during operation.
- ▶ Please remove all materials and objects from this area.



NOTICE! Damage from overheating.

- ▶ Do not install the device near to any heat sources (e.g., heating, drying cabinet).
- ▶ Do not expose the device to direct sunlight.
- ▶ Ensure unobstructed air circulation. Keep free a clearance of at least 30 cm around all ventilation grilles.



NOTICE! Radio interference.

This device is a category A product in accordance with EN 55011. There may be disturbance to radio reception in residential areas.

- ▶ Ensure that appropriate preventive measures are taken.
-

Select the location for the device according to the following criteria:

- Suitable power connection as per the name plate (230 V/120 V/100 V).
- Stable, horizontal and resonance-free lab bench.
- A well ventilated environment which is protected from direct sunlight to prevent the device from heating up more.

4.2 Preparing installation



CAUTION! Risk of injury when lifting and carrying heavy loads

The device is heavy. Lifting and carrying the device can lead to back injuries.

- ▶ Only lift and transport the device with a sufficient number of helpers.
 - ▶ Use a transport aid for transporting the device.
-

Perform the following steps in the sequence described.

1. Open the box.
2. Remove the covering cardboard.
3. Remove the accessories.
4. Lift the device by the underside in the vicinity of the device feet and place it directly on a suitable lab bench.

Installation

Centrifuge 5804/5804 R/5810/5810 R
English (EN)

4.3 Installing the instrument

**WARNING! Risk from incorrect supply voltage**

- ▶ Only connect the device to voltage sources which correspond to the electrical requirements on the name plate.
 - ▶ Only use sockets with a protective earth (PE) conductor and suitable power cable.
-

**NOTICE! Centrifuge 5804 R/5810 R: compressor damage after improper transport.**

- ▶ Only switch on the centrifuge 4 hours after installation.
-

Perform the following steps in the sequence described.

1. Allow the device to warm up for at least 3 hours (5804/5810) or 4 hours (5804 R/5810 R) to the ambient temperature to prevent damage to the electronic components from condensation and damage to the compressor (only 5804 R/5810 R).
2. Check that the mains voltage and frequency match the requirements on the device type plate.
Centrifuge 5804 R/5810 R with power supply voltage 120 V: See also the notes on the power supply at the end of this chapter.
3. Connect the centrifuge to the mains and switch it on using the mains power switch on the right side of the device.
 - The key **open** lights up.
 - Display is illuminated.
4. Open the centrifuge lid using the **open** key.
5. Use the details included in the scope of delivery to check that the delivery is complete (see *Delivery package on p. 9*).
6. Check all parts for any transport damage. Contact your dealer if any damage is found.
7. **Only 5804 R/5810 R:** Insert the condensation water tray at the front of the device into the provided holder

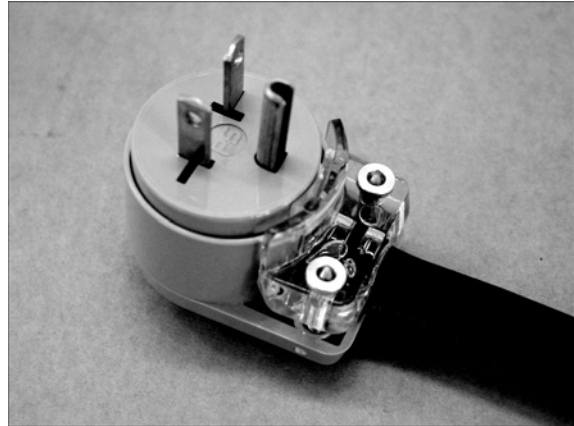
Tab. 4-1: Centrifuge 5804 R / 5810 R with mains voltage 120 V in two versions

15 A IEC power cable



- Conventional IEC power cable.
- Connection to standard socket (120 V/15 A).
- Standard cooling performance:
 - Increased minimum achievable temperatures at maximum speed of centrifugation.
 - Slower cooling down to set temperature.

20 A variant



- Power cable fitted permanently to the device.
- Special mains connection required (120 V/20 A).
- Increased cooling performance.
 - Lower temperatures at maximum speed of centrifugation possible.
 - Quicker cooling down to set temperature.

Installation

Centrifuge 5804/5804 R/5810/5810 R
English (EN)

5 Operation

5.1 Overview of operating controls

Before using the centrifuge for the first time, familiarize yourself with the operating controls and the display.

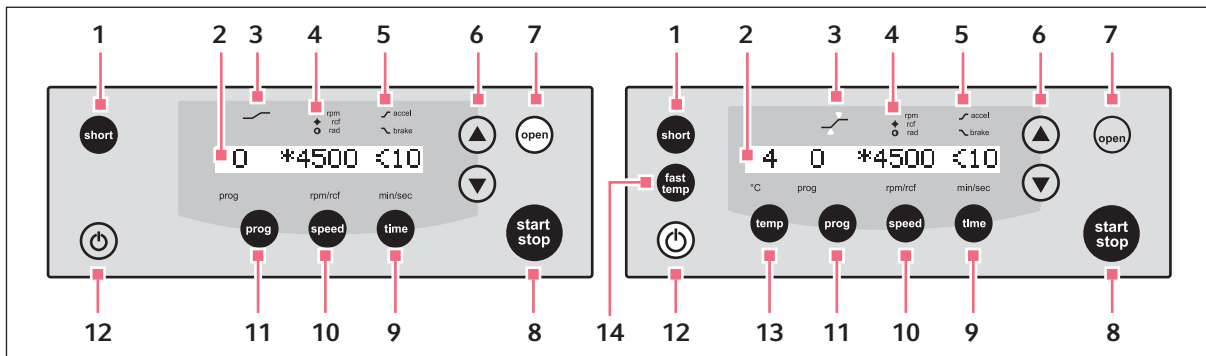


Fig. 5-1: Control panel of the Centrifuge 5804/5810 and the Centrifuge 5804 R/5810 R.

- | | |
|--|---|
| <ul style="list-style-type: none"> 1 Short spin centrifugation 2 Display 3 Status At set rpm function
 <ul style="list-style-type: none"> ↗: Start of run time when reaching 95% of the preset g-force (rcf) or speed (rpm). ↘: Start of run time immediately. 4 Indicate speed (rpm), g-force (rcf) * and radius setting ⓪. 5 Symbol for acceleration ↗ and braking ↘ 6 Set parameters and values. 7 Release centrifuge lid. | <ul style="list-style-type: none"> 8 Start or stop centrifugation. 9 Adjust centrifugation time. 10 Set centrifugation speed. 11 Select or save program. 12 Standby 13 Only 5804 R/5810 R: Set the temperature. 14 Only 5804 R/5810 R: Start temperature control run FastTemp. |
|--|---|

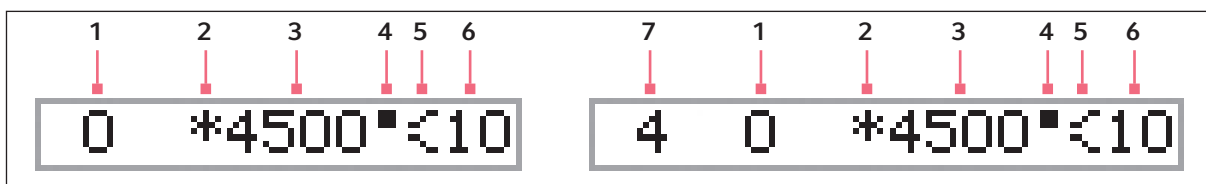


Fig. 5-2: Display of Centrifuge 5804/5810 and the Centrifuge 5804 R/5810 R

- | | |
|--|---|
| <ul style="list-style-type: none"> 1 Program number 2 Symbol for g-force (rcf) 3 g-force (rcf)/rotational speed (rpm) 4 Symbol flashes during centrifugation | <ul style="list-style-type: none"> 5 Symbol for acceleration ↗ and braking ↘ 6 Centrifugation time 7 Only 5804 R/5810 R: Temperature |
|--|---|

Operation

Centrifuge 5804/5804 R/5810/5810 R
English (EN)

The display of the centrifugation parameters changes depending upon the condition of the device:


- Rotor stop: display of set values.
- Centrifugation: display of actual values.

When you press the **temp**, **time** or **speed** keys during centrifugation, the respective set value is displayed for 2.5 seconds.

Please also read the precise description of the individual functions (see p. 71).

5.2 Preparing for centrifugation

5.2.1 Switching on the centrifuge

1. Switch on the centrifuge using the mains power switch or the  standby key.
2. Open the closed centrifuge lid by pressing the **open** key.
The parameter settings of the last run are displayed.

5.2.2 Inserting the rotor

Prerequisites

When attaching the rotor to or releasing it from the motor shaft, the temperature of the rotor and motor shaft must be within the range of 10 – 30°C.



NOTICE! If handled incorrectly, the rotor can fall over.

- ▶ Always pick up the rotor F-35-48-17 with both hands.
- ▶ In order to hold the rotor safely, possibly you have to remove 3 to 4 sleeves from the opposite outer row.



- ▶ **Swing-bucket rotors:** remove the buckets before inserting and/or removing the rotor. Use both hands to pick up the rotor cross.

1. Fit the rotor vertically on the motor shaft.
2. Insert the supplied rotor key into the rotor nut.
Rotor cross A-4-81/S-4-104: Use the special rotor key.
3. Turn rotor key **clockwise** until the rotor nut is firmly tightened.

5.2.3 Automatic rotor detection

The centrifuge has automatic rotor detection. It detects a newly inserted rotor and displays its maximum permitted speed for approx. 2 s. g-force (rcf) and speed (rpm) are automatically limited to the maximum permitted value for the rotor.

In order to trigger the rotor detection,

- ▶ press and hold the **start/stop** key with the centrifuge lid open and turn the rotor counterclockwise by hand.

The display shows the maximum permitted speed for the rotor. g-force (rcf) and speed (rpm) are automatically limited to the maximum permitted value for the rotor.

- ▶ Check the **At set rpm** setting.



Rotor detection can also be triggered by short spin centrifugation:

- ▶ Press the short key until the maximum permitted speed for the rotor appears in the display.



If a centrifugation is started right after a rotor change, the centrifuge has not conducted an automatic rotor detection. The speed set for the previous rotor may exceed the maximum permitted speed for the new rotor. In this case, the centrifuge stops after the automatic rotor detection and displays *SPEED*. The new maximum permitted speed appears in the display. Only select programs only after the automatic rotor detection.

You can then restart the centrifuging with these settings or adjust the speed as necessary.

- ▶ After each rotor change, check whether the new rotor is detected by the device.
- ▶ Check the set g-force (rcf) or speed (rpm) and adjust it if necessary.

5.2.4 Loading the rotor



CAUTION! Risk of injury due to asymmetric loading of a rotor.

- ▶ Load rotors symmetrically with identical tubes or plates and buckets.
- ▶ Always load all positions of a swing-bucket rotor with buckets.
- ▶ Only load adapters with suitable tubes or plates.
- ▶ Always use tubes or plates of the same type (weight, material/density and volume).
- ▶ Check that loading is symmetrical by balancing the adapters and tubes or plates used with scales.



CAUTION! Risk from damaged or overloaded tubes.

- ▶ When loading the rotor, observe the safety precautions on dangers as a result of overloaded or damaged tubes (see *Warnings for intended use on p. 46*).



The device automatically detects imbalances during operation and stops the run immediately with an error message and a signal tone.

- ▶ Check the load, balance the tubes and restart the run.

Operation

Centrifuge 5804/5804 R/5810/5810 R
English (EN)

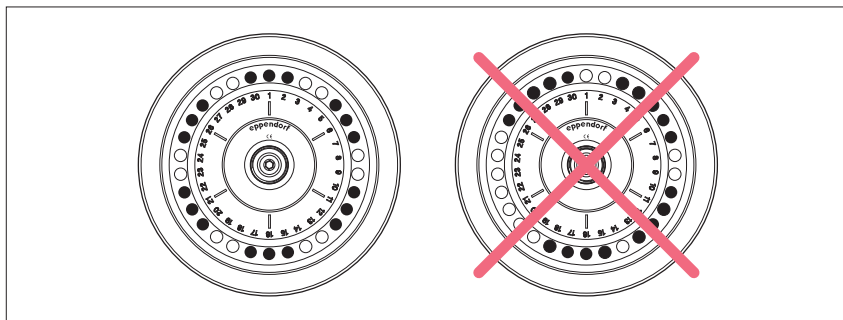
5.2.4.1 Fixed-angle rotors

**Rotor lid**

- Fixed-angle rotors may only be operated with the appropriate rotor lid in each case. This is clearly shown by the identical rotor name labeling on the rotor and on the rotor lid.
- To carry out an aerosol-tight centrifugation, an aerosol-tight rotor must be used in combination with the corresponding rotor lid or cap.

To load the rotor, proceed as follows:

1. Check the maximum load (adapter, tube and contents) per rotor bore.
The information about this can be found on the rotor and in this operating manual (see *Rotors on p. 11*).
2. Load rotors and adapters only with the tubes intended for them.
3. Insert tubes opposite each other in pairs into the rotor bores. For symmetric loading, tubes that face each other must be the same type and have the same filling quantity.



To keep the weight differences between the filled tubes low, we recommend taring with a balance. This will reduce wear on the drive and reduce operating noise.

4. Attach and tighten the rotor lid.

5.2.4.2 Swing-bucket rotors

Prerequisites

- A rotor, bucket and adapter combination approved by Eppendorf.
- The buckets are sorted according to the weight class. Opposite-facing buckets must have the same weight class, which is imprinted in the groove: e.g., 68 (the last 2 positions in grams). Please specify the corresponding weight class for reorders - including plate buckets.
- Matching and tested tubes and plates.
- Do not remove the middle guiding elements of the modular adapters of the rectangular buckets in order, e.g., to increase capacity through multi-level centrifugation.



NOTICE! Damage to adapters due to incorrect stacking.

- ▶ Stack the adapters in rectangular buckets in a closed row only from the bottom of the bucket. Do not leave any gaps between the modules.



NOTICE! Filling the plates too high can cause overflowing.

During the run the meniscuses in the tubes along the edges of the plates are at an angle. This is due to the centrifugal forces and cannot be avoided.

- ▶ Fill the plate wells to a maximum of 2/3 of the maximum filling volume.

To load the rotor, proceed as follows:

1. Check the bucket grooves for cleanliness and lightly grease them with pivot grease (int. order no.: 5810 350.050/North America: 022634330).

Contaminated grooves and pegs impede the even swinging of the buckets.

2. Hang the buckets into the rotor.
All rotor positions must be equipped with buckets.
3. Check to see if all buckets are completely hung and can freely swing out.

Ensure that everything can swing freely

4. To check whether bottles, plates or tubes can swing freely, swing buckets manually.

Check swinging direction

5. To check whether the buckets including their load swing with the floor in the direction of the rotor chamber wall, start turning the rotor cross anti-clockwise.
6. Check the maximum load per carrier (adapter, tube or plate and contents) and the loading height.
The information about this can be found on the rotor and in this operating manual (see *Rotors on p. 11*).
7. Load the buckets symmetrically.

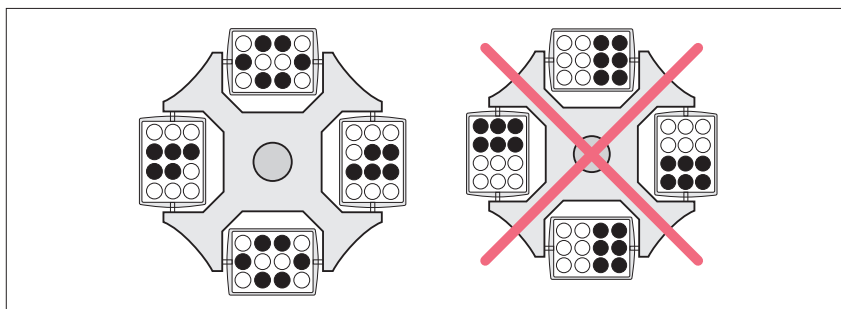


Fig. 5-3: Incomplete, but symmetric loading of the buckets. The pegs of each bucket must be evenly loaded.

Operation

Centrifuge 5804/5804 R/5810/5810 R
English (EN)

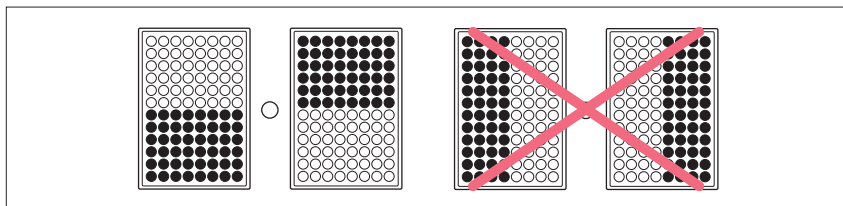


Fig. 5-4: Symmetrical loading of the plates.

The plate charging shown on the right side is incorrect because the bucket cannot correctly swing out. The same principle also applies to the loading of rotor A-4-81-MTP/Flex with 4 plates. The plates have a small amount of play in the buckets.

8. Check the loading of the bucket.

5.2.4.3 Rotor S-4x750: Equipping the adapter with vessels > 119 mm



NOTICE! Broken glass due to incorrect loading.

If the tubes in a bucket are too long, the swinging tubes will touch the rotor cross and may get damaged or destroyed.

- ▶ Load buckets such that they can swing out freely.
- ▶ If necessary, load only the inner bores of the adapter.
- ▶ If using tubes which are longer than 100 mm, always perform a manual swing-out test.

If the adapter 16 × 75 mm – 100 mm (order number 5825 736.001) is equipped with vessels > 119 mm in length, e.g., BD 8 mL Vacutainer, there is a risk of glass breakage.

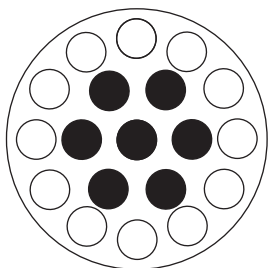


Fig. 5-5: Loading the adapter 16 × 75 - 100 mm with vessels >119 mm in length.

- ▶ Only load the inner bores.

5.2.4.4 Mixed loading with buckets and plate carriers

Mixed loading of swing-bucket rotors with buckets and plate carriers is possible if these are intended for the rotor. Buckets or plate carriers which are opposite each other must be buckets/plate carriers of the same type.

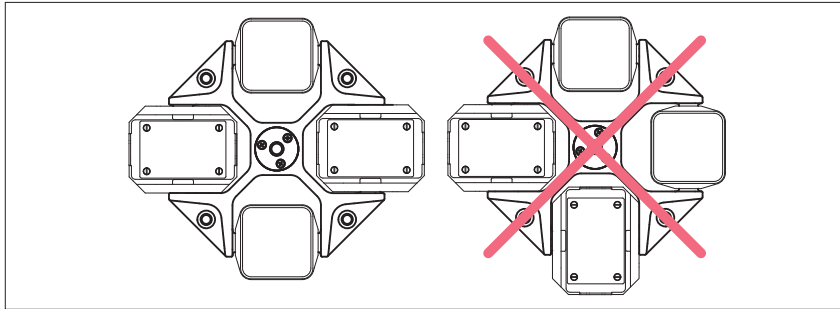


Fig. 5-6: Mixed loading of rotors

Rotor	Mixed loading
S-4-104	<ul style="list-style-type: none"> • 2 plate buckets (open bucket or plate bucket) • 2 round buckets
A-4-81/A-4-81-MTP/Flex	<ul style="list-style-type: none"> • 2 plate buckets (MTP or DWP bucket) • 2 buckets for conical tubes • 2 rectangular buckets
A-4-44	<ul style="list-style-type: none"> • 2 rectangular buckets • 2 buckets for conical tubes



NOTICE! Rotor damage due to mixed loading.

If you load the rotors A-4-62 and A-4-62-MTP with a mixed equipment, the rotors are damaged during centrifugation.

- ▶ Load all positions of the rotors A-4-62 and A-4-62-MTP with the same buckets.
- ▶ Always load all 4 positions of the swing-bucket rotors.

- ▶ Check the loading of the bucket.

5.2.5 Closing the centrifuge lid



WARNING! Risk of injury when opening or closing the centrifuge lid.

There is a risk of crushing your fingers when opening or closing the centrifuge lid.

- ▶ When opening or closing the centrifuge lid, do not reach between the lid and device or into the latching mechanism of the lid.
- ▶ Always open the centrifuge lid completely to prevent it from falling.

1. Check the correct attachment of the rotor and rotor lid.
2. Push down the centrifuge lid until the lid latch engages and the lid is automatically closed.

The centrifuge will close automatically.

The **open** key lights up blue. The ■ symbol appears in the display.

Operation

Centrifuge 5804/5804 R/5810/5810 R
English (EN)

5.3 Cooling (only 5804 R/5810 R)

5.3.1 Temperature adjustment

- ▶ Select the temperature setting using the **temp** key.
- ▶ Set the temperature using the arrow keys between -9°C and +40°C.

5.3.2 Temperature display

If the rotor is stopped: Target temperature
During centrifugation: Actual temperature

5.3.3 Temperature monitoring

After the target temperature has been reached, the centrifuge reacts to temperature deviations during centrifugation as follows:

Deviation from set value	Action
± 3 °C	Temperatures on the display are flashing.
± 5 °C	Periodic warning tone. Centrifugation is stopped automatically.

5.3.4 FastTemp

This function can be used to start a temperature control run directly without samples with a rotor and temperature-specific speed in order to quickly adjust the rotor chamber, including the rotor, buckets and adapters, to the previously set nominal temperature.

Prerequisites

- The centrifuge is switched on.
- The rotor and rotor lid are properly attached.
- The centrifuge lid is closed.
- Temperature and g-force (rcf)/speed (rpm) for the centrifugation are set (see *Centrifuging on p. 66*).

1. Press the **fast temp** key.

The display shows from left to right: actual temperature value, *FT*, g-force (rcf)/speed (rpm) and -- (time).

The temperature control run automatically ends when the set temperature is reached. A periodic signal tone sounds.

2. Press the **start/stop** key to terminate the temperature control run early.

After the set temperature has been reached and the temperature control run is complete, the centrifuge keeps the rotor chamber with the centrifuge lid closed at the set target temperature if the temperature is below the ambient temperature. However, independent of the target temperature, 4 °C must be met via this continuous cooling in order to prevent the rotor chamber from freezing.



The centrifuge stops the cycle automatically if the rotor or the buckets have reached the set temperature. Therefore, there may be a delay of approx. 30 min between the display of the set temperature and the automatic end of the temperature control run.



When using aerosol-tight buckets, always carry out a FastTemp run at low temperatures without a cap. There is a danger otherwise of the caps becoming fixed by suction due to a vacuum. Do not pull on the sealing clamps or hooks to loosen the cap. Adjust the temperature of the buckets to room temperature so that the caps can be removed easily.

5.3.5 Continuous cooling

If the rotor stops, the rotor chamber will be maintained at the target temperature if the following requirements have been met:

- The centrifuge is switched on.
- The centrifuge lid is closed.
- The target temperature is lower than the ambient temperature.
- The centrifuge is not in standby mode.

During continuous cooling the following applies:

- The set and actual temperature are displayed alternately.
- Irrespective of the set temperature, the temperature does not go below 4 °C to prevent the rotor chamber from freezing and from increased condensation in the device.
- The temperature adjustment is slower because the rotor does not rotate during this process.

To end continuous cooling, open the centrifuge lid or press the standby key.

If the centrifuge is not used for more than 8 hours, the continuous cooling is switched off automatically (ECO shut-off). The device then switches to standby mode. This protects against ice formation in the rotor chamber and increased condensation in the device. With **FastTemp** you can quickly reach the desired temperature again (see p. 64).

You can also change from automatically switching off continuous cooling after 8 hours (ECO shut-off) to unlimited continuous cooling.



NOTICE! Ice formation and compressor overheating during continuous cooling.

- ▶ Switch the centrifuge off regularly to eliminate any ice formation by thawing.
- ▶ Regularly remove condensation from the rotor chamber using a soft, absorbent cloth.
- ▶ Empty and clean the condensation water tray regularly.

1. When the centrifuge lid is opened, press the **temp** and **prog** keys simultaneously.
Standby 8h appears in the display.
2. Press the **fast temp** key immediately.
Endless operation for continuous cooling is activated. *Standby endless* appears in the display.
3. To change back to *Standby 8h*, repeat the process.

5.4 Centrifuging



CAUTION! Risk from incorrectly loaded rotors and damaged/overloaded tubes!

- ▶ Before commencing centrifugation, follow the safety instructions relating to risks from asymmetrically loaded and/or overloaded rotors and from overloaded, damaged and/or open tubes (see *Warnings for intended use on p. 46*).







WARNING! Risk of injury from improperly attached rotors, rotor lids and caps.

- ▶ Only centrifuge with firmly tightened rotor and rotor lid as well as with inserted carriers, buckets and correctly closed caps.
- ▶ If unusual noises occur when the centrifuge starts, the rotor, the rotor lid or a cap may not be properly secured. Immediately press the **start/stop** key to stop centrifuging.

Each of the centrifuging variants described here must be preceded by the preparation described above (see *Preparing for centrifugation on p. 58*).

5.4.1 Centrifugation with time setting

Perform the following steps in the sequence described.

- 
 1. Speed (rpm) setting: press once. g-force (rcf) setting: press repeatedly until the symbol * additionally appears in the display.
The displayed g-force (rcf)/speed (rpm) flashes and can be set with the arrow keys.
For the g-force (rcf) setting also check the set radius (see *Rotors on p. 11*), (see *Setting the radius on p. 71*).
- 
 2. Use the arrow keys to set the g-force (rcf)/speed (rpm).
The new set value appears in the display.
- 
 3. Select the runtime setting and set it with the arrow keys.
- 
 4. **Only 5804 R/5810 R:** Select the temperature setting and set it with the arrow keys.



5. Start centrifugation.

- ■ blinks in the display when the rotor is running.
- **Only 5804 R/5810 R:** The current temperature will be displayed.
- The current g-force (rcf)/speed (rpm) of the rotor is displayed.
- You can display all set values for 2.5 s by pressing a parameter key (**Temp, Speed, Time**).
- You can terminate centrifugation early by pressing the **start/stop** key.
- The centrifuge automatically stops after the set time has elapsed.
- The elapsed centrifugation will be shown in a blinking display during the braking process.



6. Open the centrifuge lid as soon as the key lights up.



During the run you can modify the total run time, the temperature (only Centrifuge 5804 R/ 5810 R) and the g-force (rcf)/speed (rpm) as well as the acceleration time and the braking time. The new parameters are adopted immediately. The time which has already elapsed is considered in the newly set total run time. Please note that the shortest new total run time that can be set is the elapsed time plus 2 minutes.

5.4.2 Centrifuging in continuous operation

Perform the following steps in the sequence described.

1. Set the g-force (rcf)/speed (rpm) and possibly the temperature as previously described (see p. 66).



2. Select the runtime setting.



3. Set continuous operation below 1 min or above 99 min.
In the display ∞ indicates continuous run.



4. Start centrifugation.

- ■ blinks in the display when the rotor is running.
- If the centrifuge runs for more than 99 min, 99. appears in the display.
- **Only 5804 R/5810 R:** The current temperature will be displayed.
- The current g-force (rcf)/speed (rpm) of the rotor is displayed.



5. End centrifugation after the desired time.

- The elapsed centrifugation will be shown in a blinking display during the braking process.



6. Open the centrifuge lid as soon as the key lights up.



Operation

Centrifuge 5804/5804 R/5810/5810 R
English (EN)





5.4.3 Short spin centrifugation

You can carry out a short spin centrifugation with the currently set or with the maximum g-force (rcf)/speed (rpm) of the used rotor.

5.4.3.1 Setting the speed option

- 
 - ▶ Press and hold down the key with the centrifuge lid open. One of the following options appears in the display:
 - rpm max*: the rotor accelerates up to its maximum g-force (rcf)/speed (rpm) (see *Rotors on p. 11*).
 - 200 - rpm*: the rotor only accelerates up to its set g-force (rcf)/speed (rpm).
- 
 - ▶ Press and hold down the key for more than 3 s with the centrifuge lid open to switch between the *rpm max* and *200 - rpm* options. The selected option appears in the display for 2 s and is retained.

5.4.3.2 Starting the short spin centrifugation

1. If *200 - rpm* is set, set the g-force (rcf)/ speed (rpm) for the short spin centrifugation (see p. 66).
2. **Only 5804 R/5810 R:** set temperature (see p. 66).
- 
 - 3. Keep the key pressed to start the short spin centrifugation.
 - *SH* appears in the display while the rotor is running.
 - The time is counted upwards in seconds.
- 
 - 4. Release to end the short spin centrifugation.
- 
 - During the braking process, you can restart the centrifugation up to two times by pressing the **short** key again.
- 
 - 5. Open the centrifuge lid as soon as the key is illuminated.

5.4.4 Removing the rotor

Prerequisites

When attaching the rotor to or releasing it from the motor shaft, the temperature of the rotor and motor shaft must be within the range of 10 – 30°C.



NOTICE! If handled incorrectly, the rotor can fall over.

The swing-bucket rotor may fall if the buckets are used as handles.

- ▶ Remove the buckets before inserting and/or removing a swing-bucket rotor.
- ▶ Always use both hands to carry the rotor cross.



NOTICE! If handled incorrectly, the rotor can fall over.

- ▶ Always pick up the rotor F-35-48-17 with both hands.
- ▶ In order to hold the rotor safely, possibly you have to remove 3 to 4 sleeves from the opposite outer row.

-
1. Turn the rotor nut **counterclockwise** using the rotor key.
 2. Remove the rotor by lifting it vertically.
 3. **Only 5804 R/5810 R:** Switch off the centrifuge after use and empty the condensation water tray. Leave centrifuge lid fully opened and protect it against closing.

5.4.5 Standby mode

- ▶ You can switch between standby mode and ready state at any time when centrifugation is not performed by pressing the standby key.

Standby mode

- The display expires.
- The standby key lights red.
- **Only 5804 R/5810 R:** The rotor chamber is not cooled (see *Continuous cooling on p. 65*).

Ready state

- The centrifugation parameters are displayed.
- The standby key lights up in green.
- **Only 5804 R/5810 R:** The rotor chamber is cooled when the centrifuge lid is closed (see *Continuous cooling on p. 65*).





Operation

Centrifuge 5804/5804 R/5810/5810 R
English (EN)

6 Operating controls and function







6.1 Setting the radius



When you control the rotational speed via the g -force (rcf, RCF), and not via the speed (rpm), the internal conversion of speed to g -force takes place by default with the largest radius of the used rotor. (See *Rotors on p. 11*). You can adapt this radius to an applied adapter:

-  1. Press several times until the symbol  also appears in the display.
The current radius flashes.
-  2. Set the new radius.
-  3. Wait for 3 seconds (if the rotor is stopped: 10 seconds).
The changed g -force appears.

6.2 Setting the acceleration and braking times

You can set the acceleration and braking time in the levels 0 to 9 (see Tab. on p. 90). Level 9 is preset (shortest acceleration and braking time).

-  1. Press twice until the  symbol for acceleration level (accel) appears in the display.
-  2. Select acceleration level 0 to 9.
-  3. Press once until the  symbol for braking level (brake) appears in the display.
-  4. Select braking level 0 to 9.
Braking level (brake) 0 corresponds to free deceleration.

The device only shows the  and  symbols continually when levels 0 to 8 have been set.

6.3 Setting the start of run time (At set rpm)

The centrifuge can count down the set time either immediately from the start of centrifugation or only once 95% of the specified g -force (rcf)/speed (rpm) has been reached (At set rpm). The respective setting is indicated by the flashing triangle in the symbol above the display:



Preset time: the set time is counted down immediately after the start of centrifugation.



At set rpm: the set time is counted down once 95% of the specified g -force (rcf)/speed (rpm) has been reached.

Prerequisites

The centrifuge lid is open.



- ▶ Hold down this key for at least 4 s to switch between the two settings,





When pressing the key, both triangles of the symbol will flash in turn.

6.4 Saving the program

You can save the current centrifugation parameters and functions (*At set rpm*, acceleration and braking times and radius) under up to 35 program numbers.

Prerequisites





Rotor stop.

1. Check the parameters and functions to be saved.
 -  2. Press key twice.
 The first free program number appears with *P...* in the display.
 -  3. Select the program number (*1...9, A...Z*).
 -  4. Press and hold key for 2 seconds.
ok appears in the display. The current centrifugation parameters and functions are saved under the selected program number.
-  When you want to overwrite a saved program, you have to delete it before saving the new parameters (see *Deleting the program on p. 73*).

6.5 Loading the program

Prerequisites

- Rotor stop.

-  1. Press once.
 Program number flashes:
 - *0*: centrifugation parameters and functions of the last run.
 - *1...9, A...Z*: stored programs.
 -  2. Select the program number.
 -  3. Closed centrifuge lid: centrifugation starts with the loaded centrifugation parameters and functions.
 When the centrifuge lid is open, you can press the **start/stop** key to return to program *0* or exit the programming mode.
-  If you change the centrifugation parameters during a run with a stored program, the centrifuge changes to program *0*. The stored program remains unchanged.
 You can also exit the stored program by loading program *0*.

6.6 Deleting the program

Prerequisites

- Rotor stop.
- The centrifuge lid is open.



1. Press once.
The program number flashes.



2. Select the program number.



3. Within 10 seconds, keep key pressed for 2 seconds
The following text appears in the display: *cleared*.
The selected program is deleted. You can save new centrifugation parameters and functions under this program number.

6.7 Special functions

6.7.1 Display operating hours

Prerequisites

Rotor stop.



- ▶ Press both keys simultaneously.
The previous total run time of the centrifuge (in hours) appears in the display

6.7.2 Switching on/off the warning signal



- ▶ Press both keys simultaneously to change the setting.
Alarm on or *Alarm off* appears in the display after 2 s.

6.7.3 Exiting the service functions



- ▶ Press both keys simultaneously to exit a service program called by mistake.

6.7.4 Controlling the centrifuge via the serial interface (optional)

Optionally, you can also control all centrifuge functions via a serial interface (RS 232 c). For this a retrofit must be carried out by Eppendorf Service. Only devices verified according to IEC 950 must be connected to the serial interface.

7 Maintenance

7.1 Maintenance



WARNING! Risk of injury due to defective gas spring(s).

A defective gas spring is an insufficient support for the centrifuge lid. There is a risk of crushing fingers or limbs.

- ▶ Make sure that the centrifuge lid can be opened completely and that it will remain in this position.
- ▶ Regularly check all gas springs for their proper function.
- ▶ Have defective gas springs replaced immediately.
- ▶ Have gas springs replaced by a service technician every 2 years.

We recommend that the centrifuge with the associated rotors be checked at the latest every 12 months by Technical Service during maintenance. Observe the relevant national regulations.

7.2 Prepare cleaning/disinfection

- ▶ Clean all accessible surfaces of the device and the accessories at least weekly and when contaminated.
- ▶ Clean the rotor regularly. This way the rotor is protected and the durability is prolonged.
- ▶ Furthermore, observe the notes on decontamination (see *Decontamination before shipment on p. 79*) when the device is sent to the authorized Technical Service for repairs.

The procedure described in the following chapter applies to the cleaning as well as to the disinfection or decontamination. The table below describes the steps required on top of this:

Cleaning	Disinfecting/decontamination
<ol style="list-style-type: none"> 1. Use a mild cleaning fluid to clean the accessible surfaces of the device and the accessories. 2. Carry out the cleaning as described in the following chapter. 	<ol style="list-style-type: none"> 1. Choose the disinfection method which corresponds to the legal regulations and guidelines in place for your range of application. For example, use alcohol (ethanol, isopropanol) or alcohol-based disinfectants. 2. Carry out the disinfection or decontamination as described in the following chapter. 3. Then clean the device and the accessories.



If you have any further questions regarding the cleaning and disinfection or decontamination or regarding the cleaning fluid to be used, contact the Eppendorf AG Application Support. The contact details are provided on the back of this manual.

7.3 Cleaning/disinfection

**DANGER! Electric shock as a result of penetration of liquid.**

- ▶ Switch off the device and disconnect the power plug before starting cleaning or disinfection work.
- ▶ Do not allow any liquids to penetrate the inside of the housing.
- ▶ Do not spray clean/spray disinfect the housing.
- ▶ Only plug the device back in if it is completely dry, both inside and outside.

**NOTICE! Damage from the use of aggressive chemicals.**

- ▶ Do not use any aggressive chemicals on the device or its accessories, such as strong and weak bases, strong acids, acetone, formaldehyde, halogenated hydrocarbons or phenol.
- ▶ If the device has been contaminated by aggressive chemicals, immediately clean it by means of a mild cleaning agent.

**NOTICE! Corrosion from aggressive cleaning agents and disinfectants.**

- ▶ Do not use corrosive cleaning agents, aggressive solvents or abrasive polishes.
- ▶ Do not incubate the accessories in aggressive cleaning agents or disinfectants for a longer period of time.

**NOTICE! Damage from UV and other high-energy radiation.**

- ▶ Do not use UV, beta, gamma, or any other high-energy radiation for disinfecting.
- ▶ Avoid storage in areas with strong UV radiation

**Autoclaving**

Except for the rotor crosses A-4-81, S-4-72 and S-4-104, all rotors, rotor lids, buckets, carriers, caps and adapters can be autoclaved (121 °C, 20 min).

After a maximum of 50 autoclaving cycles, the caps and, for QuickLock rotors, the seals must be replaced.

Do not use any stained, porous or otherwise defective seals. Also note the operating manual of the centrifuge and the supplement sheet on aerosol-tight centrifugation delivered together with the aerosol-tight rotors.

The aerosol-tight rotor FA-45-30-11 can be autoclaved at 142°C for 2 hours to destroy prions. In this case note that the rotor lid must be replaced after each autoclaving.



Aerosol tightness

Check that the seals are intact before use.

Only QuickLock rotor lid: Replace the sealing ring in the lid groove when it becomes worn. Replace the rotor lids with screw cap when the sealing rings on the lid screw and in the lid groove become worn.

The sealing rings require regular care to protect the rotors.

Aerosol-tight rotors should never be stored with lids screwed on!

In order to prevent damage, lightly lubricate the lid thread of the aerosol-tight rotors with pivot grease (order no. Int.: 5810 350.050/North America: 022634330).



Swing-bucket rotor

- Before cleaning the rotor, remove old pivot grease from grooves and pivots.
- Make sure that the grooves and pivots are clean. Dirty grooves and pivots prevent carriers from swinging out evenly.
- After cleaning, lubricate the pivots of the rotor and the grooves of the buckets with pivot grease (order no. Int.: 5810 350.050/North America: 022634330) so that the carriers can move freely in a swinging manner.

7.3.1 Cleaning and disinfecting the device

1. Open the lid. Switch off the device with the mains/power switch. Disconnect the power plug from the power supply.
2. Loosen the rotor nut by turning the rotor key **counterclockwise**.
3. Remove the rotor.
4. Clean and disinfect all accessible surfaces of the device, including the power cable, using a damp cloth and the recommended cleaning agents.
5. Thoroughly clean the rubber seal of the rotor chamber with water.
6. Rub the dry rubber seal with glycerine or talcum powder to prevent it from becoming brittle. Other components of the device, such as the lid latch, lid springs, motor shaft and rotor cone, must not be lubricated.
7. Clean the motor shaft with a soft, dry and lint-free cloth. Do not lubricate the motor shaft.
8. Check the motor shaft for damage.
9. Inspect the device for corrosion and damage.
10. Leave the centrifuge lid open when the device is not being used.
11. Only connect the device to the power supply if it is fully dry inside and out.

7.3.2 Cleaning and disinfecting the rotor



After every 200 runs, the centrifuge displays *clean rotor* three times to remind you about the regular rotor cleaning.

1. Inspect the rotor and accessories for damage and corrosion. Do not use any damaged rotors or accessories.
2. Clean and disinfect the rotors and accessories with the recommended cleaning agents.

Maintenance

Centrifuge 5804/5804 R/5810/5810 R
English (EN)

3. Use a bottle brush to clean and disinfect the rotor bores.
4. Rinse the rotors and accessories thoroughly with distilled water. Rinse the rotor bores of fixed-angle rotors particularly thoroughly.



Do not immerse the rotor in liquid as liquid can get trapped inside the cavities.

5. Place rotors and accessories on a cloth to dry. Place fixed-angle rotors with the rotor bores facing downwards to allow the bores to also dry.
6. Clean the rotor cone with a soft, dry and lint-free cloth. Do not lubricate the rotor cone.
7. Inspect the rotor cone for damage.
8. Place the dry rotor onto the motor shaft.
9. Tighten the rotor nut firmly by turning it **clockwise** with the rotor key.
10. Load the fixed-angle rotor with the cleaned adapters or the swing-bucket rotor with the cleaned buckets and adapters, if necessary.
11. Leave the rotor lid open when the rotor is not being used.

7.4 Additional care instructions for refrigerated centrifuges.

- ▶ Empty and clean the condensation water tray regularly and especially after liquid spillage in the rotor chamber. Pull out the condensation water tray at the front right under the device.
- ▶ The condensation water outlet also needs to be cleaned on a regular basis, e.g., using a bottle brush.
- ▶ Regularly free the rotor chamber from ice formations by thawing. To do this, leave the centrifuge lid open or carry out a short temperature control run at approx. 30 °C.
- ▶ Leave the centrifuge lid open when not in use for a long period.
This enables residual moisture to escape. The gas spring is relieved.
- ▶ Wipe up condensate in the rotor chamber. Use a soft absorbent cloth for this.
- ▶ No later than every 6 months, remove any dust deposits from the ventilation slits of the centrifuge using a brush or swab. First switch off the device and remove the power plug.

7.5 Glass breakage

When using glass tubes there is a risk of glass breakage in the rotor chamber. The resulting glass splinters are swirled around in the rotor chamber during centrifugation and have a sandblasting effect on the rotor and accessories. The smallest glass particles become lodged in the rubber parts (e.g., the motor guide, the rotor chamber seal, and the rubber mats of adapters).



NOTICE! Glass breakage in the rotor chamber

Glass tubes in the rotor chamber may break if the g -force is too high. Broken glass can damage the rotor, accessories and samples.

- ▶ Please note the manufacturer's information on the recommended centrifugation parameters (load and speed).
-

Effects of glass breakage in the rotor chamber:

- Fine black metal abrasion in the rotor chamber (in metal rotor chambers)
- The surfaces of the rotor chamber and accessories are scratched.
- The chemical resistance of the rotor chamber is reduced.
- Contamination of samples
- Wear on rubber parts

How to proceed in case of glass breakage

1. Remove all splinters and glass powder from the rotor chamber and accessories.
2. Thoroughly clean the rotor and rotor chamber. Thoroughly clean the bores of the fixed-angle rotors, in particular.
3. If required, replace the rubber mats and adapters to prevent any further damage.
4. Regularly check the rotor bores for deposits and damage.

7.6 Decontamination before shipment

If you are shipping the device to the authorized Technical Service for repairs or to your authorized dealer for disposal please note the following:



WARNING! Risk to health from contaminated device

1. Follow the instructions in the decontamination certificate. You find it as a PDF file on our website (www.eppendorf.com/decontamination).
 2. Decontaminate all the parts you would like to dispatch.
 3. Include the fully completed decontamination certificate in the package.
-

Maintenance

Centrifuge 5804/5804 R/5810/5810 R
English (EN)

8 Troubleshooting

If you cannot remedy an error with the recommended measures, please contact your local Eppendorf partner. The contact address can be found online at: www.eppendorf.com/worldwide.

8.1 Resetting the excess current switch

The 230 V and 120 V devices have built-in thermal excess-current switches which function as (all-pole) fuses. When the overload protection is actuated, these switch the power switch to OFF, but do not switch it on again automatically.

To switch on the excess current switch again, proceed as follows:

1. Switch off the centrifuge using the power switch.
2. Wait for at least 20 seconds and switch on the centrifuge again.

The excess current switch will be automatically reactivated and the centrifuge is ready for operation.

8.2 General errors

Symptom/message	Cause	Remedy
No display.	No mains connection.	▶ Check mains connection.
Display shows <i>Interrupt</i> after the centrifuge has been switched on.	Power failure.	<ul style="list-style-type: none"> ▶ Check the mains fuse of the device (see <i>Resetting the excess current switch on p. 81</i>). ▶ Check the mains fuse of the laboratory. ▶ Press the open key.
Lid of the device cannot be opened.	Rotor is still running.	▶ Wait for rotor to stop.
Lid of the device cannot be opened.	Power failure.	<ol style="list-style-type: none"> 1. Check the mains fuse of the device (see <i>Resetting the excess current switch on p. 81</i>). 2. Check the mains fuse of the laboratory. 3. Activate the emergency lid release (see p. 84).
<i>Clean rotor</i>	200 runs.	▶ Clean the rotor and chamber (see p. 75).
Centrifuge brakes during a short run centrifugation, although the short key is pressed.	The short key was released briefly more than twice (protective function for the drive).	▶ Press the short key continuously during a short run centrifugation.

Troubleshooting

Centrifuge 5804/5804 R/5810/5810 R
English (EN)

8.3 Error messages

If one of the following error messages appears, proceed as follows:

1. Remove fault (see Remedy).
2. Press **open** key to clear the error message.
If necessary, repeat centrifugation.

Some errors can have various causes. The actual cause is described in the message in the device display.

Symptom/message	Cause	Remedy
<i>No rotor</i> Centrifuge does not start up.	No rotor.	▶ Insert the rotor.
<i>No rotor</i> Centrifuge does not start up.	Error in the drive or in the rotor detection.	▶ Switch centrifuge off and back on again after > 20 s.
<i>Press Open</i>	Centrifuge lid could not be locked.	1. Press the open key. 2. Try again to close centrifuge lid.
<i>Close lid</i>	Centrifuge lid not closed properly.	▶ Close the centrifuge lid firmly.
<i>Lift lid</i> The centrifuge lid does not open.	The centrifuge lid cannot open automatically.	▶ Lift the centrifuge lid manually.
<i>IMBAL</i> The centrifuge shakes when it starts up and switches off.	Rotor loaded unsymmetrically.	▶ Load the rotor symmetrically (see p. 58).
<i>ROTOR</i> The centrifuge shakes when it starts up and switches off.	Rotor not screwed sufficiently tight.	1. Tighten the rotor nut (see p. 58). 2. Check the rotor cone and motor shaft for grooves and damage.
<i>ROTOR</i> The centrifuge shakes when it starts up and switches off.	<ul style="list-style-type: none"> • Centrifuge was pushed. • Table is not stable. 	▶ Position the centrifuge on a stable table (see p. 53).
<i>SPEED</i> Centrifuge switches off.	Nominal speed for rotor too high.	▶ Enter the appropriate nominal speed (see p. 11).
<i>change rotor</i>	The maximum service life of the rotor has been reached. The warning is displayed after 98,000, 99,000 and 99,600 runs (3 times after each run). After 100,000 runs, it is displayed after every run.	▶ Contact Technical Service.

Symptom/message	Cause	Remedy
Temperature display flashes. (5804 R/5810 R only)	Temperature deviation from the set value: ± 3 °C.	<ul style="list-style-type: none"> ▶ Check the settings. ▶ Wait until the set temperature has been reached. ▶ Check unhindered air circulation through the air slots. ▶ Thaw ice or switch off device and allow it to cool down.
<i>Overtemp</i> (5804 R/5810 R only) Centrifuge switches off and issues a warning tone.	Temperature deviation from set value in the rotor chamber: ± 5 °C.	<ul style="list-style-type: none"> ▶ Check the settings. ▶ Check unhindered air circulation through the air slots. ▶ Thaw ice or switch off device and allow it to cool down.
<i>Clear memory</i>	Program memory full.	▶ Delete some programs (see p. 73).
<i>Interrupt</i>	Mains/power failure during a run.	▶ Check the mains connection.
<i>Error 1</i>	Error in speed measuring system.	▶ If this error message appears again, test with a different rotor.
<i>Error 2</i>	Imbalance sensor faulty.	▶ Repeat the run.
<i>Error 3</i>	Error in speed measuring system.	▶ Insert and tighten rotor.
<i>Error 3</i>	Error in speed measuring system.	▶ Allow the centrifuge to stand for 12 min when switched on until the open key lights up.
<i>Error 4</i>	Lid latch sensor faulty.	▶ Switch centrifuge off and back on again after > 20 s.
<i>Error 5</i>	Prohibited opening of lid or lid switch is defective during a run.	<ol style="list-style-type: none"> 1. Wait for rotor to stop. 2. Open and close again the lid of the device. 3. Repeat the run.
<i>Error 6 or overload</i>	Mains voltage too low.	▶ Check the mains voltage.
<i>Error 6 or overload</i>	<ul style="list-style-type: none"> • Converter overloaded. • Brake faulty. 	▶ Switch off centrifuge, allow to cool down for at least 5 min, and then switch on again.
<i>Error 8</i>	<ul style="list-style-type: none"> • Drive fault. • Rotor loose. • Motor defective. 	<ol style="list-style-type: none"> 1. Wait for rotor to stop. 2. Tighten rotor. 3. Repeat the run.
<i>Error 9 to Error 25</i>	Electronics fault.	▶ Switch centrifuge off and back on again after > 20 s.

Troubleshooting

Centrifuge 5804/5804 R/5810/5810 R
English (EN)

8.4 Emergency release

If the centrifuge lid cannot be opened, you can activate the emergency release manually.

**WARNING! Risk of injury from rotating rotor.**

If the emergency release of the lid is operated, the rotor may continue rotating for several minutes.

- ▶ Wait until the rotor stop before operating the emergency release.
 - ▶ Check the monitoring glass in the centrifuge lid.
-

You need the standard rotor key supplied with the centrifuge.

1. Disconnect the power plug.
2. Remove the plastic cover for the emergency release. This is located in the center on the front side of the device.
3. Insert the rotor key into the hexagonal opening behind until some resistance can be felt.
4. While keeping the rotor key pressed, turn it in a counterclockwise direction.
This will release the centrifuge lid.
5. Open the centrifuge lid.
6. Remove the rotor key and put the plastic covers back on.

9 Transport, storage and disposal

9.1 Transport



CAUTION! Risk of injury when lifting and carrying heavy loads

The device is heavy. Lifting and carrying the device can lead to back injuries.

- ▶ Only lift and transport the device with a sufficient number of helpers.
- ▶ Use a transport aid for transporting the device.

- ▶ Remove the rotor from the centrifuge before transport.
- ▶ Use the original packaging and the transport securing devices for transport.

	Air temperature	Relative humidity	Atmospheric pressure
General transport	-25 °C – 60 °C	10 % – 75 %	30 kPa – 106 kPa
Air freight	-20 °C – 55 °C	10 % – 75 %	30 kPa – 106 kPa

9.2 Storage

	Air temperature	Relative humidity	Atmospheric pressure
In transport packaging	-25 °C – 55 °C	10 % – 75 %	70 kPa – 106 kPa
Without transport packaging	-5 °C – 45 °C	10 % – 75 %	70 kPa – 106 kPa

9.3 Disposal

In case the product is to be disposed of, the relevant legal regulations are to be observed.

Information on the disposal of electrical and electronic devices in the European Community:

Within the European Community, the disposal of electrical devices is regulated by national regulations based on EU Directive 2002/96/EC pertaining to waste electrical and electronic equipment (WEEE).

According to these regulations, any devices supplied after August 13, 2005, in the business-to-business sphere, to which this product is assigned, may no longer be disposed of in municipal or domestic waste. To document this, they have been marked with the following identification:



Because disposal regulations may differ from one country to another within the EU, please contact your supplier if necessary.

10 Technical data

10.1 Power supply

Power connection:	230 V, 50 to 60 Hz 120 V, 60 Hz	
Current consumption:	5804/5810 (230 V): 5804/5810 (120 V): 5804 R/5810 R (230 V): 5804 R/5810 R (120 V), 20 A: 5804 R/5810 R (120 V), 15 A:	6 A 11 A 9 A/10 A 16 A 12 A
Power consumption:	5804/5810 (230 V): 5804/5810 (120 V): 5804 R/5810 R (230 V): 5804 R/5810 R (120 V), 20 A: 5804 R/5810 R (120 V), 15 A:	max. 900 W max. 950 W max. 1650 W max. 1650 W max. 1300 W
EMC: Interference emission (radio interference)	EN 61326-1 Class A	
EMC: Noise immunity	EN 61326	
Overvoltage category:	II	
Fuses:	5804/5810 (230 V): 5804/5810 (120 V): 5804 R/5810 R (230 V): 5804 R/5810 R (120 V), 20 A: 5804 R/5810 R (120 V), 15 A:	Excess current switch 12 A Excess current switch 12 A Excess current switch 12 A Excess current switch 18 A Excess current switch 15 A

10.2 Ambient conditions

Environment:	For indoor use only.	
Ambient temperature:	5804/5810: 5804 R/5810 R:	2 to 40°C 15 to 35°C
Max. relative humidity:	75%, non-condensing humidity	
Atmospheric pressure:	Use up to an altitude of 2000 m above MSL.	
Degree of pollution:	2	

Technical dataCentrifuge 5804/5804 R/5810/5810 R
English (EN)**10.3 Weight/dimensions**

Dimensions (W × D × H)	5804	466 × 550 × 337 mm (18.4 × 21.7 × 13.3 in.) Depth of footprint: 496 mm (19.5 in.)		
	5804 R	634 × 550 × 342 mm (25.0 × 21.7 × 13.5 in.) Depth of footprint: 496 mm (19.5 in.)		
	5810	535 × 608 × 345 mm (21.1 × 21.1 × 13.6 in.) Depth of footprint: 536 mm (21.1 in.)		
	5810 R	700 × 608 × 345 mm (27.6 × 23.9 × 13.6 in.) Depth of footprint: 536 mm (21.1 in.)		
Weight without rotor	5804	55 kg (121 lb.)		
	5804 R	80 kg (176 lb.)		
	5810	68 kg (150 lb.)		
	5810 R	99 kg (218 lb.)		
		Rotor		
		A-4-81 (4 × 500 mL)	A-4-44 (4 × 100 mL)	F-34-6-38 (6 × 85 mL)
Noise level	5804	-	< 67 dB(A)	< 51 dB(A)
	5804 R	-	< 56 dB(A)	< 58 dB(A)
	5810	< 65 dB(A)	< 65 dB(A)	< 53 dB(A)
	5810 R	< 56 dB(A)	< 56 dB(A)	< 59 dB(A)

The noise level was measured according to DIN EN ISO 3745 frontally in a sound measuring room with accuracy class 1 at a distance of 1 m from the device and at lab bench height.

10.4 Application parameters

Run time:	1 to 99 min, adjustable in 1 min increments. infinite (∞)	
Temperature (only 5804 R/5810 R):	-9 °C to 40 °C	
Relative centrifugal force (RCF or rcf):	10 to 20,913 x g adjustable up to 3,000 x g in 10 x g increments, thereafter in 100 x g increments.	
Rotational speed:	200 to 14,000 rpm, adjustable up to 5,000 rpm in 10 rpm increments, afterwards in 100 rpm increments.	
Max. load:	5804/5804 R: 5810/5810 R:	4 x 250 mL 4 x 750 mL
Max. kinetic energy:	5804/5810: 5804 R: 5810 R:	19,000 Nm (11,000 rpm) 19,000 Nm (11,000 rpm) 23,000 Nm (12,000 rpm)
Inspection obligation in Germany:	Yes	
Permitted density of the centrifugate (at max. g-force/rpm and max. load):	1.2 g/mL	
Standardized interface (optional)	RS 232 C	

Influence of speed on the temperature

Rotational speed	Temperature
11 000 rpm	Rotor FA-45-6-30: $\leq 4^{\circ}\text{C}$ Rotor F-34-6-38: $\leq 4^{\circ}\text{C}$
Maximum speed	Rotor FA-45-6-30: $\leq 10^{\circ}\text{C}$ Rotor F-34-6-38: $\leq 9^{\circ}\text{C}$

Acceleration and deceleration times (according to DIN 58970)

Tab. 10-1: Approximate acceleration times of the different rotors for the levels 0 to 9 (in seconds) for 230 V devices

5804/ 5804 R	5810/ 5810 R	Rotor	0	1	2	3	4	5	6	7	8	9
-	•	A-4-81	227	198	173	149	132	111	97	85	60	35
-	•	A-4-81-MTP/Flex	223	195	170	147	129	109	95	83	59	33
-	•	A-4-62	222	195	170	148	129	110	96	85	59	27
•	•	A-4-44	373	299	257	215	190	142	106	75	45	20
-	•	A-2-DWP-AT	256	223	191	167	147	126	111	98	72	45
•	•	A-2-DWP	203	176	133	117	100	78	61	45	36	18
•	•	FA-45-6-30	468	378	285	203	179	156	136	103	78	47
•	•	F-34-6-38	467	376	282	199	176	153	132	99	74	36

Technical data

Centrifuge 5804/5804 R/5810/5810 R
English (EN)

5804/ 5804 R	5810/ 5810 R	Rotor	0	1	2	3	4	5	6	7	8	9
•	•	F-45-30-11	282	143	96	73	59	50	44	37	33	19
•	•	F-45-48-PCR	244	123	83	63	51	43	38	32	28	14
•	•	T-60-11	284	145	99	77	63	55	49	43	39	28
-	•	S-4-104 (round bucket)	217	189	166	144	126	108	84	58	43	35
-	•	S-4-104 (plate bucket)	217	189	165	142	125	107	82	55	41	33
•	•	S-4-72	304	247	209	175	154	115	56	29	18	14
•	•	F-35-48-17	704	330	277	233	206	152	72	38	23	17

Tab. 10-2: Approximate deceleration times of the different rotors for the levels 0 to 9 (in seconds) for 230 V devices

5804/ 5804 R	5810/ 5810 R	Rotor	0	1	2	3	4	5	6	7	8	9
-	•	A-4-81	466	203	178	154	137	118	95	86	57	31
-	•	A-4-81-MTP/Flex	513	201	176	154	135	115	94	85	57	30
-	•	A-4-62	477	199	175	151	133	114	95	86	57	26
•	•	A-4-44	282	288	230	201	178	138	90	69	47	21
-	•	A-2-DWP-AT	611	227	197	172	153	130	108	97	66	34
•	•	A-2-DWP	274	182	140	122	105	83	57	45	34	14
•	•	FA-45-6-30	1139	392	296	216	190	167	131	98	80	53
•	•	F-34-6-38	735	385	290	210	184	161	130	97	80	48
•	•	F-45-30-11	317	148	77	54	42	36	27	23	20	18
•	•	F-45-48-PCR	171	128	69	47	36	31	23	20	17	15
•	•	T-60-11	638	295	153	107	85	69	50	43	40	35
-	•	S-4-104 (round bucket)	690	196	173	152	133	114	70	49	38	32
-	•	S-4-104 (plate bucket)	621	196	170	149	131	114	69	48	37	32
•	•	S-4-72	337	242	196	172	152	119	55	32	21	17
•	•	F-35-48-17	310	287	248	214	189	143	73	41	27	16

These values are to be considered as guidelines. Level 9 means "strongest braking", level 0 means "free deceleration". Considerable fluctuations can occur depending upon the condition of the device and the load. The deceleration times for the 230 and 120 V devices are almost identical.

11 Ordering information

11.1 Centrifuge 5804/5804 R

Please refer to our catalogue.

Order no. (International)	Order no. (North America)	Description
5804 000.013 5804 000.137	022622552 022622501	Centrifuge 5804 without rotor 230 V/50 – 60 Hz 120 V, 50 Hz – 60 Hz
5805 000.017 5805 000.130 5805 000.530	022623559 022623508 022625080	Centrifuge 5804 R refrigerated, without rotor 230 V/50 – 60 Hz 120 V/50 – 60 Hz, 15 A 120 V/50 – 60 Hz, 20 A

11.2 Centrifuge 5810/5810 R

Order no. (International)	Order no. (North America)	Description
5810 000.017 5810 000.130	022625055 022625004	Centrifuge 5810 without rotor 230 V/50 – 60 Hz 120 V/50 – 60 Hz, with US-plug
5811 000.010 5811 000.134 5811 000.533	022625551 022625501 022625101	Centrifuge 5810 R refrigerated, without rotor 230 V/50 – 60 Hz 120 V/50 – 60 Hz, 15 A, with US-plug 120 V/50 – 60 Hz, 20 A, with US-plug

11.3 Rotors and accessories

11.3.1 Rotor A-4-81 (only 5810/5810 R)

11.3.1.1 Rotor A-4-81, 500 mL bucket

Order no. (International)	Order no. (North America)	Description
5810 718.007 5810 743.001	022638602 022638611	Rotor A-4-81 for 500 mL rectangular buckets or MTP/Flex-buckets incl. 4 × 500 mL rectangular buckets without buckets
5810 730.007	022638629	Rectangular bucket 500 mL Set of 4
5810 724.007	022638661	Aerosol-tight cap for 500 mL rectangular buckets, 2 pieces
5810 733.006	022638670	Replacement cap sealing for aerosol-tight caps for 500 mL rectangular buckets, 4 pieces

Ordering information

Centrifuge 5804/5804 R/5810/5810 R
English (EN)

Order no. (International)	Order no. (North America)	Description
5810 745.004 5810 746.000	022638704 022638707	Adapter for 500 mL rectangular buckets for 20 sample tubes (1.5/2.0 mL, max. Ø 11 mm), set of 2 for 20 blood collection tubes (1.2 – 5 mL, max. Ø 11 mm), set of 2
5810 720.001 5825 717.007 5810 748.003	022638700 022638718 022638721	for 24 tubes (2.6 – 7 mL, max. Ø 13 mm), set of 2 for 18 tubes (5 mL, Monovette, max. Ø 13 mm), set of 2 for 16 blood collection tubes (3 – 15 mL, max. Ø 16 mm), set of 2
5810 721.008 5810 722.004 5810 723.000 5810 739.004	022638726 022638742 022638769 022638904	for 16 tubes (7 – 17 mL, max. Ø 17.5 mm), set of 2 for 12 conical tubes (15 mL, max. Ø 17.5 mm), set of 2 for 5 conical tubes (50 mL, max. Ø 31 mm), set of 2 for 5 Centriprep Centrifugal Filter Units (max. Ø 31 mm), set of 2
5825 722.000 5810 728.002	022638921 022638785	for 1 bottle (180 – 250 mL, max. Ø 62 mm), set of 2 for 1 bottle (400 mL, max. Ø 81 mm), set of 2
5804 737.008	022654373	Adapter for 50 mL skirted conical tubes, set of 8
5810 734.002	022638688	Replacement rubber mat for adapters for 500 mL rectangular buckets set of 4
5810 735.009	022638696	Replacement clamp for adapters for 500 mL rectangular buckets 2 pieces
5810 729.009 5820 707.003	022638653 022638657	Wide-neck bottle for Rotor A-4-81 400 mL, set of 2 500 mL, rectangular, set of 2
5810 718.309	022664174	Rotor key for Rotor A-4-81, S-4-104

11.3.1.2 Rotor A-4-81, MTP/Flex carrier

Order no. (International)	Order no. (North America)	Description
5810 725.003	022638807	Rotor A-4-81-MTP/Flex Swing-bucket rotor, incl. 4 MTP/Flex buckets
5810 741.009 5810 742.005	022638840 022638866	MTP/Flex buckets for Rotor A-4-81 or A-4-81-MTP/Flex for use with IsoRack and cell culture flask adapters as well as MTP and DWP set of 4 set of 2
5825 708.008 5825 709.004	022638980 022638998	IsoRack adapter for 24 × 0.5 mL tubes in the IsoRack, set of 2 for 24 × 1.5/2.0 mL tubes in the IsoRack, set of 2
5825 721.004	022510070	IsoRack starter set for Flex buckets 2 × IsoRack Adapter, 2 × IsoRacks with lid, 2 × cool packs (0 °C IsoPack) for 0.5 mL and 1.5/2.0 mL sample tubes
5825 711.009 5825 713.001	022638947 022638955	Adapter used in A-4-81-MTP/Flex, A-4-62-MTP, A-2-DWP-AT and A-2-DWP for 96-well PCR plates, set of 2 for 384-well PCR plates, set of 2
5825 706.005	022638963	Adapter used in A-4-81-MTP/Flex, A-4-62-MTP and A-2-DWP CombiSlide Adapter, set of 2
5825 719.000	5825719000	Adapter used in A-4-81-MTP/Flex and A-4-62-MTP for 1 cell culture bottle, set of 2

11.3.1.3 Rotor A-4-81, bucket for conical tubes

Order no. (International)	Order no. (North America)	Description
5825 730.003	022638614	Bucket for A-4-81 for 7 50 mL conical tubes, set of 4
5820 718.005	5820718005	Adapter used in FA-45-6-30 for 15 mL conical tubes, set of 7

Ordering information

Centrifuge 5804/5804 R/5810/5810 R
English (EN)

11.3.2 Rotor A-4-62 and A-4-62-MTP (only 5810/5810 R)

11.3.2.1 Rotor A-4-62

Order no. (International)	Order no. (North America)	Description
5810 709.008	022638009	Rotor A-4-62 incl. 4 × 250 mL rectangular buckets
5810 716.004	022638084	Rectangular bucket 250 mL Set of 4
5810 710.006	022638033	Aerosol-tight caps for 250 mL rectangular buckets, set of 2
5810 713.005	022638017	Spare sealing for aerosol-tight caps for 250 mL rectangular buckets Set of 4
5810 751.004 5810 750.008 5810 752.000 5810 753.007 5810 754.003 5810 756.006 5810 757.002 5810 759.005 5810 760.003 5810 761.000 5810 770.009 5810 755.000 5810 758.009 5810 763.002	022638220 022638203 022638246 022638262 022638301 022638327 022638360 022638386 022638408 022638424 022638441 022638289 022638343 022638351	Adapter for 250 mL rectangular buckets for 16 sample tubes (1.5/2.0 mL, max. Ø 11 mm), set of 2 for 25 tubes (1.2 – 5 mL, max. Ø 11 mm), set of 2 for 15 tubes (2.6 – 7 mL, max. Ø 13 mm), set of 2 for 12 tubes (3 – 15 mL, max. Ø 16 mm), set of 2 for 12 tubes (7 – 17 mL, max. Ø 17.5 mm), set of 2 for 8 tubes (7 – 18 mL, max. Ø 20 mm), set of 2 for 4 tubes (18 – 30 mL, max. Ø 26 mm), set of 2 for 4 tubes (30 – 50 mL, max. Ø 31 mm), set of 2 for 2 tubes (50 – 75 mL, max. Ø 35 mm), set of 2 for 1 tube (80 – 120 mL, max. Ø 45 mm), set of 2 for 1 bottle (180 – 250 mL, max. Ø 62 mm), set of 2 for 9 conical tubes (15 mL, max. Ø 17.5 mm), set of 2 for 3 conical tubes (50 mL, max. Ø 31 mm), set of 2 for 4 conical tubes (50 mL), operation w/o aerosol-tight cap, set of 2
5804 737.008	022654373	Adapter for 50 mL skirted conical tubes, set of 8
5810 782.007	022638483	Replacement rubber mat for adapters for 250 mL rectangular buckets Set of 4
5810 781.000	022662431	Replacement clamp for adapters for 250 mL rectangular buckets Set of 2
5810 783.003	022638459	Replacement rubber mat for adapter 5810 770.009/022638441 Set of 4

11.3.2.2 Rotor A-4-62-MTP

Order no. (International)	Order no. (North America)	Description
5810 711.002	022638041	Rotor A-4-62-MTP incl. 4 MTP buckets
5810 702.003	022638068	MTP bucket for A-4-62 for 4 MTP or 1 DWP Set of 4
5825 711.009 5825 713.001	022638947 022638955	Adapter used in A-4-81-MTP/Flex, A-4-62-MTP, A-2-DWP-AT and A-2-DWP for 96-well PCR plates, set of 2 for 384-well PCR plates, set of 2
5825 706.005	022638963	Adapter used in A-4-81-MTP/Flex, A-4-62-MTP and A-2-DWP CombiSlide Adapter, set of 2

11.3.3 Rotor A-4-44

Order no. (International)	Order no. (North America)	Description
5804 709.004	022637401	Rotor A-4-44 incl. 4 × 100 mL rectangular buckets
5804 741.005	022637436	Rectangular bucket 100 mL set of 4
5804 712.005	022637428	Aerosol-tight cap for 100 mL rectangular buckets, set of 2
5804 713.001	022637444	4 Replacement gasket for aerosoltight caps for 100 mL rectangular buckets, set of 4
5804 751.000 5804 750.004 5804 752.007 5804 753.003 5804 754.000 5804 756.002 5804 757.009 5804 759.001 5804 760.000 5804 761.006 5804 755.006 5804 717.007 5804 758.005 5804 718.003	022637525 022637509 022637541 022637568 022637584 022637622 022637649 022637681 022637703 022637720 022637606 022637614 022637665 022637673	Adapter for 100 mL rectangular bucket for 12 sample tubes (1.5/2.0 mL, max. Ø 11 mm), set of 2 for 14 tubes (1.2 – 5 mL, max. Ø 11 mm), set of 2 for 9 tubes (2.6 – 7 mL, max. Ø 13 mm), set of 2 for 7 tubes (3 – 15 mL, max. Ø 16 mm), set of 2 for 6 tubes (7 – 17 mL, max. Ø 17.5 mm), set of 2 for 4 tubes (7 – 18 mL, max. Ø 20 mm), set of 2 for 2 tubes (18 – 30 mL, max. Ø 26 mm), set of 2 for 1 tube (30 – 50 mL, max. Ø 31 mm), set of 2 for 1 tube (50 – 75 mL, max. Ø 35 mm), set of 2 for 1 tube (80 – 100 mL, max. Ø 45 mm), set of 2 for 4 conical tubes (15 mL, max. Ø 17.5 mm), set of 2 for 2 conical tubes (15 mL, max. Ø 17.5 mm), set of 2 for 1 conical tube (50 mL, max. Ø 31 mm), set of 2 for 1 conical tube (50 mL, max. Ø 31 mm), set of 2

Ordering information

Centrifuge 5804/5804 R/5810/5810 R
English (EN)

Order no. (International)	Order no. (North America)	Description
5804 737.008	022654373	Adapter for 50 mL skirted conical tubes, set of 8
5804 782.003	022662503	Rubber mat for adapters of Rotor A-4-44 Set of 4
5804 781.007	022662511	Replacement clamp for adapters of rotor A-4-44 Set of 2
5804 706.005	022637452	Bucket for A-4-44 for 2 Falcon tubes (50 mL, max. Ø 31 mm), set of 4
5804 728.009	022637479	Adapter Form inserts for buckets with conical tubes for 1 conical tube (50 mL, max. Ø 31 mm), set of 8

11.3.4 Rotor A-2-DWP-AT (only 5810/5810 R)

Order no. (International)	Order no. (North America)	Description
5820 710.004	5820710004	Rotor A-2-DWP-AT incl. 2 buckets, 2 aerosol-tight caps and 2 plate holders
5820 711.000	5820711000	Bucket for rotor A-2-DWP-AT 2 pieces
5820 713.003	5820713003	Aerosol-tight bucket cap, Rotor A-2-DWP-AT 2 pieces
5820 705.000	5820705000	Spare seal for aerosoltight cap 2 pieces
5820 756.004	5820756004	Plate carrier Rotors A-2-DWP-AT, S-4-104, S-4x750 Set of 2 pieces
5825 711.009 5825 713.001	022638947 022638955	Adapter used in A-4-81-MTP/Flex, A-4-62-MTP, A-2-DWP-AT and A-2-DWP for 96-well PCR plates, set of 2 for 384-well PCR plates, set of 2

Aerosol impermeability tested and certified by the Centre of Emergency Preparedness and Response, Health Protection Agency, Porton Down (UK).

11.3.5 A-2-DWP rotor

Order no. (International)	Order no. (North America)	Description
5804 740.009	022638564	Rotor A-2-DWP Deepwell plates rotor, incl. 2 buckets
5804 743.008	022638556	Plate bucket used in A-2-DWP set of 2
5825 718.003	5825718003	SBS adapter for plates with rims in the SBS format Set of 2
5825 708.008 5825 709.004	022638980 022638998	IsoRack adapter for 24 × 0.5 mL tubes in the IsoRack, set of 2 for 24 × 1.5/2.0 mL tubes in the IsoRack, set of 2
5825 711.009 5825 713.001	022638947 022638955	Adapter used in A-4-81-MTP/Flex, A-4-62-MTP, A-2-DWP-AT and A-2-DWP for 96-well PCR plates, set of 2 for 384-well PCR plates, set of 2
5825 706.005	022638963	Adapter used in A-4-81-MTP/Flex, A-4-62-MTP and A-2-DWP CombiSlide Adapter, set of 2

11.3.6 Rotor FA-45-6-30

Order no. (International)	Order no. (North America)	Description
5820 715.006	5820715006	Rotor FA-45-6-30 aerosol-tight*, aluminum, 45° angle, 6 places, for 15/ 50 mL conical tubes, incl. rotor lid (aluminum)
5820 716.002	5820716002	Rotor lid for FA-45-6-30 aerosol-tight, aluminum
5418 709.008	022652109	Seal for rotor lid FA-45-18-11 (5418/5418 R), FA-45-6-30 (5804/5804 R/5810/ 5810 R), FA-6x50 (5920 R) 5 pieces
5820 717.009 5820 720.000 5820 721.006 5820 722.002 5820 730.005 5820 726.008	5820717009 5820720000 5820721006 5820722002 5820730005 5820726008	Adapter used in rotor FA-45-6-30 for 1 conical tubes 15 mL (max. Ø 17 mm), set of 2 pieces for 1 Oak Ridge 16 mL (max. Ø 18 mm), set of 2 pieces for 1 Oak Ridge 30 mL (max. Ø 26 mm), set of 2 pieces for 1 Oak Ridge 35 mL (max. Ø 30 mm), set of 2 pieces for 1 tube 5 mL (max. Ø 17 mm), set of 2 pieces for 1 round-bottom and blood collection tube (13 mm × 75 mm), set of 2 pieces
5820 725.001	5820725001	for 1 round-bottom and blood collection tube (13 mm × 100 mm), set of 2 pieces

Ordering information

Centrifuge 5804/5804 R/5810/5810 R
English (EN)

Order no. (International)	Order no. (North America)	Description
5820 728.000	5820728000	for 1 Oak Ridge 10 mL, round-bottom and blood collection tube (13 mm × 75 mm), set of 2 pieces
5820 727.004	5820727004	for 1 round-bottom and blood collection tube (16 mm × 100 mm), set of 2 pieces
5820 729.007	5820729007	for 1 round-bottom and blood collection tube (17,5 mm × 100 mm), set of 2 pieces

Aerosol impermeability tested and certified by the Centre of Emergency Preparedness and Response, Health Protection Agency, Porton Down (UK).

11.3.7 Rotor F-34-6-38

Order no. (International)	Order no. (North America)	Description
5804 727.002	022637207	Rotor F-34-6-38 34° angle, 6 places for 85 mL tubes, incl. rotor lid
5804 727.509	022662961	Rotor lid F-34-6-38, F-6x85 aluminum
		Adapter used in F-34-6-38
5804 770.005	022637215	for 4 sample tubes 1.5/2.0 mL (max. Ø 11 mm), set of 2
5804 777.000	5804777000	for 1 tube 5 mL (max. Ø 17 mm), set of 2 pieces
5804 738.004	022637279	for 3 round-bottom and blood collection tubes (13 × 75 mm), set of 2 pieces
5804 739.000	022637282	for 3 round-bottom and blood collection tubes (13 × 100 mm), set of 2 pieces
5804 771.001	022637223	for 2 tubes (7 bis 15 mL, max. Ø 16 mm), set of 2
5804 776.003	022637274	for 1 conical tube (15 mL, max. Ø 17 mm), set of 2
5804 772.008	022637231	for 1 tube (15 bis 18 mL, max. Ø 18 mm), set of 2
5804 773.004	022637240	for 1 tube (20 bis 30 mL, max. Ø 26 mm), set of 2
5804 774.000	022637258	for 1 tube (50 mL, max. Ø 29 mm), set of 2
5804 775.007	022637266	for 1 conical tube (50 mL, max. Ø 29.5 mm), set of 2

11.3.8 Rotor FA-45-30-11 and rotor F-45-30-11

Order no. (International)	Order no. (North America)	Description
5804 726.006	022637100	Rotor FA-45-30-11 aerosol-tight*, 45° angle, 30 places for 1.5/2.0 mL tubes, incl. rotor lid (aluminum)
5804 736.001	022637126	Rotor lid for FA-45-30-11 aerosol-tight, aluminum
5804 715.004	022637002	Rotor F-45-30-11 45° angle, 30 places for 1.5/2.0 mL tubes, incl. rotor lid (aluminum)
5804 715.403	022662970	Rotor lid for F-45-30-11 not aerosol-tight, aluminum
5425 715.005 5425 717.008 5425 716.001	022636260 022636243 022636227	Adapter used in FA-45-30-11 and F-45-30-11 for 1 PCR tube (0.2 mL, max. Ø 6 mm), set of 6 for 1 sample tube (0.4 mL, max. Ø 6 mm), set of 6 for 1 sample tube (0.5 mL, max. Ø 6 mm) or 1 Microtainer (0.6 mL, max. Ø 8 mm), set of 6

11.3.9 Rotor F-45-48-PCR

Order no. (International)	Order no. (North America)	Description
5804 735.005	022638581	Rotor F-45-48-PCR 45° angle, for 6 × 8-tube strips, 6 × 5-tube strips or 48 × 0.2 mL PCR tubes

11.3.10 Rotor T-60-11

Order no. (International)	Order no. (North America)	Description
5804 730.003	022638505	Rotor T 60-11 for 60 × 1.5/2.0 mL tubes incl. rotor lid, and 6 adapters for 1.5/2 mL sample tubes
5804 731.000 5804 732.006	022638521 022638548	Adapter used in T-60-11 for 10 sample tubes (1,5/2,0 mL, max. Ø 11 mm), set of 6 for 20 sample tubes (0.4 mL, max. Ø 6 mm), set of 6

Ordering informationCentrifuge 5804/5804 R/5810/5810 R
English (EN)

11.3.11 Rotor S-4-104

Order no. (International)	Order no. (North America)	Description
5820 740.000	5820740000	Rotor S-4-104 4 × 750 mL incl. 4 round buckets 750 mL for Centrifuges 5810/5810 R
5820 754.001	5820754001	Rotor S-4-104 incl. 4 plate buckets (aerosol-tight capable) inkl. plate carrier
5820 755.008	5820755008	Rotor S-4-104 without buckets
5825 740.009	5825740009	Adapter used in rotor S-4-104 for 50 tubes 1,5 mL/2,0 mL (max. Ø 11 mm), set of 2 pieces for 14 tubes 5 mL (max. Ø 17 mL), set of 2 pieces for 23 round-bottom tubes and blood collection tubes (13 mm × 75 - 100 mm), set of 2 pieces for 20 round-bottom tubes and blood collection tubes (16 mm × 75 - 100 mm), set of 2 pieces for 20 round-bottom tubes and blood collection tubes (17,5 mm × 100 mm), set of 2 pieces for 14 conical tubes 15 mL (max. Ø 17 mm), set of 2 pieces for 7 conical tubes 50 mL (max. Ø 30 mm), set of 2 pieces for 5 skirted conical tubes (max. Ø 30 mm), set of 2 pieces für 1 tube 175 - 250 mL (max. Ø 62 mm), set of 2 pieces for 1 Corning 500 mL Centrifuge Tube (max. Ø 96 mL), set of 2 pieces for 1 wide-neck bottle 750 mL (max. Ø 102 mL), set of 2 pieces
5825 739.000	5825739000	
5825 738.004	5825738004	
5825 736.001	5825736001	
5825 743.008	5825743008	
5825 734.009	5825734009	
5825 733.002	5825733002	
5825 732.006	5825732006	
5825 741.005	5825741005	
5825 745.000	5825745000	
5820 708.000	5820708000	Wide-neck bottle for rotor S-4-104 750 mL, set of 2
5820 742.003	5820742003	Bucket 750 mL for rotor S-4-104 Set of 2 Set of 4
5820 741.007	5820741007	
5820 744.006	5820744006	Plate bucket (aerosol-tight capable) for rotor S-4-104, incl. base plate and plate carrier Set of 2 Set of 4
5820 743.000	5820743000	
5820 746.009	5820746009	Plate bucket for rotor S-4-104 Set of 2 Set of 4
5820 745.002	5820745002	
5820 758.007	5820758007	Plate bucket (open) for rotor S-4-104 set of 2 set of 4
5820 757.000	5820757000	

Order no. (International)	Order no. (North America)	Description
5820 748.001	5820748001	Aerosol-tight cap Rotor S-4-104, Plate Bucket 2 pieces
5820 756.004	5820756004	Plate carrier Rotors A-2-DWP-AT, S-4-104, S-4x750 Set of 2 pieces
5820 751.002	5820751002	Base element for plate buckets for Rotors S-4-104 Set of 2 pieces
5820 750.006	5820750006	Sealings for aerosol-tight caps Rotors S-4-104, S-4x750, S-4x1000, Plate/Tube Bucket 4 pieces
5820 747.005	5820747005	Aerosol-tight cap Rotors S-4-104, S-4-104, S-4x750, S-4x1000, round bucket 750 mL/1000 mL 2 pieces
5820 749.008	5820749008	Sealings for aerosol-tight caps Rotors S-4-104, S-4-104, S-4x750, S-4x1000, round bucket 750 mL/1000 mL 4 pieces
5810 718.309	022664174	Rotor key for Rotor A-4-81, S-4-104

11.3.12 Rotor S-4-72

Order no. (International)	Order no. (North America)	Description
5804 746.007	5804746007	Rotor S-4-72 4 × 250 mL incl. 4 round buckets 250 mL for Centrifuges 5804/5804 R/ 5810/5810 R
5804 794.001	5804794001	Adapter used in rotor S-4-72 for 26 tubes 1,5/2,0 mL (max. Ø 11 mm), set of 2 pieces for 8 tubes 5 mL (max. Ø 17 mm), set of 2 pieces for 14 round-bottom und blood collection tubes (13 mm × 75 - 100 mm), set of 2 pieces for 13 round-bottom und blood collection tubes (16 mm × 75 - 100 mm), set of 2 pieces for 12 round-bottom und blood collection tubes (17,5 mm × 100 mm), set of 2 pieces for 8 conical tubes 15 mL (max. Ø 17 mm), set of 2 pieces for 4 conical tubes 50 mL (max. Ø 30 mm), set of 2 pieces for 2 conical tubes 15 mL, 50 mL (max. Ø 17 mm, Ø 30 mm), set of 2 pieces for 1 tube 175 - 250 mL (max. Ø 62 mm), set of 2 pieces
5804 793.005	5804793005	
5804 789.008	5804789008	
5804 791.002	5804791002	
5804 792.009	5804792009	
5804 783.000	5804783000	
5804 784.006	5804784006	
5804 785.002	5804785002	
5804 787.005	5804787005	

Ordering information

Centrifuge 5804/5804 R/5810/5810 R
English (EN)

Order no. (International)	Order no. (North America)	Description
5804 747.003	5804747003	Buckets 250 mL for Rotor S-4-72 Set of 4

11.3.13 Rotor F-35-48-17

Order no. (International)	Order no. (North America)	Description
5820 771.003	5820771003	Rotor F-35-48-17 incl. 24 steel sleeves and adapter for 24 × 15 mL tubes for Centrifuges 5804/5804 R/5810/ 5810 R
5820 772.000	5820772000	Rotor F-35-48-17 incl. 48 steel sleeves and adapter for 48 × 15 mL tubes for Centrifuges 5804/5804 R/5810/ 5810 R
5820 774.002	5820774002	Steel sleeves incl. adapter for Rotor F-35-48-17 for 36 conical tubes 15 mL and 48 round-bottom and blood collection tube (max. Ø 16 mm × 100 mm), set of 24 pieces

11.3.14 Rotor FA-45-48-11

Order no. (International)	Order no. (North America)	Description
5820 760.001	5820760001	Rotor FA-45-48-11 aerosol-tight, for 48 × 1.5/2 mL tubes, incl. aerosol-tight rotor lid for Centrifuges 5804/5804 R/5810/5810 R
5820 761.008	5820761008	Rotor lid, aerosol-tight for rotor FA-45-48-11 1 piece
5820 767.006	5820767006	Seal for rotor lid FA-45-24-11-Kit (5427 R/5430/5430 R), FA-45-48-11 (5804/ 5804 R/5810/5810 R), FA-30x2, FA-48x2 (Centrifuge 5920 R) 5 pieces

11.3.15 Rotor FA-45-20-17

Order no. (International)	Order no. (North America)	Description
5820 765.003	5820765003	Rotor FA-45-20-17 aerosol-tight, for 20 × 5 mL tubes, incl. aerosol-tight rotor lid for Centrifuges 5804/5804 R/5810/5810 R
5820 766.000	5820766000	Rotor lid, aerosol-tight for rotor FA-45-20-17 1 piece
5820 767.006	5820767006	Seal for rotor lid FA-45-24-11-Kit (5427 R/5430/5430 R), FA-45-48-11 (5804/5804 R/5810/5810 R), FA-30x2, FA-48x2 (Centrifuge 5920 R) 5 pieces
5820 768.002 5820 769.009	5820768002 5820769009	Adapter used in rotor FA-45-12-17 (5427 R), FA-45-16-17 (5430/5430 R), FA-45-20-17 (5804/5804 R/5810/5810 R) for 1 tube 1,5 mL/2,0 mL (max. Ø 11 mm), set of 10 pieces for 1 Cryo tube, set of 4 pieces
5820 770.007	5820770007	Adapter used in Rotor FA-45-12-17 (5427 R), FA-45-16-17 (5430/5430 R), FA-45-20-17 (5804/5804 R/5810/5810 R) for 1 HPLC vial, set of 10 pieces

11.3.16 Miscellaneous

Order no. (International)	Order no. (North America)	Description
5804 720.008	022639021	Rotor stand suitable for all rotors of Centrifuge 5804/5804 R/5810/5810 R
5810 350.050	022634330	Pivot grease Tube 20 mL
5810 350.018 5810 718.309	022664166 022664174	Rotor key Standard for Rotor A-4-81, S-4-104
5811 001.068	022662678	Tray for condensation water
on request on request	on request on request	Conversion kit for RS -232 interface For Centrifuge 5804 For Centrifuge 5804 R

Ordering information

Centrifuge 5804/5804 R/5810/5810 R
English (EN)

11.3.16.1 Power cable for Centrifuge 5804 and Centrifuge 5810

Order no. (International)	Order no. (North America)	Description
		Mains/power cable
0113 200.111	–	230 V/50 Hz, Europe
0013 594.490	–	230 V/50 Hz, GB/HK
0013 613.952	–	230 V/50 Hz, CN
0013 592.454	–	230 V/50 Hz, AUS
0113 200.863	022664999	120 V/60 Hz, USA
5804 652.002	–	202 V, Japan
0013 613.973	–	230 V/50 Hz, ARG

11.3.16.2 Power cable for Centrifuge 5804 R and Centrifuge 5810 R

Order no. (International)	Order no. (North America)	Description
		Mains/power cable
0113 204.486	–	230 V/50 Hz, Europe
0113 204.680	–	230 V/50 Hz, GB/HK
0013 613.953	–	230 V/50 Hz, CN
0113 204.699	–	230 V/50 Hz, AUS
0113 200.863	022664999	120 V/60 Hz, USA
0113 205.105	–	230 V/50 Hz, ARG
		Mains/power cable
5821 609.005	–	202 V, Japan

11.3.16.3 Connecting cable for Centrifuge 5804 / 5804 R and 5810 / 5810 R with rolling cabinet with transformer

Order no. (International)	Order no. (North America)	Description
5821 851.094		Cable for rolling cabinet - centrifuge 15 A

12 Annex Short instructions

You will find a detailed description of these figures in your language in Chapters 2.1 and 5.1.



Fig. 12-1: Depiction of Centrifuge 5810 and 5810 R. The Centrifuges 5804 and 5804 R are similar in design.

- 1 Centrifuge lid
- 2 Monitoring glass
- 3 Control panel with display
- 4 Emergency release
- 5 Condensation water tray (only Centrifuge 5804 R/5810 R)

Task/function	Press	Display	Details
Set parameter	1. Press speed or time etc. 2. Press ▲ or ▼ .	1. Selected parameter flashes. New value appears.	Chapter 5.4.1
Soft start/stop	1. Press time repeatedly. 2. Press ▲ or ▼ to select ramp.	↗: Acceleration ramp 0 (long) ... 9 (short). ↘: Deceleration ramp 0 (long) ... 9 (short).	Chapter 6.2 (English, German)
Alarm ON/OFF	▶ Press speed + time simultaneously.	<i>Alarm on/Alarm off</i>	Chapter 6.7.2 (English, German)
Programming (during rotor stop only)	1. Set parameter. 2. Press 2 x prog . 3. Store: Press prog > 2 s.	1. Parameter. 2. P...: first idle program no. OK	Chapters 6.4 - 6.6 (English, German)
At set rpm (with open centrifuge lid only)	Press start stop > 4 s.		Chapter 6.3 (English, German)

Annex Short instructions

Centrifuge 5804/5804 R/5810/5810 R
English (EN)

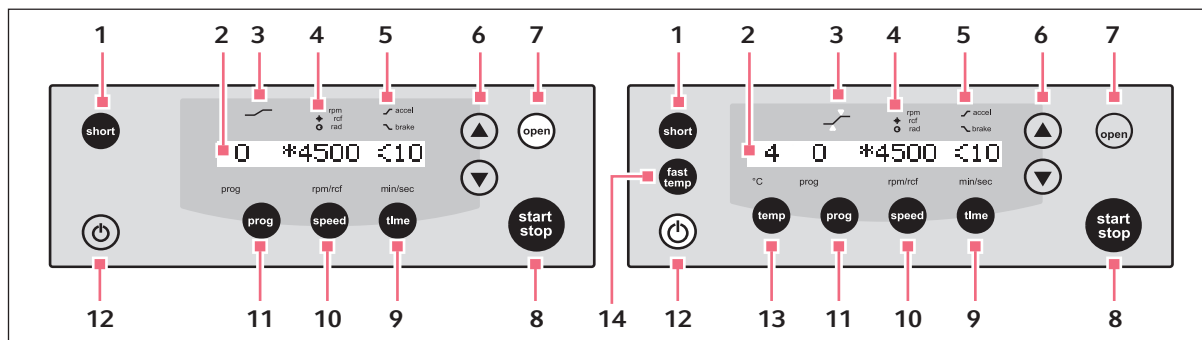


Fig. 12-2: Control panel of the Centrifuge 5804/5810 and the Centrifuge 5804 R/5810 R.

- | | |
|--|--|
| 1 Short spin centrifugation | 8 Start or stop centrifugation |
| 2 Display | 9 Adjust centrifugation time |
| 3 Status At set rpm function | 10 Set centrifugation speed |
| 4 Indicate speed (rpm), g-force (rcf) * and radius setting \odot . | 11 Select or save program |
| 5 Symbol for acceleration \swarrow and braking \searrow | 12 Standby |
| 6 Set parameters and values | 13 Set temperature (only 5804 R/5810 R) |
| 7 Release centrifuge lid | 14 Start temperature control run FastTemp (only 5804 R/5810 R) |

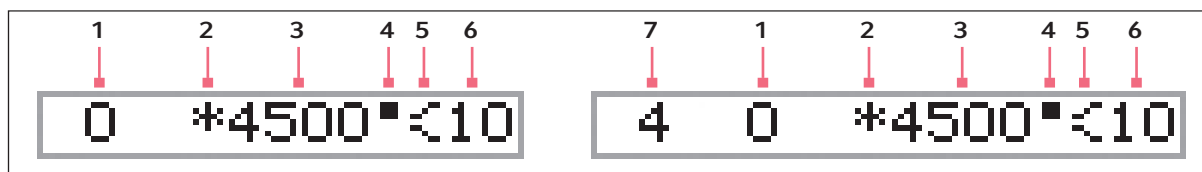


Fig. 12-3: Display of the Centrifuge 5804/5810 and the Centrifuge 5804 R/5810 R

- | | |
|--|---|
| 1 Program number | 5 Symbol for acceleration \swarrow and braking \searrow |
| 2 Symbol for g-force (rcf) | 6 Centrifugation time |
| 3 g-force (rcf)/rotational speed (rpm) | 7 Temperature (only 5804 R/5810 R) |
| 4 Symbol flashes when rotor is in motion | |

Rotorkennung

Die Bezeichnung aller Eppendorf-Rotoren folgt einem logischen Prinzip, das die technischen Spezifikationen in eine einheitliche Folge von Zahlen und Buchstaben umsetzt, wie zum Beispiel:

<p>Festwinkelrotor</p> <p>F A — 45 — 30 — 11</p> <p>Aerosoldichte Version Anzahl der Bohrungen</p>	<p>Winkel der Bohrungen</p> <p>Ø der Bohrungen (mm)</p>	<p>Ausschwingrotor</p> <p>S — 4 — 72</p> <p>Anzahl der Becher</p>	<p>Ø der Becher (mm)</p>
--	---	--	--------------------------

Rotorkennung

Die Bezeichnung aller Eppendorf-Rotoren folgt einem logischen Prinzip, das die technischen Spezifikationen in eine einheitliche Folge von Zahlen und Buchstaben umsetzt, wie zum Beispiel:

<p>Festwinkelrotor</p> <p>F A — 45 — 30 — 11</p> <p>Aerosoldichte Version Anzahl der Bohrungen</p>	<p>Winkel der Bohrungen</p> <p>Ø der Bohrungen (mm)</p>	<p>Ausschwingrotor</p> <p>A — 4 — 81</p> <p>Anzahl der Becher</p>	<p>Ø der Becher (mm)</p>
--	---	--	--------------------------

Declaration of Conformity

The product named below fulfills the requirements of directives and standards listed. In the case of unauthorized modifications to the product or an unintended use this declaration becomes invalid.

Product name:

Centrifuge 5804 / 5804 R , 5810 / 5810 R

including accessories

Product type:

Laboratory Centrifuges

Relevant directives / standards:

2006/95/EG: EN 61010-1, EN 61010-2-20

2004/108/EG: EN 61000-6-1, EN 61000-3-2, EN 61000-3-3, EN 61326-1

98/79/EG: EN 14971, EN 61010-2-101, EN 61326-2-6, EN 62366, EN 18113-3

2011/65/EU



Management Board



Portfolio Management

Date: November, 26, 2013

Your local distributor: www.eppendorf.com/contact
Eppendorf AG · 22331 Hamburg · Germany
eppendorf@eppendorf.com

ISO 9001
Certified

ISO 13485
Certified

ISO 14001
Certified

Eppendorf and the Eppendorf Logo are registered trademarks of Eppendorf AG Hamburg/Germany.
All rights reserved incl. graphics and pictures. Copyright 2013 © by Eppendorf AG.

Certificate of Compliance

Certificate Number 20111226-E215059
Report Reference E215059- E215059-A3-UL
Issue Date 2011-DECEMBER-26

Page 1 of 1



Issued to: EPPENDORF A G
BARKHAUSENWEG 1
22339 HAMBURG GERMANY

This is to certify that representative samples of **LABORATORY USE ELECTRICAL EQUIPMENT**
Models 5804, 5805T, 5805F, 5810, 5811T, 5811F


Have been investigated by Underwriters Laboratories in accordance with the Standard(s) indicated on this Certificate.

Standard(s) for Safety: UL 61010-1, (Electrical Equipment for Measurement, Control, and Laboratory Use; Part 1: General Requirements)
CAN/CSA-C22.2 No. 61010-1, (Electrical Equipment for Measurement, Control, and Laboratory Use; Part 1: General Requirements)
IEC 61010-2-020-Safety Requirements for Electrical Equipment for Measurement, Control, and Laboratory use.

Additional Information: See UL On-line Certification Directory at WWW.UL.COM for additional information.

This is to certify that representative samples of the product as specified on this certificate were tested according to the current UL requirements.

Only those products bearing the UL Listing Mark for the US and Canada should be considered as being covered by UL's Listing and Follow-Up Service meeting the appropriate requirements for US and Canada.

The UL Listing Mark for the US and Canada generally includes: the UL in a circle symbol with "C" and "US" identifiers:  the word "LISTED"; a control number (may be alphanumeric) assigned by UL; and the product category name (product identifier) as indicated in the appropriate UL Directory.

Look for the UL Listing Mark on the product

William R. Carney
Director, North American Certification Programs

Underwriters Laboratories Inc.

Any information and documentation involving UL Mark services are provided on behalf of Underwriters Laboratories Inc. (UL) or any authorized licensee of UL.

For questions, please contact a local UL Customer Service Representative at <http://www.ul.com/global/eng/pages/corporate/contactus>



Certificate of Containment Testing

Containment Testing of Swing Out Rotor with Buckets [A-2-DWP-AT (5820 710.004-00)] and Autoclaved (x50) lids in the Eppendorf Centrifuge 5810

Report No. 104-09 B

Report prepared for: Eppendorf AG, Hamburg, Germany
Issue Date: 31st March 2010 (amended 17th Aug 10)

Test Summary

Swing out rotor with buckets [A-2-DWP-AT (5820 710.004-00)] and autoclaved (x50) lids was containment tested in the Eppendorf 5810 centrifuge, in accordance with Annex AA of IEC 1010-2-20. The sealed bucket was shown to contain the spill of micro-organisms and therefore prevent any release.

Report Written By

A handwritten signature in blue ink, appearing to be "Alloc", written over a horizontal dashed line.

Report Authorised By

A handwritten signature in blue ink, written over a horizontal dashed line.



Certificate of Containment Testing

Containment Testing of Rotor A-4-44 and Sealed Buckets and Lids (Cap 100, Order no. 5804 712.005) in the Eppendorf Centrifuge 5810

Report No. 352-97 (Part 1)

Report prepared for: Eppendorf AG, Hamburg, Germany

Issue Date: Original report issued 8th September 1997

Certificate issued 18th October 2010

Test Summary

Rotor A-4-44 and sealed buckets and lids (Cap 100, Order no. 5804 712.005) were containment tested in the Eppendorf Centrifuge 5810, using Annex AA of IEC 1010-2-020. The sealed buckets were shown to contain the spill within the centrifuge.

Report Written By

Anna May

Report Authorised By

[Signature]

Health Protection Agency
Microbiological Services
Porton Down
Salisbury
Wiltshire SP4 0JG
United Kingdom



Certificate of Containment Testing

Containment Testing of Rotor A-4-62 and Sealed Buckets and Lids (Cap 250/1, Order no. 5810 710.006) in the Eppendorf Centrifuge 5810

Report No. 352-97 (Part 2)

Report prepared for: Eppendorf AG, Hamburg, Germany
Issue Date: Original report issued 8th September 1997
Certificate issued 18th October 2010

Test Summary

Rotor A-4-62 and sealed buckets and lids (Cap 250/1, Order no. 5810 710.006) were containment tested in the Eppendorf Centrifuge 5810, using Annex AA of IEC 1010-2-020. The sealed buckets were shown to contain the spill within the centrifuge.

Report Written By

Anna May

Report Authorised By

[Signature]

Certificate of Containment Testing

400ml Rectangular Buckets fitted with
Sealed Caps in Eppendorf Centrifuge 5810
containing Rotor A-4-81

Report No. 1000-06

Report prepared for: Eppendorf AG, Hamburg, Germany
Issue Date: 21st March 2006

Test Summary

400 ml rectangular buckets fitted with sealed caps were
containment tested in the Eppendorf centrifuge 5810
containing rotor A-4-81, using Annex AA of IEC 1010-2-20.
The buckets were shown to contain a large spill.

Report Written By



Report Authorised By





Certificate of Containment Testing

Containment Testing of Rotor FA-45-6-30 [(5820 715.103-00) and autoclaved lid (x50)] in the Eppendorf Centrifuge 5810R

Report No. 40-10B

Report prepared for: Eppendorf AG, Hamburg, Germany
Issue Date: 19th July 2010 (amended 17th Aug 10)

Test Summary

Rotor FA-45-6-30 (5820 715.103-00) and autoclaved lid (x50) was containment tested in the Eppendorf centrifuge 5810R, in accordance with Annex AA of IEC 1010-2-20. The sealed rotor was shown to contain the spill of micro-organisms and therefore prevent any release.

Report Written By

A blue ink signature written over a horizontal dashed line.

Report Authorised By

A blue ink signature written over a horizontal dashed line.



Certificate of Containment Testing

Containment Testing of Rotor FA-45-20-17 (5820 765.100-00) in the Eppendorf 5810/R Bench Top Centrifuge

Report No. 35/13

Report Prepared For: Eppendorf AG, Hamburg, Germany
Issue Date: 24th April 2013

Test Summary

Rotor FA-45-20-17 (5820 765.100-00) was containment tested in the Eppendorf 5810/R bench top centrifuge, using Annex AA of IEC 61010-2-020:2006 (2nd Ed.). The sealed rotor was shown to contain a spill within the centrifuge.

Report Written By

Name: Miss Anna Moy

Title: Biosafety Scientist

Report Authorised By

Name: Mrs Sara Speight

Title: Senior Biosafety Scientist



Certificate of Containment Testing

Containment Testing of Rotor FA-45-48-11(5820 760.109-00) in the Eppendorf 5810/R Bench Top Centrifuge

Report No. 199-12

Report Prepared For: Eppendorf AG, Hamburg, Germany

Issue Date: 12th September 2012

Test Summary

Rotor FA-45-48-11 (5820 760.109-00) was containment tested in the Eppendorf 5810/R bench top centrifuge, using Annex AA of IEC 1010-2-20. The sealed rotor was shown to contain a spill within the centrifuge

Report Written By

A handwritten signature in blue ink that reads "Anna Moy".

Name: Miss Anna Moy

Title: Biosafety Scientist

Report Authorised By

A handwritten signature in blue ink that reads "Sara Speight".

Name: Mrs Sara Speight

Title: Senior Biosafety Scientist



Certificate of Containment Testing

Containment Testing of Rotor S-4-104 with Round Buckets (5820 741.007-00) in the Eppendorf 5810/R Bench Top Centrifuge

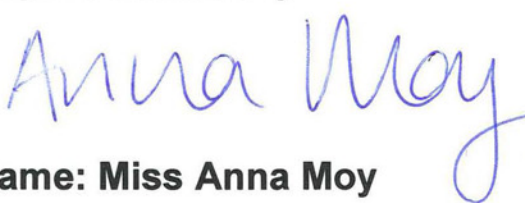
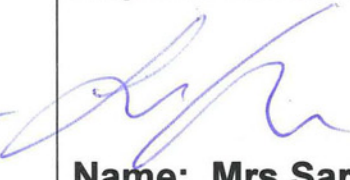
Report No. 196-12 A

Report Prepared For: Eppendorf AG, Hamburg, Germany

Issue Date: 12th September 2012

Test Summary

Rotor S-4-104 with Round Buckets (5820 741.007-00) was containment tested in the Eppendorf 5810/R bench top centrifuge, using Annex AA of IEC 1010-2-20. The sealed rotor was shown to contain a spill within the centrifuge

Report Written By  Name: Miss Anna Moy Title: Biosafety Scientist	Report Authorised By  Name: Mrs Sara Speight Title: Senior Biosafety Scientist
--	--



Certificate of Containment Testing

Containment Testing of Caps for Rotor S-4-104 with DWP- Buckets in the Eppendorf 5810/R Bench Top Centrifuge

Report No. 111/13 A

Report Prepared For: Eppendorf AG, Hamburg, Germany

Issue Date: 10th April 2014

Test Summary

Caps for rotor S-4-104 with DWP-Buckets were containment tested in the Eppendorf 5810/R bench top centrifuge, using Annex AA of IEC 61010-2-020:2006 (2nd Ed.). The sealed rotor was shown to contain a spill within the centrifuge.

Report Written By

Name: Miss Anna Moy

Title: Biosafety Scientist

Report Authorised By

Name: Mrs Sara Speight

Title: Senior Biosafety Scientist

Evaluate your manual

Give us your feedback.
www.eppendorf.com/manualfeedback