

Register your instrument!
www.eppendorf.com/myeppendorf



Centrifuge 5418 / 5418 R

Operating Manual

Copyright© 2013 Eppendorf AG, Hamburg. No part of this publication may be reproduced without the prior permission of the copyright owner.

Trademarks

Eppendorf® and the Eppendorf logo are registered trademarks of Eppendorf AG.

Microtainer® is a registered trademark of Becton Dickinson, Franklin Lakes, NJ, USA.

Trademarks are not marked in all cases with ™ or ® in this manual.

Table of contents

1	Operating instructions	5
1.1	Using this manual	5
1.2	Danger symbols and danger levels	5
1.2.1	Danger symbols	5
1.2.2	Danger levels	5
1.3	Symbols used	5
1.4	Abbreviations used	6
2	Product description	7
2.1	Main illustration	7
2.2	Delivery package	8
2.2.1	Centrifuge 5418	8
2.2.2	Centrifuge 5418 R	8
2.3	Features	9
2.4	Rotor FA-45-18-11	9
2.4.1	rcf display and calculation	10
3	Safety	11
3.1	Intended use	11
3.2	User profile	11
3.3	Application limits	11
3.3.1	Declaration concerning the ATEX directive (94/9/EC)	11
3.3.2	Maximum service life for accessories	11
3.4	Information on product liability	12
3.5	Warnings for intended use	12
3.5.1	Personal injury or damage to the equipment	12
3.5.2	Incorrect handling of the centrifuge	14
3.5.3	Incorrect handling of the rotors	14
3.5.4	Extreme strain on the centrifuging tubes	15
3.5.5	Aerosol-tight centrifugation	16
3.6	Safety instructions located on the device	16
4	Installation	17
4.1	Selecting the location	17
4.2	Preparing installation	17
4.3	Installing the instrument	18
5	Operation	19
5.1	Overview of operating controls	19
5.2	Preparing for centrifugation	20
5.2.1	Switching on the centrifuge	20
5.2.2	Inserting the rotor	20
5.2.3	Loading the rotor	21
5.2.4	Closing the rotor lid	21
5.2.5	Closing the centrifuge lid	22

Table of contents

Centrifuge 5418 / 5418 R
English (EN)

5.3	Cooling (only 5418 R)	22
5.3.1	Temperature adjustment	22
5.3.2	Temperature display	22
5.3.3	Temperature monitoring	22
5.3.4	FastTemp	23
5.3.5	Continuous cooling	23
5.4	Centrifuging	24
5.4.1	Centrifugation with time setting	24
5.4.2	Centrifuging in continuous operation	25
5.4.3	Short-spin centrifugation	25
5.4.4	Removing the rotor	26
5.5	Standby mode (only 5418)	26
5.6	Special functions (only 5418 R)	26
6	Maintenance	27
6.1	Prepare cleaning/disinfection	27
6.2	Cleaning/disinfection	27
6.2.1	Cleaning and disinfecting the device	28
6.2.2	Cleaning and disinfecting the rotor	28
6.3	Additional service instructions for Centrifuge 5418 R	29
6.4	Glass breakage	29
6.5	Fuses	30
6.6	Decontamination before shipment	30
7	Troubleshooting	31
7.1	General errors	31
7.2	Error messages	32
7.3	Emergency lid release	33
7.3.1	Centrifuge 5418	33
7.3.2	Centrifuge 5418 R	33
8	Transport, storage and disposal	35
8.1	Transport	35
8.2	Storage	35
8.3	Disposal	35
9	Technical data	37
9.1	Power supply	37
9.2	Ambient conditions	38
9.3	Weight/dimensions	38
9.4	Application parameters	39
10	Ordering information	41
10.1	Centrifuge 5418	41
10.2	Centrifuge 5418 R	41
10.3	Accessories	41
10.4	Fuses	42
10.4.1	Fuses for Centrifuge 5418	42
10.4.2	Fuses for Centrifuge 5418 R	42

1 Operating instructions







1.1 Using this manual

- ▶ Read this operating manual completely before using the device for the first time. Please also note the operating instructions for the accessories, if applicable.
- ▶ This operating manual is part of the product. Thus, it must always be easily accessible.
- ▶ Enclose this operating manual when transferring the device to third parties.
- ▶ If this manual is lost, please request another one. You will find the current version on our webpage www.eppendorf.com/worldwide.

1.2 Danger symbols and danger levels

The safety instructions in this manual appear with the following danger symbols and danger levels:

1.2.1 Danger symbols

	Biohazard		Explosion
	Electric shock		Crushing
	Hazard point		Material damage

1.2.2 Danger levels

DANGER	<i>Will</i> lead to severe injuries or death.
WARNING	<i>May</i> lead to severe injuries or death.
CAUTION	May lead to light to moderate injuries.
NOTICE	May lead to material damage.

1.3 Symbols used

Symbol	Meaning
▶	Handling
1. 2.	Actions in the specified order
•	List
<i>Text</i>	Name of fields in the software
	Useful information

1.4 Abbreviations used

PCR

Polymerase chain reaction

RZB/rcf

Relative centrifugal force – *g*-force in m/s^2

rpm

Revolutions per minute – in rpm

UV

Ultraviolet radiation

2 Product description

2.1 Main illustration

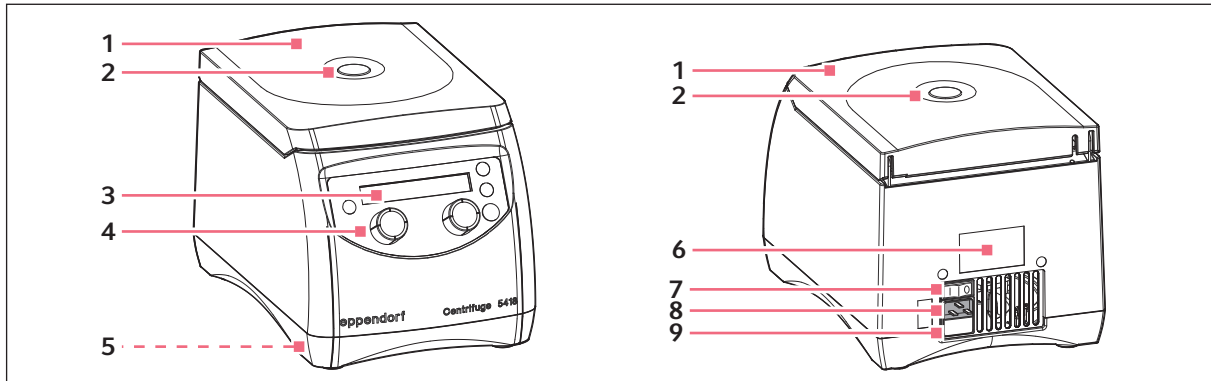

Fig. 2-1: Front and rear view of the Centrifuge 5418

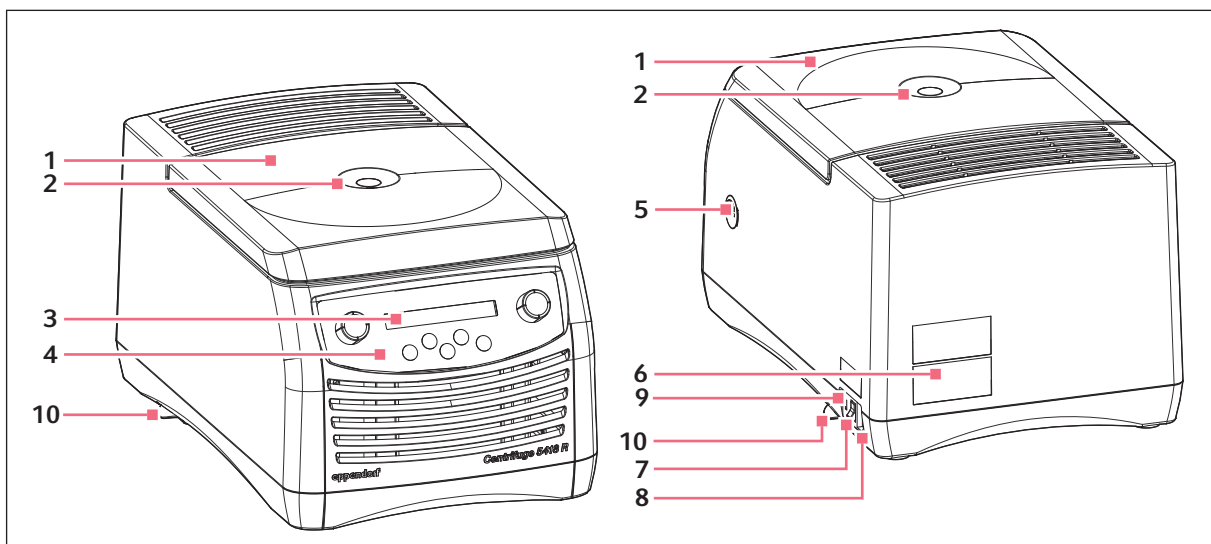

Fig. 2-2: Front and rear view of the Centrifuge 5418 R

- | | |
|---|---|
| <p>1 Centrifuge lid</p> <p>2 Monitoring glass
Visual control for rotor stop or speed control option using stroboscope</p> <p>3 Display
Depiction of the current centrifuging parameters and device settings.</p> <p>4 Control panel
For operating the centrifuge.</p> <p>5 Emergency lid release</p> | <p>6 Name plate</p> <p>7 Mains/power switch
Switch for switching the device on and off. Switch position 0: The device is switched off. Switch position I: The device is switched on.</p> <p>8 Mains connection
Connection socket for the mains cable supplied.</p> <p>9 Fuse holder</p> <p>10 Condensation water tray (only Centrifuge 5418 R)</p> |
|---|---|

Product description

Centrifuge 5418 / 5418 R
English (EN)

2.2 Delivery package

2.2.1 Centrifuge 5418

Quantity	Order no. (International)	Order no. (North America)	Description
1	-	-	Centrifuge 5418 See chapter <i>Ordering Information</i> for corresponding device version, equipment and order number
1 or	5425 351.003 5425 353.006	022668188 022668226	Fuse 2.5 A T (230 V), set of 2 5 A T (120 V), UL, set of 2
1	5416 301.001	022634305	Rotor key Standard
1	-	-	Power supply device
1 1	5401 900.022 5401 900.030	5401900022 5401900030	Operating manual Centrifuge 5418/5418 R Languages: EN, DE, FR, ES, IT, PT Languages: DA, FI, EL, NL, SV (230 V devices only)

2.2.2 Centrifuge 5418 R

Quantity	Order no. (International)	Order no. (North America)	Description
1	-	-	Centrifuge 5418 R See chapter <i>Ordering Information</i> for corresponding device version, equipment and order number
1 or	5425 351.003 5426 355.100	022668188 022668200	Fuse 2.5 A T (230 V), set of 2 6.25 AT (100 V/120 V), set of 2
1	5416 301.001	022634305	Rotor key Standard
1	5401 850.076	5401850076	Tray for condensation water
1	-	-	Power supply device
1 1	5401 900.022 5401 900.030	5401900022 5401900030	Operating manual Centrifuge 5418/5418 R Languages: EN, DE, FR, ES, IT, PT Languages: DA, FI, EL, NL, SV (230 V devices only)

2.3 Features

The compact and easy-to-use Centrifuge 5418 / 5418 R has a capacity of 18 x 2 ml and reaches a maximum of 16,873 x g / 14,000 rpm. The microcentrifuge is equipped with an aerosol-tight standard rotor for centrifugation of the following tubes:

- Micro test tubes (0.2 to 2.0 ml)
- Microtainers (0.6 ml)
- Spin columns (1.5/2.0 ml)

The Centrifuge 5418 R has an additional temperature control function for centrifugation between 0°C and +40°C. The **fast temp** function can be used to start a temperature control run without samples to adjust the rotor chamber incl. rotor and adapters quickly to the set target temperature.

2.4 Rotor FA-45-18-11

Before using tubes, observe the manufacturer's recommended specifications on resistance to centrifugation (max. g-force).

	Max. capacity	Max. g-force (rcf) or speed (rpm) without adapter	Max. load per rotor bore ⁽¹⁾	Notes
		Acceleration/deceleration time ⁽²⁾		
Rotor FA-45-18-11	18 micro test tubes of 1.5/ 2.0 ml each or spin columns. With adapters: • 0.2 mL PCR tubes • 0.4 ml/0.5 ml micro test tubes • 0.6 mL Microtainers	16,873 x g / 14,000 rpm	3.75 g	• Aerosol-tight ⁽³⁾ rotor lid (aluminum).
		5418: 16 s / 18 s 5418 R: 13 s / 13 s		

(1) Maximum load per rotor bore for adapter + tube + contents.

(2) According to DIN 58 970 (device version: 230 V, 50 to 60 Hz).

(3) Aerosol tightness tested and certified by the Centre of Emergency Preparedness and Response, Health Protection Agency, Porton Down (UK) (see certificates at the end of this operating manual).

Rotor code:

All Eppendorf® rotors are identified using a simple, alphanumeric format that represents the technical specifications in a uniform series of letters and numbers.

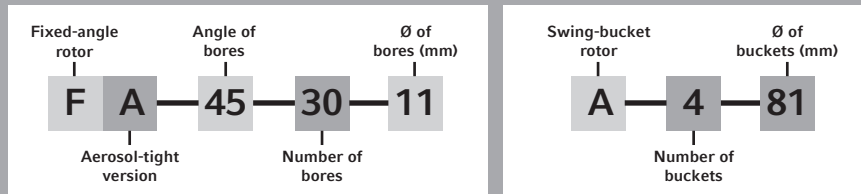

Product description

Centrifuge 5418 / 5418 R
English (EN)

2.4.1 rcf display and calculation



Use the **rpm/rcf** key to switch the display of centrifugation speed between rcf and rpm.
Only 5418 R: For speeds ≤ 800 rpm only the lowest adjustable g-force (100 x g) is displayed upon switching. The exact g-force (rcf) can be determined using the formula given below.

Ensure that the g-force (rcf) displayed upon switching is standardized to suit the rotor without an adapter. You can achieve the following maximum g-forces (rcf) at maximum speed (rpm) when adapters are used:

Adapter	Max. centrifugation radius r_{\max} [cm]	Max. g-force (rcf)
Without adapter	7.7	16,873
for 0.2 mL PCR tubes	5.6	12,271
for 0.4 mL micro test tubes	7.7	16,873
for 0.5 mL micro test tubes	6.6	14,462
for 0.6 mL Microtainers	7.7	16,873

To determine the g-force (rcf) for a special adapter, you can perform a calculation according to DIN 58 970 with the following formula:

$$\text{rcf} = 1.118 \cdot 10^{-5} \cdot n^2 \cdot r_{\max}$$

n: Revolutions per minute (rpm)

r_{\max} : Max. centrifugation radius in cm

Example:

The 0.2 ml adapter has a maximum radius of 5.6 cm. At 5,000 rpm a maximum g-force of 1,565 x g is reached.

3 Safety

3.1 Intended use

The Centrifuge 5418 / 5418 R is intended exclusively for indoor use and for separating aqueous solutions and suspensions of various densities in approved test tubes.

3.2 User profile

This device may only be operated by trained specialist staff. They must have carefully read the operating manual and be familiar with the function of the device.

3.3 Application limits

3.3.1 Declaration concerning the ATEX directive (94/9/EC)



DANGER! Risk of explosion.

- ▶ Do not operate the device in areas where work is completed with explosive substances.
 - ▶ Do not use this device to process any explosive or highly reactive substances.
 - ▶ Do not use this device for processing any substances which could generate an explosive atmosphere.
-

Due to its design and the environmental conditions inside the device, the Centrifuge 5418 / 5418 R is not suitable for use in a potentially explosive atmosphere.

The device only must be used in a safe environment, such as the open environment of a ventilated laboratory or fume hood. The use of substances which could create a potentially explosive atmosphere is not permitted. The final decision on the risks associated with the use of these types of substances is the responsibility of the user.

3.3.2 Maximum service life for accessories



WARNING! Risk of injury from chemically or mechanically damaged accessories.

Even minor scratches and cracks can lead to serious internal material damage.

- ▶ Protect all accessory parts from mechanical damage.
 - ▶ Inspect the accessories for damage before each use. Replace any damaged accessories.
 - ▶ Do not use rotors or rotor lids with signs of corrosion or mechanical damage (e.g. deformations).
 - ▶ Do not use any accessories which are past their use-by date.
-

SafetyCentrifuge 5418 / 5418 R
English (EN)

Accessories	Maximum service from the first commissioning onward
Rotor lid	3 years Requirement: The "click" is still audible when tightening the rotor lid screw.
Plastic adapters	1 year

For the rotor described there is no limit on the service life as long as the following prerequisites are met:

- Proper use,
- Recommended maintenance
- Undamaged condition

The date of manufacture is stamped on the rotors in the format *03/10* (= March 2010). This is for information only and does not have any reference to the service life.

To ensure aerosol tightness, the following applies:

- Replace aerosol-tight rotor lids and caps after 50 autoclaving cycles.
- Replace the seal of QuickLock rotor lids after 50 autoclaving cycles.

3.4 Information on product liability

In the following cases, the designated protection of the device may be compromised. Liability for any resulting property damage or personal injury is then transferred to the operator:

- The device is not used in accordance with the operating manual.
- The device is used outside of its intended use.
- The device is used with accessories or consumables which are not recommended by Eppendorf.
- The device is maintained or repaired by people not authorized by Eppendorf.
- The user makes unauthorized changes to the device.

3.5 Warnings for intended use

Read the operating manual and observe the following general safety instructions before using the Centrifuge 5418 / 5418 R.

3.5.1 Personal injury or damage to the equipment



WARNING! Electric shock due to damage to device or mains cable.

- ▶ Only switch on the device if the device and mains cable are undamaged.
- ▶ Only use devices that have been properly installed or repaired.
- ▶ In case of danger, disconnect the device from the mains supply by pulling the power plug from the device or the mains socket or, by using the isolating device intended for this purpose (e.g., emergency stop switch in the laboratory).



WARNING! Lethal voltages inside the device.

- ▶ Ensure that the housing is always closed and undamaged so that no parts inside the device can be contacted by accident.
- ▶ Do not remove the housing of the device.
- ▶ Do not allow any liquids to penetrate the inside of the housing.
- ▶ Do not allow the device to be opened by anyone except service personnel who have been specifically authorized by Eppendorf.



WARNING! Risk from incorrect supply voltage

- ▶ Only connect the device to voltage sources that match the electrical requirements listed on the name plate.
- ▶ Only use sockets with a protective earth (PE) conductor and suitable power cable.



WARNING! Damages to health due to infectious liquids and pathogenic germs.

- ▶ When handling infectious liquids and pathogenic germs, observe the national regulations, the biological security level of your laboratory, the material safety data sheets, and the manufacturer's application notes.
- ▶ Use aerosol tight sealing systems for the centrifugation of these substances.
- ▶ When working with pathogenic germs belonging to a higher risk group, more than one aerosol-tight bioseal must be used.
- ▶ Wear personal protective equipment.
- ▶ Consult the "Laboratory Biosafety Manual" (Source: World Health Organization, Laboratory Biosafety Manual, as amended) for comprehensive regulations on the handling of risk group II germs or biological materials).



WARNING! Crushing of the fingers with the centrifuge lid.

- ▶ When opening or closing the device lid, do not reach between the lid and device or into the latching mechanism of the lid.
- ▶ Always open the centrifuge lid completely to prevent it from falling.



CAUTION! Poor safety due to incorrect accessories and spare parts.

The use of accessories and spare parts other than those recommended by Eppendorf may impair the safety, functioning and precision of the device. Eppendorf cannot be held liable or accept any liability for damage resulting from the use of incorrect or non-recommended accessories and spare parts, or from the improper use of such equipment.

- ▶ Only use accessories and original spare parts recommended by Eppendorf.

**NOTICE! Damage to device due to spilled liquids.**

1. Switch the device off.
2. Disconnect the device from the power supply.
3. Carefully clean the device and the accessories in accordance with the cleaning and disinfection instructions in the operating manual.
4. If a different cleaning and disinfecting method is to be used, contact Eppendorf AG to ensure that the intended method will not damage the device.

**NOTICE! Damage to electronic components due to condensation.**

Condensation can form inside the device after the device has been moved from a cool to a warmer environment.

- ▶ 5418: Wait for at least 3 hours before connecting the device to the power supply.
- ▶ **Only 5418:** Alternative: Let the device heat up for 30 minutes right before a brief transport.
- ▶ 5418 R: Wait for at least 4 hours before connecting the device to the power supply.

3.5.2 Incorrect handling of the centrifuge

**NOTICE! Damage from knocking against or moving the device during operation.**

If the rotor bangs against the rotor chamber wall, it will cause considerable damage to the device and rotor.

- ▶ Do not move or knock against the device during operation.

3.5.3 Incorrect handling of the rotors

**WARNING! Risk of injury from improperly attached rotors and rotor lids.**

- ▶ Only centrifuge with rotor and rotor lid firmly tightened.
- ▶ If unusual noises occur when the centrifuge starts, the rotor or the rotor lid may not be properly secured. Immediately press the start/stop key to stop centrifuging.

**CAUTION! Risk of injury due to asymmetric loading of a rotor.**

- ▶ Load rotors symmetrically with identical tubes.
- ▶ Only load adapters with suitable tubes.
- ▶ Always use the same type of tubes (weight, material/density and volume).
- ▶ Check symmetric loading by balancing the adapters and tubes used with scales.

**CAUTION! Risk of injury from overloaded rotor.**

The Centrifuge 5418 / 5418 R is designed for the centrifugation of centrifugation material with a max. density of 1.2 g/mL at maximum speed and volume.

- ▶ Please note the information on each rotor on the maximum load (adapter, tube and contents) per rotor bore and do not exceed it.



NOTICE! Damage to rotors from aggressive chemicals.

Rotors are high-quality components which withstand extreme stresses. This stability can be impaired by aggressive chemicals.

- ▶ Avoid the use of aggressive chemicals, including strong and weak alkali, strong acids, solutions with mercury, copper and other heavy metal ions, halogenated hydrocarbons, concentrated saline solutions and phenol.
- ▶ Due to the manufacturing process, color variations may occur on rotors marked "coated". These color variations do not effect service life or resistance to chemicals.

3.5.4 Extreme strain on the centrifuging tubes



CAUTION! Risk of injury from overloaded tubes.

- ▶ Note the loading limits specified by the tube manufacturer.
- ▶ Only use tubes which are approved by the manufacturer for the required rcf.



NOTICE! Risk from damaged tubes.

Damaged tubes must not be used, as this could cause further damage to the device and the accessories and loss of the samples.

- ▶ Before use, visually check all of the tubes for damage.



NOTICE! Risk from open tube lids.

Open tube lids can break off during centrifugation and damage both the rotor and the centrifuge.

- ▶ Carefully seal all tube lids before centrifuging.



NOTICE! Hazard to plastic tubes from organic solvents.

The density of plastic tubes is reduced when organic solvents (e.g., phenol, chloroform) are used, i.e. the tubes could become damaged.

- ▶ Note the manufacturer's information on the chemical resistance of the tubes.



NOTICE! Sample tubes heat up.

In uncooled centrifuges, the temperature in the rotor chamber, rotor and sample can increase to above 40 °C, based on the run time, g-force (rcf)/speed and ambient temperature.

- ▶ Note that this can reduce the centrifugation resistance of the sample tubes.
- ▶ Please note the temperature resistance of the samples.

3.5.5 Aerosol-tight centrifugation

**WARNING! Risk to health due to limited aerosol tightness with incorrect rotor/rotor lid combination.**

Aerosol-tight centrifugation is guaranteed only if the rotors and rotor lids intended for this purpose are used. For fixed-angle rotors the labeling always begins with **FA**, swing-bucket rotors are labeled with **AT** (aerosol tight).

The aerosol-tight rotors and rotor lids of this centrifuge are additionally marked with a red ring on the rotor and a red rotor lid screw.

- ▶ For aerosol-tight centrifugation, always simultaneously use rotors and rotor lids which are marked as aerosol-tight in the centrifuge intended for the corresponding purpose. The details specifying in which centrifuge you may use the aerosol-tight rotors and rotor lids can be found on the rotor and, beginning from production date of October 2003, on the upper side of the rotor lid.
- ▶ Only use aerosol-tight rotor lids in combination with rotors which are marked on the rotor lid.

**WARNING! Health hazard from limited aerosol-tightness due to incorrect use.**

Autoclaving, mechanical stresses and contamination by chemicals or other aggressive solvents can impair the aerosol-tightness of the rotors and rotor lid.

- ▶ Check the integrity of the seals of the aerosol-tight rotor lids or caps before each use.
- ▶ Only use aerosol-tight rotor lids or caps if the seals are undamaged and clean.
- ▶ Thinly brush the threads of the rotor lid screw with pivot grease (order no. Int. 5810 350.050, North America 022634330). Do not apply the pivot grease to the seals.
- ▶ Replace aerosol-tight rotor lids and caps after 50 autoclaving cycles.
- ▶ For QuickLock rotor lids, the seal must be replaced after 50 autoclaving cycles.
- ▶ **Never** store aerosol-tight rotors or buckets closed.

3.6 Safety instructions located on the device

Display	Meaning	Location
	Follow the instructions in the operating manual.	5418: Rear of the device 5418 R: Right side of the device
ALWAYS FASTEN THE ROTOR SECURELY WITH THE SUPPLIED ROTOR KEY.	CAUTION Always tighten the rotor using the supplied rotor key.	Top of device, below the centrifuge lid
ALWAYS CLOSE TUBES! ALWAYS USE ROTOR LID WHEN USING SPIN COLUMNS!	CAUTION Close all tubes and use a rotor lid.	Top of device, below the centrifuge lid

4 Installation

4.1 Selecting the location



NOTICE! If an error occurs, the objects in the immediate proximity of the device will be damaged.

- ▶ In accordance with recommendations in EN 61010-2-020, leave a safety clearance of **30 cm** around the device during operation.
- ▶ Please remove all materials and objects from this area.



NOTICE! Damage from overheating.

- ▶ Do not install the device near to any heat sources (e.g., heating, drying cabinet).
- ▶ Do not expose the device to direct sunlight.
- ▶ Ensure unobstructed air circulation. Keep free a clearance of at least 33 cm around all ventilation grilles.

Select the location for the device according to the following criteria:

- Suitable power connection as per the name plate (230 V/120 V/100 V).
- Stable, horizontal and resonance-free lab bench. Weight of the device: 7.7 kg (5418) or 22 kg (5418 R).
- A well ventilated environment which is protected from direct sunlight to prevent the device from heating up more.

4.2 Preparing installation

Prerequisites

The weight of the Centrifuge 5418 is 7.7 kg or the Centrifuge 5418 R 22 kg. For unpacking and installing the Centrifuge 5418 R, you require the assistance of another person.

Perform the following steps in the sequence described.

1. Open the packaging board.
2. Remove the accessories.
3. Lift the Centrifuge 5418 / 5418 R out of the carton. Lift the Centrifuge 5418 R out of the carton with the help of another person.
4. Remove the front and back transport protection pads.
5. Place the device on a suitable lab bench.
6. Remove the plastic sleeve.

Installation

Centrifuge 5418 / 5418 R
English (EN)

4.3 Installing the instrument



NOTICE! Damage to electronic components due to condensation.

Condensation can form inside the device after the device has been moved from a cool to a warmer environment.

- ▶ 5418: Wait for at least 3 hours before connecting the device to the power supply.
- ▶ **Only 5418:** Alternative: Let the device heat up for 30 minutes right before a brief transport.
- ▶ 5418 R: Wait for at least 4 hours before connecting the device to the power supply.



NOTICE! Centrifuge 5418 R: compressor damage after improper transport.

- ▶ Only switch on the centrifuge 4 hours after installation.

Perform the following steps in the sequence described.

1. Let the device warm up to ambient temperature.
2. Check that the mains voltage and frequency match the requirements on the device type plate.
3. Connect the centrifuge to the mains and switch it on using the mains/power switch.
 - Display is active.
 - Lid opens automatically



4. Loosen and remove the rotor using the supplied rotor key.
5. Remove the transport protection pad from the motor shaft.
6. Use the details included in the scope of delivery to check that the delivery is complete.
7. Check all parts for any transport damage. Contact your dealer if any damage is found.
8. **Only 5418 R:** Insert the condensation water tray at the side of the device into the holder provided.



Retain the packaging material and the transport protection device for subsequent transport or storage. See also the instructions relating to transport.

5 Operation

5.1 Overview of operating controls

Familiarize yourself with the operating controls and the display before using the Centrifuge 5418 / 5418 R for the first time.

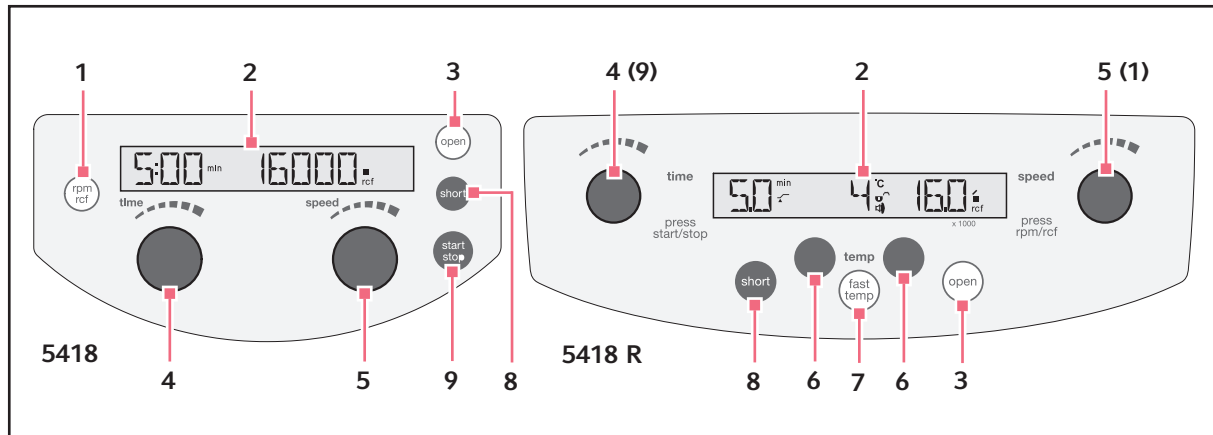

Fig. 5-1: Control panel of Centrifuge 5418 and Centrifuge 5418 R.

- | | |
|---|--|
| <p>1 Switch the displayed speed of centrifugation (rpm/rcf)</p> <p>2 Display</p> <p>3 Release lid</p> <p>4 Set centrifugation time
Only 5418 R: Press the time dial to start and stop centrifugation.</p> <p>5 Set speed of centrifugation
Only 5418 R: Press the speed dial to switch the displayed centrifugation speed (rpm/rcf).</p> | <p>6 Adjust temperature (only 5418 R)</p> <p>7 Start the temperature control run fast temp (only 5418 R)</p> <p>8 Short-spin centrifugation</p> <p>9 Start and stop centrifugation</p> |
|---|--|

Operation

Centrifuge 5418 / 5418 R
English (EN)

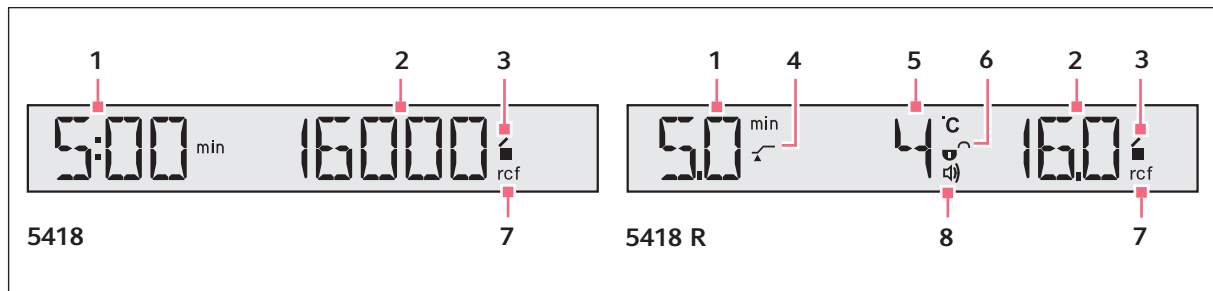

Fig. 5-2: Display of Centrifuge 5418 and Centrifuge 5418 R.

- | | |
|--|---|
| <p>1 Centrifugation time</p> <p>2 g-force (rcf) / speed (rpm)
5418 R: Set value x 1000</p> <p>3 Status of centrifuge
 : Centrifuge lid unlocked.
 : Centrifuge lid locked.
 (Flashing): Centrifuging in progress.</p> <p>4 At set rpm (only 5418 R)
 : Start of run time when reaching 95% of the preset g-force (rcf) / speed (rpm).
 : Immediate start of run time.</p> | <p>5 Temperature (only 5418 R)</p> <p>6 Status of the key lock (only 5418 R)
 : Centrifuging parameters cannot be modified unintentionally.
 : No key lock.</p> <p>7 Status of centrifugation speed display
 rcf: g-force (relative centrifugal force, RCF)
 rpm: speed (revolutions per minute)</p> <p>8 Status of the loudspeaker (only 5418 R)
 : Switched on.
 No symbol: Switched off.</p> |
|--|---|

5.2 Preparing for centrifugation

5.2.1 Switching on the centrifuge

- Switch on the centrifuge using the mains switch.
The centrifuge lid opens automatically after switching on using the mains switch.
- Open the closed centrifuge lid by pressing the **open** key.
The parameter settings of the last run are displayed.

5.2.2 Inserting the rotor



NOTICE! If handled incorrectly, the rotor can fall over.

The rotor lid screw may become loose if it is used to retain the rotor.

- ▶ Always grasp the rotor with both hands for holding or transport.

- Place the rotor on the motor shaft.
- Insert the delivered rotor key in the rotor nut.
- Turn rotor key **clockwise** until the rotor nut is firmly tightened.

5.2.3 Loading the rotor



CAUTION! Risk of injury due to asymmetric loading of a rotor.

- ▶ Load rotors symmetrically with identical tubes.
- ▶ Only load adapters with suitable tubes.
- ▶ Always use the same type of tubes (weight, material/density and volume).
- ▶ Check symmetric loading by balancing the adapters and tubes used with scales.



CAUTION! Risk from damaged or overloaded tubes.

- ▶ When loading the rotor, observe the safety precautions on dangers as a result of overloaded or damaged tubes (see *Warnings for intended use on p. 12*).

To load the rotor, proceed as follows:

1. Check the maximum load (adapter, tube and contents) per rotor bore.
The maximum load is 3.75 g per rotor bore. This information can also be found on the rotor.
2. Load rotors and adapters only with the tubes intended for them.
3. Insert tubes opposite each other in pairs into the rotor bores. For symmetric loading, tubes that face each other must be the same type and have the same filling quantity.

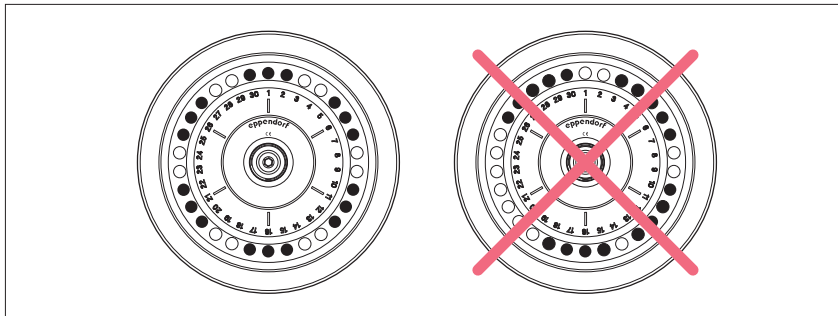

To keep the weight differences between the filled tubes low, we recommend taring with a balance. This is gentle on the drive and reduces the operating noises.

5.2.4 Closing the rotor lid



With the rotor FA-45-18-11 centrifugation is also possible without a rotor lid.

Please also note:

- The tube lids must be closed securely.
- Without the rotor lid, the rotor is not aerosol-tight.
- The centrifugation is slightly louder.
- Spin columns must always be centrifuged with a rotor lid.

Operation

Centrifuge 5418 / 5418 R
English (EN)

1. Check to see if the outer sealing ring is correctly positioned in the groove.
2. Fit the rotor lid vertically onto the rotor.
3. Lock the rotor by turning the red rotor lid screw clockwise beyond an audible *click* until it can be turned no further.

The rotor is correctly locked after the audible "click" is heard!

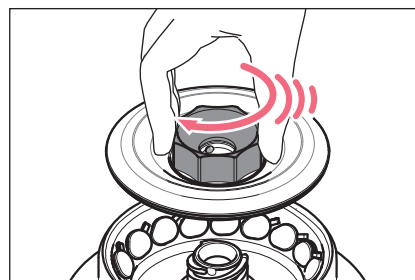

5.2.5 Closing the centrifuge lid



WARNING! Crushing of the fingers with the centrifuge lid.

- ▶ When opening or closing the device lid, do not reach between the lid and device or into the latching mechanism of the lid.
- ▶ Always open the centrifuge lid completely to prevent it from falling.

1. Check correct attachment of rotor and rotor lid.
2. Push down the centrifuge lid until the lid latch engages and the lid is automatically closed.

The centrifuge will close automatically.

The display shows the ■ symbol.

Only 5418: The **open** key lights blue.

5.3 Cooling (only 5418 R)

5.3.1 Temperature adjustment

- ▶ Set the temperature using the **temp** arrow keys from 0°C to +40°C.

5.3.2 Temperature display

If the rotor is stopped:

Set temperature

During centrifugation:

Actual temperature

5.3.3 Temperature monitoring

After the set temperature has been reached the centrifuge responds as follows to temperature fluctuations during centrifugation:

Deviation from the target value	Action
$\Delta T > 3^{\circ}\text{C}$	Temperature display flashes.
$\Delta T > 5^{\circ}\text{C}$	Periodic warning tone and display Error 18 . Centrifugation is stopped automatically.

5.3.4 FastTemp

This function can be used to start a temperature control run directly without samples with a rotor and temperature-specific speed in order to quickly adjust the rotor chamber, incl. rotor and adapters, up to the set target temperature.

Prerequisites

- The centrifuge is switched on.
- Rotor and rotor lid are correctly mounted.
- The centrifuge lid is closed.
- The temperature and g-force (rcf) or speed (rpm) are set for the subsequent centrifugation (see *Centrifuging on p. 24*).

1. Press the **fast temp** key.

The display shows **FT** as well as the current temperature and g-force (rcf) or speed (rpm).

The cooling time from room temperature ($\approx 23\text{ }^{\circ}\text{C}$) to $4\text{ }^{\circ}\text{C}$ takes Approx. 16 min.

The temperature control cycle ends automatically when the target temperature has been reached. A periodic signal tone sounds.

2. Press the **start/stop** key to end the temperature control run early.

After the set temperature has been reached and the temperature control run is complete, the centrifuge keeps the rotor chamber, with the centrifuge lid closed, at the set temperature, if the temperature is below the ambient temperature. Irrespective of the target temperature, however, this continuous cooling does not go below $4\text{ }^{\circ}\text{C}$ to prevent the rotor chamber from freezing.



The centrifuge stops the run automatically when the rotor has reached the set temperature. Therefore, there may be a delay between the display of the achieved set temperature and the automatic end of the temperature control run.

5.3.5 Continuous cooling

When the rotor is stopped the rotor chamber is kept at the target temperature when the following prerequisites are met:

- The centrifuge is switched on.
- The centrifuge lid is closed.
- The target temperature is below the ambient temperature.

During continuous cooling the following applies:

- The target temperature is displayed.
- Irrespective of the target temperature, continuous cooling does not go below $4\text{ }^{\circ}\text{C}$ to prevent the rotor chamber and the samples from freezing and increased condensation in the device.
- The temperature adjustment takes longer because the rotor is not rotating.

Open the centrifuge lid to end continuous cooling.

If the centrifuge is not used for more than 8 hours, the continuous cooling is switched off automatically. This protects against ice formation in the rotor chamber and the tubes, and against increased condensation in the device.

The display shows the actual temperature of the rotor chamber.

With **fast temp** you can quickly reach the desired temperature again (see p. 23).

5.4 Centrifuging



CAUTION! Risk from incorrectly-loaded rotors and damaged/overloaded tubes!

- ▶ Before commencing centrifugation, follow the safety instructions relating to risks from asymmetrically loaded and/or overloaded rotors and from overloaded, damaged and/or open tubes (see *Warnings for intended use on p. 12*).



WARNING! Risk of injury from improperly attached rotors and rotor lids.

- ▶ Only centrifuge with rotor and rotor lid firmly tightened.
- ▶ If unusual noises occur when the centrifuge starts, the rotor or the rotor lid may not be properly secured. Immediately press the start/stop key to stop centrifuging.

Before using the Centrifuge 5418 / 5418 R for the first time, familiarize yourself with the operating controls and the display (see *Overview of operating controls on p. 19*).

Each of the centrifuging variants described here must be preceded by the preparation described above (see *Preparing for centrifugation on p. 20*).

Only 5418 R: Please also note the instructions on cooling (see p. 22).

5.4.1 Centrifugation with time setting

Perform the following steps in the sequence described.

1. Use **time** to set the run time.
2. **Only 5418 R:** Use **temp** to set the temperature.
3. Use **speed** to set the g-force (rcf) or speed (rpm).
4. Press **start/stop** to start centrifuging.

During centrifugation:

- In the display ■ flashes while the rotor is running.
- **Only 5418 R:** The current temperature will be displayed.
- The **fast temp** (only 5418 R), **open** and **short** keys are blocked during centrifugation.
- During the run you can modify the total run time, the temperature (only 5418 R), the speed and the rpm/rcf display. **Only 5418 R:** To change the centrifugation parameters, press the **short** key first. The values flash in the display during the change. The new parameters are adopted immediately. When the time is changed during a run, the time which has already elapsed is taken into account. Please note that the shortest new total run time that can be set is the elapsed time plus 2 minutes.
- You can also terminate the centrifugation before the set run time has elapsed by pressing the **start/stop** key.

End of centrifugation

- The centrifuge automatically stops after the set time has elapsed. The elapsed centrifugation will be shown in a blinking display during the braking process. A signal tone sounds when the rotor is at a standstill.
- **Only 5418:** The centrifuge lid opens automatically. The display shows the symbol .
- **Only 5418 R:** The centrifuge lid remains closed to maintain the sample temperature. You can open it by pressing the **open** key.

5. Remove the material for centrifuging.

5.4.2 Centrifuging in continuous operation

Perform the following steps in the sequence described.

1. Use **time** to set the continuous run.

The continuous run function can be set above 9:59 h or under 30 s (5418) or above 99 min or under 0.5 min (5418 R). The timer shows **oo** to indicate continuous operation.

2. **Only 5418 R:** Use the **temp** arrow keys to adjust the temperature.

3. Use **speed** to set the g-force (rcf) or speed (rpm).

4. Press **start/stop** to start centrifuging.

In the display  flashes while the rotor is running.

Time is counted upwards, first in 30-second increments and then in minute increments from ten minutes.

5. Press **start/stop** to end centrifuging after the desired time period.

- The centrifugation time will be shown in a blinking display during the braking process.
- A signal tone sounds when the rotor is at a standstill.
- **Only 5418:** The centrifuge lid opens automatically. The display shows the symbol .
- **Only 5418 R:** The centrifuge lid remains closed to maintain the sample temperature. You can open it by pressing the **open** key.

6. Remove the material for centrifuging.

5.4.3 Short-spin centrifugation

5418: You can carry out a short run with the maximum g-force (rcf) / speed (rpm).

5418 R: You can carry out a short run with the currently set or with the maximum g-force (rcf) / speed (rpm). Set this short spin mode as described in the following section.

5.4.3.1 Selecting short spin mode (only 5418 R)

1. Press the **short** key while the centrifuge lid is open.

The current mode is displayed:

- Display **1 – 14 t** (run at preselected speed)
- Display **14 t** (run at maximum speed of 14.000 rpm)

2. When the centrifuge lid is open, press the **short** key for longer than 2 s to switch between these modes.

Operation

Centrifuge 5418 / 5418 R
English (EN)

5.4.3.2 Performing short spin centrifugation

1. **Only 5418 R:** A short run at preselected g-force (rcf) or speed (rpm) can be set directly using the **speed** dial.
2. **Only 5418 R:** Use the **temp** arrow keys to adjust the temperature.
3. Start short run: Hold down the **short** key.
 - In the display ■ flashes while the rotor is running.
 - The time is counted upwards in seconds.
 - During short run centrifuging all other keys are blocked.
4. End short run: Release the **short** key.
 - The centrifugation time will be shown in a blinking display during the braking process.
 - **Only 5418:** The centrifuge lid opens automatically. The display shows the symbol .
 - **Only 5418 R:** The centrifuge lid remains closed to maintain the sample temperature. You can open it by pressing the **open** key.
5. Remove the material for centrifuging.



During the braking process, you can restart the centrifugation up to two times by pressing the **short** key again.



5.4.4 Removing the rotor

1. Turn the rotor nut **counterclockwise** using the supplied rotor key.
2. Remove the rotor vertically in an upward motion.
3. **Only 5418 R:** Switch off the centrifuge after use and empty the condensation water tray (pull out from the left or right side of the device). Leave the centrifuge lid fully open and secure it against closing.

5.5 Standby mode (only 5418)

If the centrifuge has not been used for 15 min, it switches to standby mode. The **EP** logo then appears in the display. When a button or knob is used or the centrifuge lid is closed, the centrifuge is reactivated and ready for operation.

5.6 Special functions (only 5418 R)

Function	Status of centrifuge lid	Press > 2 s key	Display
Modify parameter during the cycle.	■ closed	short key	Flashes 5 s
Enable/disable signal tone.	🔊 open	open	
Enable/disable key lock.	🔒 open	short + open	
At set rpm	🕒 open	time	

6 Maintenance

6.1 Prepare cleaning/disinfection

The procedure described in the following chapter applies to the cleaning as well as to the disinfection or decontamination. The table below describes the steps required on top of this:

Cleaning	Disinfecting/decontamination
<ol style="list-style-type: none"> 1. Use a mild cleaning fluid to clean the accessible surfaces of the device and the accessories. 2. Carry out the cleaning as described in the following chapter. 	<ol style="list-style-type: none"> 1. Choose the disinfection method which corresponds to the legal regulations and guidelines in place for your range of application. For example, use alcohol (ethanol, isopropanol) or alcohol-based disinfectants. 2. Carry out the disinfection or decontamination as described in the following chapter. 3. Then clean the device and the accessories.



If you have any further questions regarding the cleaning and disinfection or decontamination or regarding the cleaning fluid to be used, contact the Eppendorf AG Application Support. The contact details are provided on the back of this manual.

6.2 Cleaning/disinfection



DANGER! Electric shock as a result of penetration of liquid.

- ▶ Switch off the device and disconnect the power plug before starting cleaning or disinfection work.
- ▶ Do not allow any liquids to penetrate the inside of the housing.
- ▶ Do not spray clean/spray disinfect the housing.
- ▶ Only plug the device back in if it is completely dry, both inside and outside.



NOTICE! Damage from the use of aggressive chemicals.

- ▶ Do not use any aggressive chemicals on the device or its accessories, such as strong and weak bases, strong acids, acetone, formaldehyde, halogenated hydrocarbons or phenol.
- ▶ If the device has been contaminated by aggressive chemicals, immediately clean it by means of a mild cleaning agent.



NOTICE! Corrosion from aggressive cleaning agents and disinfectants.

- ▶ Do not use corrosive cleaning agents, aggressive solvents or abrasive polishes.
- ▶ Do not incubate the accessories in aggressive cleaning agents or disinfectants for a longer period of time.

**NOTICE! Damage from UV and other high-energy radiation.**

- ▶ Do not use UV, beta, gamma, or any other high-energy radiation for disinfecting.
- ▶ Avoid storage in areas with strong UV radiation

**Autoclaving**

Rotors, rotor lids and adapters can be autoclaved (121 °C, 20 min).

Replace the sealing ring in the lid groove of the aerosol-tight rotor lid after a maximum of 50 autoclaving cycles.

**Aerosol tightness**

Check that the seals are intact before use.

Only QuickLock rotor lid: Replace the sealing ring in the lid groove when it becomes worn.

The sealing rings require regular care to protect the rotors.

Aerosol-tight rotors should never be stored with lids screwed on!

In order to prevent damage, lightly lubricate the lid thread of the aerosol-tight rotors with pivot grease (order no. Int.: 5810 350.050/North America: 022634330).

6.2.1 Cleaning and disinfecting the device

1. Open the lid. Switch off the device with the mains/power switch. Disconnect the power plug from the power supply.
2. Loosen the rotor nut by turning the rotor key **counterclockwise**.
3. Remove the rotor.
4. Clean and disinfect all accessible surfaces of the device, including the power cable, using a damp cloth and the recommended cleaning agents.
5. Thoroughly clean the rubber seals of the rotor chamber with water.
6. Rub the dry rubber seals with glycerine or talcum powder to prevent them from becoming brittle. Other components of the device, such as the lid latch, motor shaft and rotor cone, must not be lubricated.
7. Clean the motor shaft with a soft, dry and lint-free cloth. Do not lubricate the motor shaft.
8. Check the motor shaft for damage.
9. Inspect the device for corrosion and damage.
10. Leave the centrifuge lid open when the device is not being used.
11. Only connect the device to the power supply if it is fully dry inside and out.

6.2.2 Cleaning and disinfecting the rotor

1. Inspect the rotor and accessories for damage and corrosion. Do not use any damaged rotors or accessories.
2. Clean and disinfect the rotors and accessories with the recommended cleaning agents.
3. Use a bottle brush to clean and disinfect the rotor bores.
4. Remove the sealing ring to clean and disinfect the rotor lid. Clean the groove below it and the sealing ring.

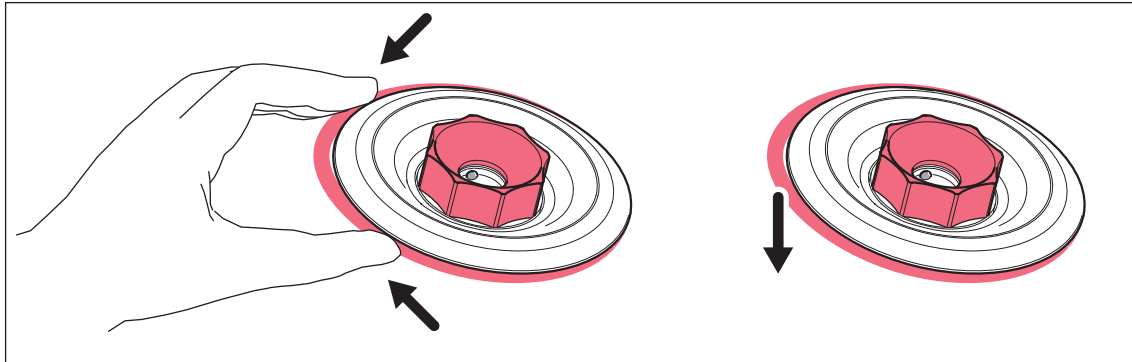

5. Rinse the rotors and accessories thoroughly with distilled water. Rinse the rotor bores of fixed-angle rotors particularly thoroughly.



Do not immerse the rotor in liquid as liquid can get trapped inside the cavities.

6. Place rotors and accessories on a cloth to dry. Place fixed-angle rotors with the rotor bores facing downwards to allow the bores to also dry.
7. Correctly reinsert the rotor lid sealing ring in the clean and dry groove.
8. Clean the rotor cone with a soft, dry and lint-free cloth. Do not lubricate the rotor cone.
9. Inspect the rotor cone for damage.
10. Place the dry rotor onto the motor shaft.
11. Tighten the rotor nut firmly by turning it **clockwise** with the rotor key.
12. Leave the rotor lid open when the rotor is not being used.

6.3 Additional service instructions for Centrifuge 5418 R

- ▶ Empty and clean the condensation water tray regularly and especially after liquid spillage in the rotor chamber. Pull out the condensation water tray from the left or right side of the centrifuge.
- ▶ Regularly free the rotor chamber ice formations via thawing, by leaving the centrifuge lid open or carrying out a short temperature control run at approx. 30 °C.
- ▶ Leave the centrifuge lid open when not in use for a long period.
- ▶ Wipe up condensate in the rotor chamber using a soft, absorbent cloth.
- ▶ Remove dust deposits from the ventilation slits of the centrifuge using a brush or swab at the latest every six months. First switch off the device and remove the power plug.

6.4 Glass breakage

When using glass tubes there is a risk of glass breakage in the rotor chamber. The resulting glass splinters are swirled around in the rotor chamber during centrifugation and have a sandblasting effect on the rotor and accessories. The smallest glass particles become lodged in the rubber parts (e.g., the motor guide, the rotor chamber gasket, and the rubber mats of adapters).

**NOTICE! Glass breakage in the rotor chamber**

Glass tubes in the rotor chamber may break if the g -force is too high. Broken glass can damage the rotor, accessories and samples.

- ▶ Please note the manufacturer's information on the recommended centrifugation parameters (load and speed).
-

Effects of glass breakage in the rotor chamber:

- Fine black metal abrasion in the rotor chamber (in metal rotor chambers)
- The surfaces of the rotor chamber and accessories are scratched.
- The chemical resistance of the rotor chamber is reduced.
- Contamination of samples
- Wear on rubber parts

How to proceed in case of glass breakage

1. Remove all splinters and glass powder from the rotor chamber and accessories.
2. Thoroughly clean the rotor and rotor chamber. Thoroughly clean the bores of the fixed-angle rotors, in particular.
3. If required, replace the adapters to prevent any further damage.
4. Regularly check the rotor bores for deposits and damage.

6.5 Fuses

The fuse holder is located under the mains power socket (5418) or on the left next to the mains switch (5418 R).

1. Disconnect the mains plug.
2. Remove the fuse holder.

Both fuses are now accessible and can be replaced.

6.6 Decontamination before shipment

If you are shipping the device to the authorized Technical Service for repairs or to your authorized dealer for disposal please note the following:

**WARNING! Risk to health from contaminated device**

1. Observe the notes on the decontamination certificate. You find it as a PDF file on our website (www.eppendorf.com/decontamination).
 2. Decontaminate all the parts you would like to dispatch.
 3. Include the fully completed decontamination certificate in the package.
-

7 Troubleshooting

If you cannot remedy an error with the recommended measures, please contact your local Eppendorf partner. The contact address can be found online at: www.eppendorf.com/worldwide.

7.1 General errors

Symptom/message	Cause	Remedy
No display.	No power connection.	▶ Check mains/power connection.
No display.	Power failure.	▶ Check the mains fuse of the device (see <i>Fuses on p. 30</i>). ▶ Check the mains fuse of the laboratory.
Lid of the device cannot be opened.	Rotor is still running.	▶ Wait for rotor to stop.
Lid of the device cannot be opened.	Power failure.	1. Check the mains fuse of the device (see <i>Fuses on p. 30</i>). 2. Check the mains fuse of the laboratory. 3. Activate the emergency lid release (see p. 33).
Device cannot be started.	Lid of the device is not closed.	▶ Close device lid.
Device shakes when it starts up.	Rotor loaded unsymmetrically.	1. Stop the device and load symmetrically. 2. Restart device.
Centrifuge brakes during a short run centrifugation, although the short key is pressed.	The short key was released briefly more than twice (protective function for the drive).	▶ Press the short key continuously during a short run centrifugation.
Temperature display flashes. (only for 5418 R)	Temperature deviation from the set value: ± 3 °C.	▶ Check the settings. ▶ Wait until the set temperature has been reached. ▶ Check unhindered air circulation through the air slots. ▶ Thaw ice or switch off device and allow it to cool down.

7.2 Error messages

If one of the following error messages appears, proceed as follows:

1. Remove fault (see Remedies).
2. If necessary, repeat centrifugation.

Symptom/message	Cause	Remedy
LID ERROR (5418)/ LID (5418 R)	Centrifuge lid cannot be locked.	▶ Try again to close centrifuge lid.
LID ERROR (5418)/ LID (5418 R)	Centrifuge lid cannot be released.	1. Switch the centrifuge off and back on. 2. Press the open key. If the error occurs again: 1. Switch off centrifuge. 2. Activate the emergency lid release (see <i>Emergency lid release on p. 33</i>).
LID ERROR (5418)/ LID (5418 R)	Centrifuge lid must not be released during a run.	▶ Wait for rotor to stop.
INT	Mains/power failure during a run.	▶ Check the mains connection.
NO RPM (5418)/ Error 3 (5418 R)	Error in the speed measuring system or drive overheated.	▶ Leave the device switched on until the error message disappears (10 s or 6 min).
Error 5 (only for 5418 R)	Prohibited opening of lid or lid switch is defective during a run.	1. Wait for rotor to stop. 2. Open and close again the lid of the device. 3. Repeat the run.
Err 6 (5418)/ Error 6 (5418 R)	Drive fault.	▶ Repeat the run. ▶ If this error message appears again, switch centrifuge off and back on again after > 20 s.
Error 6 (only for 5418 R)	Drive overheated.	▶ Allow the drive to cool down for at least 15 min.
Err 7 (5418)/ Error 7 (5418 R)	Major deviation in the speed control.	1. Wait for rotor to stop. 2. Tighten rotor.
Err 8 (5418)/ Error 8 (5418 R)	Drive fault.	1. Wait for rotor to stop. 2. Repeat the run.
Err 9 to 17 (5418)/ Error 9 to 17 (5418 R)	Electronics error.	▶ Switch centrifuge off and back on again after > 20 s.
Error 18 (only for 5418 R)	Too high temperature deviation from set value in the rotor chamber.	▶ Check the settings. ▶ Check unhindered air circulation through the air slots. ▶ Thaw ice or switch off device and allow it to cool down.

Symptom/message	Cause	Remedy
Error 19 (only for 5418 R)	Cooling circuit is overheated.	▶ Check unhindered air circulation through the air slots and allow device to cool down.
Error 20 (only for 5418 R)	Temperature sensor in rotor chamber is faulty.	▶ Switch centrifuge off and back on again after > 20 s.
Error 21 (only for 5418 R)	Temperature sensor on condenser is faulty.	▶ Switch centrifuge off and back on again after > 20 s.
Error 24 (only for 5418 R)	Cooling unit fault, e.g. overheated.	▶ Allow the centrifuge to cool down and repeat the run.

7.3 Emergency lid release

If the centrifuge lid cannot be opened, the emergency lid release can be operated manually.



WARNING! Risk of injury from rotating rotor.

- ▶ Wait until the rotor has come to a standstill before you operate the emergency release.
- ▶ To check, look through the inspection glass in the centrifuge lid.

7.3.1 Centrifuge 5418

1. Disconnect the mains plug.
2. Open the plastic cover of the emergency lid release.
This is located behind the front left device foot in the base plate (Fig. 2-1 on p. 7).
3. Pull the cord vertically downwards.
The centrifuge lid is unlocked.
4. Before closing the centrifuge lid again: push the cord completely into the housing and insert the plastic cover in the base plate.

7.3.2 Centrifuge 5418 R

1. Disconnect the mains plug.
2. Turn the plastic cover of the emergency lid release anti-clockwise by 90° with a suitable tool (e.g. screwdriver), and remove it.
The plastic cover is located on the right side of the device (Fig. 2-2 on p. 7).
3. Insert the centrifuge rotor key into the hexagonal opening at rear until some resistance can be felt.
4. **Press the rotor key slightly down**, and turn it clockwise.
This will release the centrifuge lid.
5. Open the centrifuge lid.
6. Remove the rotor key and put the plastic cover back on rotating it 90° clockwise.

Troubleshooting

Centrifuge 5418 / 5418 R
English (EN)

8 Transport, storage and disposal

8.1 Transport



CAUTION! Bodily injury due to lifting and carrying heavy loads

The device is heavy. Lifting and carrying the device can lead to back injuries.

- ▶ The device must be transported by least two people.
- ▶ Use a transport aid (e.g., dolly) to transport the device longer distances.

- ▶ Remove the rotor from the centrifuge before transport.
- ▶ Use the original packaging for transport.

	Air temperature	Relative humidity	Atmospheric pressure
General transport	-25 °C – 60 °C	10 % – 75 %	30 kPa – 106 kPa
Air freight	-20 °C – 55 °C	10 % – 75 %	30 kPa – 106 kPa

8.2 Storage

	Air temperature	Relative humidity	Atmospheric pressure
In transport packaging	-25 °C – 55 °C	10 % – 75 %	70 kPa – 106 kPa
Without transport packaging	-5 °C – 45 °C	10 % – 75 %	70 kPa – 106 kPa

8.3 Disposal

In case the product is to be disposed of, the relevant legal regulations are to be observed.

Information on the disposal of electrical and electronic devices in the European Community:

Within the European Community, the disposal of electrical devices is regulated by national regulations based on EU Directive 2002/96/EC pertaining to waste electrical and electronic equipment (WEEE).

According to these regulations, any devices supplied after August 13, 2005, in the business-to-business sphere, to which this product is assigned, may no longer be disposed of in municipal or domestic waste. To document this, they have been marked with the following identification:



Because disposal regulations may differ from one country to another within the EU, please contact your supplier if necessary.

9 Technical data

9.1 Power supply

Centrifuge 5418

Mains connection	230 V, 50 Hz – 60 Hz 120 V, 50 Hz – 60 Hz 100 V, 50 Hz – 60 Hz
Current consumption	1.4 A (230 V) 2.8 A (120 V) 3.4 A (100 V)
Power consumption	Maximum 170 W
EMC: Interference emission. (radio interference)	EN 61326 – Class B (230 V) FCC15 - Class A (120 V/100 V)
EMC: Noise immunity	EN 61326
Overvoltage category	II
Fuses	2.5 AT (230 V) 5.0 AT (120 V / 100 V)
Degree of pollution	2

Centrifuge 5418 R

Mains connection	230 V, 50 Hz – 60 Hz 120 V, 50 Hz – 60 Hz 100 V, 50 Hz – 60 Hz
Current consumption	1.4 A (230 V) 2.8 A (120 V) 3.0 A (100 V)
Power consumption	Maximum 320 W
EMC: Interference emission. (radio interference)	EN 61326 – Class B (230 V) FCC15 - Class A (120 V/100 V)
EMC: Noise immunity	EN 61326
Overvoltage category	II
Fuses	2.5 AT (230 V) 6.25 AT (120 V / 100 V)
Degree of pollution	2

Technical dataCentrifuge 5418 / 5418 R
English (EN)

9.2 Ambient conditions

Environment:	Only for use indoors.
Ambient temperature:	Centrifuge 5418: 2 °C to 40 °C Centrifuge 5418 R: 15 °C to 35 °C
Max. relative humidity:	75 %, non-condensing humidity.
Atmospheric pressure:	Use up to an altitude of 2 000 m above MSL.
Degree of pollution:	2

9.3 Weight/dimensions

Tab. 9-1: Centrifuge 5418

Dimensions:	Width: 208 cm (8.19 in) Depth: 300 cm (11.8 in) Height: 210 cm (8.27 in)
Weight without rotor:	7.7 kg
Noise level:	< 51 dB (A) *

Tab. 9-2: Centrifuge 5418 R

Dimensions:	Width: 298 cm (11.73 in) Depth: 463 cm (18.23 in) Height: 463 cm (18.23 in)
Weight without rotor:	22 kg
Noise level:	< 57 dB (A) *

*) The noise level was measured according to DIN EN ISO 3745 frontally in a sound measuring room with accuracy class 1 at a distance of 1 m from the device and at lab bench height.

9.4 Application parameters

Start and stop times according to DIN 58 970

Rotor	5418			5418 R		
	Voltage	Acceleration times	Deceleration times	Voltage	Acceleration times	Deceleration times
FA-45-18-11	230 V	16 s	18 s	230 V	13 s	13 s
	120 V	16 s	18 s	120 V	13 s	13 s
	100 V	18 s	18 s	100 V	13 s	13 s

These values were calculated at 23°C.

run time (5418)	30 s to 9:59 h, as well as infinity (∞), Adjustable to 10 min in 30 s increments, then increments of 1 min
run time (5418 R)	0.5 min to 99 min, as well as infinity (∞), Adjustable to 10 min in 0.5 min increments, then increments of 1 min
Temperature (only 5418 R)	0°C to 40°C
Relative centrifugal force (RCF)	1 to 16,873 x g adjustable to 5000 x g in 100 x g increments, then increments of 200 x g.
RPM	100 to 14,000 rpm adjustable in 100 rpm increments
Maximum load	18 micro test tubes of 2.0 mL each.
Max. kinetic energy	2,600 Nm
Test log mandatory:	No
Allowable density of the centrifuge material (at maximum g-force (rcf)/speed (rpm) and maximum load)	1.2 g/mL

Technical data

Centrifuge 5418 / 5418 R

English (EN)

10 Ordering information

10.1 Centrifuge 5418

Order no. (International)	Order no. (North America)	Description
5418 000.017 -	022620321 022620304	Centrifuge 5418 with rotor FA-45-18-11 incl. rotor lid 230 V / 50 – 60 Hz 120 V / 50 – 60 Hz, with US-plug

10.2 Centrifuge 5418 R

Order no. (International)	Order no. (North America)	Description
5401 000.013 -	5401000013 5401000137	Centrifuge 5418 R with rotor FA-45-18-11 incl. rotor lid 230 V / 50 Hz 120 V / 50 – 60 Hz, with US-plug

10.3 Accessories

Order no. (International)	Order no. (North America)	Description
5418 707.005	022652061	Rotor FA-45-18-11 aerosol-tight, angle 45°, 18 places, max. tube diameter 11 mm, incl. rotor lid (aluminum)
5418 708.001	022652087	Rotor lid for FA-45-18-11 aerosol-tight, aluminum
5418 709.008	022652109	Seal for rotor lid FA-45-18-11 and FA-45-6-30 5 pieces
5425 715.005 5425 717.008 5425 716.001	022636260 022636243 022636227	Adapter used in FA-45-18-11 for 1 PCR tube (0.2 mL, max. Ø 6 mm), set of 6 for 1 sample tube (0.4 mL, max. Ø 6 mm), set of 6 for 1 sample tube (0.5 mL, max. Ø 6 mm) or 1 Microtainer (0.6 mL, max. Ø 8 mm), set of 6
5416 301.001	022634305	Rotor key Standard
5401 850.076	5401850076	Tray for condensation water

*) Aerosol impermeability tested and certified by the Centre of Emergency Preparedness and Response, Health Protection Agency, Porton Down (UK).

Ordering informationCentrifuge 5418 / 5418 R
English (EN)

10.4 Fuses

10.4.1 Fuses for Centrifuge 5418

Order no. (International)	Order no. (North America)	Description
5425 351.003	022668188	Fuse 2.5 A T (230 V), set of 2
5425 353.006	022668226	5 A T (120 V), UL, set of 2

10.4.2 Fuses for Centrifuge 5418 R

Order no. (International)	Order no. (North America)	Description
5425 351.003	022668188	Fuse 2.5 A T (230 V), set of 2
5426 355.100	022668200	6.25 AT (100 V/120 V), set of 2

EG-Konformitätserklärung EC Conformity Declaration

Das bezeichnete Produkt entspricht den einschlägigen grundlegenden Anforderungen der aufgeführten EG-Richtlinien und Normen. Bei einer nicht mit uns abgestimmten Änderung des Produktes oder einer nicht bestimmungsgemäßen Anwendung verliert diese Erklärung ihre Gültigkeit.

The product named below fulfills the relevant fundamental requirements of the EC directives and standards listed. In the case of unauthorized modifications to the product or an unintended use this declaration becomes invalid.

Produktbezeichnung, Product name:

Centrifuge 5418 / 5418 R

einschließlich Zubehör / including accessories

Produkttyp, Product type:

Laborzentrifuge / Laboratory Centrifuge

Einschlägige EG-Richtlinien/Normen, Relevant EC directives/standards:

2006/95/EG, EN 61010-1, EN 61010-2-20

2011/65/EU

2004/108/EG, EN 55011/B, EN 61000-6-1, EN 61000-3-2, EN 61000-3-3, EN 61326-1

98/79/EG, EN 14971, EN 61010-2-101, EN 61326-2-6, EN 62366, EN 18113-3

H.-G. Köhl

Vorstand, Board of Management:

P. Ferrei

Projektmanagement, Project Management:

14.08.2012

Hamburg, Date:

eppendorf



Eppendorf AG · Barkhausenweg 1 · 22339 Hamburg · Germany

Certificate of Compliance

Certificate Number 20110415-E215059
Report Reference E215059, 2001 April 06
Issue Date 2011 April 15

Page 1 of 1



Issued to: **EPPENDORF A G**

BARKHAUSENWEG 1
22339 HAMBURG GERMANY

*This is to certify that
representative samples of*

LABORATORY USE ELECTRICAL EQUIPMENT
Model: 5418R

*Have been investigated by Underwriters Laboratories Inc.® (UL) or any authorized
licensee of UL in accordance with the Standard(s) indicated on this Certificate.*

Standard(s) for Safety:

UL 3101-1, First Edition
CAN/CSA-C22.2 No. 1010.1-92

Additional Information:

See UL On-Line Certification Directory at www.UL.com for additional information.

Only those products bearing the UL Listing Mark for the US and Canada should be considered as being covered by UL's Listing and Follow-Up Service meeting the appropriate requirements for US and Canada.

The UL Listing Mark for the US and Canada generally includes: the UL in a circle symbol with "C" and "US" identifiers:

 the word "LISTED"; a control number (may be alphanumeric) assigned by UL; and the product category name (product identifier) as indicated in the appropriate UL Directory.

Look for the UL Listing Mark on the product

William R. Carney

Director, North American Certification Programs

Underwriters Laboratories Inc.

Any information and documentation involving UL Mark services are provided on behalf of Underwriters Laboratories Inc. (UL) or any authorized licensee of UL. For questions, please contact a local UL Customer Service Representative at <http://www.ul.com/global/eng/pages/corporate/contactus/>



Certificate of Containment Testing

Containment Testing of Rotor
FA 45-18-11 (5418 707.102-02, 50 x
autoclaved at 121°C for 20 minutes)
Eppendorf Centrifuge 5418 / 5418R

Report No. 73-08 C

Report prepared for: Eppendorf AG, Hamburg, Germany
Issue Date: 10th March 2008 (amended 24th Sept 2009)

Test Summary

Rotor FA 45-18-11 (5418 707.102-02, 50 x autoclaved at 121°C for 20 minutes) was containment tested in the Eppendorf 5418 / 5418R centrifuge, using Annex AA of IEC 1010-2-20. The rotor was shown to contain a spill within the rotor.

Report Written By

Anna May

Report Authorised By

A handwritten signature in black ink, appearing to be "A. J. P.", written over a horizontal dashed line.

Evaluate your manual

Give us your feedback.
www.eppendorf.com/manualfeedback