



Thermomixer comfort / Thermomixer R

Operating Manual

eppendorf

Copyright© 2007 Eppendorf AG, Hamburg. No part of this publication may be reproduced without the prior permission of the copyright owner.

Trademarks

eppendorf® and eppendorf Thermomixer® are registered trademarks of Eppendorf AG, Hamburg, Germany.

Thermomixer is a trademark of Eppendorf AG, Hamburg, Germany.

Falcon™ is a registered trademark of Becton Dickinson, Franklin Lakes, USA.

Trademarks are not marked in all cases with ™ or ® in this manual.



Your Online Product Registration

Register your Eppendorf instruments online and get rewarded!

Learn more: www.eppendorf.com/myeppendorf

Not available in all countries.

Table of contents

1 User instructions **7**

1.1 Using this manual 7

1.2 Warning signs and hazard icons 7

1.3 Symbols used 7

1.4 Abbreviations used 8

1.5 Glossary 8

2 Product description **9**

2.1 Main illustration 9

2.2 Delivery package 9

2.3 Features 10

2.3.1 Thermomixer comfort / Thermomixer R 10

2.3.2 IsoTherm system (optional accessory) 11

3 Safety **12**

3.1 Intended use 12

3.2 User profile 12

3.3 Note on product liability 12

3.4 Warnings for intended use 12

3.5 Warning and instruction signs on the device 15

4 Installation **16**

4.1 Preparing installation 16

4.2 Selecting location 16

4.3 Installing instrument 16

5 Operation **17**

5.1 Overview of operating controls 17

5.2 Inserting exchangeable thermoblocks 18

5.2.1 Exchangeable thermoblocks for micro test tubes 19

5.2.2 MTP exchangeable thermoblock 19

5.2.3 Adapter plate for 0.2 ml tubes or 96 Well PCR plates 20

5.2.4 Exchangeable thermoblocks for slides and slides DC 20

5.3 Inserting tubes and plates 21

5.4 Time counting mode 21

5.5 Temperature control and mixing 22

5.5.1 Basic temperature control 22

5.5.2 Operation without temperature control 22

5.5.3 Mixing 22

5.5.4 Short Mix 23

5.5.5 Interrupting operation 23

5.5.6 Interval Mix 23

5.5.7 Programmable temperature control 24

5.5.8 Save the values 24

Table of contents





6	Troubleshooting	25
6.1	General errors	25
6.2	Error messages	25
7	Maintenance	26
7.1	Cleaning	26
7.2	Disinfection / Decontamination	27
7.3	Decontamination before shipping	27
7.4	Temperature control	27
8	Transport, storage and disposal	28
8.1	Transport	28
8.2	Storage	28
8.3	Disposal	28
9	Technical data	29
9.1	Power supply	29
9.2	Ambient conditions	29
9.3	Weight / dimensions	29
9.4	Application parameters	29
9.5	Additional data	30
9.5.1	Interfaces	30
9.5.2	Time interval	30
10	Ordering information	31
10.1	Thermomixer comfort / Thermomixer R	31
10.2	Exchangeable thermoblocks and adapter plates	31
10.3	Tubes and plates	32
10.4	IsoTherm-System	33
10.5	Temperature sensor	33
11	Index	34

1 User instructions

1.1 Using this manual

- ▶ Before using the device for the first time, please read the operating manual.
- ▶ Please view this operating manual as part of the product and keep it somewhere easily accessible.
- ▶ If the device is transferred to a third party, include this operating manual.

1.2 Warning signs and hazard icons

Depiction	Meaning
	DANGER Risk of electric shock with potential for severe injury or death as a consequence.
	DANGER Risk of explosion with potential for severe injury or death as a consequence.
	WARNING Warning of potential injury or health risk.
	CAUTION Refers to risk of damage to property.
	Refers to particularly useful information and tips.

1.3 Symbols used

Depiction	Meaning
▶	You are requested to perform an action.
1. 2.	Perform these actions in the sequence described.
•	List.
Text	Terms from the device display.

1 User instructions

1.4 Abbreviations used

DWP	Deepwell plate
MTP	Microplate
PCR	Polymerase Chain Reaction
rpm	Revolutions per minute

1.5 Glossary

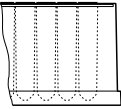
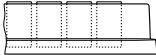
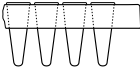
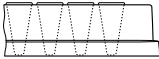
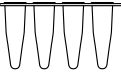
Deepwell plate	Plate with 48, 96 or 384 wells with a larger volume than microplates. Suitable for the preparation, mixing, centrifuging, transporting and storing of solid and liquid samples.	
Microplate	Plates with 24, 48, 96 or 384 wells for the preparation, mixing, centrifuging, transporting and storing of solid and liquid samples.	
semi-skirted PCR plate	PCR plate with surrounding half-edge.	
skirted PCR plate	PCR plate with a surrounding edge.	
unskirted PCR plate	PCR plate without a surrounding edge.	
Well	Cavity. Microplate, PCR plate or Deepwell plate tube.	

2 Product description

2.1 Main illustration

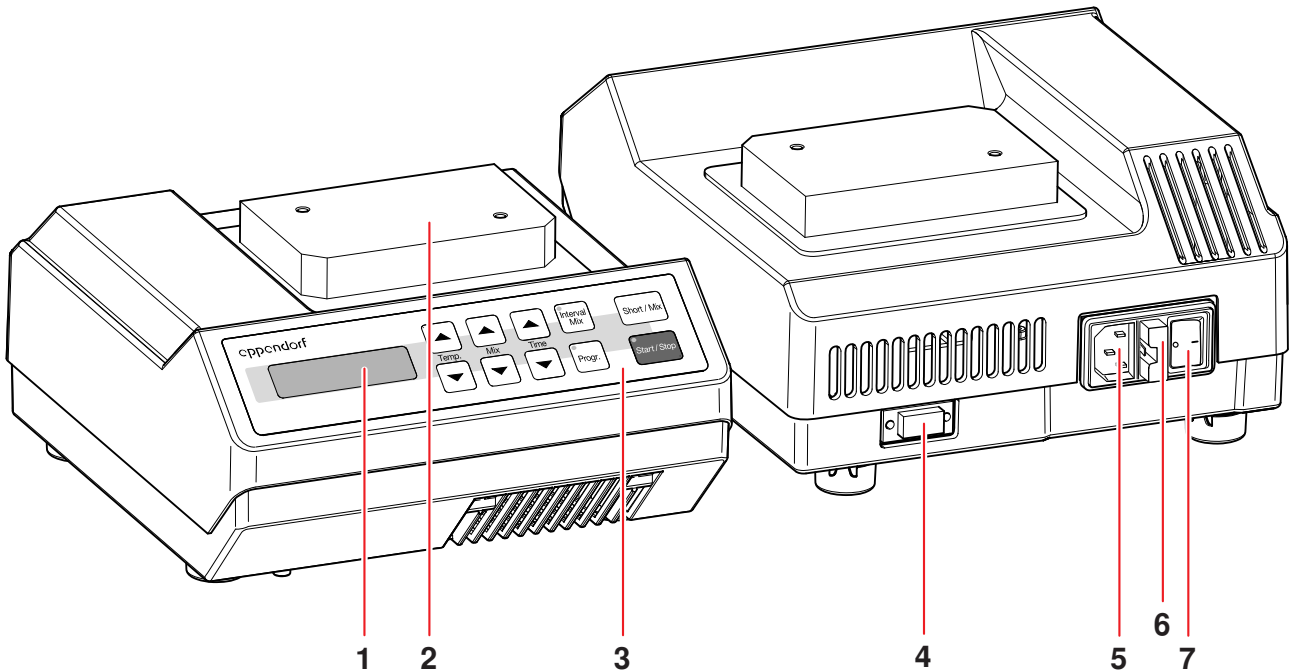

Fig. 1: Thermomixer compact

1 Display	2 Thermosocket
3 Operating controls	4 RS 232 interface
5 Mains connection socket	6 Fuse connector
7 Mains switch	

2.2 Delivery package

Quantity	Order No. (International)	Order No. (North America)	Description
	5355 000.011	-	Thermomixer comfort without exchangeable thermoblock
or	-	022670107	Thermomixer R without exchangeable thermoblock
1	-	-	Mains cable
1	-	-	Hexagon socket key
1	5355 900.012	-	Operating Manual Thermomixer comfort / Thermomixer R

2 Product description

2.3 Features

2.3.1 Thermomixer comfort / Thermomixer R

The Thermomixer comfort / Thermomixer R offers many options for temperature control and mixing of liquids in the microliter and milliliter ranges:

- In exchangeable thermoblocks liquids can be simultaneously mixed and temperature-controlled
 - in 0.2, 0.5, 1.5, 2.0 ml micro test tubes (e.g. Eppendorf Safe-Lock and PCR tubes),
 - in Falcon tubes 15 and 50 ml,
 - in 1.5 and 2 ml Cryo tubes,
 - in 5 ml test tubes made from plastic or glass
 - as well as MTP or DWP with any bottom contours, incl. PCR plates
- Cooling down the samples to 13 °C below room temperature is achieved by Peltier cooling.

Two special functions extend the area of application of the Thermomixer comfort / Thermomixer R

- Interval mixing:
Continuous alternation between mixing phase and standstill where mixing frequency and duration of the mixing and pause functions can be freely selected.
- Program mode:
In addition to a normal mixing/temperature control run two combined, consecutive mixing/temperature control runs can be freely programmed. When the first run is completed, the second run will switch on automatically so that two different treatments of the same liquid can be carried out.

With the Eppendorf IsoRack, a total of 24 micro test tubes can be placed on an exchangeable thermoblock. The IsoRack is part of the IsoTherm system. This means that with the Thermomixer comfort / Thermomixer R and the IsoTherm system, micro test tubes can be handled on the lab bench at all the temperatures that are relevant for everyday lab use.

The robust, space-saving design of the Thermomixer comfort / Thermomixer R combined with the chemical-resistant plastic housing and the keypad make this Eppendorf device another professional companion in your daily routine.

2 Product description

2.3.2 IsoTherm system (optional accessory)

With the IsoTherm system the samples can be cooled efficiently and at a constant temperature for several hours and then be thawed gently.

In addition, the tube holder serves as a working aid during the filling of micro test tubes and the preparation, sorting, distribution, transporting, storing and freezing of samples in micro test tubes.

The IsoTherm system includes the components IsoRack, IsoPack, IsoSafe and PCR-Cooler.

Features

- IsoPack and IsoSafe

Cooling batteries for -21 °C and 0 °C which allow temperature-sensitive samples to be stored for hours on the lab bench in micro test tubes and in a corresponding insulated box (IsoSafe).

- IsoRack

Tube holder for 24 micro test tubes (0.5 ml or 1.5/2.0 ml) each to transfer the tubes from the cooling battery to the exchangeable thermoblocks. The lockable and stackable, snap-together IsoRacks are also particularly suited to the storage of micro test tubes in refrigerators or freezers. The IsoRacks can be autoclaved. The spacing of the test tubes in the IsoRack is determined by the use of multi-channel pipettes.

- PCR-Cooler

Cool pack for 0 °C for the storage of PCR tubes or plates (semi-skirted, unskirted and skirted) on the lab bench and in an insulated box (IsoSafe).



Further details can be found on our homepage www.eppendorf.com and in the operating manual for the IsoTherm system.

3 Safety

3.1 Intended use

The Thermomixer comfort / Thermomixer R is intended exclusively for indoor use and is for the temperature control and mixing of aqueous solutions in closed micro test tubes and plates. Only use Eppendorf accessories or accessories recommended by Eppendorf.

3.2 User profile

This device must only be used by skilled personnel with the appropriate training. Before using the device, read the operating manual carefully and familiarize yourself with the device's mode of operation.

3.3 Note on product liability

In the following cases the protection provided in the device may be impaired. The liability for the function of the device passes to the operator if:

- The device is not used in accordance with the operating manual.
- The device is used outside the range of application described herein.
- The device is used with accessories or consumables (e.g. tubes and plates) which are not recommended by Eppendorf.
- The device is maintained or repaired by persons not authorized by Eppendorf.
- The owner has made unauthorized modifications to the device.

3.4 Warnings for intended use

Please read the operating manual and note the following general safety instructions before using the Thermomixer comfort / Thermomixer R.



Risk of explosion!

- ▶ Do not operate the device in rooms where work is being carried out with explosive substances.
- ▶ Do not use this device to process any explosive or highly reactive substances.
- ▶ Do not use this device to process any substances which could create an explosive atmosphere.



Danger! Electric shock from damage to device/power cable.

- ▶ Only switch on the device if the device and the power cable are undamaged.
- ▶ Only use devices that have been properly installed or repaired.



Danger! Lethal voltages inside the device.

- ▶ Ensure that the housing is always closed and undamaged so that no parts inside the device can be contacted by accident.
- ▶ Do not remove the housing of the device.
- ▶ Do not allow the device to be opened by anyone except service personnel who have been specifically authorized by Eppendorf.

3 Safety



Danger! Electric shock as a result of penetration of liquid.

- ▶ Switch off the device and disconnect it from the power supply before starting cleaning or disinfecting.
- ▶ Do not allow any liquids to enter the inside of the housing.
- ▶ Do not perform spray disinfection.
- ▶ Only reconnect the device to the power supply once it is completely dry.



Danger! Damage to health from biologically or chemically hazardous substances.

Hazardous chemicals cause burns and other health hazards.

- ▶ Observe the material safety data sheets for the biological and chemical substances used.
- ▶ Wear personal protective equipment (PPE) at all times when working with biological or chemical substances.
- ▶ Follow the instructions for cleaning and decontamination, and ensure that hygiene safety standards are maintained.



Risk when handling toxic or radioactively-marked liquids or pathogenic germs.

- ▶ Follow national regulations governing the handling of these substances.
- ▶ For complete instructions regarding the handling of germs or biological material of risk group II or higher, please refer to the "Laboratory Biosafety Manual" (Source: World Health Organization, current edition of the Laboratory Biosafety Manual).



Warning! Damage due to incorrect power supply.

- ▶ Only connect the device to power sources that match the electrical specifications on the device's nameplate.
- ▶ Use only sockets with protective earth.



Warning! Risk of burns from hot surfaces.

The exchangeable thermoblock and the thermal base can be very hot after heating and cause burns.

- ▶ Allow heated exchangeable thermoblocks and the thermal base to cool down completely before removing the exchangeable thermoblock.



Warning! Risk of injury through chemical or mechanical damage to exchangeable thermoblocks.

- ▶ Check the exchangeable thermoblocks regularly.
- ▶ Do not use exchangeable thermoblocks that show signs of corrosion or mechanical damage.



Warning! Poor safety due to incorrect accessories and spare parts.

The use of accessories and spare parts other than those recommended by Eppendorf may impair the safety, function and precision of the device. Eppendorf accepts no warranty or liability for damage caused by non-recommended accessories and spare parts or incorrect use.

- ▶ Use only accessories recommended by Eppendorf and original spare parts.

3 Safety

**Warning! Risk to health from contaminated device**

- ▶ Perform decontamination before storing or dispatching the device and/or its accessories.

**Warning! Contamination due to opening tube lids.**

In the following cases, the lids of PCR tubes can spring open and the sample material can escape:

- high vapor pressure of the content
 - improperly sealed lid
 - damaged sealing lip
- ▶ Always check that micro test tubes have been sealed tightly before use.

Caution! Strong vibration.

At high speeds items near the device can be moved by vibrations of the work surface and may e.g. fall off the work table.

- ▶ Do not place easily movable items near the mixer or secure them adequately.

Caution! Damage to the display due to mechanical pressure.

- ▶ Do not exert mechanical pressure on the display.

Caution! Damage to electronic components from condensation.

- ▶ After moving the device from a cooler environment (e.g: cool room or outdoors), wait at least an hour before connecting it to the mains power supply.

Caution when using aggressive chemicals.

Aggressive chemicals may damage both the device and its accessories.

- ▶ Do not use any aggressive chemicals on the device and accessories such as strong or weak bases, strong acids, acetone, formaldehyde, halogenated hydrocarbons or phenol.
- ▶ If the device becomes contaminated with aggressive chemicals, clean it immediately with a neutral cleaning agent.

Caution! Lack of safety due to missing operating manual.

- ▶ When passing on the device, always enclose the operating manual.
- ▶ If you lose the operating manual, request a replacement. The current version of the operating manual and the safety instructions can also be found on our website www.eppendorf.com.

3 Safety

3.5 Warning and instruction signs on the device

Depiction	Meaning	Location
 <p>The sign consists of two triangular warning symbols (a triangle with an exclamation mark) flanking the text "Caution: Hot surface".</p>	<p>Warning! Risk of burns from hot surfaces.</p> <p>The exchangeable thermoblock and the thermal base can be very hot after heating and cause burns.</p> <ul style="list-style-type: none"> ▶ Allow heated exchangeable thermoblocks and the thermal base to cool down completely before removing the exchangeable thermoblock. 	Upside of device

4 Installation

4.1 Preparing installation

i Retain the transport carton and the packing material for subsequent safe transport or storage.

- ▶ Check the completeness of delivery based on the details of the scope of delivery .(see *Delivery package* on page 9)
- ▶ Check all parts for any transport damage.

4.2 Selecting location

Select a location for the Thermomixer comfort / Thermomixer R in accordance with the following criteria:

- Mains power connection (230 V/120 V) as per device identification plate. This is located on the rear side of the device.
- At least 10 cm away from adjacent devices and walls.
- Solid bench with stable, horizontal and even work surface.

4.3 Installing instrument



Warning! Damage due to incorrect power supply.

- ▶ Only connect the device to power sources that match the electrical specifications on the device's nameplate.
- ▶ Use only sockets with protective earth.

1. Place the Thermomixer comfort / Thermomixer R on a suitable work surface so that the ventilation slots on the base of the device are not blocked.
2. Connect the power cable supplied to the mains connection socket (5) of the Thermomixer comfort / Thermomixer R and the power supply (see Fig. 1 on page 9).
3. Switch on the Thermomixer comfort / Thermomixer R using the mains switch (7) (see Fig. 1 on page 9).
4. Fit the exchangeable thermoblock (see *Inserting exchangeable thermoblocks* on page 18).

5 Operation

5.1 Overview of operating controls

Before using the Thermomixer comfort / Thermomixer R for the first time, familiarize yourself with the operating controls and the display.

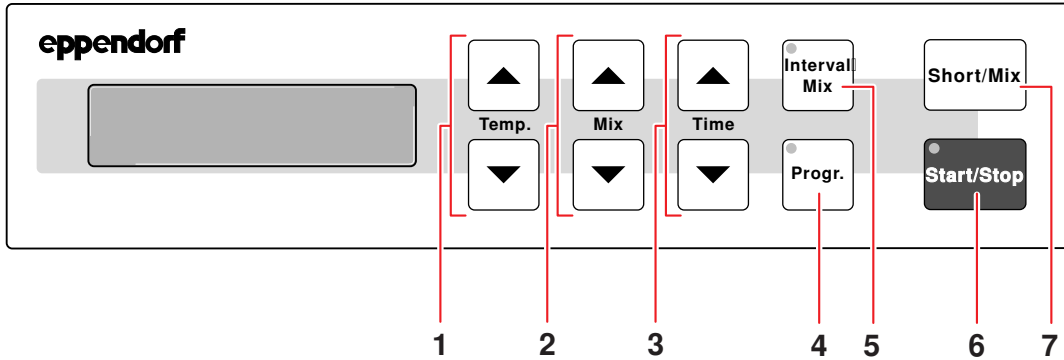

Fig. 2: Operating controls

1 Setting the temperature	2 Setting the mixing frequency
3 Setting the run time	4 Programming mixing/temperature control runs
5 Starting interval mix	6 Starting or stopping a run
7 Starting Short Mix	

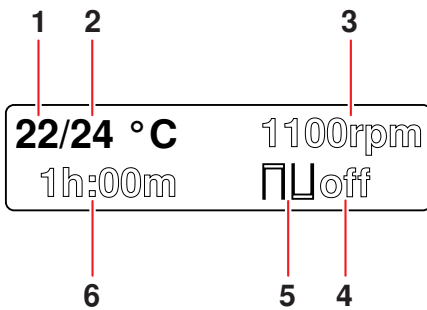

Fig. 3: Display

1 Nominal temperature	2 Actual temperature
3 Mixing frequency	4 Display interval mixing time
5 Display interval mixing function	6 Total time

i After switching on, the display shows the values of the last run.

5 Operation

5.2 Inserting exchangeable thermoblocks



Warning! Risk of injury through chemical or mechanical damage to exchangeable thermoblocks.

- ▶ Check the exchangeable thermoblocks regularly.
- ▶ Do not use exchangeable thermoblocks that show signs of corrosion or mechanical damage.



Warning! Injury or property damage from improperly attached exchangeable thermoblocks.

If the exchangeable thermoblocks are not attached properly, they can become detached from the device or break.

- ▶ Tighten the screws of the exchangeable thermoblocks fingertight.



Warning! Contamination due to opening tube lids.

In the following cases, the lids of PCR tubes can spring open and the sample material can escape:

- high vapor pressure of the content
 - improperly sealed lid
 - damaged sealing lip
- ▶ Always check that micro test tubes have been sealed tightly before use.

The following exchangeable thermoblocks can be set on the Thermomixer comfort / Thermomixer R:

Exchangeable thermoblock 0.5 ml:	24 x 0.5 ml micro test tubes
Exchangeable thermoblock 1.5 ml:	24 x 1.5 ml micro test tubes
Exchangeable thermoblock 2.0 ml:	24 x 2.0 ml micro test tubes
Exchangeable thermoblock Cryo:	24 x 1.5 or 2.0 ml Cryo tubes
Exchangeable thermoblock lab tubes:	24 tubes at 11 – 11.9 mm, height 30 to 76 mm
Exchangeable thermoblock 15 ml Falcon:	8 x 15 ml Falcon tubes
Exchangeable thermoblock 50 ml Falcon:	4 x 50 ml Falcon tubes
Exchangeable thermoblock MTP:	MTP and DWP, PCR tubes and plates
Exchangeable thermoblock slides:	4 slides
Exchangeable thermoblock slides DC:	4 slides DC



To insert the exchangeable thermoblocks, use the accessories supplied (e.g. screw driver, screws, flat washers and lock washers).

5 Operation

EN

Operating Manual

5.2.1 Exchangeable thermoblocks for micro test tubes

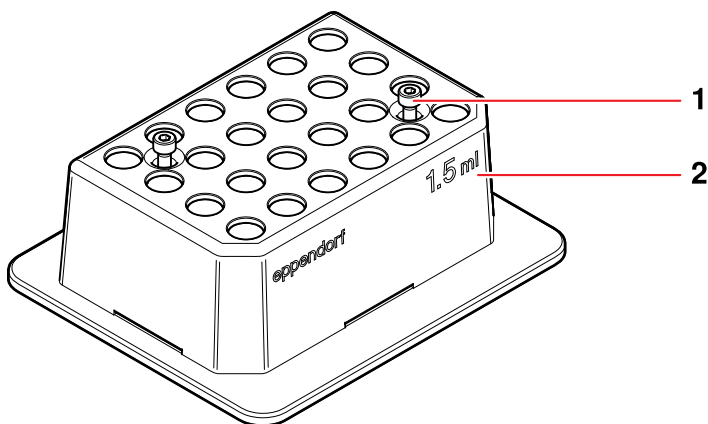

1. Place the exchangeable thermoblock (2) on the thermosocket with both flat edges and the writing facing the front.
2. Tighten the captive screws (1).

5.2.2 MTP exchangeable thermoblock

Caution! Microplates melt at extremely high temperatures.

- ▶ Only heat microplates made of polystyrene to a maximum 70 °C.
-

1. Insert the short screws in the MTP exchangeable thermoblock with the flat washers.
2. Secure the screws from below using the lock washers.
The lock washers prevent the screws from falling out of the bores if the exchangeable thermoblock is not fixed on the unit.
3. Place the MTP thermoblock on the device in such a way that the spring plate is to the front left.
4. Tighten the screws.

5 Operation

EN

Operating Manual

5.2.3 Adapter plate for 0.2 ml tubes or 96 Well PCR plates

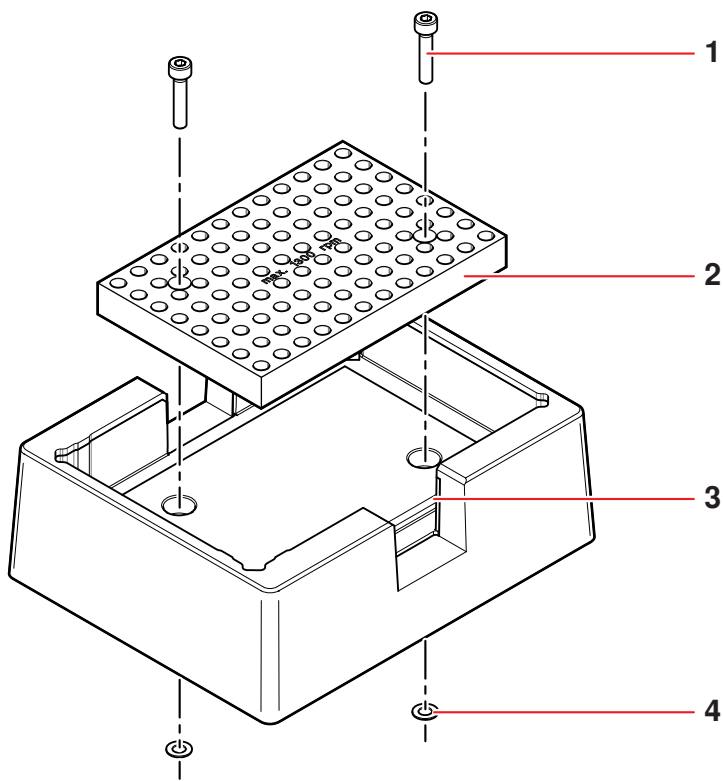

1. Remove the lock washers (4) from the short screws in the exchangeable thermoblock.
2. Remove the short screws.
3. Connect the adapter plate (2) to the MTP thermoblock (3) using the long screws (1).
4. Secure the screws from below using the lock washers.
The lock washers prevent the screws from falling out of the bores if the exchangeable thermoblock is not fixed on the unit.
5. Place the adapter plate on the device with the MTP thermoblock.
6. Tighten the screws.

5.2.4 Exchangeable thermoblocks for slides and slides DC

1. Open the lid.
2. Place the exchangeable thermoblock on the heating/cooling plate with the writing facing the front.
3. Tighten the screws of the exchangeable thermoblock.

5 Operation

5.3 Inserting tubes and plates

Caution! Microplates melt at extremely high temperatures.

- ▶ Only heat microplates made of polystyrene to a maximum 70 °C.

1. Select a suitable exchangeable thermoblock and mount it (see *Inserting exchangeable thermoblocks* on page 18).
2. Place the tubes or plate on the thermoblock.
For optimum temperature control transfer the micro test tubes to the exchangeable thermoblocks using IsoRacks. The IsoRack reduces the heat exchange of the thermoblock with the environment. If necessary close the IsoRack lid.
3. If using the MTP thermoblock: put the lid on.

5.4 Time counting mode

The time counting function enables temperature control and/or mixing for a limited period of time. The temperature will be held constant by the device even after the set time has elapsed.

There are two ways to measure the time of the temperature control processes:

- **Time control:**

Time counting begins immediately when "Start/Stop" is pressed. The indicator lamp in the key lights up.

- **Temp control:**

Time counting only starts when the nominal temperature value has been reached.

During the time in which the device controls the temperature to reach the nominal temperature, the colon of the time display flashes. This signals that the device is active. When the nominal temperature has been reached and time counting starts, the indicator lamp of the "Start/Stop" key lights up.

To terminate the process early, press the "Start/Stop" again.

1. Hold the "Progr." key while switching the device on. Hold the key until the display either shows **time control** or **temp control**.
2. Using the "Time" arrow keys, set time counting.

22/24 °C	1100rpm
1h:00m	□□off

On the display, the time will appear on the bottom left. The time can be set from 1 minute to 99 hours 59 minutes. Pressing the key once will alter the setting by one minute. During the run the remaining run time will be displayed in minutes. The last minute is counted down in seconds.

5 Operation

5.5 Temperature control and mixing

After switching on the values used before switching off will be shown on the display. The actual temperature flashes. The device is now in basic temperature control mode.

i The Thermomixer comfort / Thermomixer R can cool to 13 °C below room temperature.

5.5.1 Basic temperature control

- ▶ Set the temperature with the "Temp." arrow keys or press "Start/Stop", if you do not want to change the nominal temperature.

22/24 °C	1100rpm
1h:00m	off

The device starts the temperature control. On the display, the nominal temperature is displayed on the left, the actual temperature on the right. The temperature between 1 °C and 99 °C is then adjusted immediately. When the nominal value is reached, only this value will be displayed.

The temperature can be adjusted gradually by pressing the key briefly or continuously by pressing the key continuously.

You can also change the nominal temperature while the device is running. The run will be continued with the re-set nominal temperature.

5.5.2 Operation without temperature control

- ▶ Press the "Temp." arrow key until **off** appears on the display.
The device remains at room temperature and does not heat. You can now use the device as a mixer without temperature control.

5.5.3 Mixing

The mixing frequency (-- rpm) is displayed on the right of the display next to the temperature.

22/24 °C	1100rpm
1h:00m	off

1. Set the mixing frequency with the "Mix" arrow keys.
You can set the mixing frequency to 0 or between 300 and 1,500 rpm. Pressing the key once will adjust the frequency by 50 rpm.
Depending on the software version the device will recognize the mounted exchangeable thermoblock automatically. The mixing frequency specified for the exchangeable thermoblock cannot be increased in this case.
2. Press the "Start/Stop" key to start the mixing process.
During the run the green indicator lamp in the "Start/Stop" key lights up.
3. To finish the mixing process, press "Start/Stop" again.

5 Operation

After setting the required parameters, the device will start mixing and/or the temperature control after pressing the "Start/Stop" key. The temperature control may have also started by re-setting the nominal value for the temperature control.

When the pre-set time has elapsed or the "Start/Stop" key is pressed again, mixing is completed. The temperature is, however, kept constant.

5.5.4 Short Mix

- ▶ Keep the "Short Mix" key pressed.

The device mixes with the set frequency until the "Short Mix" key is released. During the first minute, time counting starts in second intervals and then changes to minute intervals.

5.5.5 Interrupting operation

1. Keep the "Start/Stop" key pressed for more than two seconds.
Mixing and time counting are interrupted. You can now carry out manual operations (e.g. adding reagents, replacing tubes).
2. To continue the run, press the "Start/Stop" key again.

5.5.6 Interval Mix

The "Interval Mix" function enables a continuous alternation of mixing activity and mixing pause. The device carries out the mixing procedure, interrupted by pauses, until the set total time has elapsed. The times for mixing and the mixing pause (from 3 seconds to 99 minutes 59 seconds) can be set independently.

1. Press the "Interval Mix" key for two seconds or more.

22/20 °C	1100rpm
1h:00m	▮ 0m:5s

The green indicator lamp of the key lights up in green. On the display appears the sign ▮.
The interval function is now activated.

2. Using the "Time" arrow keys, set the total time for the interval function.
3. Briefly press the "Interval Mix" key.
The sign ▮ flashes on the display.

22/20 °C	1100rpm
1h:30m	▮ 0m:10s

4. Using the "Time" arrow keys, set the mixing phase.
5. Briefly press the "Interval Mix" key.
The sign ▮ flashes on the display.

22/20 °C	1100rpm
1h:30m	▮ 0m:15s

5 Operation

6. Using the "Time" arrow keys, set the pause phase.
7. Press the "Start/Stop" key to start the interval function.
The device begins to alternate between mixing and mixing pause until the total time has elapsed.
8. To terminate the function before the time is up, hold the "Interval Mix" key for more than 2 seconds.
The indicator lamp goes out and the display shows **Off** .



5.5.7 Programmable temperature control

The function "Programmable temperature control" enables a program run which consists of up to two steps. The second step will be started automatically after the first step has been completed.

1. Hold the "Progr." key for more than two seconds.
The green indicator lamp in the key lights up. On the display appears the sign , to the left of the temperature display.

 37 °C	1400rpm
2h:15m	 off

2. Using the arrow keys, set the parameters. The interval mixing function can be used in addition.
3. Briefly press the "Progr." key.
On the display appears the sign , to the left of the temperature display. You are now in the second stage of the program.

 15/31 °C	0rpm
	 off

4. Using the arrow keys, set the parameters. The interval mixing function can be used in addition.
5. Press the "Start/Stop" key to start the program.
The program step which is currently visible on the display is now started. If it is the first step, the second step is started automatically after the first step has been completed.
To end the program before the run is completed,
 1. press the "Start/Stop" key again.
 2. To return to the mode of basic temperature control, press the "Progr." key.
In the "Temp control" mode (see *Time counting mode* on page 21) the  signs for the individual programming steps appear.

5.5.8 Save the values

The set values will be saved even after the device has been switched off.

6 Troubleshooting

6.1 General errors

- i** If the proposed measures to remedy the fault repeatedly do not deliver the desired result, contact your local Eppendorf partner. The addresses of our dealers are available on our website www.eppendorf.com, the addresses of our sales offices are on the penultimate page of this operating manual.

Symptom / message	Cause	Remedy
Display remains dark.	<ul style="list-style-type: none"> No mains connection. Device fuse defective. 	<ul style="list-style-type: none"> ▶ Check the mains connection and the power supply. ▶ Switch the device on.
Nominal temperature is not reached.	At nominal values over 4 °C above room temperature.	<ul style="list-style-type: none"> ▶ Set up the device in a cooler environment.
The device does not mix or control the temperature.	Various causes are possible.	<ul style="list-style-type: none"> ▶ Contact your local Eppendorf partner.

6.2 Error messages

Symptom / message	Cause	Remedy
MOTOR ERR	Motor is not turning.	<ol style="list-style-type: none"> 1. Switch device off and wait for 10 seconds. 2. Switch the device on.
SPEED ERR	Motor is turning at overspeed.	<ol style="list-style-type: none"> 1. Switch device off and wait for 10 seconds. 2. Switch the device on.
TOO HOT!	Thermoblock hotter than 110 °C.	<ol style="list-style-type: none"> 1. Switch device off and wait for 10 seconds. 2. Switch the device on.
T-SENSOR ERR	Temperature sensor error.	<ol style="list-style-type: none"> 1. Switch device off and wait for 10 seconds. 2. Switch the device on.
TEMP ERR!	Nominal temperature is not reached.	<ol style="list-style-type: none"> 1. Switch the device off and wait for 10 seconds. 2. Switch the device on.
EEchksumERR RAM ERR EEprom ERR	Memory error	<ol style="list-style-type: none"> 1. Switch the device off and wait for 10 seconds. 2. Switch the device on.
HEAVY LOAD	The motor does not reach nominal speed.	<ul style="list-style-type: none"> ▶ Check if the movement of the exchangeable thermoblock is obstructed (e.g. by jammed object).

7 Maintenance

7.1 Cleaning

Regularly clean the housing of the Thermomixer comfort / Thermomixer R and the exchangeable thermoblocks.



Danger! Electric shock as a result of penetration of liquid.

- ▶ Switch off the device and disconnect it from the power supply before starting cleaning or disinfecting.
- ▶ Do not allow any liquids to enter the inside of the housing.
- ▶ Do not perform spray disinfection.
- ▶ Only reconnect the device to the power supply once it is completely dry.

Caution when using aggressive chemicals.

Aggressive chemicals may damage both the device and its accessories.

- ▶ Do not use any aggressive chemicals on the device and accessories such as strong or weak bases, strong acids, acetone, formaldehyde, halogenated hydrocarbons or phenol.
- ▶ If the device becomes contaminated with aggressive chemicals, clean it immediately with a neutral cleaning agent.

Caution! Corrosion from aggressive cleaning agents and disinfectants.

- ▶ Do not use corrosive cleaning agents, aggressive solvents or abrasive polishes.

Auxiliary aids

- Lint free cloth
- Mild, soap-based household cleaning agent
- Dist. water

Cleaning the Thermomixer comfort / Thermomixer R

1. Switch the Thermomixer comfort / Thermomixer R off and isolate from the power supply.
2. Clean all of the outer parts of the Thermomixer comfort / Thermomixer R with a mild, soap-based solution and a lint-free cloth.
3. Wipe off the soap solution with dist. water.
4. Dry all cleaned parts.

7 Maintenance

7.2 Disinfection / Decontamination



Danger! Electric shock as a result of penetration of liquid.

- ▶ Switch off the device and disconnect it from the power supply before starting cleaning or disinfecting.
- ▶ Do not allow any liquids to enter the inside of the housing.
- ▶ Do not perform spray disinfection.
- ▶ Only reconnect the device to the power supply once it is completely dry.

Auxiliary equipment

- lint-free cloth,
 - disinfectant.
1. Switch the Thermomixer comfort / Thermomixer R off and isolate from the power supply.
 2. Allow the device to cool down.
 3. Clean the device (see *Cleaning* on page 26).
 4. Select a disinfection method which complies with the legal requirements and regulations applicable to your range of application.
 5. Wipe the surfaces with the lint-free cloth and disinfectant.

7.3 Decontamination before shipping

If you are shipping the device to the authorized Technical Service for repairs or to your authorized dealer for disposal please note the following:



Warning! Risk to health from contaminated device

1. Follow the instructions in the decontamination certificate. It is available in PDF format on our homepage (www.eppendorf.com/decontamination).
2. Decontaminate all the parts you want to dispatch.
3. Enclose the fully-completed decontamination certificate for returned goods (incl. the serial number of the device) with the dispatch.

7.4 Temperature control

The application parameters in the technical data (see p. 29) define the limits and deviations (tolerances) on all positions of a thermoblock / exchangeable thermoblock.

Use the temperature validation system for an exact control of the temperatures. For the 1.5 mL reference exchangeable thermoblock, there is a 1.5 mL temperature sensor for all Eppendorf Thermomixers and the ThermoStat plus that can measure the exact temperature in the block (see *Temperature sensor* on page 33).

8 Transport, storage and disposal

8.1 Transport

- ▶ Only transport the device in the original packaging.

	Air temperature	Rel. humidity	Air pressure
General transportation	-20 to 60 °C	10 to 95%	30 to 106 kPa
Air freight	-20 to 55 °C	10 to 95%	30 to 106 kPa

8.2 Storage

	Air temperature	Rel. humidity	Air pressure
In transport packaging	-25 to 55 °C	10 to 95%	70 to 106 kPa
Without transport packaging	-5 to 45 °C	10 to 95%	70 to 106 kPa

8.3 Disposal

In the event of disposing of the product, please observe the applicable legal regulations.

Information on the disposal of electrical and electronic devices in the European Community:

The disposal of electrical devices is regulated within the European Community by national regulations based on EU Directive 2002/96/EC pertaining to waste electrical and electronic equipment (WEEE).

In accordance with this, any devices delivered after 13/08/2005 on a business-to-business basis, which includes this product, may no longer be disposed of in household waste. To document this they have been marked with the following identification:



Because disposal regulations may differ from one country to another within the EU please contact your supplier if necessary.

9 Technical data

9.1 Power supply

Mains connection:	100 to 240 V \pm 10 %, 50 to 60 Hz
Fuses:	see nameplate or label on the rear of device
Power consumption:	90W

9.2 Ambient conditions

Environment:	For indoor use only
Ambient temperature:	4 to 35 °C
Relative humidity:	70 % max.

9.3 Weight / dimensions

Dimensions (W x D x H):	220 x 250 x 125 mm
Weight basic device:	3.2 kg

9.4 Application parameters

Temperature control range:	
Exchangeable thermoblocks for micro test tubes	13 °C below room temperature to 99 °C
Exchangeable thermoblocks for micro test plates	10 °C below room temperature to 99 °C
Temperature accuracy:	
Exchangeable thermoblock for 1.5 ml micro test tubes	
at nominal values between 20 °C and 45 °C	\pm 0.5 °C
at nominal values between <20 °C and >45 °C	\pm 2.0 °C
Exchangeable thermoblocks for micro test plates	
at nominal values <70 °C	\pm 2.0 °C
at nominal values between 70 °C and 99 °C	-5.0 °C

9 Technical data

EN

Operating Manual

Heating rate:	approx. 5 °C/min The temperature changes in the filled tubes are slower.
Cooling rate:	2 to 3 °C/min
Cooling rate from room temperature to 13 °C below room temp:	0.5 to 1.0 °C/min
Mixing frequencies for:	
Exchangeable thermoblocks 0.5 ml	300 to 1,500 1/min
Exchangeable thermoblocks 1.5 and 2.0 ml	300 to 1,400 1/min
Microplates	300 to 1,400 1/min
Falcon tubes	300 to 750 1/min
Cryo tubes	300 to 1,400 1/min

9.5 Additional data

9.5.1 Interfaces

EDP connection:	RS-232, Sub-D9 male
-----------------	---------------------

i Only connect devices to interfaces that meet the IEC 950/EN 60950 (UL 1950) standards.

9.5.2 Time interval

Programmable time interval:	1 min to 99:59 hours, infinitely adjustable
-----------------------------	---

10 Ordering information



Warning! Poor safety due to incorrect accessories and spare parts.

The use of accessories and spare parts other than those recommended by Eppendorf may impair the safety, function and precision of the device. Eppendorf accepts no warranty or liability for damage caused by non-recommended accessories and spare parts or incorrect use.

- ▶ Use only accessories recommended by Eppendorf and original spare parts.

10.1 Thermomixer comfort / Thermomixer R

Order No. (International)	Order No. (North America)	Description
5355 000.011	-	Thermomixer comfort without exchangeable thermoblock
-	022670107	Thermomixer R without exchangeable thermoblock

10.2 Exchangeable thermoblocks and adapter plates

Order No. (International)	Order No. (North America)	Description
5361 000.015 5360 000.011 5362 000.019	022670506 022670522 022670549	Exchangeable thermoblock for microcentrifuge tubes complete with IsoTherm Rack and IsoTherm cool pack 0°C 24 x 0.5 mL 24 x 1.5 mL 24 x 2.0 mL
5363 000.012	022670565	Exchangeable thermoblock for MTPs and deepwell plates with lid
5363 007.009	022670573	Adapter plate for 96 x 0.2 mL PCR tubes to insert in blocks for MTPs
5364 000.016	022670581	Exchangeable thermoblock for 24 micro test tubes 11 - 11.9 mm diam., height 30 - 76 mm
5366 000.013 5365 000.010	022670531 022670514	Exchangeable thermoblock for Falcon tubes for 8 x 15 mL for 4 x 50 mL
5367 000.017	022670557	Exchangeable thermoblock for 1.5 - 2 mL Cryo tubes
5368 000.010	022670590	Exchangeable thermoblock for 4 slides for hybridization experiments
5368 000.100	022670786	Exchangeable thermoblock for slides DC holds 4 DualChip slides, with clamping plate

10 Ordering information

10.3 Tubes and plates

Order No. (International)	Order No. (North America)	Description
0030 121.023	022363611	Safe-Lock micro test tubes 0.5 mL per 500 pcs. colorless
0030 120.086	-	Safe-Lock micro test tubes 1.5 mL per 1,000 pcs. colorless
0030 120.094	-	Safe-Lock micro test tubes 2.0 mL per 1,000 pcs. colorless
0030 124.502	951010057	PCR tubes thin-walled with hinged lid, colorless, 500 pcs. 0.5 mL
0030 124.332	951010006	0.2 mL PCR tubes 1,000 pcs., colorless
0030 124.340	951010014	Five-tube strip for 0.2 mL PCR Tubes colorless, pack of 125 (= 625 tubes)
0030 124.359	951010022	Eight-tube strip, for 0.2 mL PCR Tubes colorless, pack of 120 (= 960 tubes)
0030 124.200	951010006	PCR Tubes 0.2 mL per 1,000 pcs. colorless
0030 128.648	951020401	twin.tec PCR Plate 96, skirted Wells colorless, 25 pcs. clear
0030 128.575	951020303	twin.tec PCR Plate 96, semi-skirted Wells colorless, 25 pcs. clear
0030 521.102	951031003	Eppendorf Deepwell Plate 384/200 µL 40 plates, border color white Standard
0030 501.101	951031801	Eppendorf Deepwell Plate 96/500 µL 40 plates, border color white Standard
0030 501.209	951032603	Eppendorf Deepwell Plate 96/1000 µL 20 plates, border color white Standard
0030 501.306	951033405	Eppendorf Deepwell Plate 96/2000 µL 20 plates, border color white Standard

All plates are also available with different border colors (red, yellow, green and blue) and purity qualities, in large packs as well as with barcoding on request. You can find further information in our catalog or our website www.eppendorf.com.

10 Ordering information

10.4 IsoTherm-System

Order No. (International)	Order No. (North America)	Description
3880 001.018 3880 000.011	022510053 022510002	IsoTherm System includes IsoSafe, IsoRack, 0 °C IsoPack and -21 °C for 1.5 mL / 2.0 mL tubes 0.5 mL tubes
3881 000.015 3881 000.023 3881 000.031	022510509 022510541 022510525	PCR-Cooler Starter Set (1 x pink, 1 x blue) Pink Blue

10.5 Temperature sensor

Order No. (International)	Order No. (North America)	Description
0055 000.298	950008059	Temperature validation system for Mastercycler, Mastercycler ep and Mastercycler pro
5354 850.500	on request	Temperature sensor - 1.5 mL

Index

EN

Operating Manual

A

Ambient conditions 29

Application parameter 29

C

Cleaning 26, 26

D

Decontamination 27

Deepwell plate 8

Dimensions 29

Disposal 28

E

Error messages 25

F

Fault remedy 25

G

Glossary 8

H

Hazard icons 7

Hazards 12

I

Installation

 Device 16

 Preparation 16

 Select location 16

Intended use

 Hazards 12

IsoPack 11

IsoSafe 11

IsoTherm system 11

M

Microplate 8

O

Operating controls 17

P

PCR plate

 semi-skirted 8

 skirted 8

 unskirted 8

PCR-Cooler 11

Power supply 29

S

Safety instructions 12

Safety notes

 Meaning of the symbols 7

Select location 16

Storage 28

T

Technical data

 Ambient conditions 29

 Application parameter 29

 Dimensions 29

 Power supply 29

Temperature control 27

Transport 28

W

Warning signs

 Device 15

 Instructions 7

Weight

 Device 29

Well 8

EG-Konformitätserklärung EC Conformity Declaration

Das bezeichnete Produkt entspricht den einschlägigen grundlegenden Anforderungen der aufgeführten EG-Richtlinien und Normen. Bei einer nicht mit uns abgestimmten Änderung des Produktes oder einer nicht bestimmungsgemäßen Anwendung verliert diese Erklärung ihre Gültigkeit.

The product named below fulfills the relevant fundamental requirements of the EC directives and standards listed. In the case of unauthorized modifications to the product or an unintended use this declaration becomes invalid.

Produktbezeichnung, Product name:

Thermomixer comfort 5355

einschließlich Zubehör / including accessories

Produkttyp, Product type:

Thermomixer für Reaktionsgefäße / Thermomixer for micro test tubes

Einschlägige EG-Richtlinien/Normen, Relevant EC directives/standards:

2006/95/EG, EN 61010-1, EN 61010-2-010, EN 61010-2-051

2004/108/EG, EN 55011/B, EN 61000-6-1, EN 61000-3-2, EN 61000-4-14



Vorstand, Board of Management:

05.11.2009

Hamburg, Date:



Projektmanagement, Project Management:



eppendorf

Eppendorf AG · Barkhausenweg 1 · 22339 Hamburg · Germany

Eppendorf offices

AUSTRALIA & NEW ZEALAND

Eppendorf South Pacific Pty. Ltd.
Telefon: +61 2 9889 5000
Fax: +61 2 9889 5111
E-Mail: Info@eppendorf.com.au
Internet: www.eppendorf.com.au

AUSTRIA

Eppendorf Austria GmbH
Telefon: +43 (0) 1 890 13 64 - 0
Fax: +43 (0) 1 890 13 64 - 20
E-Mail: office@eppendorf.at
Internet: www.eppendorf.at

BRAZIL

Eppendorf do Brasil Ltda.
Telefon: +55 11 30 95 93 44
Fax: +55 11 30 95 93 40
E-Mail: eppendorf@eppendorf.com.br
Internet: www.eppendorf.com.br

CANADA

Eppendorf Canada Ltd.
Telefon: +1 905 826 5525
Fax: +1 905 826 5424
E-Mail: canada@eppendorf.com
Internet: www.eppendorfn.com

CHINA

Eppendorf China Ltd.
Telefon: +86 21 38560500
Fax: +86 21 38560555
E-Mail: market.info@eppendorf.cn
Internet: www.eppendorf.cn

CZECH REP. & SLOVAKIA

Eppendorf Czech & Slovakia s.r.o.
Telefon: +420 323 605 454
Fax: +420 323 605 454
E-Mail: eppendorf@eppendorf.cz
Internet: www.eppendorf.cz /
www.eppendorf.sk

FRANCE

Eppendorf France S.A.R.L.
Telefon: +33 1 30 15 67 40
Fax: +33 1 30 15 67 45
E-Mail: eppendorf@eppendorf.fr
Internet: www.eppendorf.fr

GERMANY

Eppendorf Vertrieb
Deutschland GmbH
Telefon: +49 2232 418-0
Fax: +49 2232 418-155
E-Mail: vertrieb@eppendorf.de
Internet: www.eppendorf.de

INDIA

Eppendorf India Limited
Telefon: +91 44 42 11 13 14
Fax: +91 44 42 18 74 05
E-Mail: info@eppendorf.co.in
Internet: www.eppendorf.co.in

ITALY

Eppendorf s.r.l.
Telefon: +390 2 55 404 1
Fax: +390 2 58 013 438
E-Mail: eppendorf@eppendorf.it
Internet: www.eppendorf.it

JAPAN

Eppendorf Co. Ltd.
Telefon: +81 3 5825 2363
Fax: +81 3 5825 2365
E-Mail: info@eppendorf.jp
Internet: www.eppendorf.jp

NORDIC

Eppendorf Nordic Aps
Telefon: +45 70 22 2970
Fax: +45 45 76 7370
E-Mail: nordic@eppendorf.dk
Internet: www.eppendorf.dk

SOUTH & SOUTHEAST ASIA

Eppendorf Asia Pacific Sdn. Bhd.
Telefon: +60 3 8023 2769
Fax: +60 3 8023 3720
E-Mail: eppendorf@eppendorf.com.my
Internet: www.eppendorf.com.my

SPAIN

Eppendorf Ibérica S.L.U.
Telefon: +34 91 651 76 94
Fax: +34 91 651 81 44
E-Mail: iberica@eppendorf.es
Internet: www.eppendorf.es

SWITZERLAND

Vaudaux-Eppendorf AG
Telefon: +41 61 482 1414
Fax: +41 61 482 1419
E-Mail: vaudaux@vaudaux.ch
Internet: www.eppendorf.ch

UNITED KINGDOM

Eppendorf UK Limited
Telefon: +44 1223 200 440
Fax: +44 1223 200 441
E-Mail: sales@eppendorf.co.uk
Internet: www.eppendorf.co.uk

USA

Eppendorf North America, Inc.
Telefon: +1 516 334 7500
Fax: +1 516 334 7506
E-Mail: info@eppendorf.com
Internet: www.eppendorfn.com

OTHER COUNTRIES

Internet: www.eppendorf.com/worldwide



Evaluate your operating manual

www.eppendorf.com/manualfeedback

eppendorf

In touch with life

Your local distributor: www.eppendorf.com/worldwide

Eppendorf AG · 22331 Hamburg · Germany · Tel: +49 40 538 01-0 · Fax: +49 40 538 01-556
E-Mail: eppendorf@eppendorf.com

Eppendorf North America, Inc. · 102 Motor Parkway, Suite 410 · Hauppauge, NY 11788-5178 · USA
Tel: +1 516 334 7500 · Toll free phone: +1 800 645 3050 · Fax: +1 516 334 7506 · E-Mail: info@eppendorf.com

Application Support

Europe, International: Tel: +49 1803 666 789 · E-Mail: support@eppendorf.com
North America: Tel: +1 800 645 3050 ext. 2258 · E-Mail: techserv@eppendorf.com
Asia Pacific: Tel: +60 3 8023 6869 · E-Mail: support_asiapacific@eppendorf.com