

Register your instrument!
www.eppendorf.com/myeppendorf



Eppendorf SOP

Standard Operating Procedure for Pipettes

Copyright© 2014 Eppendorf AG, Hamburg. All rights reserved, including graphics and images. No part of this publication may be reproduced without the prior permission of the copyright owner.

Eppendorf® and the Eppendorf logo are registered trademarks of Eppendorf AG, Hamburg, Germany.

Eppendorf® and the Eppendorf logo are registered trademarks of Eppendorf AG, Hamburg, Germany.

Biomaster®, Combitips®, Combitips advanced®, Eppendorf Reference®, Eppendorf Research®, Eppendorf Xplorer®, Multipette®, PICASO®, Varipette® and Varispenser® are registered trademarks of Eppendorf AG, Hamburg, Germany.

Registered trademarks and protected trademarks are not marked in all cases with ® or ™ in this manual.

Table of contents

1	Test and pipette conditions	6
1.1	Balances	6
1.1.1	Balance type	6
1.1.2	Accuracy	6
1.1.3	Minimum requirements for balances	6
1.2	Measuring station	7
1.2.1	Evaporation	7
1.2.2	Measuring station	7
1.2.3	Test room	7
1.2.4	Temperature differences	7
1.2.5	Test liquid	7
1.2.6	Operating Manual	7
2	Calibration	8
2.1	Scope of testing	8
2.1.1	Adjusting adjustable volume pipettes	8
2.1.2	Multi-channel pipettes	8
2.1.3	Multipette	8
2.1.4	Bottle-top dispenser and Top Buret	8
2.2	Measurement	9
2.2.1	Work method	9
2.2.2	Removing the test volume from the reservoir	9
2.2.3	Dispensing the test volume into the weighing vessel	9
3	Evaluation	10
3.1	Calculating the systematic error	10
3.2	Calculating the random error	10
4	Sterilization and cleaning	11
4.1	Sterilization	11
4.1.1	Reference and Biomaster	11
4.1.2	Research plus and Reference 2	11
4.1.3	Research and Research pro	11
4.1.4	Top Buret	12
4.1.5	Varipette and Multipette	12
4.1.6	Varispenser	12
4.1.7	Xplorer and Xplorer plus	12
4.2	Cleaning	12
5	Leakage check	13
5.1	Pipette leakage check	13

6	Troubleshooting	14
6.1	Potential error causes and corrections	14
7	Adjustment	15
7.1	General information	15
7.2	Adjusting adjustable-volume pipettes	15
7.2.1	Procedure	16
7.2.2	Biomaster	17
7.2.3	Reference variable	17
7.2.4	Reference 2 adjustable-volume	18
7.2.5	Research variable	21
7.2.6	Research plusadjustable volume - adjustment to environmental parameters	22
7.2.7	Research plus adjustable volume - change to the factory adjustment	23
7.2.8	Research Multi-channel	28
7.2.9	Research plus Multi-channel	28
7.2.10	Varispenser plus	29
7.2.11	Xplorer and Xplorer plus	29
7.3	Adjusting fixed-volume pipettes	30
7.3.1	Reference fixed	30
7.3.2	Reference2	31
7.3.3	Research fixed	31
7.3.4	Research plus fixed	32
7.4	Physical influences of liquids	32
8	Factor Z for distilled water	33
8.1	Factor Z overview table	33
9	Technical specifications	34
9.1	Fixed-volume pipettes	34
9.1.1	Reference fixed	34
9.1.2	Reference 2 fixed	35
9.1.3	Research fixed	36
9.1.4	Research plus fixed	36
9.2	Adjusting adjustable volume pipettes	37
9.2.1	Reference variable	37
9.2.2	Reference 2 adjustable-volume	38
9.2.3	Research adjustable-volume	40
9.2.4	Research pro	41
9.2.5	Research plus adjustable-volume	42
9.2.6	Biomaster	43
9.2.7	Varipette	43
9.2.8	Xplorer and Xplorer plus	44

9.3	Multi-channel pipettes	45
9.3.1	Research	45
9.3.2	Research pro	46
9.3.3	Research plus	46
9.3.4	Reference2	47
9.3.5	Xplorer and Xplorer plus	48
9.4	Multipette	48
9.4.1	Multipette plus	49
9.4.2	Multipette M4	50
9.4.3	Multipette stream / Multipette Xstream	51
9.5	Varispenser / Top Buret	52
9.5.1	Varispenser and Varispenser plus	52
9.5.2	Top Buret	52
9.6	Error limits in accordance with EN ISO 8655	53
9.6.1	Air-cushion pipettes, fixed and adjustable volume	53
9.6.2	Positive displacement pipettes (Biomaster)	54
9.6.3	Dispenser (Multipette)	55
9.6.4	Single-stroke dispenser (Varispenser)	56
9.6.5	Piston stroke burets	56
	Index	57

1 **Test and pipette conditions**



These test and pipetting conditions are valid for all Eppendorf pipettes and dispensers.

Follow EN ISO 8655 "Volume-measuring equipment with pistons".

For the calibration or adjustment of pipettes, the scales and measuring station should fulfill the following requirements:

1.1 Balances

1.1.1 Balance type

Use semi-microbalances and microbalances to calibrate pipettes.

Some companies offer balances that are specially designed to meet the requirements of pipette calibration, e.g. Sartorius and Mettler.

1.1.2 Accuracy

When selecting the balances, ensure that they are suitable for the accuracy of the pipette. This helps to ensure that deviations within a measuring series are recorded exactly for the assessment of the systematic and random measurement deviations in accordance with EN ISO 8655.

For a pipette volume of less than or equal to 10 μL , balances with a 6-digit display must be used. With larger volumes, balances with a 5-digit display are sufficient.

1.1.3 Minimum requirements for balances

Selected volume* of the pipette to be tested	Display resolution [mg]
1 μL – 10 μL	0.001
>10 μL – 100 μL	0.01
>100 μL – 1000 μL	0.1
>1 mL – 10 mL	0.1
>10 mL – 200 mL	1

* For practical reasons, the nominal volume can be used for the selection of the balances.

1.2 Measuring station

1.2.1 Evaporation

Take evaporation protection into account while carrying out the measurement.

With volumes < 50µL in particular, errors caused by the evaporation of the test liquid must be taken into consideration.

This can be ensured by using a liquid trap or other equipment to prevent evaporation.

1.2.2 Measuring station

For electronic measurement data processing, we recommend calibration software and accessories for your balance (PICASO, order no. 3113 004.001).

(see also EN ISO 8655, Part 6)

1.2.3 Test room

The tests should be carried out in a draft-free room under constant climatic conditions.

The test room should have a constant temperature between 15 °C and 30 °C and a constant relative humidity above 50 %.

1.2.4 Temperature differences

Before the test, the device to be tested and test liquid must have stood in the test room for a sufficient amount of time, at least 2 hours, in order to reach equilibrium with the storage conditions.

Direct sunlight and other influences which could affect the temperature should be avoided at all costs.

1.2.5 Test liquid

Distilled or deionized water of "Quality 3 in accordance with ISO 3696", degassed or at equilibrium with air. The water must be at room temperature.

1.2.6 Operating Manual

Observe the operating instructions for your pipette.

2 **Calibration**

2.1 Scope of testing

Note concerning the nominal volume:

The nominal volume of an adjustable-volume pipette is the largest volume to be set by the user and specified by the manufacturer.

When using the Combitip with the Multipette, the nominal volume is the largest possible dispensing volume of the Combitip. This means that for the Multipette plus and Multipette M4, the nominal volume is 1/5 of the filling volume of the Combitip advanced. For the Multipette stream / Xstream, the nominal volume is the filling volume of the Combitip advanced.

2.1.1 Adjusting adjustable volume pipettes

For variable pipettes, check **3 different volumes** with 10 measured values each:

- the nominal volume,
- approx. 50 % of the nominal volume,
- 10 % of the nominal volume.

2.1.2 Multi-channel pipettes

For Multi-channel pipettes check **each channel separately** with 3 different volumes, each with 10 measured values:

- the nominal volume,
- approx. 50 % of the nominal volume,
- 10 % of the nominal volume.

2.1.3 Multipette

With the

- Multipette,
- Multipetteplus,
- Multipette stream,
- MultipetteXstream,
- MultipetteM4

check the nominal volume with 10 measured values with the Eppendorf Combitip used.

2.1.4 Bottle-top dispenser and Top Buret

For bottle-top dispensers and the Top Buret, check the nominal volume with 10 measured values.

2.2 Measurement

2.2.1 Work method

1. Place the selected pipette tip on the tip cone of the pipette or on the corresponding Combitip in the Multipipette.
2. Implement the following settings:
 - Adjustable-volume piston-stroke pipettes: the smallest volume to be tested
 - Multipipettes: the nominal volume
 - Bottle-top dispenser and Top Buret: the nominal volume
3. For all Multipipettes with fully drawn up Combitip, always discard the first dispensing step.
4. Fill test liquid up to a height of min. 3 mm in the weighing vessel.
5. For piston-stroke pipettes fill the pipette tip 5x with test liquid and empty it (pre-wet), in order to create a moisture balance in the dead air volume.
6. Replace the single-use tip.
7. Pre-wet the tip 1x.

2.2.2 Removing the test volume from the reservoir

1. Hold the pipette vertically.
2. Dip the pipette tip into the test liquid by a few millimeters.
3. Draw in the volume to be tested slowly and evenly. The waiting time of 1 to 3 seconds, for Research 1 to 10 mL 5 seconds must be observed. (the waiting time corresponds to the size of the tip, see operating instructions.)
4. Pull the pipette tip slowly out of the liquid, wiping it on the vessel wall.

2.2.3 Dispensing the test volume into the weighing vessel

1. Rest the filled tip up against the wall of the weighing vessel at an angle.
2. Dispense the test liquid slowly until the first stop (measuring stroke).
3. Press the control button to the second stop (blow-out) and dispense the remaining liquid in the tip (does not apply for dispensers and burets).
4. Hold down the control button and pull the tip up the vessel wall.
5. Let the control button slide back into position.
6. Determine the weight.
7. Complete all measurements of a measuring series as described and calculate the systematic and random error (see p. 10).
8. In case of adjustable-volume pipettes, determine the measurement with the nominal volume, 50 % and 10 % of the nominal volume. Always begin the test with 10 % of the nominal volume.

3 Evaluation

3.1 Calculating the systematic error

Mean value of the dispensed volume:

$$\bar{x} = \frac{\sum \text{All measured values}}{n} \cdot Z$$

n = Number of measured values

To convert the measured values into volume values, use correction factor Z for the dependency of the test liquid on temperature and air pressure for each individual value (see *Factor Z for distilled water on p. 33*).

Systematic error e_s in micro liter:

$$e_s = \bar{x} - x_{\text{nominal}}$$

Systematic error e_s in percent:

$$e_s = 100 \frac{(\bar{x} - x_{\text{nominal}})}{x_{\text{nominal}}}$$

3.2 Calculating the random error

Random error as repeat standard s :

$$s = \sqrt{\frac{\sum (x_i \cdot Z - \bar{x})^2}{n - 1}}$$

Random error as coefficient of variation CV:

$$CV (\%) = \frac{s}{\bar{x}} \cdot 100$$

The specifications of the tested pipette can be found in the relevant operating instructions or technical specifications (see *Technical specifications on p. 34*).

4 Sterilization and cleaning



Further notes on cleaning and sterilization can be found in the relevant operating manual.

4.1 Sterilization

Parameter for autoclaving

- 121 °C
- 20 minutes
- 1 bar overpressure

4.1.1 Reference and Biomaster

The Reference pipettes and the Biomaster are fully autoclavable.

1. Prior to autoclaving, unscrew the upper and lower part of the pipette apart by approx. one turn to enable the vapor to enter more easily.
2. After autoclaving, allow the pipette to cool down to room temperature and to dry completely and then screw together.

4.1.2 Research plus and Reference 2

The Research plus pipettes and Reference 2 pipettes are fully autoclavable.

1. You can put the Research plus and Reference 2 into the autoclave as a complete unit or with the lower part removed. Do not disassemble the lower part.
2. For 2.5 mL, 5 mL and 10 mL pipettes: remove the old protection filter. Add a new protection filter and install it after autoclaving. Only autoclave the protection filter once.
After autoclaving:
3. Cool the pipette down to room temperature and leave to dry.
4. For 2.5 mL, 5 mL / 10 mL pipettes: the protection filter swells during autoclaving. Slightly squeeze the protection filter when installing it into the cone tip.

4.1.3 Research and Research pro

With the Research and Research pro pipettes, the lower section is autoclavable.

With single-channel models prior to autoclaving

1. Pull off the ejector sleeve with depressed ejector.
2. Unscrew the lower part of the pipette.

With the Multi-channel versions, you can autoclave the entire lower section.

After autoclaving, assemble the parts only after room temperature has been reached and the parts have been dried.

4.1.4 Top Buret

The Top Buret can not be autoclaved.

4.1.5 Varipette and Multipette

The

- Varipette,
- Multipette,
- Multipetteplus,
- Multipette stream,
- MultipetteXstream,
- MultipetteM4

are not autoclavable.

4.1.6 Varispenser

The Varispenser and Varispenser plus are only autoclavable when fully assembled.

With the Varispenser plus

1. Set the discharge valve toggle to the dispensing position (→).
2. Release the volume setting knob, move to the middle position and leave released.
3. Place the dispenser on a cloth and autoclave, avoiding contact with hot surfaces.
4. Only use the dispenser again when it has cooled down to room temperature.

4.1.7 Xplorer and Xplorer plus

The lower part of the Xplorer and Xplorer plus pipettes can be autoclaved.

1. Pull off the ejector sleeve with depressed ejector.
2. On the lower part of the pipette, push the ring labeled **PUSH UP TO RELEASE** upward until the lower part is released.

After autoclaving, assemble the parts only after room temperature has been reached and the parts have been dried.

4.2 Cleaning



All areas of the underside of the pipette can be cleaned in a soap solution or isopropanol 60 % provided that no differing instructions are given in the operating manual.

1. Clean the parts in soap solution or isopropanol.
2. Rinse the parts in distilled water.
3. Allow the parts to dry completely and then assemble.
4. Lightly lubricate the piston of the pipette (Eppendorf special grease)

5 Leakage check

5.1 Pipette leakage check

In order to carry out a leakage check on a pipette, follow the procedure outlined below:

1. For adjustable-volume pipettes: set the nominal volume.
2. For volumes < 20 μL pre-wet the tip several times.
3. Hold the pipette vertically with a full tip for approx. 15 seconds. Do not touch the pipette tip.
4. Observe the meniscus of the liquid on the tip opening. If there is a leak in the pipette, a drip will form on the tip opening.

6 Troubleshooting

6.1 Potential error causes and corrections



Observe the error descriptions in the operating instructions.

Error	Cause	Elimination
Droplets on the inner wall of the pipette tip.	Uneven wetting of the plastic wall.	▶ Attach a new pipette tip.
Pipette is dripping, pipetted volume is incorrect.	<ul style="list-style-type: none"> • Tip loose. • Incorrect pipette tip. 	<ul style="list-style-type: none"> ▶ Press the tip on firmly. ▶ Use an original Eppendorf tip.
	Pipette is leaking because: <ul style="list-style-type: none"> • The piston is contaminated. • The piston is damaged. • The seal is damaged. 	<ul style="list-style-type: none"> ▶ Clean the piston and lubricate slightly. ▶ Replace the piston and piston sealing and lubricate slightly. ▶ Replace the seal.
Liquid cannot be aspirated correctly or dripping occurs.	<ul style="list-style-type: none"> • Leakage in the Combipip advanced. • Combipip advanced has heated up. 	<ul style="list-style-type: none"> ▶ Replace the Combipip advanced with a new Combipip advanced. ▶ Ensure that the temperature is uniform as the liquid expands when heated.
The control button is jammed, runs jerky.	<ul style="list-style-type: none"> • The piston is contaminated. • The seal is contaminated. • The piston is damaged. • Penetration of solvent vapors 	<ul style="list-style-type: none"> ▶ Clean the piston and lubricate slightly. ▶ Disassemble the pipette, clean all seals, replace if necessary. ▶ Replace the piston and piston seal and lubricate slightly. ▶ Unscrew the lower part of the pipette and aerate the lower part. ▶ Clean the piston and lubricate slightly.

7 Adjustment

7.1 General information

Prior to delivery, all pipettes are adjusted with distilled or de-ionized, degassed water under the conditions described in Chapters 1 to 3 and according to ISO 3696 (see *Calibration on p. 8*).

If you have doubts regarding the accuracy of the volume entered, please check the following points first:

- Is there a leak in the device (see *Leakage check on p. 13*)?
Exception: Biomaster
- Does the temperature of the pipetted liquid correspond to:
 - the temperature of the device?
 - the ambient air temperature?
- Is the set volume correct?
- Has the liquid density and air pressure been taken into consideration?
- Does the density of the pipetted liquid deviate from the double-distilled, degassed water?
- Was the work completed correctly, as described in the "Calibration" chapter (see p. 8) and "Evaluation" chapter (see p. 10)?
- Were original Eppendorf pipette tips used?

Volume errors can also occur when pipetting liquids with high vapor pressure, where the density or viscosity deviates considerably from the values of water.

Adjustments should only be carried out on the device after these conditions have been taken into consideration.

7.2 Adjusting adjustable-volume pipettes



Observe the operating instructions for your pipette. There you will find detailed descriptions on adjustment.

The adjustment of the following adjustable-volume pipettes is a zero point offset:

- Research
- Research plus
- Reference
- Biomaster
- Reference2

7.2.1 Procedure

Requirements

Device, original Eppendorf tip, test liquid and ambient air must have the same temperature (15 °C – 30 °C) at a constant temperature of ± 0.5 °C during the test (according to EN ISO 8655, Part 6).



If your Research, Research plus or Reference has an adjustment, remove it before carrying out the adjustment.

After adjusting, lock the adjustment opening with a new adjustment seal.

Adjustment seals can be reordered (see operating manual).

1. Set the pipette to the smallest volume to be tested.
2. Use a matching original Eppendorf tip for single-channel pipettes. For Multi-channel pipettes, use any channel.
3. Pipette the set volume 10 times.
4. Conduct a weighing after every volume dispensing.
5. Calculate the mean value after 10 measurements (see *Evaluation on p. 10*).
The calculated mean value of these weighings (observe conversion factor $Z = \text{mg to } \mu\text{L}$) yields the actual volume.
6. For adjusting, introduce the suitable tool into the opening intended for this purpose, or place it on the designated location, and adjust the actual volume (see the following figures or operating manual).
7. Check the set volume by measuring again. If the target volume does not match the result of the measurement, repeat steps 2 to 6.
8. After the adjustment, check the measured values for accuracy at 50 % of the nominal volume and check the nominal volume for accuracy.

7.2.2 Biomaster

Auxiliary equipment

- Supplied pipette wrench (order no. 4910 092.001)

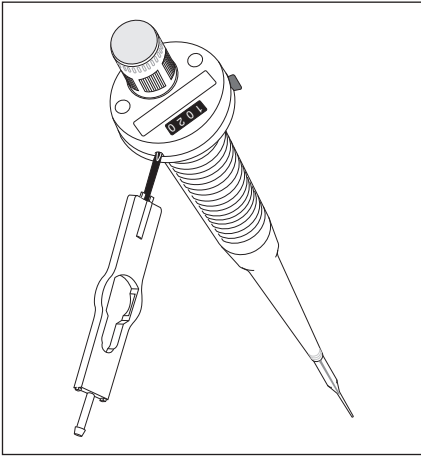

1. Use the pipette wrench to adjust the volume display of the pipette, with the piston stroke unchanged, to the actual volume value of the measurement.
2. Pull off the pipette wrench.
3. Set the pipette to the target volume in the usual manner.
4. Mark the adjustment on the pipette.

7.2.3 Reference variable

Auxiliary equipment

- Supplied pipette wrench (order no. 4910 092.001)
- Supplied red CAL seal

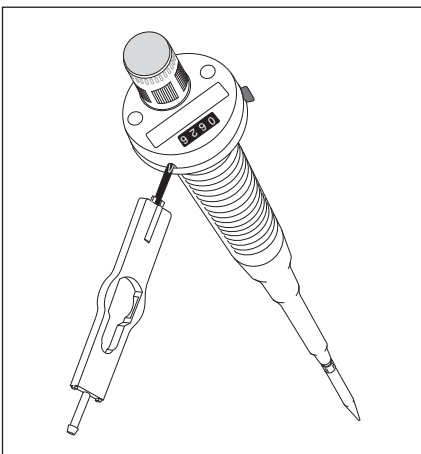

1. Insert side B of the pipette wrench into the adjustment opening in the lid.
2. Using the pipette wrench, set the digital display of the pipette, with unaltered piston stroke, to the actual volume value of the measurement.
3. Pull off the pipette wrench.
4. Set the pipette to the target volume in the usual manner.
5. After the adjustment has been successfully completed, lock the adjustment opening with a red CAL seal.

7.2.4 Reference 2 adjustable-volume

7.2.4.1 User adjustment

Changing the adjustment will change the volume by a specific value. Strictly speaking, the change only applies to the testing volume.

Example:

You readjust a 10 – 100 μL pipette, with a volume setting of 100 μL , by 1 μL (1 $\mu\text{L} \triangleq 1\%$). If the volume setting is 10 μL , the pipette is also adjusted by 1 μL ($\triangleq 10\%$).

Auxiliary aids from the delivery package

- Pin
- Red plastic adjustment seal (ADJ)

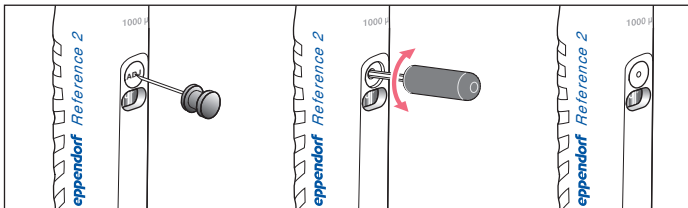

1. Insert the pin in the middle of the gray adjustment seal (ADJ).
2. Remove the adjustment seal.
3. Insert the adjustment tool.
4. Turn the adjustment tool until the adjustment display shows the desired value.
5. Read the set value distortion-free using the aligning aid in the viewing window.
6. Carry out weighings to check the accuracy and precision.

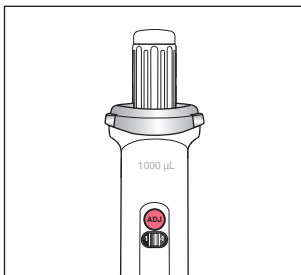

7. Attach the red adjustment seal after the inspections.

If the adjustment only applies to a specific liquid, mark the pipette accordingly. Use the labeling area on the pipette and mark it with the liquid and the volume. Carry out a gravimetric test for each adjustment change. Follow the EN ISO 8655-2 and EN ISO 8655-6 test procedures.

7.2.4.2 Changing the factory adjustment

Auxiliary aids from the delivery package

- Red plastic safety plug
- Pin

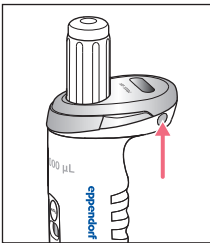

The factory adjustment can be changed using the corresponding accessories.

The factory adjustment will be marked by a safety plug. The color of the safety plug indicates the implementing authority:

- Gray - Eppendorf AG
- Red - User

The random and systematic errors recorded on delivery can be found in the *Eppendorf Certificate*. This certificate is included in delivery. The certificate is no longer valid if the default settings have been changed.

If the dispensing accuracy is only to be changed temporarily, the correct method is to change the user adjustment. Before changing the user or factory adjustment, observe the general notes and the associated gravimetric tests.

For the factory setting, the volume display will be set to match the piston stroke and the detected actual volume. If a gravimetric test indicates that an error needs to be corrected and you will be required to change to factory adjustment, proceed as follows:

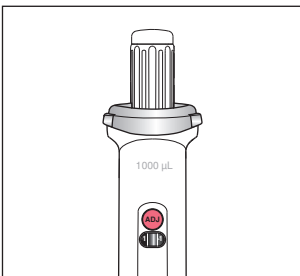

1. Check whether the adjustment display is set to "0".

If the adjustment display is not set to "0", it must be set to "0" first using the adjustment tool. In this case, instead of continuing with the factory adjustment changes, carry out a gravimetric test of the Reference2 with the adjustment display set to "0".

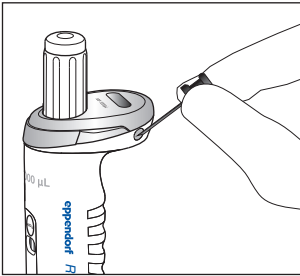

2. Use the plug to pierce the safety plug, and remove it.

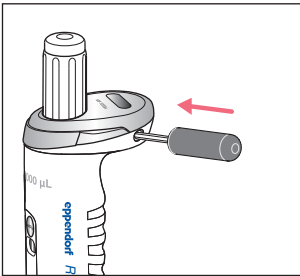

3. Insert the adjustment tool.

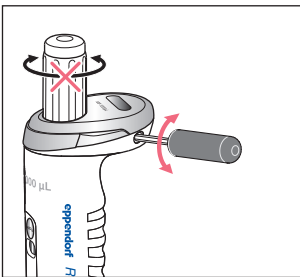

4. Hold the control button with one hand.

5. Turn the adjustment tool to set the volume display. Set the volume display (from the volume setting used during the inspection to the calculated volume of the gravimetric test).

The volume change applies to the entire volume range. For the volume change, you should initially set the value for 10% of the nominal volume of the value calculated during the gravimetric test. Then carry out gravimetric tests to check 50% and 100% of the nominal volume with this setting. If necessary, change the selected setting again to achieve the best possible correction for all volumes. Use the error limits in

accordance with ISO 8655-2 and the technical data provided by Eppendorf AG to decide whether the data obtained meets your requirements.

6. Carry out a gravimetric check of the changes that have been completed.

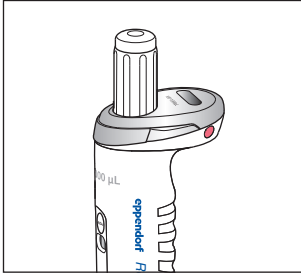

7. Insert the red safety plug into the adjustment opening.
The red safety plug on the pipette indicates that the pipette has been adjusted and calibrated by the user.

8. Record executed changes and measurements.

7.2.5 Research variable

Auxiliary equipment

- Supplied pipette wrench (order no. 3111 501.016)
- Supplied red CAL seal

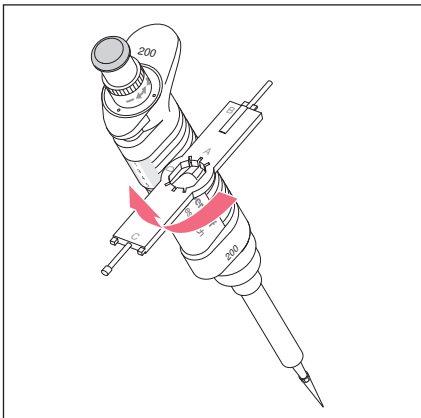

1. Insert side D of the pipette wrench vertically into the lateral adjustment opening of the pipette grip.
2. Move the pipette wrench into the vertical position.
3. Turn the volume setting ring toward – or +.
This adjusts the piston stroke of the pipette. The digital display does not change in the process.

4. A revolution corresponds to:

Volume range	Vol. /turn
0.1 μL – 2.5 μL	approx. 0.1 μL
0.5 μL – 10 μL	approx. 0.5 μL
2 μL – 20 μL	approx. 1 μL
10 μL – 100 μL	approx. 5 μL
20 μL – 200 μL	approx. 10 μL
100 μL – 1000 μL	approx. 50 μL
500 μL – 5000 μL	approx. 250 μL
1 μL – 10 mL	approx. 510 μL

5. Pull off the pipette wrench.

6. Move the volume setting ring slightly forwards and backwards so that the counting and stroke systems engage again.

7. After the adjustment has been successfully completed, lock the adjustment opening with a red CAL seal.

7.2.6 Research plusadjustable volume - adjustment to environmental parameters

Adjustment change for specific liquid densities, changed altitudes or pipette tips that are not used to calculate the random and systematic error.

The Research plus was adjusted, tested and fitted with a gray adjustment seal with the abbreviation "ADJ" before delivery. The adjustment display on the side reads "0". Changing the adjustment will change the volume by a specific value. Strictly speaking, the change only applies to the testing volume.

Auxiliary equipment

- Supplied adjustment tool (order no. 3120 633.006)
- Supplied red adjustment seal (ADJ)

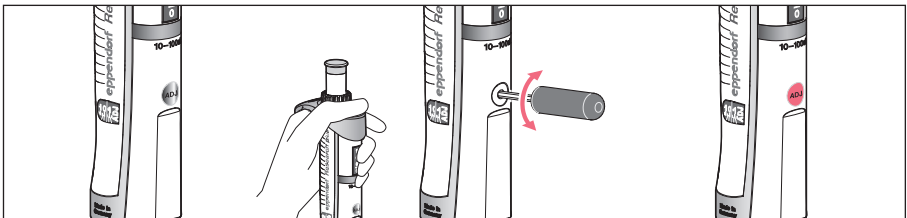

1. Remove the gray adjustment seal.
2. Keep the ejector pressed.
3. Insert the adjustment tool (from the delivery package).
4. Turn the adjustment tool until the adjustment display shows the desired value.

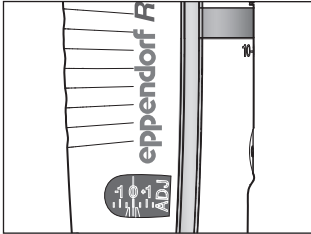

5. Place the Research plus on a horizontal surface (table). When completing the adjustment, look absolutely vertically at the window and read the set value via the backsight in the viewing window.

6. Carry out weighing procedures to check the accuracy and precision.
7. After the tests, close the opening with the red adjustment seal (from the delivery package).

If the adjustment only applies to a specific liquid, mark the pipette accordingly. Use the labeling area on the pipette and mark it with the liquid and the volume.

7.2.7 Research plus adjustable volume - change to the factory adjustment

Auxiliary equipment

- Supplied safety plug tool
- Supplied pin to loosen the safety plug

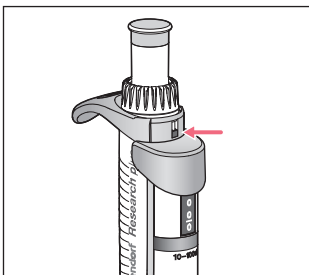

The factory adjustment can be changed with the corresponding accessories on a Research plus with variable volume setting.

You can recognize a change to the factory adjustment that was made by the user of the Research plus from the red safety plug behind the ejector. If the Research plus has been adjusted and calibrated by Eppendorf AG, this is indicated by a gray safety plug.

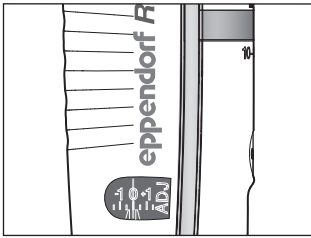

1. Check whether the adjustment display on the side is set to "0".

If the adjustment display is not set to "0", it must be set to "0" first using the adjustment tool. In this case, instead of continuing with the factory adjustment changes, carry out a gravimetric test of the Research plus with the adjustment display set to "0".

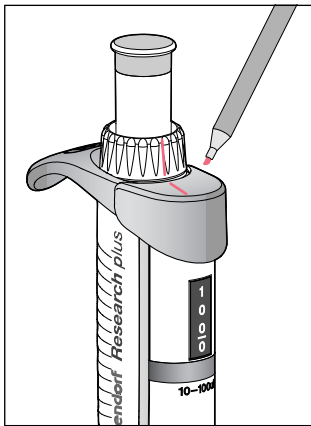

2. Provide the volume setting ring and the ejector with a common mark with a pen. This mark is used for orientation purposes when changing the factory adjustment. When changing the factory adjustment, you can turn the volume setting ring without changing the volume display. The mark on the volume setting ring and the ejector informs you how far you have moved from the factory setting.

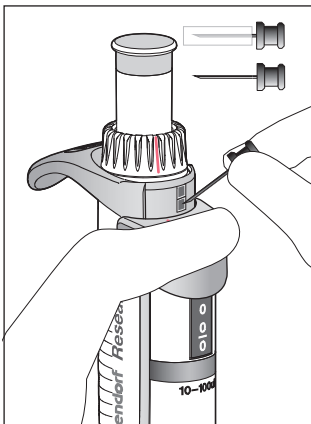

3. Keep the ejector pressed and remove the safety plug with the pin.

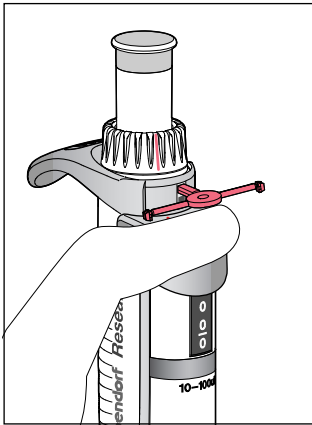

4. Continue to keep the ejector pressed. Insert the safety plug tool in such a way that the counter locking mechanism is pushed down.

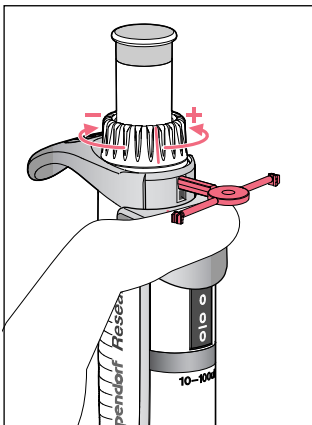

5. Turn the volume setting ring slightly to change the volume. Proceed as shown in the illustration.

6. This results in the following approximate volume changes:

single-channel				
Nominal volume Color code	+½ revolution	+¼ revolution	-¼ revolution	-½ revolution
2.5 µL Dark gray	0.106 µL	0.053 µL	-0.053 µL	-0.106 µL
10 µL Medium gray	0.53 µL	0.27 µL	-0.27 µL	-0.53 µL
20 µL light gray	1.06 µL	0.53 µL	-0.53 µL	-1.06 µL
20 µL Yellow	1.07 µL	0.54 µL	-0.54 µL	-1.07 µL
100 µL Yellow	5.4 µL	2.7 µL	-2.7 µL	-5.4 µL
200 µL Yellow	10.8 µL	5.4 µL	-5.4 µL	-10.8 µL
300 µL Orange	10.7 µL	5.4 µL	-5.4 µL	-10.7 µL
1000 µL Blue	54 µL	27 µL	-27 µL	-54 µL
5 mL Purple	271 µL	135 µL	-135 µL	-271 µL
10 mL Turquoise	542 µL	271 µL	-271 µL	-542 µL

multi-channel				
Nominal volume Color code	+½ revolution	+¼ revolution	-¼ revolution	-½ revolution
10 µL Medium gray	0.53 µL	0.27 µL	-0.27 µL	-0.53 µL
100 µL Yellow	5.4 µL	2.7 µL	-2.7 µL	-5.4 µL
300 µL Orange	10.7 µL	5.4 µL	-5.4 µL	-10.7 µL

The values mentioned are theoretical values and are for orientation purposes only. The volume changes mentioned apply to each volume setting.

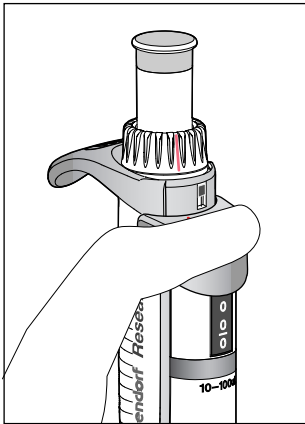

7. Push the locking mechanism upwards and carry out a gravimetric test of the changes made.

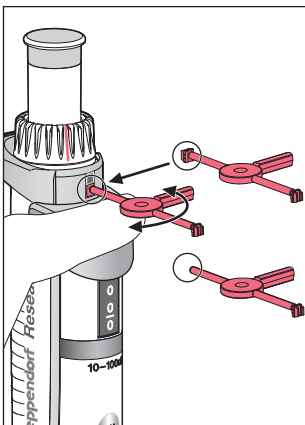

8. If the values measured during the gravimetric test meet your requirements: insert the red safety plug in the tool in the opening of the Research plus and snap it off the tool.
The red safety plug on the pipette indicates that the Research plus has been adjusted and calibrated by the user. If the adjustment display had also been set to "0" previously, you must close the opening with a new, red adjustment seal at the position for the adjustment seal.

9. Document the changes made and the measurements conducted. Remove the mark on the volume setting ring and on the ejector. The red safety plug on the pipette indicates that the Research plus has been adjusted and calibrated by the user.

7.2.8 Research Multi-channel

Auxiliary equipment

- Supplied pipette wrench (order no. 3111 501.016)
- Supplied red ADJ seal

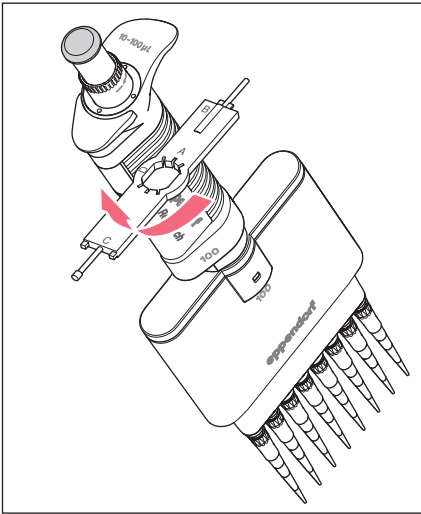

1. Insert the D side of the pipette wrench horizontally into the adjustment opening on the side of the pipette grip.
2. Move the pipette wrench into the vertical position.
3. Turn the volume setting ring toward – or +. This adjusts the piston stroke of the pipette. The digital display does not change in the process.

4. A revolution corresponds to:

Volume range	Vol./turn
0.5 μL – 10 μL	approx. 0.5 μL
10 μL – 300 μL	approx. 5 μL
30 μL	approx. 10 μL

5. Pull off the pipette wrench.
6. Move the volume setting ring slightly forwards and backwards so that the counting and stroke systems engage again.
7. After the adjustment has been successfully completed, lock the adjustment opening with a red ADJ-seal.

7.2.9 Research plus Multi-channel

Carry out the adjustment as described for the Research plus single-channel pipette (see p. 22).

7.2.10 Varispenser plus

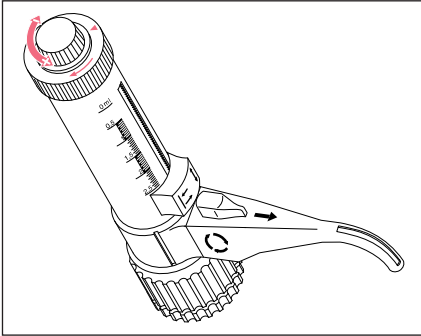

- ▶ Turn the fine adjustment toward + or -. A revolution corresponds to the smallest dispensing step:

Reduce volume:

- ▶ Turn toward -.

Increase volume:

- ▶ Turn toward +.

The factory adjustment was carried out at 20 °C, using double-distilled, degassed water.

7.2.11 Xplorer and Xplorer plus

- ❗ The re-adjustment of the Xplorer pipette is described on the CD which is enclosed with the pipette.



If you have selected a different adjustment in the Xplorer pipette options, a wrench symbol will be displayed in the header of the display.



Another symbol showing the selected adjustment is displayed to the right of the wrench symbol. If you are changing back to the factory adjustment at a later stage, the previously selected adjustment will be deleted and both symbols will disappear from the header.

7.3 Adjusting fixed-volume pipettes

The adjustment process for fixed-volume pipettes is identical to the adjustment process for variable pipettes (see *Adjusting adjustable-volume pipettes on p. 15*). For fixed-volume pipettes, 10 measured values of the nominal volume are checked.

7.3.1 Reference fixed

Auxiliary equipment

- Adhesive label as an adjusting aid for the basic setting
- Supplied pipette wrench (order no. 4910 092.001)

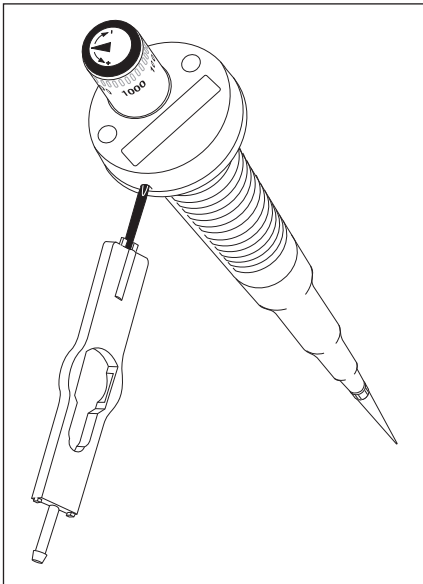

1. In order to simplify relocating the basic setting, attach the adhesive label supplied as an adjusting aid to the control button.
2. Using the B side of the pipette wrench, loosen the inside screw until the control button can be turned.
3. Set the control button to the calculated actual volume value of the measurement (see *Adjusting adjustable-volume pipettes on p. 15*).

One revolution of the control button corresponds to the following (based on water):

Reference fixed-volume	Vol./turn
1 µL, 2 µL, 5 µL, 10 µL	approx. 0.5 µL
10 µL, 20 µL	approx. 1 µL
25 µL, 50 µL	approx. 2.4 µL
100 µL	approx. 5 µL
200 µL, 250 µL	approx. 12 µL
500 µL, 1 000 µL	approx. 46 µL
1500 µL, 2000 µL, 2500 µL	approx. 118 µL

7.3.2 Reference2

Adjustment is carried out as described for the Reference 2 adjustable-volume (see p. 18).

7.3.3 Research fixed

Auxiliary equipment

- Supplied pipette wrench (order no. 3111 501.016)

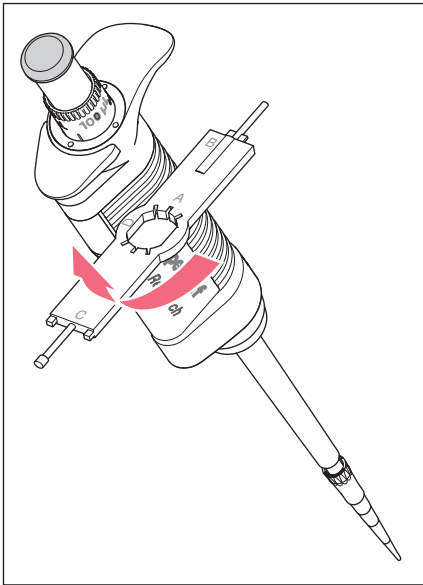

1. Insert side D of the pipette wrench vertically into the lateral adjustment opening of the pipette grip.
2. Move the tool into the vertical position.
3. Turn the volume setting ring toward – or +. This adjusts the piston stroke of the pipette.

With reference to water, one revolution of the volume setting ring corresponds to:

Volume range	Vol./turn
10 µL	approx. 0.8 µL
20 µL	approx. 0.8 µL
25 µL	approx. 0.8 µL
50 µL	approx. 0.8 µL
100 µL	approx. 0.8 µL
200 µL	approx. 38 µL
250 µL	approx. 38 µL
500 µL	approx. 38 µL
1000 µL	approx. 38 µL

7.3.4 Research plus fixed

Adjustment is carried out as described for the Research plus adjustable-volume (see p. 22).

7.4 Physical influences of liquids

It is possible to adjust the previously described devices for a volume of a liquid with a different density than water so that the displayed volume value corresponds to the pipetted volume.

-  With adjustable-volume pipettes, all other values are then readjusted, as the adjustable-volume pipette then becomes a fix-volume pipette.

The adjustment process is comparable to the described procedure (see p. 16). The difference is that the mean value of the weighings is converted to microliters according to the formula:

$$\text{Pipetting volume} = \frac{\text{Mean value of weighings}}{\text{Density of liquid weighed}}$$

1. Determine the mean value and convert it to microliters.
The calculated value is the nominal value.
2. The digital display of variable pipettes, or the volume of fix-volume pipettes, must be set to the calculated actual value.
3. Check the value set for the liquid gravimetrically. The accordingly set device only delivers a dispensing value, which corresponds to the digital display, for the used liquid and set volume.
4. If necessary correct and check the setting.
5. Label the measuring device following adjustment with the measured value and the name of the liquid which was used for the adjustment.

-  Following adjustment, the certificate accompanying the pipette becomes invalid.

8 Factor Z for distilled water

8.1 Factor Z overview table

Factor Z (µl/mg) in accordance with EN ISO 8655 for distilled water depending on test temperature and air pressure:

Temperature [°C]	Air pressure (kPa)						
	80	85	90	95	100	101.3	105
15	1.0017	1.0018	1.0019	1.0019	1.0020	1.0020	1.0020
15.5	1.0018	1.0019	1.0019	1.0020	1.0020	1.0020	1.0021
16	1.0019	1.0020	1.0020	1.0021	1.0021	1.0021	1.0022
16.5	1.0020	1.0020	1.0021	1.0021	1.0022	1.0022	1.0022
17	1.0021	1.0021	1.0022	1.0022	1.0023	1.0023	1.0023
17.5	1.0022	1.0022	1.0023	1.0023	1.0024	1.0024	1.0024
18	1.0022	1.0023	1.0023	1.0024	1.0025	1.0025	1.0025
18.5	1.0023	1.0024	1.0024	1.0025	1.0025	1.0026	1.0026
19	1.0024	1.0025	1.0025	1.0026	1.0026	1.0027	1.0027
19.5	1.0025	1.0026	1.0026	1.0027	1.0027	1.0028	1.0028
20	1.0026	1.0027	1.0027	1.0028	1.0028	1.0029	1.0029
20.5	1.0027	1.0028	1.0028	1.0029	1.0029	1.0030	1.0030
21	1.0028	1.0029	1.0029	1.0030	1.0031	1.0031	1.0031
21.5	1.0030	1.0030	1.0031	1.0031	1.0032	1.0032	1.0032
22	1.0031	1.0031	1.0032	1.0032	1.0033	1.0033	1.0033
22.5	1.0032	1.0032	1.0033	1.0033	1.0034	1.0034	1.0034
23	1.0033	1.0033	1.0034	1.0034	1.0035	1.0035	1.0036
23.5	1.0034	1.0035	1.0035	1.0036	1.0036	1.0036	1.0037
24	1.0035	1.0036	1.0036	1.0037	1.0037	1.0038	1.0038
24.5	1.0037	1.0037	1.0038	1.0038	1.0039	1.0039	1.0039
25	1.0038	1.0038	1.0039	1.0039	1.0040	1.0040	1.0040
25.5	1.0039	1.0040	1.0040	1.0041	1.0041	1.0041	1.0042
26	1.0040	1.0041	1.0041	1.0042	1.0042	1.0043	1.0043
26.5	1.0042	1.0042	1.0043	1.0043	1.0044	1.0044	1.0044
27	1.0043	1.0044	1.0044	1.0045	1.0045	1.0045	1.0046
27.5	1.0045	1.0045	1.0046	1.0046	1.0047	1.0047	1.0047
28	1.0046	1.0046	1.0047	1.0047	1.0048	1.0048	1.0048
28.5	1.0047	1.0048	1.0048	1.0049	1.0049	1.0050	1.0050
29	1.0049	1.0049	1.0050	1.0050	1.0051	1.0051	1.0051
29.5	1.0050	1.0051	1.0051	1.0052	1.0052	1.0052	1.0053
30	1.0052	1.0052	1.0053	1.0053	1.0054	1.0054	1.0054

9 Technical specifications

The following specifications are valid for the following conditions:

Liquid: Distilled or deionized water

Reference temperature: 20 °C to 25 °C ±0.5 °C

Number of determinations: 10, in accordance with EN ISO 8655 with original Eppendorf pipette tips



Technical specifications subject to change!

9.1 Fixed-volume pipettes

9.1.1 Reference fixed

Model	Test tip epT.I.P.S. Color code Volume range Length	Error limits			
		Error			
		Systematic error		Random error	
		± %	± µL	± %	± µL
1 µL	light gray 0.5 µL – 20 µL L 46 mm	±2.5	±0.025	±1.8	±0.018
2 µL		±2.0	±0.04	±1.2	±0.024
5 µL		±1.5	±0.075	±0.8	±0.04
10 µL		±1.0	±0.1	±0.5	±0.05
10 µL	Yellow 2 µL – 200 µL 53 mm	±1.0	±0.1	±0.5	±0.05
20 µL		±0.8	±0.16	±0.3	±0.06
25 µL		±0.8	±0.2	±0.3	±0.075
50 µL		±0.7	±0.35	±0.3	±0.15
100 µL		±0.6	±0.6	±0.2	±0.2
200 µL	Blue 50 µL – 1000 µL 71 mm	±0.6	±1.2	±0.2	±0.4
250 µL		±0.6	±1.5	±0.2	±0.5
500 µL		±0.6	±3.0	±0.2	±1.0
1000 µL		±0.6	±6.0	±0.2	±2.0
1500 µL	Red 500 µL – 2500 µL 115 mm	±0.6	±9.0	±0.2	±3.0
2000 µL		±0.6	±12	±0.2	±4.0
2500 µL		±0.6	±15	±0.2	±5.0

9.1.2 Reference 2 fixed

Reference2 Fixed volume					
Model	Test tip epT.I.P.S. color code Volume range Length	Maximum permissible errors Eppendorf AG			
		Error			
		Systematic error		Random error	
		± %	± µL	± %	± µL
1 µL	dark gray 0.1 µL – 10 µL 34 mm	±2.5	±0.025	±1.8	±0.018
2 µL		±2.0	±0.04	±1.2	±0.024
5 µL	medium gray 0.1 µL – 20 µL 40 mm	±1.2	±0.06	±0.6	±0.03
10 µL		±1.0	±0.1	±0.5	±0.05
20 µL	light gray 0.5 µL – 20 µL L 46 mm	±0.8	±0.16	±0.3	±0.06
10 µL	yellow 2 µL – 200 µL 53 mm	±1.2	±0.12	±0.6	±0.06
20 µL		±1.0	±0.2	±0.3	±0.06
25 µL		±1.0	±0.25	±0.3	±0.075
50 µL		±0.7	±0.35	±0.3	±0.15
100 µL		±0.6	±0.6	±0.2	±0.2
200 µL		±0.6	±1.2	±0.2	±0.4
200 µL		blue 50 µL – 1000 µL 71 mm	±0.6	±1.2	±0.2
250 µL	±0.6		±1.5	±0.2	±0.5
500 µL	±0.6		±3.0	±0.2	±1.0
1 000 µL	±0.6		±6.0	±0.2	±2.0

Reference2 Fixed volume					
Model	Test tip epT.I.P.S. color code Volume range Length	Maximum permissible errors Eppendorf AG			
		Error			
		Systematic error		Random error	
		± %	± mL	± %	± mL
2.0 mL	red 0.5 mL – 2.5 mL 115 mm	±0.6	±0.012	±0.2	±0.004
2.5 mL		±0.6	±0.015	±0.2	±0.005

9.1.3 Research fixed

Model	Test tip epT.I.P.S. Color code Volume range Length	Error limits			
		Error			
		Systematic error		Random error	
		± %	± µL	± %	± µL
10 µL	Yellow 2 µL – 200 µL 53 mm	±1.2	±0.12	±0.6	±0.06
20 µL		±1.0	±0.2	±0.3	±0.06
25 µL		±1.0	±0.25	±0.3	±0.075
50 µL		±0.7	±0.35	±0.3	±0.15
100 µL		±0.6	±0.6	±0.2	±0.2
200 µL	Blue 50 µL – 1000 µL 71 mm	±0.6	±1.2	±0.2	±0.4
250 µL		±0.6	±1.5	±0.2	±0.5
500 µL		±0.6	±3.0	±0.2	±1.0
1000 µL		±0.6	±6.0	±0.2	±2.0

9.1.4 Research plus fixed

Research plus fixed volume					
Model	Test tip epT.I.P.S. Color code Volume range Length	Eppendorf AG error limits			
		Error			
		Systematic error		Random error	
		± %	± µL	± %	± µL
10 µL	Medium gray 0.1 µL – 20 µL 40 mm	±1.2	±0.12	±0.6	±0.06
20 µL	light gray 0.5 µL – 20 µL L 46 mm	±0.8	±0.16	±0.3	±0.06
10 µL	Yellow 2 µL – 200 µL 53 mm	±1.2	±0.12	±0.6	±0.06
20 µL		±1.0	±0.2	±0.3	±0.06
25 µL		±1.0	±0.25	±0.3	±0.08
50 µL		±0.7	±0.35	±0.3	±0.15
100 µL		±0.6	±0.6	±0.2	±0.2
200 µL	Blue 50 µL – 1 000 µL 71 mm	±0.6	±1.2	±0.2	±0.4
250 µL		±0.6	±1.5	±0.2	±0.5
500 µL		±0.6	±3.0	±0.2	±1.0
1000 µL		±0.6	±6.0	±0.2	±2.0

9.2 Adjusting adjustable volume pipettes

9.2.1 Reference variable

Model	Test tip epT.I.P.S. Color code Volume range Length	Testing volume	Error limits			
			Error			
			Systematic error		Random error	
			± %	± µL	± %	± µL
0.1 µL – 2.5 µL	Dark gray 0.1 µL – 10 µL 34 mm	0.25 µL	±12.0	±0.03	±6.0	±0.015
		1.25 µL	±2.5	±0.031	±1.5	±0.019
		2.5 µL	±1.4	±0.035	±0.7	±0.018
0.5 µL – 10 µL	light gray 0.5 µL – 20 µL 46 mm	1 µL	±2.5	±0.025	±1.8	±0.018
		5 µL	±1.5	±0.075	±0.8	±0.04
		10 µL	±1.0	±0.1	±0.4	±0.04
2 µL – 20 µL	light gray 0.5 µL – 20 µL 46 mm	2 µL	±3.0	±0.06	±2.0	±0.04
		10 µL	±1.0	±0.1	±0.5	±0.05
		20 µL	±0.8	±0.16	±0.3	±0.06
2 µL – 20 µL	Yellow 2 µL – 200 µL 53 mm	2 µL	±5.0	±0.1	±1.5	±0.03
		10 µL	±1.2	±0.12	±0.6	±0.06
		20 µL	±1.0	±0.2	±0.3	±0.06
10 µL – 100 µL	Yellow 2 µL – 200 µL 53 mm	10 µL	±3.0	±0.3	±0.7	±0.07
		50 µL	±1.0	±0.5	±0.3	±0.15
		100 µL	±0.8	±0.8	±0.15	±0.15
50 µL – 200 µL	Yellow 2 µL – 200 µL 53 mm	50 µL	±1.0	±0.5	±0.3	±0.15
		100 µL	±0.9	±0.9	±0.3	±0.3
		200 µL	±0.6	±1.2	±0.2	±0.4
50 µL – 250 µL	Blue 50 µL – 1000 µL 71 mm	50 µL	±1.4	±0.7	±0.3	±0.15
		100 µL	±1.1	±1.1	±0.3	±0.3
		250 µL	±0.6	±1.5	±0.2	±0.5
100 µL – 1000 µL	Blue 50 µL – 1000 µL 71 mm	100 µL	±3.0	±3.0	±0.3	±0.3
		500 µL	±1.0	±5.0	±0.2	±1.0
		1000 µL	±0.6	±6.0	±0.2	±2.0
500 µL – 2500 µL	Red 500 µL – 2500 µL 115 mm	0.5 mL	±1.5	±7.5	±0.3	±1.5
		1.25 mL	±0.8	±10	±0.2	±2.5
		2.5 mL	±0.6	±15	±0.2	±5.0

9.2.2 Reference 2 adjustable-volume

Reference2 Single-channel variable						
Model	Test tip epT.I.P.S. color code Volume range Length	Testing volume	Maximum permissible errors Eppendorf AG			
			Error			
			Systematic error		Random error	
			± %	± µL	± %	± µL
0.1 µL – 2.5 µL Increment: 0.002 µL	dark gray 0.1 µL – 10 µL 34 mm	0.1 µL	±48.0	±0.048	±12.0	±0.012
		0.25 µL	±12.0	±0.03	±6.0	±0.015
		1.25 µL	±2.5	±0.031	±1.5	±0.019
		2.5 µL	±1.4	±0.035	±0.7	±0.018
0.5 µL – 10 µL Increment: 0.01 µL	medium gray 0.1 µL – 20 µL 40 mm	0.5 µL	±8.0	±0.04	±5.0	±0.0025
		1 µL	±2.5	±0.025	±1.8	±0.018
		5 µL	±1.5	±0.075	±0.8	±0.04
		10 µL	±1.0	±0.10	±0.4	±0.04
2 µL – 20 µL Increment: 0.02 µL	light gray 0.5 µL – 20 µL L 46 mm	2 µL	±5.0	±0.10	±1.5	±0.03
		10 µL	±1.2	±0.12	±0.6	±0.06
		20 µL	±1.0	±0.20	±0.3	±0.06
2 µL – 20 µL Increment: 0.02 µL	yellow 2 µL – 200 µL 53 mm	2 µL	±5.0	±0.10	±1.5	±0.03
		10 µL	±1.2	±0.12	±0.6	±0.06
		20 µL	±1.0	±0.2	±0.3	±0.06
10 µL – 100 µL Increment: 0.1 µL	yellow 2 µL – 200 µL 53 mm	10 µL	±3.0	±0.3	±0.7	±0.07
		50 µL	±1.0	±0.5	±0.3	±0.15
		100 µL	±0.8	±0.8	±0.2	±0.2
20 µL – 200 µL Increment: 0.2 µL	yellow 2 µL – 200 µL 53 mm	20 µL	±2.5	±0.5	±0.7	±0.14
		100 µL	±1.0	±1.0	±0.3	±0.3
		200 µL	±0.6	±1.2	±0.2	±0.4
30 µL – 300 µL Increment: 0.2 µL	orange 20 µL – 300 µL 55 mm	30 µL	±2.5	±0.75	±0.7	±0.21
		150 µL	±1.0	±1.5	±0.3	±0.45
		300 µL	±0.6	±1.8	±0.2	±0.6
100 µL – 1 000 µL Increment: 1 µL	blue 50 µL – 1 000 µL 71 mm	100 µL	±3.0	±3.0	±0.6	±0.6
		500 µL	±1.0	±5.0	±0.2	±1.0
		1000 µL	±0.6	±6.0	±0.2	±2.0

Reference2 Single-channel variable

Model	Test tip epT.I.P.S. color code Volume range Length	Testing volume	Maximum permissible errors Eppendorf AG			
			Error			
			Systematic error		Random error	
			± %	± mL	± %	± mL
0.25 mL – 2.5 mL Increment: 0.002 mL	red 0.25 mL – 2.5 mL 115 mm	0.25 mL	±4.8	±0.012	±1.2	±0.003
		1.25 mL	±0.8	±0.010	±0.2	±0.0025
		2.5 mL	±0.6	±0.015	±0.2	±0.005
0.5 mL – 5 mL Increment: 0.005 mL	violet 0.1 mL – 5 mL 120 mm	0.5 mL	±2.4	±0.012	±0.6	±0.003
		2.5 mL	±1.2	±0.030	±0.25	±0.006
		5.0 mL	±0.6	±0.030	±0.15	±0.0075
1 mL – 10 mL Increment: 0.01 mL	turquoise 1 mL – 10 mL 165 mm	1.0 mL	±3.0	±0.030	±0.6	±0.006
		5.0 mL	±0.8	±0.040	±0.2	±0.010
		10.0 mL	±0.6	±0.060	±0.15	±0.015

9.2.3 Research adjustable-volume

Model	Test tip epT.I.P.S. Color code Volume range Length	Testing volume	Error limits			
			Error			
			Systematic error		Random error	
			± %	± µL	± %	± µL
0.1 µL – 2.5 µL	Dark gray 0.1 µL – 10 µL 34 mm	0.25 µL	±12.0	±0.03	±6.0	±0.015
		1.25 µL	±2.5	±0.031	±1.5	±0.019
		2.5 µL	±1.4	±0.035	±0.7	±0.018
0.5 µL – 10 µL	light gray 0.5 µL – 20 µL L 46 mm	1 µL	±2.5	±0.025	±1.8	±0.018
		5 µL	±1.5	±0.075	±0.8	±0.04
		10 µL	±1.0	±0.1	±0.4	±0.04
2 µL – 20 µL	Yellow 2 µL – 200 µL 53 mm	2 µL	±5.0	±0.1	±1.5	±0.03
		10 µL	±1.2	±0.12	±0.6	±0.06
		20 µL	±1.0	±0.2	±0.3	±0.06
10 µL – 100 µL	Yellow 2 µL – 200 µL 53 mm	10 µL	±3.0	±0.3	±1.0	±0.1
		50 µL	±1.0	±0.5	±0.3	±0.15
		100 µL	±0.8	±0.8	±0.2	±0.20
20 µL – 200 µL	Yellow 2 µL – 200 µL 53 mm	20 µL	±2.5	±0.5	±0.7	±0.14
		100 µL	±1.0	±1.0	±0.3	±0.3
		200 µL	±0.6	±1.2	±0.2	±0.4
100 µL – 1000 µL	Blue 0.05 – 1 mL 71 mm	100 µL	±3.0	±3.0	±0.6	±0.6
		500 µL	±1.0	±5.0	±0.2	±1.0
		1000 µL	±0.6	±6.0	±0.2	±2.0
0.5 mL – 5 mL	Purple 0.1 – 5 mL 120 mm	0.5 mL	±2.4	±12	±0.6	±3.0
		2.5 mL	±1.2	±30	±0.25	±6.25
		5.0 mL	±0.6	±30	±0.15	±7.5
1 mL – 10 mL	Turquoise 1 – 10 mL 165 mm	1.0 mL	±3.0	±30	±0.6	±6.0
		5.0 mL	±0.8	±40	±0.2	±10
		10.0 mL	±0.6	±60	±0.15	±15

9.2.4 Research pro

Model	Test tip epT.I.P.S. Color code Volume range Length	Testing volume	Error limits			
			Error			
			Systematic error		Random error	
			± %	± µL	± %	± µL
0.5 µL – 10 µL	light gray 0.5 – 20 µL L 46 mm	1 µL	±2.5	±0.025	±1.8	±0.018
		5 µL	±1.5	±0.075	±0.8	±0.04
		10 µL	±1.0	±0.1	±0.4	±0.04
5 µL – 100 µL	Yellow 2 – 200 µL 53 mm	10 µL	±2.0	±0.2	±1.0	±0.1
		50 µL	±1.0	±0.5	±0.3	±0.15
		100 µL	±0.8	±0.8	±0.2	±0.2
20 µL – 300 µL	Orange 20 – 300 µL 55 mm	30 µL	±2.5	±0.75	±0.7	±0.21
		150 µL	±1.0	±1.5	±0.3	±0.45
		300 µL	±0.6	±1.8	±0.2	±0.6
50 µL – 1000 µL	Blue 50 – 1000 µL 71 mm	100 µL	±3.0	±3.0	±0.6	±0.6
		500 µL	±1.0	±5.0	±0.2	±1.0
		1000 µL	±0.6	±6.0	±0.2	±2.0
500 µL – 5000 µL	Purple 0.1 – 5 mL 120 mm	0.5 mL	±3.0	±15	±0.6	±3.0
		2.5 mL	±1.2	±30	±0.25	±6.25
		5.0 mL	±0.6	±30	±0.15	±7.5

9.2.5 Research plus adjustable-volume

Research plus adjustable single-channel						
Model	Test tip epT.I.P.S. Color code Volume range Length	Testing volume	Eppendorf AG error limits			
			Error			
			Systematic error		Random error	
			± %	± µL	± %	± µL
0.1 µL – 2.5 µL Increment: 0.002 µL	Dark gray 0.1 µL – 10 µL 34 mm	0.1 µL	±48	±0.048	±12	±0.012
		0.25 µL	±12	±0.03	±6.0	±0.015
		1.25 µL	±2.5	±0.031	±1.5	±0.019
		2.5 µL	±1.4	±0.035	±0.7	±0.018
0.5 µL – 10 µL Increment: 0.01 µL	Medium gray 0.1 µL – 20 µL 40 mm	0.5 µL	±8.0	±0.04	±5.0	±0.025
		1 µL	±2.5	±0.025	±1.8	±0.018
		5 µL	±1.5	±0.075	±0.8	±0.04
		10 µL	±1.0	±0.1	±0.4	±0.04
2 µL – 20 µL Increment: 0.02 µL	light gray 0.5 µL – 20 µL L 46 mm	2 µL	±5.0	±0.1	±1.5	±0.03
		10 µL	±1.2	±0.12	±0.6	±0.06
		20 µL	±1.0	±0.2	±0.3	±0.06
2 µL – 20 µL Increment: 0.02 µL	Yellow 2 µL – 200 µL 53 mm	2 µL	±5.0	±0.1	±1.5	±0.03
		10 µL	±1.2	±0.12	±0.6	±0.06
		20 µL	±1.0	±0.2	±0.3	±0.06
10 µL – 100 µL Increment: 0.1 µL	Yellow 2 µL – 200 µL 53 mm	10 µL	±3.0	±0.3	±1.0	±0.1
		50 µL	±1.0	±0.5	±0.3	±0.15
		100 µL	±0.8	±0.8	±0.2	±0.2
20 µL – 200 µL Increment: 0.2 µL	Yellow 2 µL – 200 µL 53 mm	20 µL	±2.5	±0.5	±0.7	±0.14
		100 µL	±1.0	±1.0	±0.3	±0.3
		200 µL	±0.6	±1.2	±0.2	±0.4
30 µL – 300 µL Increment: 0.2 µL	Orange 20 µL – 300 µL 55 mm	30 µL	±2.5	±0.75	±0.7	±0.21
		150 µL	±1.0	±1.5	±0.3	±0.45
		300 µL	±0.6	±1.8	±0.2	±0.6
100 µL – 1000 µL Increment: 1 µL	Blue 50 µL – 1000 µL 71 mm	100 µL	±3.0	±3.0	±0.6	±0.6
		500 µL	±1.0	±5.0	±0.2	±1.0
		1000 µL	±0.6	±6.0	±0.2	±2.0
0.5 µL – 5 mL Increment: 0.005 mL	Purple 0.1 µL – 5 mL 120 mm	0.5 mL	±2.4	±12	±0.6	±3.0
		2.5 mL	±1.2	±30	±0.25	±6.0
		5.0 mL	±0.6	±30	±0.15	±8.0

Research plus adjustable single-channel						
Model	Test tip epT.I.P.S. Color code Volume range Length	Testing volume	Eppendorf AG error limits			
			Error			
			Systematic error		Random error	
			± %	± µL	± %	± µL
1 µL – 10 mL Increment: 0.01 mL	Turquoise 1 µL – 10 mL 165 mm	1.0 mL	±3.0	±30	±0.6	±6.0
		5.0 mL	±0.8	±40	±0.2	±10
		10.0 mL	±0.6	±60	±0.15	±15

9.2.6 Biomaster

Model	Pipette tip	Testing volume	Error limits			
			Error			
			Systematic error		Random error	
			± %	± µL	± %	± µL
Biomaster 4830	Mastertip	2 µL	±6.0	±0.12	±4.0	±0.08
		3 µL	±5.0	±0.15	±3.0	±0.09
		5 µL	±4.0	±0.2	±2.0	±0.1
		10 µL	±3.0	±0.3	±1.5	±0.15
		20 µL	±2.5	±0.5	±0.8	±0.16

9.2.7 Varipette

Model	Pipette tip	Testing volume	Error limits			
			Error			
			Systematic error		Random error	
			± %	± mL	± %	± mL
Varipette 4720	Varitip S	2.5 mL	±1.0	±0.025	±0.2	±0.005
		5 mL	±0.4	±0.02	±0.2	±0.01
		10 mL	±0.3	±0.03	±0.2	±0.02
Varipette 4720	Varitip P	1 mL	±0.6	±0.006	±0.2	±0.002
		5 mL	±0.5	±0.025	±0.1	±0.005
		10 mL	±0.3	±0.03	±0.1	±0.01

9.2.8 Xplorer and Xplorer plus

Model	Test tip epT.I.P.S. color code Volume range Length	Testing volume	Error limits Eppendorf AG			
			Error			
			Systematic error		Random error	
			± %	± µL	± %	± µL
0.5 µL – 10 µL Increment: 0.01 µL	Medium gray 0.1 µL – 20 µL 40 mm	1 µL	± 2.5	± 0.025	± 1.8	± 0.018
		5 µL	± 1.5	± 0.075	± 0.8	± 0.04
		10 µL	± 1.0	± 0.1	± 0.4	± 0.04
5 µL – 100 µL Increment: 0.1 µL	Yellow 2 µL – 200 µL 53 mm	10 µL	± 2.0	± 0.2	± 1.0	± 0.1
		50 µL	± 1.0	± 0.5	± 0.3	± 0.15
		100 µL	± 0.8	± 0.8	± 0.2	± 0.2
15 µL – 300 µL Increment: 0.2 µL	Orange 15 µL – 300 µL 55 mm	30 µL	± 2.5	± 0.75	± 0.7	± 0.21
		150 µL	± 1.0	± 1.5	± 0.3	± 0.45
		300 µL	± 0.6	± 1.8	± 0.2	± 0.6
50 µL – 1000 µL Increment: 1 µL	Blue 50 µL – 1000 µL 71 mm	100 µL	± 3.0	± 3.0	± 0.6	± 0.6
		500 µL	± 1.0	± 5.0	± 0.2	± 1
		1000 µL	± 0.6	± 6.0	± 0.2	± 2
0.2 mL – 5 mL Increment: 0.005 mL	Violet 0.1 mL – 5 mL 120 mm	0.5 mL	± 3.0	± 15.0	± 0.6	± 3
		2.5 mL	± 1.2	± 30.0	± 0.25	± 6.25
		5 mL	± 0.6	± 30.0	± 0.15	± 7.5
0.5 mL – 10 mL Increment: 0.01 mL	Turquoise 1 mL – 10 mL 165 mm	1 mL	± 3.0	± 30.0	± 0.60	± 6.0
		5 mL	± 0.8	± 40.0	± 0.20	± 10.0
		10 mL	± 0.6	± 60.0	± 0.15	± 15.0

9.3 Multi-channel pipettes
9.3.1 Research

Model	Test tip epT.I.P.S. Color code Volume range Length	Volume in μL	Error limits			
			Error			
			Systematic error		Random error	
			$\pm \%$	$\pm \mu\text{L}$	$\pm \%$	$\pm \mu\text{L}$
Research8-channel 0.5 μL – 10 μL	light gray 0.5 μL – 20 μL L 46 mm	1	± 8.0	± 0.08	± 5.0	± 0.05
		5	± 4.0	± 0.2	± 2.0	± 0.1
		10	± 2.0	± 0.2	± 1.0	± 0.1
Research12-channel 0.5 μL – 10 μL		see 8-channel				
Research8-channel 10 μL – 100 μL	Yellow 2 μL – 200 μL 53 mm	10	± 3.0	± 0.3	± 2.0	± 0.2
		50	± 1.0	± 0.5	± 0.8	± 0.4
		100	± 0.8	± 0.8	± 0.3	± 0.3
Research12-channel 10 μL – 100 μL		see 8-channel				
Research8-channel 30 μL – 300 μL	Orange 20 μL – 300 μL 55 mm	30	± 3.0	± 0.9	± 1.0	± 0.3
		150	± 1.0	± 1.5	± 0.5	± 0.75
		300	± 0.6	± 1.8	± 0.3	± 0.9
Research12-channel 30 μL – 300 μL		see 8-channel				

9.3.2 Research pro

Model	Test tip epT.I.P.S. Color code Volume range Length	Testing volume	Error limits			
			Error			
			Systematic error		Random error	
			± %	± µL	± %	± µL
Research pro 8-channel / 12-channel 0.5 µL – 10 µL	light gray 0.5 µL – 20 µL L 46 mm	1 µL	±5.0	±0.05	±3.0	±0.03
		5 µL	±3.0	±0.15	±1.5	±0.075
		10 µL	±2.0	±0.2	±0.8	±0.08
Research pro 8-channel / 12-channel 5 µL – 100 µL	Yellow 2 µL – 200 µL 53 mm	10 µL	±2.0	±0.2	±2.0	±0.2
		50 µL	±1.0	±0.5	±0.8	±0.4
		100 µL	±0.8	±0.8	±0.25	±0.25
Research pro 8-channel / 12-channel 20 µL – 300 µL	Orange 20 µL – 300 µL 55 mm	30 µL	±2.5	±0.75	±1.0	±0.3
		150 µL	±1.0	±1.5	±0.5	±0.75
		300 µL	±0.6	±1.8	±0.25	±0.75
Research pro 8-channel / 12-channel 50 µL – 1250 µL	Green 50 µL – 1250 µL 76 mm	120 µL	±6.0	±7.2	±0.9	±1.08
		600 µL	±2.7	±16.2	±0.4	±2.4
		1200 µL	±1.2	±14.4	±0.3	±3.6

9.3.3 Research plus

Research plus adjustable multi-channel

Model	Test tip epT.I.P.S. Color code Volume range Length	Testing volume	Eppendorf AG error limits			
			Error			
			Systematic error		Random error	
			± %	± µL	± %	± µL
0.5 µL – 10 µL Increment: 0.01 µL	Medium gray 0.1 µL – 20 µL 40 mm	0.5 µL	±12	±0.06	±8.0	±0.04
		1 µL	±8.0	±0.08	±5.0	±0.05
		5 µL	±4.0	±0.2	±2.0	±0.1
		10 µL	±2.0	±0.2	±1.0	±0.1
10 µL – 100 µL Increment: 0.1 µL	Yellow 2 µL – 200 µL 53 mm	10 µL	±3.0	±0.3	±2.0	±0.2
		50 µL	±1.0	±0.5	±0.8	±0.4
		100 µL	±0.8	±0.8	±0.3	±0.3

Research plus adjustable multi-channel						
Model	Test tip epT.I.P.S. Color code Volume range Length	Testing volume	Eppendorf AG error limits			
			Error			
			Systematic error		Random error	
			± %	± µL	± %	± µL
30 µL – 300 µL Increment: 0.2 µL	Orange 20 µL – 300 µL 55 mm	30 µL	±3.0	±0.9	±1.0	±0.3
		150 µL	±1.0	±1.5	±0.5	±0.75
		300 µL	±0.6	±1.8	±0.3	±0.9

9.3.4 Reference2

Reference2 Multi-channel variable (8-channel / 12-channel)						
Model	Test tip epT.I.P.S. color code Volume range Length	Testing volume	Maximum permissible errors Eppendorf AG			
			Error			
			Systematic error		Random error	
			± %	± µL	± %	± µL
0.5 µL – 10 µL	medium gray 0.1 µL – 20 µL 40 mm	0.5 µL	±12.0	±0.06	±8.0	±0.04
		1 µL	±8.0	±0.08	±5.0	±0.05
		5 µL	±4.0	±0.2	±2.0	±0.1
		10 µL	±2.0	±0.2	±1.0	±0.1
10 µL – 100 µL	yellow 2 µL – 200 µL 53 mm	10 µL	±3.0	±0.3	±2.0	±0.2
		50 µL	±1.0	±0.5	±0.8	±0.4
		100 µL	±0.8	±0.8	±0.3	±0.3
30 µL – 300 µL	orange 20 µL – 300 µL 55 mm	30 µL	±3.0	±0.9	±1.0	±0.3
		150 µL	±1.0	±1.5	±0.5	±0.75
		300 µL	±0.6	±1.8	±0.3	±0.9

9.3.5 Xplorer and Xplorer plus

Model Increment	Test tip epT.I.P.S. color code Volume range Length	Testing volume	Error limits Eppendorf AG			
			Error			
			Systematic error		Random error	
			± %	± µL	± %	± µL
0.5 µL – 10 µL Increment: 0.01 µL	Medium gray 0.1 – 20 µL 40 mm	1 µL	± 5.0	± 0.05	± 3.0	± 0.03
		5 µL	± 3.0	± 0.15	± 1.5	± 0.075
		10 µL	± 2.0	± 0.2	± 0.8	± 0.08
5 µL – 100 µL Increment: 0.1 µL	Yellow 2 – 200 µL 53 mm	10 µL	± 2.0	± 0.2	± 2.0	± 0.2
		50 µL	± 1.0	± 0.5	± 0.8	± 0.4
		100 µL	± 0.8	± 0.8	± 0.25	± 0.25
15 µL – 300 µL Increment: 0.2 µL	Orange 15 – 300 µL 55 mm	30 µL	± 2.5	± 0.75	± 1.0	± 0.3
		150 µL	± 1.0	± 1.5	± 0.5	± 0.75
		300 µL	± 0.6	± 1.8	± 0.25	± 0.75
50 µL – 1200 µL Increment: 1 µL	Green 50 – 1250 µL 76 mm	120 µL	± 6.0	± 7.2	± 0.9	± 1.08
		600 µL	± 2.7	± 16.2	± 0.4	± 2.4
		1200 µL	± 1.2	± 14.2	± 0.3	± 3.6

9.4 Multipette

The following specifications for the Multipette plus, Multipette stream / Multipette Xstream, Multipette M4 apply to the following conditions:

- Using the Combitips advanced
- Liquid: Distilled or deionized water
- Reference temperature: 20 °C to 25 °C, ±0.5 °C
- Number of determinations: 10 according to EN ISO 8655, with the original Eppendorf Combitip advanced

Multipette stream / Multipette Xstream:

- Volume test in "DIS" mode
- Set speed level: 7

9.4.1 Multipette plus

Combitip advanced	Testing volume	Error limits			
		Error			
		Systematic error		Random error	
		± %	± µL	± %	± µL
0.1 mL (beige piston)	2 µL	±1.6	±0.032	±3.0	±0.06
	20 µL	±1.0	±0.2	±2.0	±0.4
0.2 mL (blue piston)	4 µL	±1.3	±0.052	±2.0	±0.08
	40 µL	±0.8	±0.32	±1.5	±0.6
0.5 mL	10 µL	±0.9	±0.09	±1.5	±0.15
	100 µL	±0.8	±0.8	±0.6	±0.6
1 mL	20 µL	±0.9	±0.18	±0.9	±0.18
	200 µL	±0.6	±1.2	±0.4	±0.8
2.5 mL	50 µL	±0.8	±0.4	±0.8	±0.4
	500 µL	±0.5	±2.5	±0.3	±1.5
5 mL	100 µL	±0.6	±0.6	±0.6	±0.6
	1000 µL	±0.5	±5.0	±0.25	±2.5
10 mL	200 µL	±0.5	±1.0	±0.6	±1.2
	2 000 µL	±0.5	±10	±0.25	±5.0
25 mL (blue adapter)	500 µL	±0.4	±2.0	±0.6	±3.0
	5000 µL	±0.3	±15	±0.25	±12.5
50 mL (Dark gray adapter)	1000 µL	±0.3	±3.0	±0.5	±5.0
	10000 µL	±0.3	±30	±0.3	±30

9.4.2 Multipipette M4

Combitip advanced	Testing volume	Error limits			
		Error			
		Systematic error		Random error	
		± %	± µL	± %	± µL
0.1 mL white Increment: 1 µL	2 µL	±1.6	±0.032	±3.0	±0.06
	20 µL	±1.0	±0.2	±2.0	±0.4
0.2 mL light blue Increment: 2 µL	4 µL	±1.3	±0.052	±2.0	±0.08
	40 µL	±0.8	±0.32	±1.5	±0.6
0.5 mL purple Increment: 5 µL	10 µL	±0.9	±0.09	±1.5	±0.15
	100 µL	±0.8	±0.8	±0.6	±0.6
1 mL yellow Increment: 10 µL	20 µL	±0.9	±0.18	±0.9	±0.18
	200 µL	±0.6	±1.2	±0.4	±0.8
2.5 mL green Increment: 25 µL	50 µL	±0.8	±0.4	±0.8	±0.4
	500 µL	±0.5	±2.5	±0.3	±1.5
5 mL blue Increment: 50 µL	100 µL	±0.6	±0.6	±0.6	±0.6
	1000 µL	±0.5	±5.0	±0.25	±2.5
10 mL orange Increment: 0.1 mL	200 µL 0.2 mL	±0.5	±1.0	±0.6	±1.2
	2 000 µL 2 mL	±0.5	±10	±0.25	±5.0
25 mL red Increment: 0.25 mL	500 µL 0.5 mL	±0.4	±2.0	±0.6	±3.0
	5000 µL 5 mL	±0.3	±15	±0.25	±12.5
50 mL light gray Increment: 0.5 mL	1000 µL 1 mL	±0.3	±3.0	±0.5	±5.0
	10000 µL 10 mL	±0.3	±30	±0.3	±30

9.4.3 Multipette stream / Multipette Xstream

Combitip advanced	Volume range	Testing volume	Error limits			
			Error			
			Systematic error		Random error	
			± %	± µL	± %	± µL
0.1 mL (white piston) Increment: 0.1 µL	1 µL – 100 µL	10 µL	±1.6	±0.16	±2.5	±0.25
		50 µL	±1.0	±0.5	±1.5	±0.75
		100 µL	±1.0	±1.0	±0.5	±0.5
0.2 mL (blue piston) Increment: 0.2 µL	2 µL – 200 µL	20 µL	±1.3	±0.26	±1.5	±0.3
		100 µL	±1.0	±1.0	±1.0	±1.0
		200 µL	±1.0	±2.0	±0.5	±1.0
0.5 mL Increment: 0.5 µL	5 µL – 500 µL	50 µL	±0.9	±0.45	±0.8	±0.4
		250 µL	±0.9	±2.25	±0.5	±1.25
		500 µL	±0.9	±4.5	±0.3	±1.5
1 mL Increment: 1 µL	10 µL – 1000 µL	100 µL	±0.9	±0.9	±0.55	±0.55
		500 µL	±0.6	±3.0	±0.3	±1.5
		1000 µL	±0.6	±6.0	±0.2	±2.0
2.5 mL Increment: 2.5 µL	25 µL – 2500 µL	250 µL	±0.8	±2.0	±0.45	±1.125
		1250 µL	±0.5	±6.25	±0.3	±3.75
		2500 µL	±0.5	±12.5	±0.15	±3.75
5 mL Increment: 5 µL	50 µL – 5000 µL	500 µL	±0.8	±4.0	±0.35	±1.75
		2500 µL	±0.5	±12.5	±0.25	±6.25
		5000 µL	±0.5	±25	±0.15	±7.5

Combitip advanced	Volume range	Testing volume	Error limits			
			Error			
			Systematic error		Random error	
			± %	± mL	± %	± mL
10 mL Increment: 10 µL	0.1 mL – 10 mL	1 mL	±0.5	±0.005	±0.25	±0.0025
		5 mL	±0.4	±0.02	±0.25	±0.0125
		10 mL	±0.4	±0.04	±0.15	±0.015

Combitip advanced	Volume range	Testing volume	Error limits			
			Error			
			Systematic error		Random error	
			± %	± mL	± %	± mL
25 mL (blue adapter) Increment: 25 µL	0.25 mL – 25 mL	2.5 mL	±0.3	±0.0075	±0.35	±0.0088
		12.5 mL	±0.3	±0.0375	±0.25	±0.0313
		25 mL	±0.3	±0.075	±0.15	±0.0375
50 mL (Dark gray adapter) Increment: 50 µL	0.5 mL – 50 mL	5 mL	±0.3	±0.015	±0.50	±0.025
		25 mL	±0.3	±0.075	±0.20	±0.05
		50 mL	±0.3	±0.15	±0.15	±0.075

9.5 Varispenser / Top Buret

The following specifications for Varispenser and Top Buret are valid for the following conditions:

Liquid:	Distilled or deionized water
Reference temperature:	20 °C to 25 °C, ±0.5 °C unchanging
Number of determinations:	10, in accordance with EN ISO 8655

9.5.1 Varispenser and Varispenser plus

Setting range	Tested volume	Systematic error (inaccuracy)	Random error (imprecision)
0.5 mL – 2.50 mL	2.5 mL	±0.6 %	≤ 0.1 %
1.00 mL – 5.00 mL	5.0 mL	±0.5 %	≤ 0.1 %
2.00 mL – 10.0 mL	10.0 mL	±0.5 %	≤ 0.1 %
5.00 mL – 25.0 mL	25.0 mL	±0.5 %	≤ 0.1 %
10.0 mL – 50.0 mL	50.0 mL	±0.5 %	≤ 0.1 %
20.0 mL – 100.0 mL	100.0 mL	±0.5 %	≤ 0.1 %

9.5.2 Top Buret

Size	Setting range	Systematic error (inaccuracy)	Random error (imprecision)
C	25 mL	±0.2 %	≤ 0.1 %
H	50 mL	±0.2 %	≤ 0.1 %

9.6 Error limits in accordance with EN ISO 8655

The error limits always refer to the overall system: pipette and tip. If the nominal volume of the pipette lies between two entries in the table, the absolute error values for the next largest nominal volume apply.

The absolute error limits in μL referring to the nominal volume apply to each volume which can be set on the piston stroke pipette. The list below includes the absolute and relative error limits in relation to the volume.

9.6.1 Air-cushion pipettes, fixed and adjustable volume

Nominal volume	Error limits			
	Measurement errors			
	Systematic		Random	
	\pm %	\pm μL	\pm %	\pm μL
1 μL	± 5.0	± 0.05	± 5.0	± 0.05
2 μL	± 4.0	± 0.08	± 2.0	± 0.04
5 μL	± 2.5	$\pm 0,125$	± 1.5	± 0.075
10 μL	± 1.2	$\pm 0,12$	± 0.8	± 0.08
20 μL	± 1.0	± 0.2	± 0.5	± 0.1
50 μL	± 1.0	± 0.5	± 0.4	± 0.2
100 μL	± 0.8	± 0.8	± 0.3	± 0.3
200 μL	± 0.8	$\pm 1,6$	± 0.3	± 0.6
500 μL	± 0.8	± 4.0	± 0.3	± 1.5
1000 μL	± 0.8	± 8.0	± 0.3	± 3.0
2000 μL	± 0.8	± 16.0	± 0.3	± 6.0
5000 μL	± 0.8	± 40.0	± 0.3	± 15.0
10000 μL	± 0.6	± 60.0	± 0.3	± 30.0



For Multi-channel pipettes, the error values are two times the values specified for single-channel pipettes.

9.6.2 Positive displacement pipettes (Biomaster)

Nominal volume	Error limits			
	Measurement errors			
	Systematic		Random	
	± %	± µL	± %	± µL
5µL	±2.5	±0,13	±1.5	±0.08
10µL	±2.0	±0.2	±1.0	±0.1
20µL	±2.0	±0.4	± 0.8	±0,16
50µL	±1.4	±0,7	±0.6	±0.3
100µL	±1.5	±1.5	±0.6	±0.6
200 µL	±1.5	±3.0	±0.4	±0.8
500µL	±1.2	±6.0	±0.4	±2.0
1000 µL	±1.2	±12.0	±0.4	±4.0

9.6.3 Dispenser (Multipette)

Nominal volume	Error limits			
	Measurement errors			
	Systematic		Random	
	± %	± µL	± %	± µL
0.001 mL	±5.0	±0.05	±5.0	±0.05
0.002 mL	±5.0	±0.1	±5.0	±0.1
0.003 mL	±2.5	±0.075	±3.5	±0,11
0.01 mL	±2.0	±0.2	±2.5	±0.25
0.02 mL	±1.5	±0.3	±2.0	±0.4
0.05 mL	±1.0	±0.5	±1.5	±0.75
0,1 mL	±1.0	±1.0	±1.0	±1.0
0.2 mL	±1.0	±2.0	±1.0	±2.0
0.5 mL	±1.0	±5.0	±0.6	±3.0
1 mL	±1.0	±10.0	±0.4	±4.0
2 mL	± 0.8	±16.0	±0.4	±8.0
5 mL	±0.6	±30.0	±0.3	±15.0
10 mL	±0.5	±50.0	±0.3	±30.0
25 mL	±0.5	±125.0	±0.3	±75.0
50 mL	±0.5	±250	±0.25	±125.0
100 mL	±0.5	±500	±0.25	±250.0
200 mL	±0.5	±1000	±0.25	±500.0

9.6.4 Single-stroke dispenser (Varispenser)

Nominal volume	Error limits			
	Measurement errors			
	Systematic		Random	
	± %	± µL	± %	± µL
0.01 mL	±2.0	±0.2	±1.0	±0.1
0.02 mL	±2.0	±0.4	±0.5	±0.1
0.05 mL	±1.5	±0.75	±0.4	±0.2
0.1 mL	±1.5	±1.5	±0.3	±0.3
0.2 mL	±1.0	±2.0	±0.3	±0.6
0.5 mL	±1.0	±5.0	±0.2	±1.0
1 mL	±0.6	±6.0	±0.2	±2.0
2 mL	±0.6	±12.0	±0.2	±4.0
5 mL	±0.6	±30.0	±0.2	±10.0
10 mL	±0.6	±60.0	±0.2	±20.0
25 mL	±0.6	±150.0	±0.2	±50.0
50 mL	±0.6	±300.0	±0.2	±100.0
100 mL	±0.6	±600.0	±0.2	±200.0
200 mL	±0.6	±1200	±0.2	±400.0

9.6.5 Piston stroke burets

Nominal volume	Error limits			
	Measurement errors			
	Systematic		Random	
	± %	± µL	± %	± µL
1 mL	±0.6	±6.0	±0.1	±1.0
2 mL	±0.5	±10.0	±0.1	±2.0
5 mL	±0.3	±15.0	±0.1	±5.0
10 mL	±0.3	±30.0	±0.1	±10.0
20 mL	±0.2	±40.0	±0.1	±20.0
25 mL	±0.2	±50.0	±0.1	±25.0
50 mL	±0.2	±100.0	±0.1	±50.0
100 mL	±0.2	±200	±0.1	±100.0

Index

A

Accuracy 6
 Adjustable-volume pipettes
 Adjust 16
 Adjusting adjustable volume pipettes
 Technical specifications 37
 Adjustment 15
 Fixed-volume pipettes 30
 General information 15

B

Balance
 Type 6
 Balances 6
 Accuracy 6
 minimum requirements 6

C

Calibration software 7
 Cleaning 12
 Climatic conditions 7

D

Dispensing the
 test volume 9, 9

E

Error causes 14
 Error correction 14
 Error limits 53
 Evaporation 7

F

Factor Z
 Table 33
 Fixed-volume pipettes
 Adjust 30

Technical specifications 34

J

Justierung
 Adjustable-volume pipettes 15

L

Leakage check 13

M

Measurement
 Work method 9
 Measuring station 7
 Multi-channel pipettes
 Technical specifications 45
 Multipipette
 Technical specifications 48

P

Physical influences of liquids 32
 Pipette conditions 6

R

Random error 10

S

Scope of testing
 Adjusting adjustable volume pipettes .8
 Bottle-top dispenser, Top Buret 8
 Multi-channel pipettes 8
 Multipipette 8
 Sterilization 11
 Systematic error 10

T

Technical specifications
 Adjusting adjustable volume pipettes 37
 Conditions 34
 Fixed-volume pipettes 34

Multi-channel pipettes	45
Multipette	48
Top Buret.....	52
Varispenser.....	52
Temperature differences	7
Test conditions	6
Test liquid	7
Test room.....	7
Top Buret	
Technical specifications	52
V	
Varispenser	
Technical specifications	52
Volume errors.....	15
W	
Work method	9

Evaluate your manual

Give us your feedback.

www.eppendorf.com/manualfeedback

Your local distributor: www.eppendorf.com/contact

Eppendorf AG · 22331 Hamburg · Germany

eppendorf@eppendorf.com · www.eppendorf.com