

EzScope 101 Live Cell Imaging System

BRLC-0101

Operation Manual

Ver. 1.1



Copyright © 2019 Blue-Ray Biotech Corp.
All Rights Reserved.

Table of Contents

1. Safety Precautions	1
1.1 Intended Use.....	1
1.2 General Instrument Safety	1
1.3 Chemical Safety	2
1.4 Chemical Waste Safety	3
1.5 Electrical Safety	3
1.6 Safety Symbols	3
2. General Description	4
2.1 Features	4
2.2 Product Overview.....	5
3. Getting Started	7
3.1 Unpacking.....	7
3.2 Initial Setup.....	7
4. Using EzCapture Software	10
4.1 Live View Mode	10
4.2 Image View Mode	12
4.3 Analysis	14
4.4 System Setting	19
5 Remote Monitoring	23
6 Maintenance	24
6.1 Cleaning the Unit.....	24
6.2 Cleaning the LED Lamp Arm	24
6.3 Cleaning the Lens	24
7 Troubleshooting	25
7.1 Warning Messages.....	26
7.2 Error Messages	26
Appendix A: Technical Specifications	27
Appendix B: CE Declaration	28
Appendix C: Order Information	29

1. Safety Precautions

Before using the **EzScope 101** for the first time, please read this entire Operation Manual carefully. To guarantee problem free, safe operation of the **EzScope 101**, it is essential to observe the following section.

1.1 Intended Use

This instrument is intended to be used by trained personnel to perform live-cell imaging. In this Manual we assume the user to have knowledge of basic laboratory procedures and cell cultures.

1.2 General Instrument Safety

 **PHYSICAL INJURY HAZARD.** Using the instrument in a manner not specified by Blue-Ray Biotech may result in personal injury or damage to the instrument.

1.2.1 Transportation and Storage

This **instrument** should be transported and stored in an environment with a temperature of -20 - 60 °C, relative humidity 20 - 80%.

1.2.2 Installation and Operation

1. Do not use the device in a potentially explosive environment or with potentially explosive chemicals.
2. Avoid placing the device in direct sunlight.
3. Install the device inside a functional incubation chamber with a temperature of 4 - 42 °C, relative humidity $\leq 95\%$ (non-condensing).
4. Choose a flat, stable surface capable of bearing the weight of the device.
5. Make sure the power source conforms to the required power supply specifications.
6. To avoid electric shock, make sure the device is plugged into a grounded electrical outlet.
7. Do not allow water or any foreign objects to enter the various openings of the device.
8. The device should only be operated indoors.
9. The maximum operating altitude of the device: 3,000 meters.

1.2.3 Cleaning, Decontaminating, and Servicing the Instrument

Before using a cleaning or decontamination method other than those recommended by the manufacturer, verify with the manufacturer that the proposed method will not damage the equipment.

Switch off and unplug the device before cleaning, servicing, or replacing the fuses.

Repairs should be carried out by authorized service personnel only.

1.2.4 Instructions for Removal From Use, Transportation, or Disposal

Do not dispose of this product as unsorted municipal waste. Follow local municipal waste ordinances for proper disposal provisions to reduce the environmental impact of waste electrical and electronic equipment (WEEE).

European Union Customers:

Call your local Blue-Ray Biotech Distributor's Customer Service office for equipment pick-up and recycling.

1.3 Chemical Safety

1.3.1 Chemical Hazard Warning

 **CHEMICAL HAZARD.** Before handling any chemicals, refer to the Material Safety Data Sheet (MSDS) provided by the manufacturer, and observe all relevant precautions.

1.3.2 About MSDSs

Chemical manufacturers supply current Material Safety Data Sheets (MSDSs) with shipments of hazardous chemicals to new customers. They also provide MSDSs with the first shipment of a hazardous chemical to a customer after an MSDS has been updated. MSDSs provide the safety information you need to store, handle, transport, and dispose of the chemicals safely.

Each time you receive a new MSDS packaged with a hazardous chemical, be sure to replace the appropriate MSDS in your files.

1.3.3 Chemical Safety Guidelines

To minimize the hazards of chemicals:

- Read and understand the Material Safety Data Sheets (MSDSs) provided by the chemical manufacturer before you store, handle, or work with any chemicals or hazardous materials. (See ***“About MSDSs” in Section 1.3.2***)
- Minimize contact with chemicals. Wear appropriate personal protective equipment when handling chemicals (for example, safety glasses, gloves, or protective clothing). For additional safety guidelines, consult the MSDS.
- Minimize the inhalation of chemicals. Do not leave chemical containers open. Use only with adequate ventilation (for example, fume hood). For additional safety guidelines, consult the MSDS.
- Check regularly for chemical leaks or spills. If a leak or spill occurs, follow the manufacturer's cleanup procedures as recommended in the MSDS.
- Comply with all local, state/provincial, or national laws and regulations related to chemical storage, handling, and disposal.

1.4 Chemical Waste Safety

1.4.1 Chemical Waste Hazard

 **HAZARDOUS WASTE.** Refer to Material Safety Data Sheets and local regulations for handling and disposal.

1.5 Electrical Safety







 **ELECTRICAL SHOCK HAZARD.** Severe electrical shock can result from operating the **EzScope 101** without its instrument housings in place. Do not remove instrument housings. High-voltage contacts are exposed when instrument housings are removed from the instrument.

1.5.1 Power

 **ELECTRICAL HAZARD.** Grounding circuit continuity is vital for the safe operation of equipment. Never operate equipment with the grounding conductor disconnected. Use properly configured and approved line cords for the voltage supply in your facility. Plug the system into a properly grounded receptacle with adequate current capacity.

1.6 Safety Symbols

Explanations of symbols related to safety which are used on the equipment.

	Temperature limit		Protective conductor terminal
	Humidity limitation		Caution-Risk of danger
	Atmospheric pressure limitation		In vitro diagnostic medical device
	Waste Electrical and Electronic Equipment (WEEE) recycling instructions		

2. General Description

The **EzScope 101** is a compact, specialized inverted brightfield microscope that is designed to be operated inside the incubation chamber for live cell observation and documentation. It is equipped with a white LED light and exchangeable objective lenses that enable the user to monitor and record the live cell status in the incubator.

2.1 Features

- White LED illumination.
- 10x/20x exchangeable objective lens.
- Motorized focusing.
- 1.3 MP high quality camera.
- Up to 4-unit daisy chain connection.
- Robust and modern outlook design.
- Simple and user-friendly graphical interface.
- Captures single image or multiple images via time-lapse methods.
- Image editing, annotation, measuring, and analysis.
- Converts the time-lapse image series to a video clip.

2.2 Product Overview

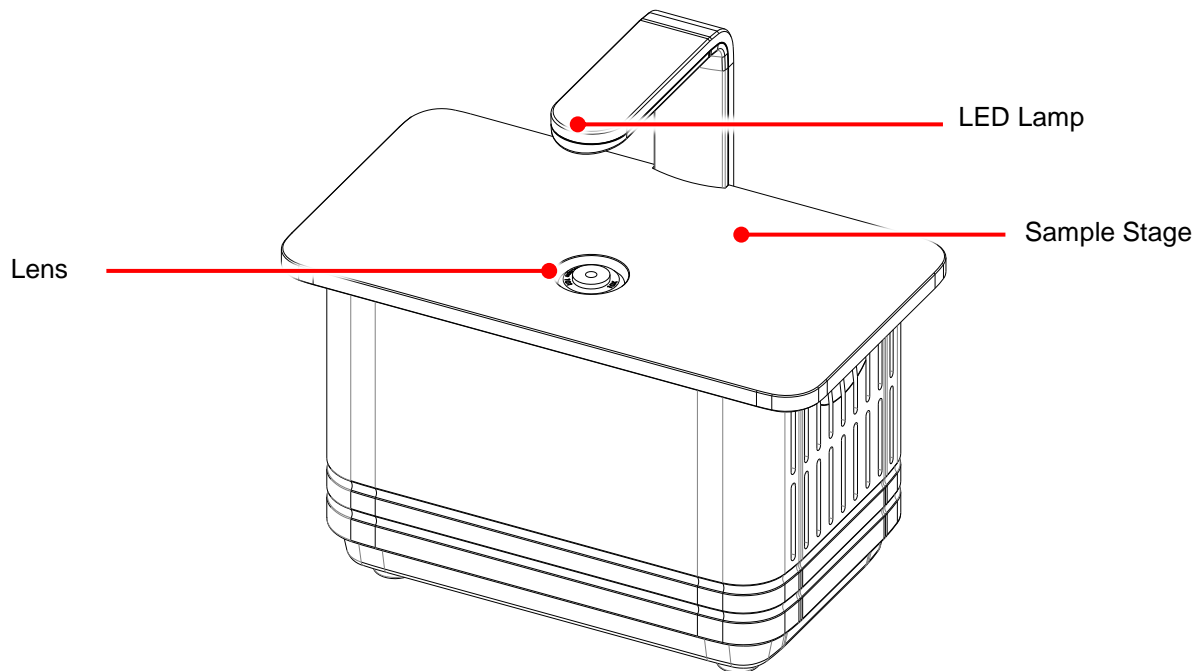

Figure 1. Front View

Name	Function
Lens	Exchangeable objective lens for image acquisition.
LED Lamp	Light source for imaging.
Sample Stage	Can accommodate most commonly used cell culture vessels.

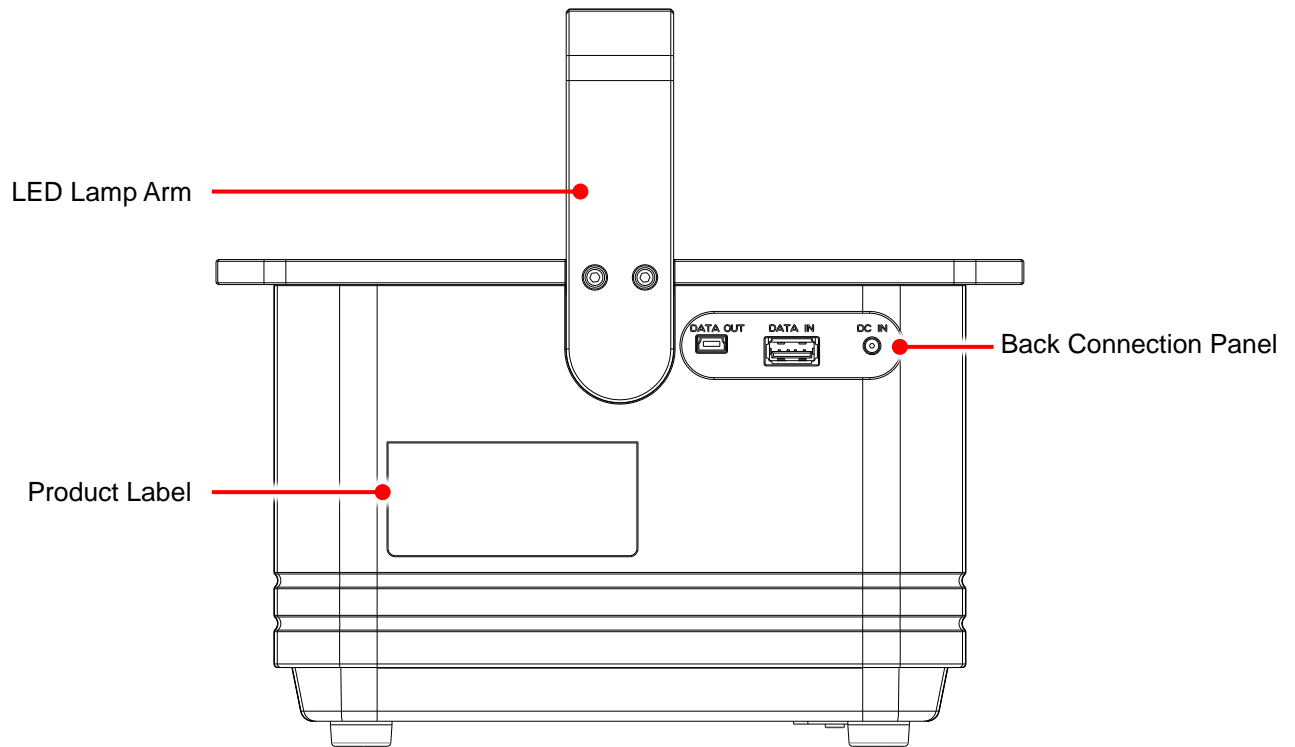

Figure 2. Rear View

Name	Function
LED Lamp Arm	With Light source for imaging.
Product Label	Indicates the model name, serial number, power specification, and other important information.
Back Connection Panel	For cable connection.

3. Getting Started

3.1 Unpacking

Open the **EzScope 101** package and confirm that all items below are included:

- **EzScope 101** Unit x 1 with 10x Objective Lens
- Quick Guide x 1
- Warranty Card x 1
- USB Flash Drive x 1 (Containing EzCapture Software and Operation Manual)
- LED Lamp Arm x 1 (with 2 Fixation Screws and Hex Wrench x 1)
- DC 5V Power Adaptor x 1
- USB Data Cable x 1

If there are any items missing, damaged, or any incorrect items in the package, please contact your local Blue-Ray Biotech's distributor or sales representative immediately.

3.2 Initial Setup

3.2.1 LED Lamp Arm Installation

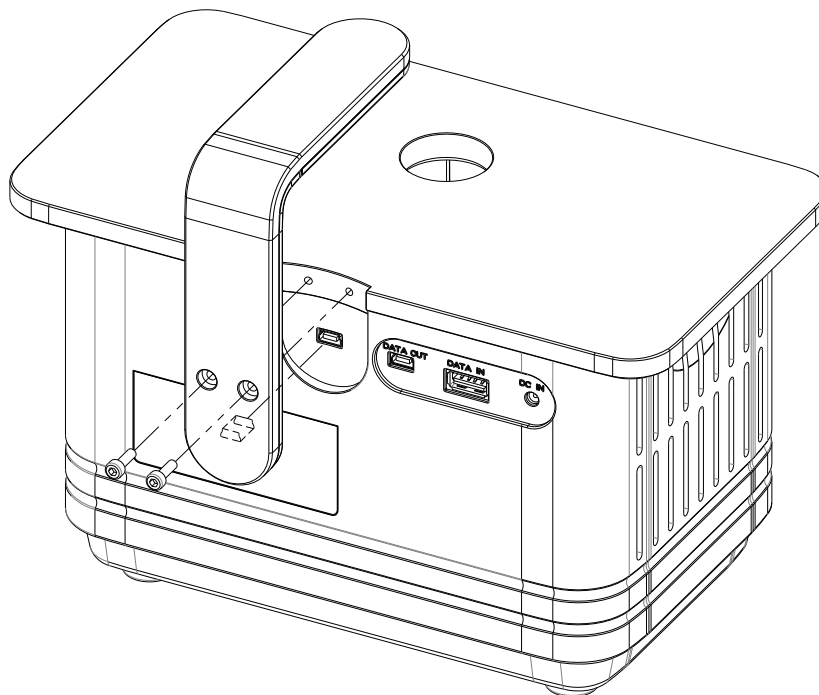

Figure 3. Installation of the LED Lamp Arm

Plug the mini USB of the LED Lamp Arm into the mini USB port of the EzScope. Tighten 2 screws with the hex wrench.

3.2.2 Cable Connection

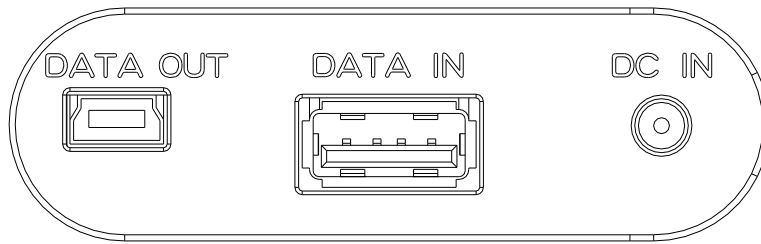

Figure 4. Back Connection Panel

Name	Function
Data Out Port	For data output to your control PC.
Data In Port	For daisy chain connection of another EzScope 101 unit.
DC In Port	For power adaptor connection.

For multiple-device cable connection, please refer below figure 5.

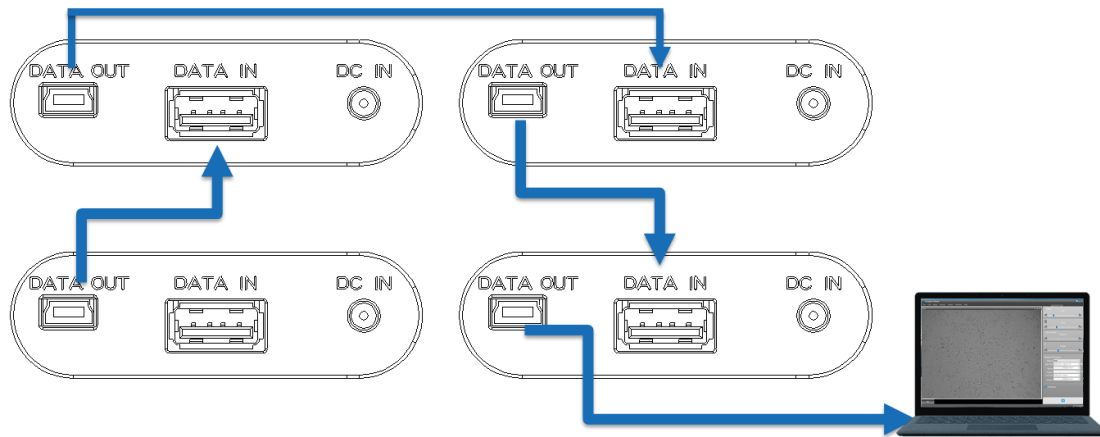

Figure 5. Multiple-Devices Cable Connection

3.2.3 EzCapture Software Installation

PC Requirement: i3 CPU with 4 GB RAM, Windows 10 OS. i5 CPU with 8GB RAM for multiple unit connection.

To install EzCapture, run the setup.exe in the EzCapture folder. Follow the on-screen instructions to finish the installation.

To launch the EzCapture software, select EzCapture from the Windows start menu or double click on the EzCapture Icon on the Desktop

3.2.4 Setting up the System

Before placing the EzScope 101 inside the incubator, remove the lens cap and clean the device with a lint free cloth or Kimwipe™ soaked with 70% ethanol alcohol.

Note

Do not use acetone to clean the device or autoclave the device.

- **Cable Placement**

Your incubator may have a cable port in the back.

If so, please guide the USB cable and the power cable through it (Figure 6a below).

If no cable port is present, place the cables between the glass inner door and the gasket of the incubator (Figure 6b below). Keep the cables free from the hinges to prevent damage to the cables.

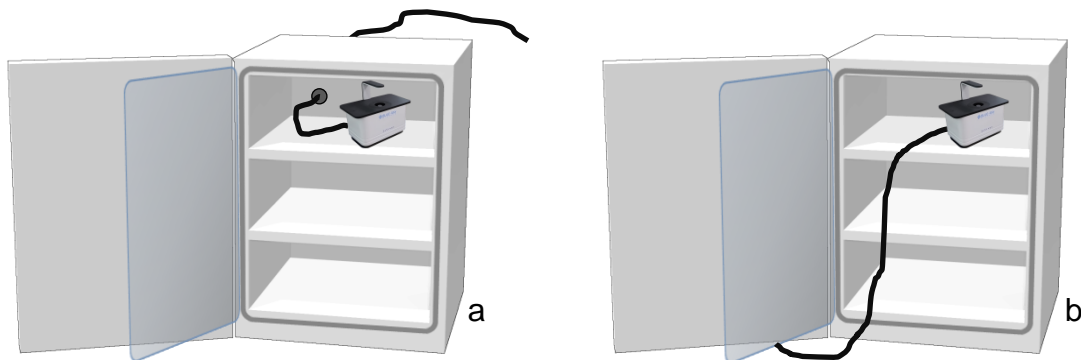

Figure 6. Cable Placement

- **Temperature Equilibrium**

Note

DO NOT plug the power adaptor to the power outlet at this stage.

Due to the temperature difference between the device and the environment inside the incubator, condensation may occur on the device. To prevent damage to the device, please allow the device to be set inside the incubator for more than 1 hour before you plug the power adaptor into power outlet. This may also help to reduce temperature fluctuation to your cells when you put your culture vessel on the stage of the device.

3.2.5 Vessel Placement

Please place the EzScope 101 in the incubator with the logo facing the operator. By doing this, the displayed image moves in the same direction when the vessel is moved on the EzScope 101's stage.

4. Using EzCapture Software

Double click on the EzCapture icon on the desktop (or other chosen location) of PC or laptop to open the EzCapture software. There are two modes in EzCapture, **Live View Mode** and **Image View Mode**.

When one EzScope unit is connected to the computer, **Live View Mode** will be displayed. If the EzScope unit is not connected to the computer, **Image View Mode** will be displayed when you open the EzCapture software.

4.1 Live View Mode

EzCapture software will search for any connected EzScope units and display a Live View Image of connected units.

Click on the connected unit's tab, and the live view mode will be displayed (Figure 7).

- **Status**

It shows the connection status between the EzScope and the computer.

- **Connected Unit**

On the connected unit bar, it shows all connected EzScope devices or opened images. To monitor or control any EzScope devices, you can click a device name shown on the connected unit bar. The live view image of the device will show in the **Live View Window**.

- **Live View Window**

Place a culture vessel on the EzScope's sample stage to begin. A live view image of the cells will be visible in the Live View Window (Figure 7). To obtain the best quality of the image, you can adjust image tools shown on the **Control Panel**.

To save energy, the **Live View Window** will automatically shut down after the EzScope 101 is connected to the computer for 15 minutes. 30 seconds before the closing of **Live View Window**, a window will pop up asking if you want to continue staying in the **Live View Window**.

To restart **Live View Window** again, click on the connected unit's tab.

- **Control Panel**

On the Control Panel, tools described below are provided to adjust your image.

- **LED**

For illumination intensity setting, click the left or right adjustment button .

- **Focus**

For coarse focusing, move the sliding bar directly.

For fine focusing, click or hold on the left or right adjustment button .

The home icon  can be used to bring the lens to the lowest home position.

The window above the right adjustment button shows the current focus value.

EzCapture will reproduce the same focus position by entering the same value in the future.

➤ **Exposure**

Check the **Auto** box to enable auto exposure. The optimum exposure time is displayed next to the **Auto** box. You can uncheck the **Auto** box to disable the auto exposure and adjust the exposure time by moving the sliding bar or clicking on the left or right adjustment button .

➤ **Display**

The Display function provides digital zoom in/out when you need to check the details of an image or view the whole image.

The digital zoom level of the displayed live view image can be adjusted by moving the sliding bar or clicking on the left or right adjustment button .

➤ **Time-lapse Photography**

You can configure your time-lapse sequence capturing parameter here. Please refer to **Section 4.3.1** for further information.

➤ **Timestamp**

Check to enable the timestamp on the live view image and on the captured images.

➤ **Flat-Field Correction**

For better image quality, check the Flat-Field Correction button to enable the function. This function provides background correction based on saved settings. Please refer to **Section 4.4.1** for further information.

➤ **Image Capture Button**

Click  to start your single image capturing.

If you are capturing a time-lapse sequence, the capturing progress will be displayed on the button. You can stop the time-lapse sequence capturing by clicking the button again.

Note

The default image storage directory is C:\Users\your name\Documents\EzCapture.

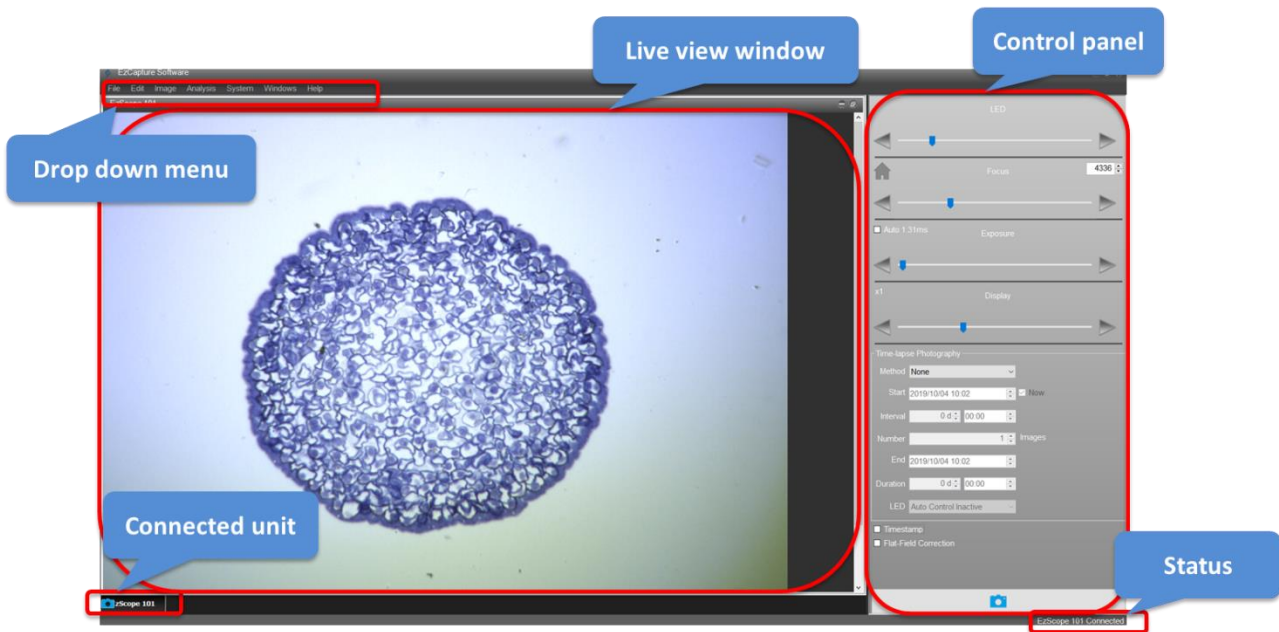

Figure 7. Live View Mode

4.2 Image View Mode

When you capture/open an image from the EzCapture software, the **Image View Mode** will be displayed. You can edit and analyze your image in this mode (Figure 8).

- **Opened/Captured Image**

It shows all your opened/captured images.





You can choose an opened/captured image to be shown in the Image Window.



- **Image Window**

It shows the image you have opened (captured).

- **Editing Panel**

- **Drawing Tool**

Name	Function
Text 	The text tool allows you to type text anywhere on the image.
Line 	The line tool allows you to draw lines on the image.
Arrow 	The arrow tool allows you to draw arrows on the image.
Rectangle 	The rectangle tool allows you to draw rectangles on the image.
Ellipse 	The ellipse tool allows you to draw ellipses on the image.



Freehand 	The freehand tool allows you to draw a line freely on the image.
Undo/Redo 	The tool allows you to undo or redo your editing actions. Please note that undo actions will be cleared after you save the image file.

➤ **Time-lapse Series Bar**

If you capture the image under the Time-lapse setting, the Time-lapse Series tool will be enabled.

The number on the top right of the Time-lapse Series bar is the total number of captured images.

The number on the top left of the Time-lapse Series bar is the image showing in the Image Window.

To show a certain image, you can move the sliding bar or click on the left or right adjustment button  . You can also fill in a number in the top left and press the “Enter” key to show the desired image.

➤ **Zoom**

This tool provides digital zoom in/out for the image.

➤ **Brightness**

This tool provides Brightness adjustment.

➤ **Contrast**

This tool provides Contrast adjustment.

➤ **Color**

This tool provides Color adjustment.

➤ **White Balance**

This tool allows you to adjust the color temperature of the image.

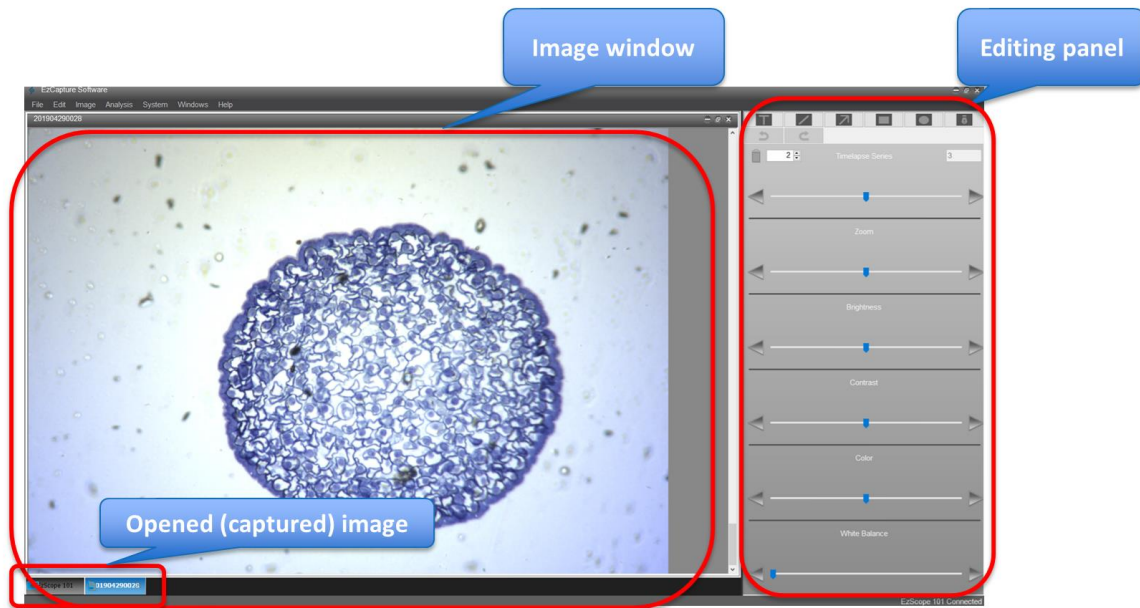

Figure 8. Image View Mode

4.3 Analysis

4.3.1 Time-lapse Photography

You can configure your time-lapse sequence capturing parameters here. EzCapture provides methods to allow you to set time-lapse image acquisition based on your experimental conditions. The maximum capacity of each time-lapse file is 1,000 images.

- **Method:**
 Select **None** to capture a single image. This also disables all the other settings.
 Select **Image** to set the total image number for your time-lapse sequence.
 Select **Duration** to set the duration time for your time-lapse sequence capturing event.
- **Start Date:**
 Set the starting date and time for your time-lapse capturing. Check the **Now** box to start your capturing immediately after you click on the image capture button.
- **Interval:**
 Set the time interval between each image capturing in your time-lapse sequence. The format of the time is HOUR: MINUTE.
- **Number:**
 If you select the **Image** method, you can set the total image number for your time-lapse sequence. The setting range is **1-1,000** images.
 This setting option will be blocked when you select the **Duration** method, the total image number will be calculated by the software automatically.

- **End Date:**

The end date/time will be calculated by the software automatically according to your settings.

- **Duration:**

If you select **Duration** method, you can set the duration time for your time-lapse sequence.

This setting option will be blocked when you select **Image** method, the duration will be calculated by the software automatically.

- **LED:**

The illumination setting during Time-lapse capturing.

Auto Control Active: LED lamp will be turned on only when capturing image.

Auto Control Inactive: LED lamp will always be turned on during Time-lapse capturing (Figure 9).

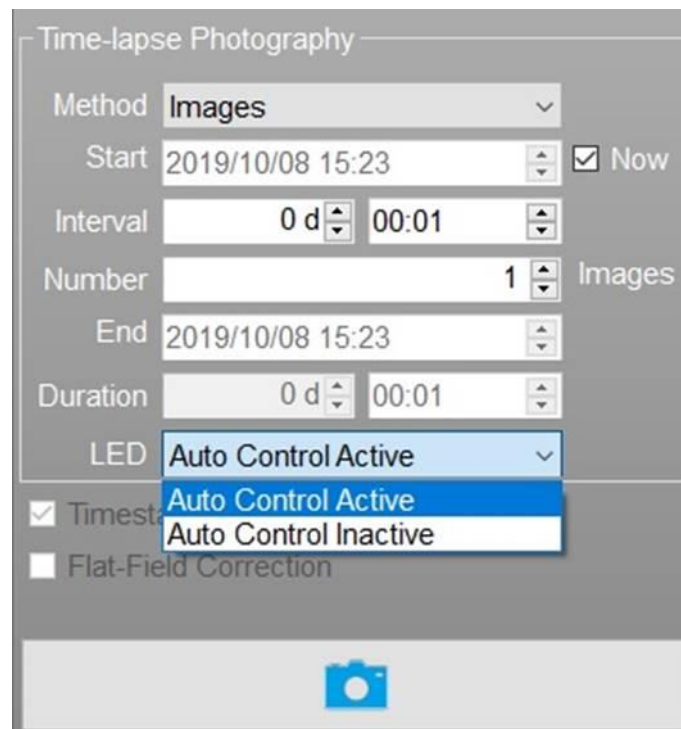

Figure 9. Time-lapse Photography Setting Window

Note

Parameters will be locked during time-lapse capturing.

To unlock the parameter setting function during time-lapse photographing, move the mouse on Capturing icon (Figure 10) and press "Ctrl + Alt + L" to unlock the parameter setting function.

After adjusting the parameters, press "Ctrl + Alt + L" to lock the parameter setting functions to avoid accidental touch of parameters.

During time-lapse photography, the camera will automatically turn off. To view live image, use “Ctrl + Alt + L” to activate the camera and observe the live image, or adjust the parameters. If it is not relocked, the system will automatically turn off the camera after 3 minutes. To extend the shutdown time, please refer to section 4.4.1.

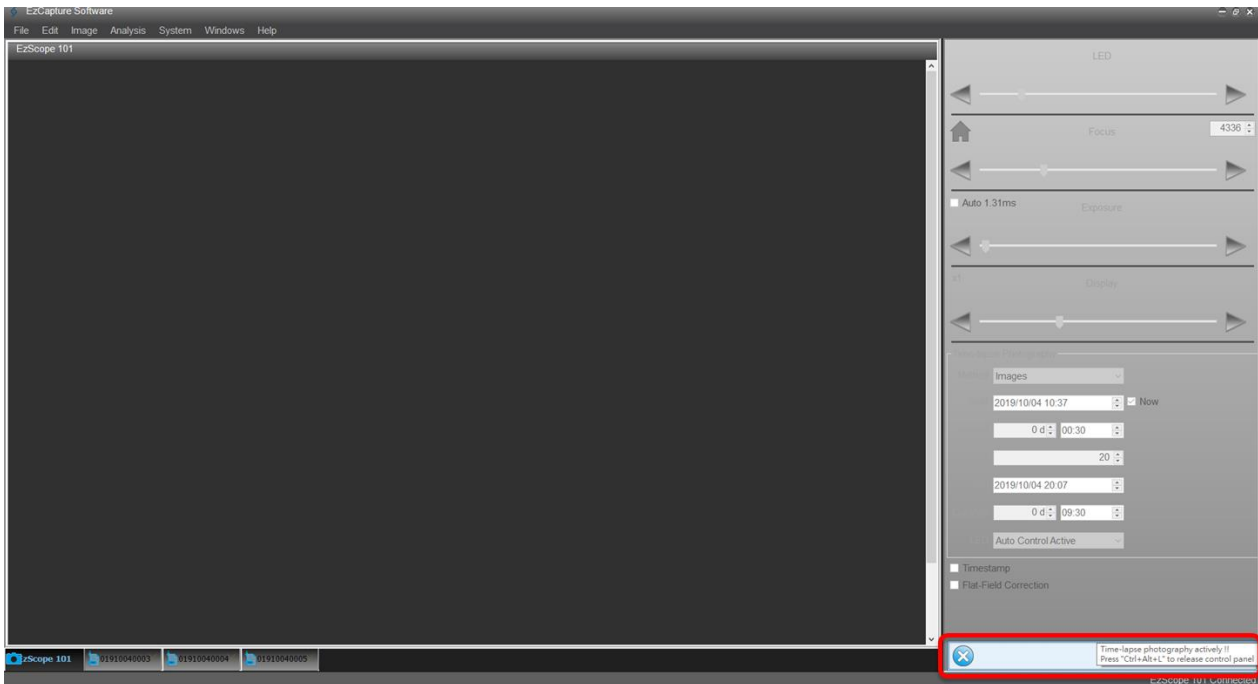

Figure 10. Unlock parameter setting functions and view live image during Time-lapse Photography

4.3.2 Measurement

In **Image View Mode**, you can select **Analysis Menu>Measurement** in the tool bar (Figure 11). The tools for **Measurement** will be shown on the Control Panel (Figure 12).

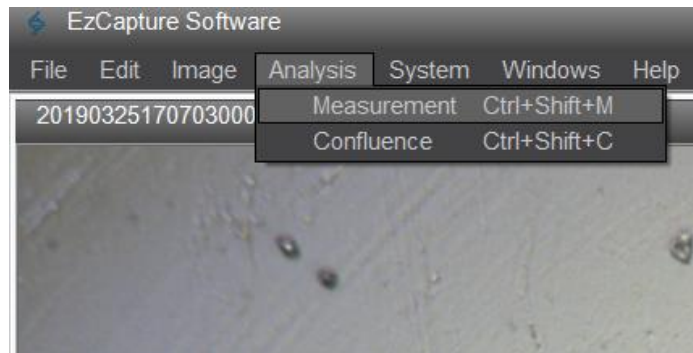

Figure 11. Analysis Tool Bar

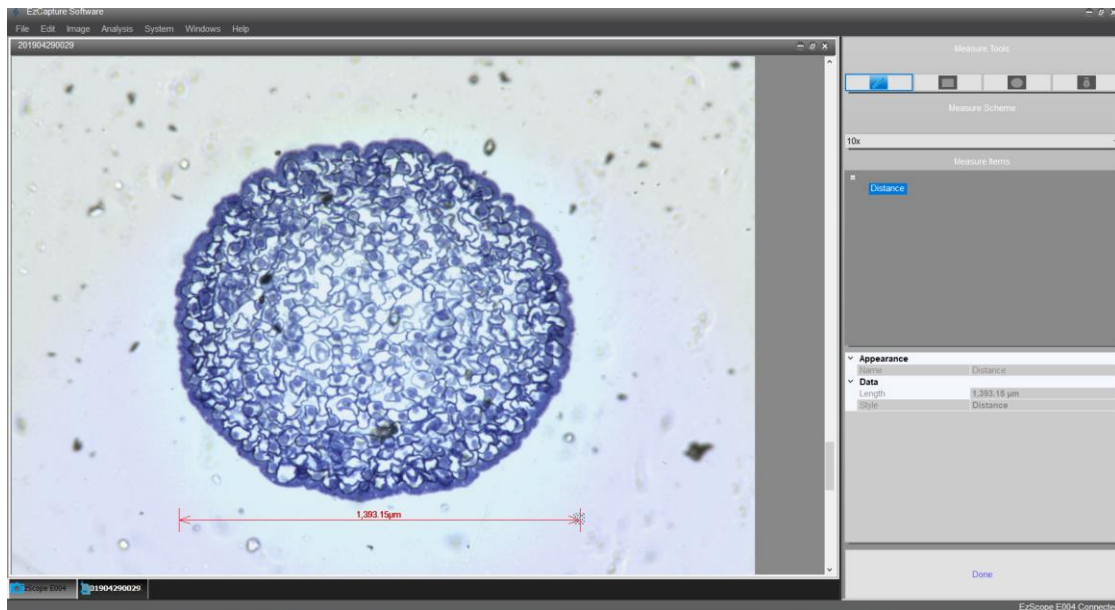

Figure 12. Measurement Tools

- **Measurement Tool**

This tool provides you to measure distance and area on the captured image.

- **Line Measurement** 

Select the icon to draw a linear line to measure linear distance on the captured image.

- **Rectangle Measurement** 

Select the icon to draw a rectangle to measure area on the captured image.

- **Ellipse Measurement** 

Select the icon to draw an ellipse to measure area on the captured image.

- **Freehand Measurement** 

Select the icon to draw a line freely to measure distance of the line on the captured image.

- **Measurement Scheme**

Select the spatial calibration for the measurement.

- **Measurement Items**

The events of measurement will list in this area. When you select one of the events, the details of the measurement will be shown below.

When all the measurement settings are completed, click **“Done”** to finish editing.

4.3.3 Confluence

In **Image View Mode**, you can select **Analysis Menu>Confluence** in the tool bar. The tools for **Confluence** will be shown on the Control Panel (Figure 13).

- **Confluence Tools**

These tools allow you to select a certain area for measuring confluence. You can use one of them to select an area you want to measure on the image. If you make no selection, the whole image area can be measured for confluence.

- **Rectangle** 

Select the icon to draw a rectangle to measure confluence of the area on the captured image.

- **Ellipse** 

Select the icon to draw an ellipse to measure confluence of the area on the captured image.

- **Freehand** 



Select the icon to draw a freehand area to measure confluence of the area on the captured image.

- **Time-lapse Series**

If you capture the image under the Time-lapse setting, the Time-lapse Series tool will be enabled.

The number on the top right is the total number of captured images.

The number on the top left is the image showing in the Image Window.

To show a certain image, you can move the sliding bar or click on the left or right adjustment button  . You can also fill in a number in the top left and press the “Enter” key to show the desired image.

To delete a certain image, you can press  to delete the image.

- **Measurement Scheme**

Select the spatial calibration for the measurement.

- **Flat-Field Correction**



Correct an uneven background.

- **Confluence Areas**

If you use **Confluence Tools** to select a certain area for confluence analysis, areas will be shown at **Confluence Areas**.

When you select one of the areas, the details of the confluence analysis will show below.

- **Threshold**

Set the threshold setting for confluence. You can move the sliding bar or click on the left or right adjustment button  .

- **Opacity**

To adjust background opacity of the image, you can move the sliding bar or click on the left or right adjustment button ◀▶.

If all settings are completed, press **“Done”** to complete the Confluence analysis.

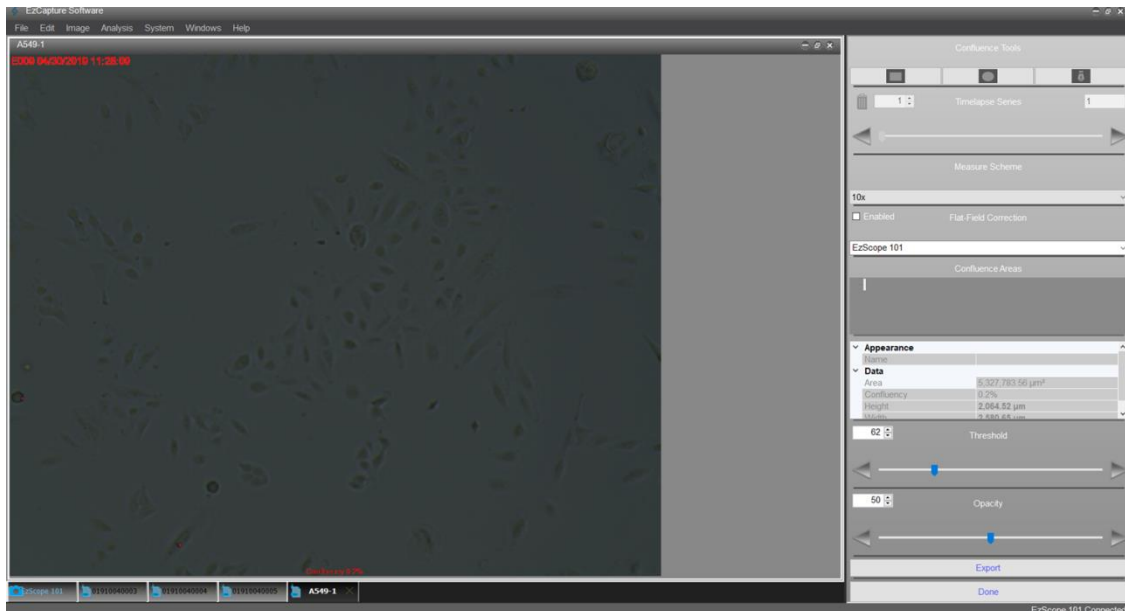

Figure 13. Confluence Analysis

The result can be exported as a PDF file containing the confluence values for all the photos in time-lapse photography. The data can be copied and pasted to other software for further analysis.

4.4 System Setting

The System Menu allows you to review and change settings of EzScope. Press **System** on the Tool bar. All System settings are available under **Live View Mode**.

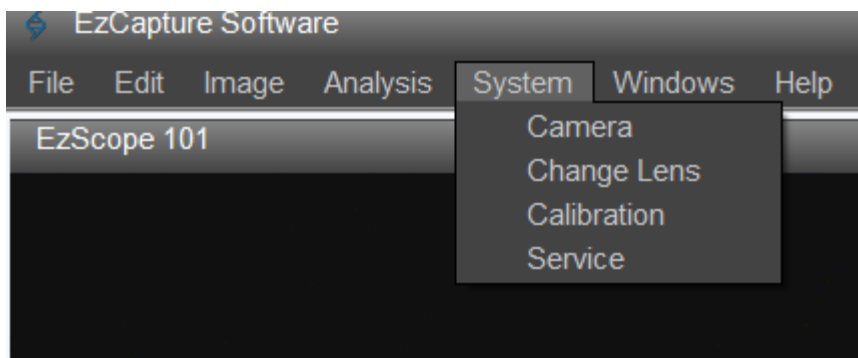

Figure 14. System Tool Bar

4.4.1 Camera



Figure 15. Camera Setting Panel

Select **Camera** and the setting panel will be shown (figure 15).

You can select an EzScope device using the drop-down box when you are connected to multiple EzScope devices (one computer can connect to up to four devices). The selected device information will show on the panel.

Name: You can edit name of your EzScope device by typing in the box.

Path: Check the box to change save the path for images. If you uncheck the **Path** box, images will save at the default path.

Default: It shows the default save path for images.

Sleep: During time-lapse photography, the camera will automatically turn off. To view live images, use Ctrl + Alt + L to evoke the camera and observe the live image, or change the parameter. If it is not relocked, the system will automatically turn off the camera after 3 minutes. The time to turn off the camera can be set here, up to 15 minutes.

- **Brightness Reference**

Set the brightness reference value for auto exposure detection.

- **Pixel Clock**

Set the image refresh rate.

- **Flat-Field Correction**

Flat-field correction is an important technique used to remove variations from images due to an uneven light source. The Flat-Field Correction function is used to capture background images as a uniformity reference. The captured uniformity reference can be applied to future captured images to eliminate the background variations.

1. Place your vessel on the **Sample Stage**. In the **Live View Mode**, adjust **Focus** and **Exposure** of the image.
2. Uncheck **Auto** box of the **Exposure** to disable the function.
3. Remove the vessels on the **Sample Stage**.
4. Click on the **Flat-Field Correction** button and a dialog box will appear (figure 16).
5. Enter the frame number you want to capture.
6. Click on the “**Capture**” button, EzScope will capture the images.
7. Click on the “**Apply**” button to apply captured images.
8. Click on the “**Done**” button to complete the correction.

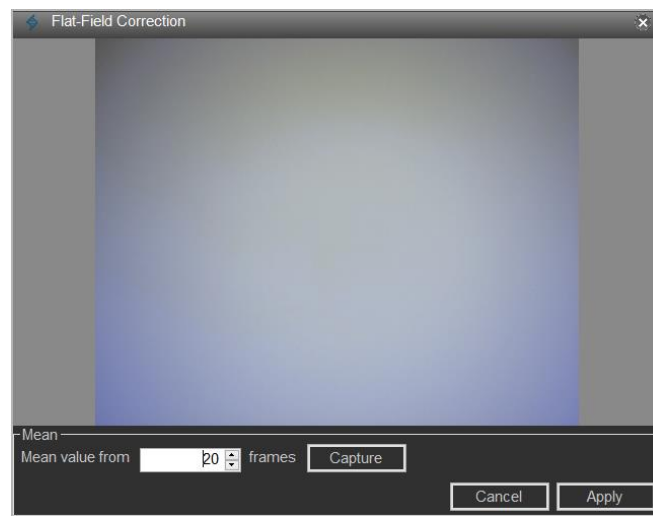

Figure 16. Flat-Field Correction Dialog Box

Note

REMOVE vessels on the Sample Stage BEFORE operate Flat-field correction

4.4.2 Changing Lens

REMOVE vessels or any objects on the sample stage BEFORE changing the objective lens.

EzScope has 10x and 20x objective lens that can be exchanged.

1. To change the objective lens, select **Change Lens**. The setting panel will be shown.
2. Select a device you want to change the objective lens for from the drop-down box, and click the “**Change**” button.
3. A dialog box will appear asking you to **REMOVE** vessels from the sample stage. Click the “**OK**” button after removing all vessels.
4. The lens will rise automatically.
5. Rotate the lens counter-clockwise to remove it.
6. Rotate the new lens clockwise to install it.
7. Click the “**OK**” button on the dialog box, then the installed new lens will return to the home position in the bottom.
8. Click on the “**Done**” button to complete the lens change.

4.4.3 Calibration

For setting up the spatial calibration.

4.4.4 Service

This mode is for servicing purposes only.

5 Remote Monitoring

EzCapture is a Windows-based application. Thanks to the supportability of Windows operating systems, users can use the built-in Remote Desktop Connection or any 3rd party remote monitoring or remote desktop applications to monitor your sample from a remote location. After installation and internet connection, you can control the EzScope 101 remotely.

Here we list some examples of the 3rd party remote monitoring or remote desktop applications:

AnyDesk

<https://anydesk.com>

Chrome Remote Desktop

<https://chrome.google.com/webstore/detail/chrome-remote-desktop/gbchcmhmmhahfdphkhhkmpfmihenigjmpp?hl=en>

RealVNC

<https://www.realvnc.com>

TeamViewer

<https://www.teamviewer.com>

UltraVNC

<http://www.uvnc.com/home.html>

Please refer to the instructions provided by each application supplier for detailed setup and operation. Blue-Ray Biotech does not own the right to use any remote desktop application software. Please purchase desktop application software from the suppliers above directly.

6 Maintenance

6.1 Cleaning the Unit

The EzScope 101 requires minimal cleaning. Please unplug the power cable before cleaning. Clean the device with a lint free cloth or Kimwipe™ soaked with 70% ethanol.

Note
<ol style="list-style-type: none">1. Do not use acetone to clean the device or autoclave the device.2. Please avoid using too much ethanol solution that may leak into the machine.

6.2 Cleaning the LED Lamp Arm

Make sure the EzScope 101 is unplugged and the LED Lamp Arm has been removed from the EzScope 101. Clean the LED Lamp and LED Lamp Arm with a lint free cloth or Kimwipe™ soaked with 70% ethanol.

Note
Do not use acetone to clean the LED Lamp (Arm) or autoclave the LED Lamp (Arm).

6.3 Cleaning the Lens

Remove the Lens from the EzScope 101. Use a blower to remove dust particles on the lens if necessary. Drop 1 to 2 drops of 70% ethanol on lens tissue to wipe the Lens. Wipe the lens in a circular path from the center to the edge of the lens.

Note
<ol style="list-style-type: none">1. Do not use acetone to clean the Lens or autoclave the Lens.2. Do not spray or drop 70% ethanol directly on the Lens.

7 Troubleshooting

Problem	Cause	Action
EzCapture shows “Disconnected”.	Power is not reaching the system.	Confirm that the power source is present and correct. Reconnect the power adaptor.
	The USB data cable is not connected properly.	Reconnect the USB data cable.
The LED Lamp is not working.	The LED Lamp Arm is not installed correctly.	Reinstall the LED Lamp Arm. Make sure the mini USB of the LED Lamp Arm is plugged into the mini USB port of the EzScope 101. Tighten 2 screws with the hex wrench.
The Live View Window shows a white screen.	Strong illumination intensity.	Turn down the illumination (LED Lamp) intensity.
	Exposure is not set properly.	Adjust the Exposure on the Control Panel manually or check the auto box to enable auto exposure.
The Live View Window shows a black screen.	Weak illumination intensity.	Turn up the illumination (LED Lamp) intensity.
	Exposure is not set properly.	Adjust the Exposure on the Control Panel manually or check the auto box to enable auto exposure.
Captured image is blurred.	Focus is not set properly.	Adjust the Focus on the Control Panel .
	Vibration from the bench or the incubator.	Turn off or remove the machines that could cause vibration. For example, vortex and shaker.

7.1 Warning Messages

Message	Condition	Action
Please remove the sample on the platform and then press “OK”.	Lens change function was performed.	Remove the sample(s) on the platform to execute “Change Lens”.
Please press “OK” after lens has been changed.	After the lens has been changed.	Finish changing the lens, and press “OK”.

7.2 Error Messages

Code	Message	Cause	Action
Error 01	Motor failure (or home sensor failure)	After powering on the unit, the home sensor cannot detect the motor for over 25 seconds.	Unplug the power adaptor of the EzScope 101 and plug it back in after 30 seconds.
		During burn-in cycles, the home sensor cannot detect the motor after the motor passes end sensor for over 25 seconds.	Unplug the power adaptor of the EzScope 101 and plug it back in after 30 seconds.
Error 02	Motor failure (or end sensor failure)	When exchanging the lens, the end sensor cannot detect the motor for over 25 seconds.	Unplug the power adaptor of the EzScope 101 and plug it back in after 30 seconds.
		During burn-in cycles, the end sensor cannot detect the motor after the motor passes the home sensor for over 25 seconds.	Unplug the power adaptor of the EzScope 101 and plug it back in after 30 seconds.

If the same error message appears after rebooting the unit, please return the unit for service.

Appendix A: Technical Specifications

Optics	Brightfield (transmitted) with white LED
Objective Lens	10x, 20x (optional)
Camera	1.3 MP CMOS Sensor
Image Resolution	1280 x 1024 pixels
Export Formats	Tiff (image), AVI (video)
Software	EzCapture with snapshot, time-lapse, and confluence, etc.
Field of View	2.6 x 2.0 mm (10x objective)
Resolution	2 μm /pixel (10x objective) 1 μm /pixel (20x objective)
Live View Frame Rate	Up to 8 frames/second
Focusing	Motorized
Stage	
Manual XY Stage (optional)	SBS footprint
Labware Holders (optional)	35 mm culture dish and slide 60 mm culture dish and slide T-25 culture flask T-75 culture flask
General	
Computer Requirements	i3 CPU with 4 GB RAM, Windows 10 OS i5 CPU with 8GB RAM for multiple unit connection
Connectivity	USB 2.0/3.0, up to 4 units
Power Adaptor	Input: AC 100-240V, 50/60Hz, Output: DC 5V, 2A
Dimensions (W x D x H)	225 x 131 x 205 mm
Weight	2.0 kg
Operating Conditions	0°C - 42°C 5% - 95% RH non-condensing
Certifications	CE, RoHS

Appendix B: CE Declaration



BLUE-RAY BIOTECH CORP.
4F., No. 31, Sec. 2, Chang-An E. Rd.,
Zhong-Shan Dist., Taipei City 10456,
Taiwan (R.O.C.)

Declaration of Conformity

Product Name: EzScope 101

Model Names: BRLC-0101

All models comply with the following European standards:

EMC: CISPR 11: 2009 + A1: 2010

EN 61326-1: 2013, Table 1 (Basic)

EN 61326-2-6: 2013

EN 61000-3-2: 2014

EN 61000-3-3: 2013

IEC 61000-4-2: 2008

IEC 61000-4-3: 2006 + A1: 2007 + A2: 2010

IEC 61000-4-4: 2012

IEC 61000-4-5: 2014 + A1: 2017

IEC 61000-4-6: 2013

IEC 61000-4-8: 2009

IEC 61000-4-11: 2004 + A1: 2017

Safety: EN 61010-1 and EN 61010-2-010

To the best of my knowledge and belief, these units conform to these standards.

Name: **Jimmy Kuo**

Position: Quality Assurance Manager

Issue Date: 2019. 3. 15

Appendix C: Order Information

Cat. No.	Description
BRLC-0101	EzScope 101 Brightfield Live Cell Imaging System with 10x lens
275-LCBR02-00	20x lens
275-LCBR03-00	Mechanical XY Stage with 4 adaptors
275-LCBR04-00	35 mm Culture Dish and Slide Adaptor for XY Stage
275-LCBR05-00	60 mm Culture Dish and Slide Adaptor for XY Stage
275-LCBR06-00	T-25 Culture Flask Adaptor for XY Stage
275-LCBR07-00	T-75 Culture Flask Adaptor for XY Stage
ECEW-LC01	1-year Extended Warranty

Blue-Ray Biotech Corp.

4F., No. 31, Sec. 2, Chang-An E. Rd., Zhong-Shan Dist., Taipei City 10456, Taiwan (R.O.C.)

www.blue-raybio.com

P/N: 401-LCBR00-11