

HERASAFE 2030i Safety cabinets

Operating instructions

50155215

June, 14 th 2018

Copyright 2018

These operating instructions are protected by copyright. Rights resulting thereof, particularly reprint, photomechanical or digital postprocessing or reproduction, even in part, are only allowed with the written consent of Thermo Electron LED GmbH. This regulation does not apply to reproductions for in-plant use.

Trademarks

Heraeus is a registered trademark of Thermo Electron LED GmbH. All other trademarks mentioned in the operating instructions are the exclusive property of the respective manufacturers.

GPL (General Public License)

Some of the device software includes open-source software, which has been published under GPL, LGPL or another open source license. They include LGPLv2, zlib License, Apache 2.0 License and BSD License. The source texts (Material-No. 50156490) of the software can be obtained from Thermo Fisher Unity Lab Services.

Thermo Electron LED GmbH
Robert-Bosch-Straße 1
D - 63505 Langenselbold
Germany

Thermo Electron LED GmbH is a subsidiary company of:
Thermo Fisher Scientific Inc.
168 Third Avenue
Waltham, MA 02451
USA

Table of Contents

Chapter 1 General notes	1
General safety instructions	1
Warranty	2
Explanation of symbols.....	2
Symbols used in the operating instructions	2
Symbols on the device	3
Use of the device	4
Correct use	4
Incorrect use	5
Standards and safety regulations	5
Chapter 2 Delivery	7
Items Supplied.....	7
Acceptance inspection	7
Transport lock and device packaging	7
Chapter 3 Installation of the device	9
Ambient conditions	9
Room ventilation	10
Correct location	10
Installation in series	11
Anti-tilt anchor (Herasafe 2030i 1.5 and 1.8 only)	11
Connections	12
Power receptacles	13
Transport	13
Chapter 4 Unit description	15
Overall view.....	15
Safety system.....	16
Filter system.....	18
Controls and display.....	19
Sample chamber access	20
Device interfaces	22
UV lamp unit.....	25
Working area.....	26
SmartPort.....	26
Chapter 5 Start-up	29
Initial operation	29
Installing unit and accessories	29
Leveling the device	31
Power supply connection.....	32
Initial Setup	33
USB interface	36
Installation test	36

Chapter 6 Operation	39
Screen Layout	39
Info & Health Status Area	40
Main Screen (Region R2)	40
Control Panel (Region R2B)	43
Main Navigation Bar (Region R3)	45
Working Mode	46
Startup Mode	46
Standby Mode	47
Cleaning and Loading Mode	47
Idle Mode	48
Handling and Control	49
Using the Auxiliary Rocker Switch	49
Moving the Front Window to the Working Position	50
Lowering the Front Window	51
Switching the Sample Chamber Illumination On and Off	51
Activating and Deactivating the Internal Power Supply Receptacles	51
Activating and Deactivating the Internal Gas Supply	51
Logging into a Passcode-Protected Unit	52
Logging In	52
Logging Out	53
Running UV Disinfection	54
Starting the UV Disinfection Cycle	56
Turning the Fan On and Off During UV Disinfection	58
Restarting a Disrupted UV Disinfection Cycle	59
Alarms	60
Silencing and Handling Alarms	62
Alerts	63
Handling Alerts	65
Viewing General Status Information	66
Settings	68
Setting UV Disinfection Cycle Time	69
Alarms and Alerts Settings	70
Programs	76
Display Settings	80
Data Plate	86
Access Control	88
Factory Settings	89
Field Certification	89
Event Log	90
Viewing the Event Log	91
Filtering the Event Log	92
Exporting the Event Log	93
Chapter 7 Preparation	95
Hygiene preparations for the sample chamber	95
Preparing the sample chamber	95
Response to failure messages	96
Work rules	96

Chapter 8 Shut-down	99
Interrupting an operation	99
Shutting the unit down	99
Chapter 9 Cleaning and decontamination	101
Decontamination procedure.....	101
Wipe/spray disinfection	101
UV disinfection after a wipe/spray disinfection	103
UV disinfection using the integral UV lamps	103
Changing the UV disinfection time	103
Disinfection with formaldehyde	103
Cleaning the exterior surfaces	104
Cleaning the front window.....	104
Cleaning the drain pan.....	104
Chapter 10 Maintenance	105
Inspection	105
Service	105
UV lamps	105
Sample chamber illumination	106
Replacing the front cover seal	106
Exchanging SmartPorts	107
Retrofitting and repairs.....	107
Chapter 11 Disposal	109
Disposal procedure.....	109
Chapter 12 Technical data.....	111
Chapter 13 Device log	115
Chapter 14 Certificate of decontamination.....	117

Figures

Figure 1 Correct location.....	10
Figure 2 Lift points	13
Figure 3 Overall view, version HERAsafe 2030i	15
Figure 4 Filter system with downflow filter and exhaust air filter	18
Figure 5 Controls and display	19
Figure 6 Access through front cover	20
Figure 7 Access through front window	21
Figure 8 Supply interfaces	22
Figure 9 Workspace illumination.....	24
Figure 10 UV lamp unit.....	25
Figure 11 Working area on the workplate, armrests.....	26
Figure 12 Stand installation.....	30
Figure 13. Initial Startup: Startup Screen.....	33
Figure 14. Initial Setup: Setting the Language	33
Figure 15. Initial Setup: Setting the Date	34
Figure 16. Initial Setup: Setting the Time of Day in 12hr, AM/FM Format	34
Figure 17. Initial Setup: Setting the Time of Day in 24hr CET Format	35
Figure 18. Initial Setup: Completing the Initial Setup	35
Figure 19. Main Screen - Unit in Idle State, Window Closed	35
Figure 20 USB interface.....	36
Figure 21 USB interface display.....	36
Figure 22 Screen Areas	39
Figure 23 Info & Health Status Area.....	40
Figure 24 Main Screen	41
Figure 25 Overview of Side-View Symbol Graphics for Unit Status	42
Figure 26 Control Panel for Fully Equipped Unit	43
Figure 27 Control Panel for Unit without Gas Option.....	44
Figure 28 Buttons on the Control Panel.....	44
Figure 29 Tooltip Bubble over Window Close Button	45
Figure 30 Main Navigation Bar	45
Figure 31 Main Screen - Unit Working	46
Figure 32 Main Screen - Unit Starting Up.....	46
Figure 33 Main Screen - Unit in Standby.....	47
Figure 34 Main Screen - Unit Cleaning	48
Figure 35 Main Screen - Unit in Idle State, Window Closed	48
Figure 36 Main Screen - Unit in Idle State, Window Open	49
Figure 37 Basic Functions of the Auxiliary Rocker Switch	49
Figure 38 Info & Health Status Area with Login Prompt.....	52

Figure 39 Login Window 53

Figure 40 Log Out Window 53

Figure 41 Log Out Screen: Logged Out Message 54

Figure 42 Main Screen: UV Disinfection Running 54

Figure 43 Main Screen: Disinfection Running with Adjustment for Bulbs 55

Figure 44 UV Cycle Alert When Light Bulb Button is Tapped During UV Disinfection 56

Figure 45 Tooltip Bubble over Window Close Button 56

Figure 46 UV Cycle Alert When Window is Open / Illumination is On 57

Figure 47 UV Disinfection Cycle Complete Alert 57

Figure 48 Reduced Flow Mode Alert During UV Disinfection Cycle 58

Figure 49 Fan Button in Off Mode vs UV Disinfection Mode 58

Figure 50 Reduced flow is now off Alert 59

Figure 51 Fan Button in UV Disinfection Mode vs Off State 59

Figure 52 UV Disinfection Cycle was Disrupted Alert 59

Figure 53 Alarming Screen for Downflow Too High and Too Low Alarm 60

Figure 54 Health Status Alarm Icon („Alarm Bell“) in Unsnoozed and Snoozed Modes 61

Figure 55 Alarming Screen with Snoozed Alarm 61

Figure 56 Health Status Alarm Screen 61

Figure 57 Main Screen After Two Cycles of Alarm Ticker Message 62

Figure 58 Alert Screen with Filter Replacement Reminder 63

Figure 59 Status Warning Screen with Alert Screen Message, Status Alert GFI 64

Figure 60 Types of Alerts and Their Specific Icons 64

Figure 61 Main Screen After Two Cycles of Alert Ticker Message 64

Figure 62 GFI Tripped Alert Details Screen 65

Figure 63 Status Good Screen #1: Operating Hours, UV and Filter 66

Figure 64 Health Status Good Screen #2: UV, Filter and Air speed 67

Figure 65 Settings Screen 68

Figure 66 Disinfection Cycle Settings Screen 69

Figure 67 Settings Saved Pop-up Windows for Disinfection Cycle Settings 70

Figure 68 Alarms and Alerts Settings Screen 71

Figure 69 Alarms and Alerts Settings: Alarm Volume Options 71

Figure 70 Alarms and Alerts Settings: Window Alarm Tone Options 72

Figure 71 Alarms and Alerts Settings: Airflow Alarm Tone Options 72

Figure 72 Alarms and Alerts Settings Window with Snooze Timeout Options Expanded 73

Figure 73 Alarms and Alerts Settings: Alert Volume Options 74

Figure 74 Alarms and Alerts Settings: Alert Tone Options 74

Figure 75 Settings Saved Screen 75

Figure 76 Changes Not Saved Message 75

Figure 77 Programs Screen 76

Figure 78 Programs: Edit AutoStart Screen 77

Figure 79 Programs: Edit AutoStop Screen 78

Figure 80 Display Settings Screen 80

Figure 81 Display Settings: Language Screen 81

Figure 82 Units Of Measure Dropdown Menu 82

Figure 83 Display Settings: Unit Name Screen 83

Figure 84 Display Settings: Changing Unit Name Screen 83

Figure 85 Display Setting: Date Screen 84

Figure 86 Display Setting: Time Screen with 12-hour AM/PM Format 85

Figure 87 Display Setting: Time Screen with 24-hour Format 85

Figure 88 Display Setting: Menu Bar Customization Screen with Icon Swapping Options 86

Figure 89 Data Plate Screen 87

Figure 90 Data Plate: Contact Us Screen 87

Figure 91 Data Plate: Editing the Contact Us Screen 88

Figure 92 Access Control Screen in Open Mode 88

Figure 93 Access Control Screen in Secure Mode 89

Figure 94 Event Log Screen 90

Figure 95 Event Log Screen: Standby Mode Expanded 92

Figure 96 Filtering the Event Log 92

Figure 97 Export Log Screen: Missing USB Drive Alert 93

Figure 98 Export Log Screen: Exporting Event Log in Progress Message 94

Figure 99 Event Log Screen: Export Completed 94

Figure 100 Sitting posture 97

Figure 101 Replacing the front cover seal 106

General notes

The following are the addresses of the international Thermo Sales Organisations.

Postal address Germany

Thermo Electron LED GmbH
Robert-Bosch-Straße 1
D - 63505 Langenselbold

Enquiries from Germany

Phone

Sales 0800 1 536376
Service 0800 1 112110

Fax

Sales/Service 0800 1 112114

E-Mail

info.labequipment.de@thermofisher.com

Enquiries from Europe, Middle East and Africa

Tel. + 49 (0) 6184 / 90-6940
Fax + 49 (0) 6184 / 90-7474

Enquiries from North America:

Phone +1 800-879 7767 +1 800-879 7767
Fax +1 828-658 0363

Enquiries from Latin America:

Phone +1 828-658 2711
Fax +1 828-645 9466

Enquiries from Asia Pacific:

Phone +852-2711 3910
Fax +852-2711 3858

E-Mail

info.labequipment@thermofisher.com

General safety instructions

These safety instructions describe the safety features of the HERAsafe 2030i series. The safety cabinet has been manufactured in keeping with the latest technological developments and has been tested before delivery for its correct function. It may, however, present potential hazards if it is not used according to the intended purpose or outside of operating parameters. Therefore, the following procedures must always be observed:

- The safety cabinet must be operated only by trained and authorized personnel.

- For any operation of this unit, the operator must prepare clear and concise written instructions in the language of the operating and cleaning personnel based on these operating instructions, applicable safety data sheets, plant hygiene guidelines, and technical regulations, in particular:
 - which decontamination measures are to be applied for the cabinet and accessories,
 - which protective measures apply while specific agents are used,
 - which measures are to be taken in the case of an accident.
- Repairs to the device must be carried out only by trained and authorized expert personnel.
- The contents of the operating instructions are subject to change without further notice.
- Concerning translations into foreign languages, the German version of these operating instructions is binding.
- Keep these operating instructions close to the unit so that safety instructions and important information are always accessible.
- Should you encounter problems that are not detailed adequately in these operating instructions, please contact Thermo Electron LED immediately for your own safety.



Impairment of the system may lead to hazards.

Warranty

Thermo Electron LED warrant the operational safety and functions of the safety cabinet only under the condition that:

- the device is operated and serviced exclusively in accordance with its intended purpose and as described in these operating instructions,
- the device is not modified,
- only original spare parts and accessories that have been approved by Thermo Electron LED are used,
- inspections and maintenance are performed at the specified intervals,
- an installation test is performed prior to the initial operation of the device and that a repeat test is performed on the occasion of all inspections and repairs.

The warranty is valid from the date of delivery of the device to the operator.

Explanation of symbols

Symbols used in the operating instructions



Is used if non-observance may cause serious or even lethal injuries.



Is used if non-observance may cause medium to minor injuries or damage.

NOTE
is used for hints and useful information.



Valuable raw materials can be reused.

Symbols on the device

Observe operating instructions (cover of electrical box)



Biohazard (left device front)

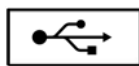

USB interface



CE conformity mark: confirms conformity according to EU Directives



GS sign TÜV Nord



Filter replacement



2 x T5A outlet fusing



2 x T 15 AH



2 x T 16 AH Equipment Fusing

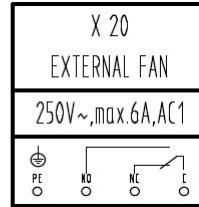
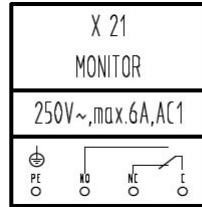
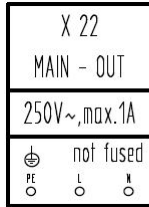

X20 connection for an external fan
 X21 connection for a solenoid valve
 X22 connection for an external component

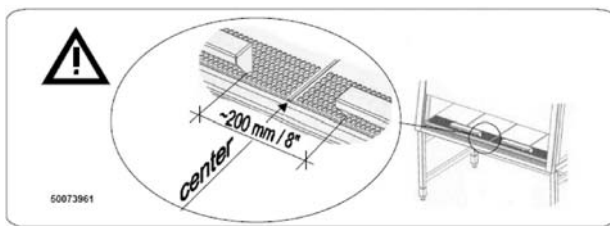

Armrest installation



UV lamp

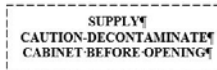
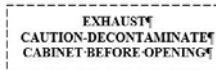

Exhaust and supply lines

Use of the device

Correct use

HERAsafe 2030i version:

The safety cabinet is a laboratory device for installation and operation in microbiological and biotechnical laboratories of safety levels 1, 2, and 3. It has been designed as a Class II microbiological safety cabinet, in accordance with EN 12469:2000.

Depending on the hazard level of the agents involved, the operator must prepare in writing appropriate decontamination procedures for the device and the accessories used in the sample chamber.

Following media should be used:

- Vacuum (Rough vacuum 10 E-2 bar / 0,145 psi)
- Combustible gas (e.g. Propane)
- Non-combustible gas (e.g. Nitrogen)

Incorrect use

The safety cabinet must not be used in laboratories that do not comply with the requirements of safety levels 1, 2, and 3.

The unit must not be operated as a Class II safety cabinet if:

- no repeat test is performed after changes to the installation conditions or after modifications to the technical system.
- the alarm system of the device has issued a failure message and the cause for the failure has not been repaired.

The alarm system must not be tampered with or disabled. If alarm system components have been removed or disabled for service or repairs, the unit must only be released for operation if all alarm system components are functioning again properly.

The filters installed in the device are not capable of separating gaseous substances. Therefore, do not work with or store substances in the device:

- are toxic which in quantity or concentration,
- if a reaction with other substances may result in hazardous toxic concentrations or formation of toxic gases,
- that may form combustible or explosive mixtures in combination with air.

Standards and safety regulations

The device complies with the safety requirements of the following standards and guidelines:

- IEC 61010-1:2010 / EN 61010-1:2010
- EN 12469:2000
- Low Voltage Directive 2014/35/EU
- EMC Directive 2014/30/EU

Delivery

Items Supplied

Delivery for the safety cabinet includes the following:

HERAsafe 2030i version:

- safety cabinet
- armrests
- Device documentation with:
 - operating instructions (CD)
 - factory test report
 - summarized safety instructions (SSI)
 - HEPA filter certificate

Optional components and accessories are listed as separate items in the delivery document.

Acceptance inspection

After the device has been delivered, immediately check the device:

- for completeness,
- for possible damage.

If the delivery is incomplete or if you detect any transport damage to the device, contact the forwarding agency and Thermo Electron LED immediately.

Transport lock and device packaging

Do not transport the device over large distances without transport lock and original device packaging.

Installation of the device

Ambient conditions

The operational safety and correct function of the unit depend on the location where it is to be operated. The safety cabinet must be operated only at locations that meet the ambient conditions listed below.

Location requirements:

- The electrical system of the device has been designed for an operating height of up to 2000 m above sea level.
- The mains power supply outlets should be out of casual reach to prevent accidental shut-off. Ideally, the outlets should be installed above the safety cabinet and be readily accessible.
- The flooring of the location must be adequately strong and not flammable.
- The support frame must be designed with an adequate load-carrying capacity (supporting four times the weight of the device).
- The room in which the device is installed must be of adequate height. For units not connected to an exhaust system, the distance between the exhaust air opening and the room ceiling must be at least 200 mm. There is potential to install with a lower clearance of 200mm. This should be discussed with a Thermo Fisher Scientific BSC specialist.
- The location must be equipped with an appropriate ventilation system, see “Room ventilation” on page 10.
- The temperature within the room must be between 15 °C and 40 °C.
- The power supply voltage should not vary by $\pm 10\%$ from its nominal value.
- Transient overvoltage peaks shall not exceed the usual range prevailing within the AC power supply grid. The nominal transient overvoltage level shall be the surge withstand voltage according to overvoltage category II of IEC 60364-4-443.
- An appropriate ground fault circuit interrupter must be installed by the customer to protect the device system.
- Condensation must be avoided, for example, subsequent to relocation or transport. Should condensation exist, wait for the humidity to evaporate completely before connecting to a power source or powering up the device.
- The relative humidity in the vicinity of the device must not exceed 90 %.

NOTE Ambient conditions

If ambient conditions vary from those described above, please contact Thermo Electron LED for assistance in installing the device.

NOTE Temporary storage

If the device is stored only temporarily (up to four weeks), the ambient temperature may be between -20 °C and +60 °C (-4 °F and +140 °F) at a relative air humidity of up to 90 %. For longer storage periods, the location requirements apply.

Room ventilation

The room ventilation should preferably be a ventilation system that complies with the national requirements for the application.

- The inlet air and exhaust air openings of the room ventilation must be located so that drafts are prevented from impairing the function of the safety cabinet air system.

Correct location

Choose a draft-free location where the safety cabinet does not interfere with the plant traffic.

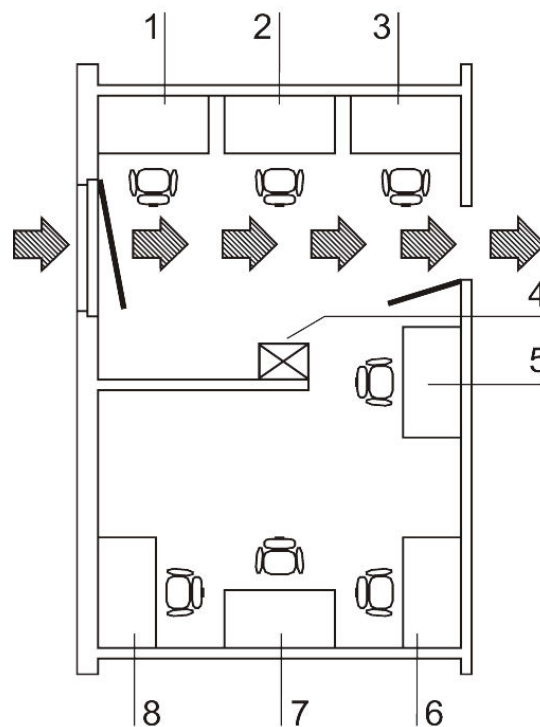

Figure 1 Correct location

This figure shows preferred locations for safety cabinets and unsuitable locations, not in accordance with the safety requirements.

Unsuitable locations: The locations [1], [2] and [3] are not suitable because they are exposed to drafts from windows and doors.

Location [5] is undesirable because it is in range of plant traffic and within the exhaust air range of a ventilation system [4].

Preferred locations: Preferred locations [6], [7], and [8] are correct because they are in a draft-free section of the room and not exposed to plant traffic.

Installation in series

When several devices are to be installed in series, please observe the following:

- Make sure that vibrations cannot be transferred between adjacent units,
- exterior surfaces of the cabinets must always be accessible for cleaning and disinfection,
- minimum distance of 2 m (6.6 ft.) between workbenches on opposite position.

Anti-tilt anchor (Herasafe 2030i 1.5 and 1.8 only)

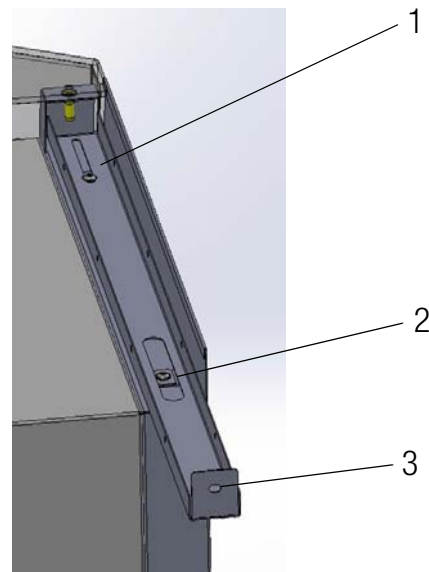
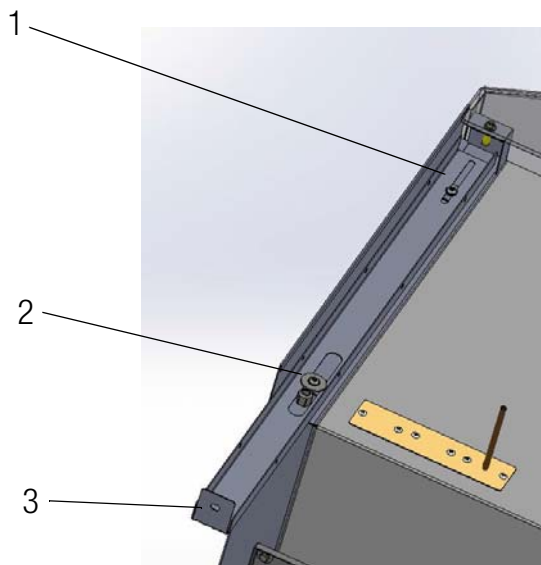
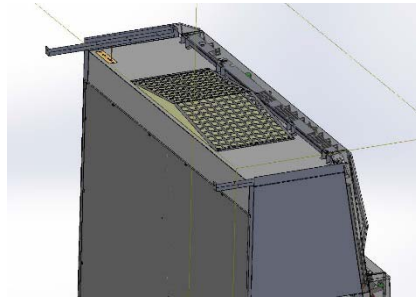

NOTE

Always make sure to secure the rear side of the safety cabinet to the wall by mounting the left and right anti-tilt anchors!



Unsafe part of the building!

Install the anti-tilt anchor to a solid part of the building, which is able for shoring loads.

The installation has to be carried out by qualified personnel only.

The connection to the building must be carried out with appropriate fastening fixtures according to the consistence of the building part.

The oblong holes (1) allow for adjusting the position of the anti-tilt anchors by up to 70 mm.

Secure the mounting position using the M5 screws (2).

Connections

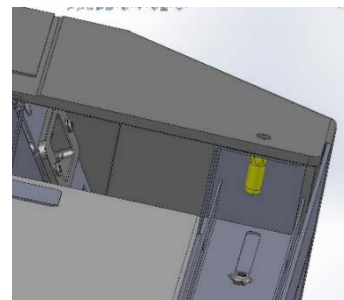
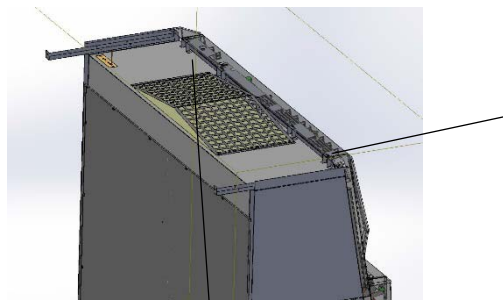

Power cable

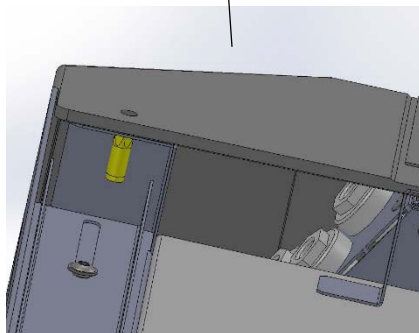

X22 X21 X20



Cable glands allow for connecting up to 3 external devices.
 Connect directly to the printed circuit board!
 Caution! Make sure the max. current output is not exceeded!

X 22 MAIN - OUT 250V~,max.1A not fused PE L N	X 21 MONITOR 250V~,max.6A,AC1 PE N MC C	X 20 EXTERNAL FAN 250V~,max.6A,AC1 PE N MC C
---	--	---

X22 230V Power Supply / X21 Monitor Alarm / X20 External Fan

The leads can be attached on the outer face of the anti-tilt anchor using cable ties.

Power receptacles



Each power receptacle is fused using a T 5A slow-blow fuse.

Transport

Version HERAsafe 2030i:

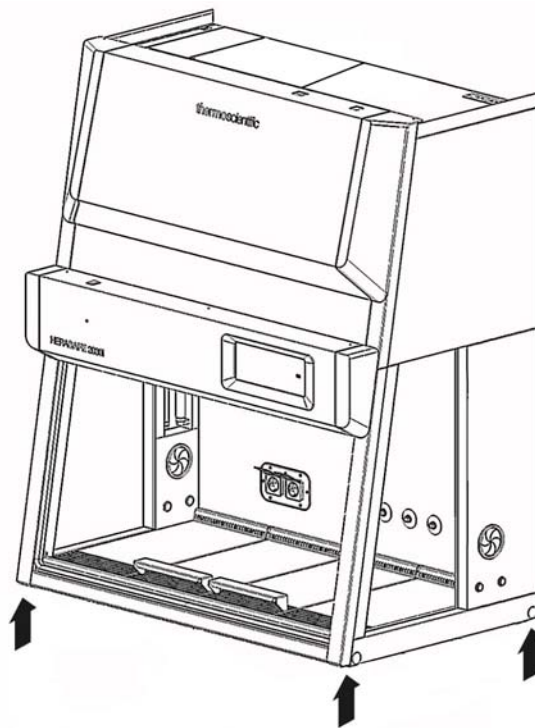

Figure 2 Lift points

To prevent tilting, always transport the device using a suitable carrier, even for a transport within a building, and separate it from the stand.



Danger of tipping over!

For transport, lift the device only using the lift points shown in the illustration.

Do not load the drain pan with the weight of the device frame!



Contusion hazard!

When lifting the safety cabinet, do not put hands or fingers between drain pan and frame!

Unit description

Overall view

Version HERAsafe 2030i:

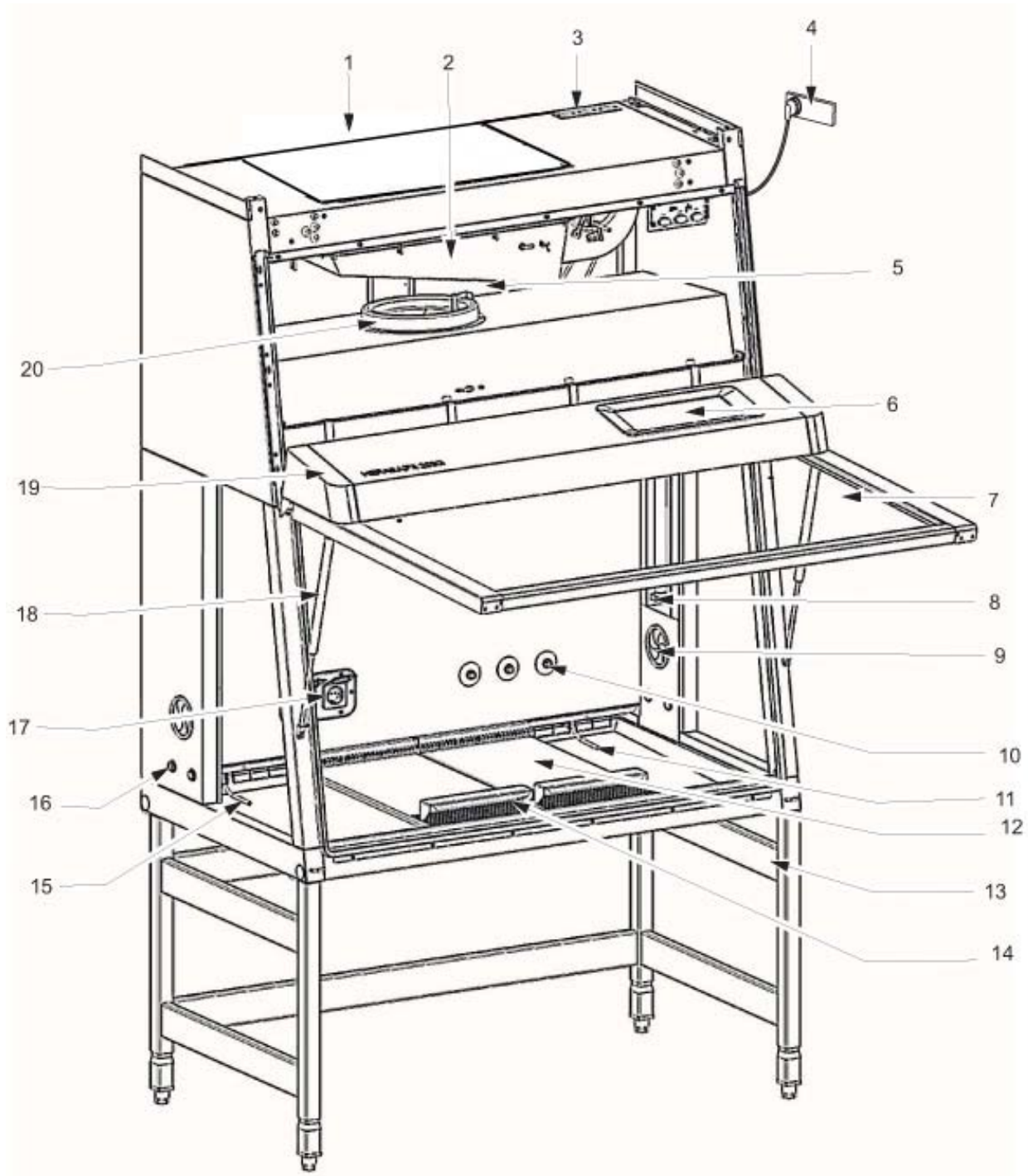

Figure 3 Overall view, version HERAsafe 2030i

- Plenum assembly [5] with plenum for downflow blower [20] and plenum for exhaust air blower [2]. The downflow filter and the exhaust air filter are installed directly to the pertaining blower. The exhaust air is released into the environment around the device through the opening [1].

- At the top side of the plenum, the optional media supply lines [3] are routed into the sample chamber [10].
- Power supply cable [4] and two fuse holders [3]. An USB connection to a PC or to download data log is installed at the GUI display [6].
- Front cover [19] with integral, electrically movable front window [7]. An auxiliary rocker switch for basic BSC window operation is located on the top left of the light dome.

The gas struts [18] secure the front cover in the open state.

Optionally, two safety latches can be installed to the front cover so that the door can be protected against unauthorized opening.

- The light dome [19] with two tubes is part of the front cover assy.
- Side slates with two sealed access openings [16]. These can be equipped with media valves.
- Internal outlets [17] for power supply of accessories.
- Optional UV lamp unit [8] consisting of two UV lamps per side.
- Optional stands [13], adjustable in height and with fixed height.
- Workplate segments [12] with optional arm rests [14]. A one-piece workplate and special work plates are available options.
- GUI Operating Panel [6] with cabinet controls, alarm system indicators, and cabinet status display.
- Test hoses for the supply unit [15] at the left side of the workspace and for the exhaust unit [11] at the right side of the workspace.

NOTE Test hoses

Do not remove the two test hoses for checking downflow and exhaust air.

Safety system

The safety system comprises a combination of protective and alarm systems that ensure maximum personal and material protection.

Safety systems:

- **Vacuum-sealed air system**

An air system in combination with HEPA filters for downflow and exhaust air forms the basis of the safety system for personal and material protection.

- **Personal protection**

Air aspirated from the exterior along the entire working opening at a constant high velocity prevents that:

- agents may leak through the working opening of the chamber.

As the exterior air pressure around the unit exceeds the pressure of the internal air system, it is ensured that:

- agents cannot be released to the exterior in the case of a leak in the cabinet housing.

- **Product protection**

A steady airflow within the air system ensures that:

- a constant downflow allows the HEPA filters to remove contaminants so that the samples are always surrounded by ultrapure air,
- harmful particles are not carried over through the sample chamber (protection from cross-contamination).

- **HEPA filters**

The downflow (i.e. the air circulating within the device) and the exhaust air (air that is released to the exterior) are cleaned by HEPA filters (HEPA = High Efficiency Particulate Air Filter).

- **Safety lockout**

To protect from UV radiation, the optional UV disinfection routine can be run only if the front opening is closed. During UV disinfection, the front opening safety lockout is activated and prevents harmful UV radiation from being emitted from the sample chamber.

- Media connections and components are to be installed by expert personnel only.

Warning system:

- **Airflow monitoring**

Airflow monitoring determines the velocity of the airflow in the sample chamber as well as the inflow velocity of the air aspirated from the exterior through the working opening. As soon as airflow velocities move above or below a specified safety value, a signal is transmitted to the alarm system.

- **Visual and audible alarm system**

The warning system constantly monitors the safety-relevant device functions:

- Inflow velocity of the air aspirated from the exterior,
- downflow velocity,
- working position of the front window.

If the warning system detects changes to one of these device functions, it issues:

- an audible and a visual alarm signal.

- **Position monitoring**

The position sensors monitor the position of the front window; it will indicate when the front window is in the working position.

Filter system

Version HERAsafe 2030i

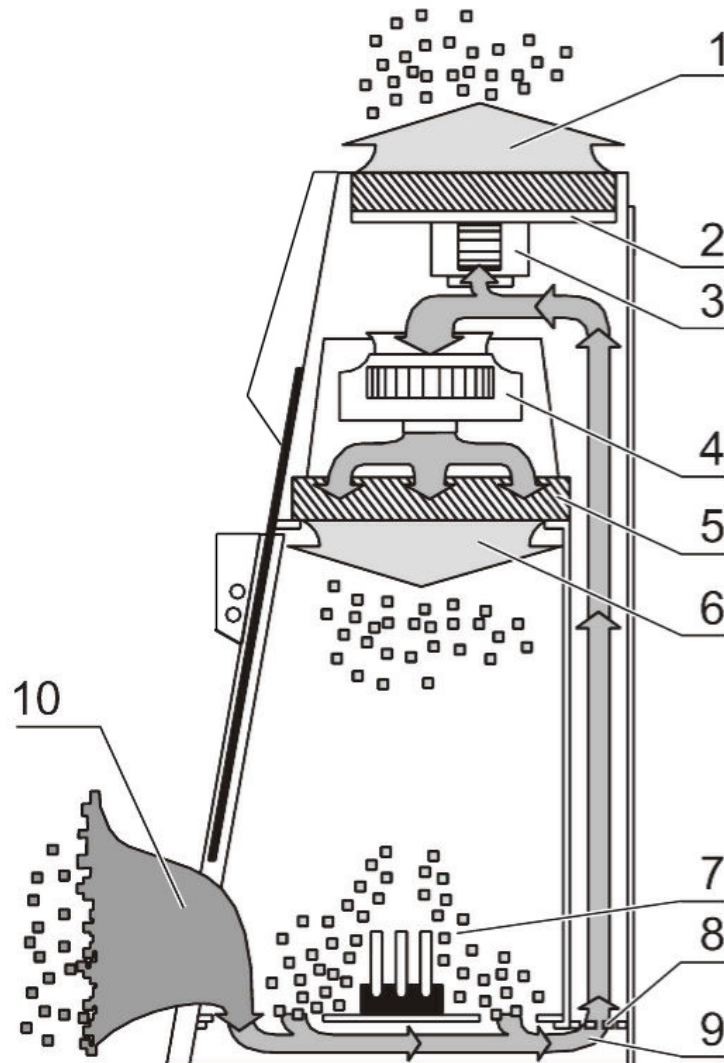

Figure 4 Filter system with downflow filter and exhaust air filter

The filter system consists of two HEPA filters [2] and [5] for the circulating air and for the exhaust air and a coarse filter for the aspired air.

HEPA filters: Room air [10] is drawn into the sample chamber through the working opening. In the air duct, room air and the downflow within the chamber [7] are then blended to make up the blend air [9]. The blend air is then:

- filtered proportionally by the downflow filter [5] and supplied as ultrapure air [6] evenly into the sample chamber of the device,
- filtered by the exhaust air filter [2] and released as ultrapure air [1] to the exterior of the device.

Inlet air protection: The air duct between the sample chamber and the device plenum has an inlet air protection [8] below the working surface to prevent coarse particles from entering the plenum where they may impair blower [3] and [4] and filter functions.

Controls and display

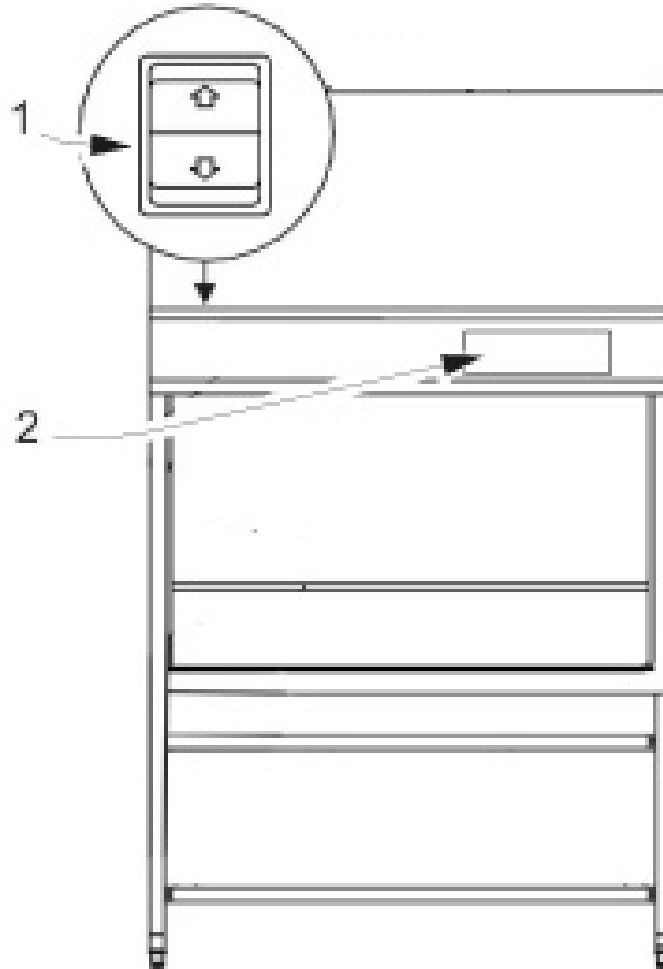

Figure 5 Controls and display

The safety cabinet is equipped with two separate control elements that operate independently of each other:

- auxiliary rocker switch [1] to move the front window up and down
- GUI - Graphical User Interface [2]

The status indicators of the display [2] indicate control operations initiated with the control elements.

In the GUI the current status of the cabinet is shown.

Sample chamber access

The sample chamber of the device is accessible via two modes.

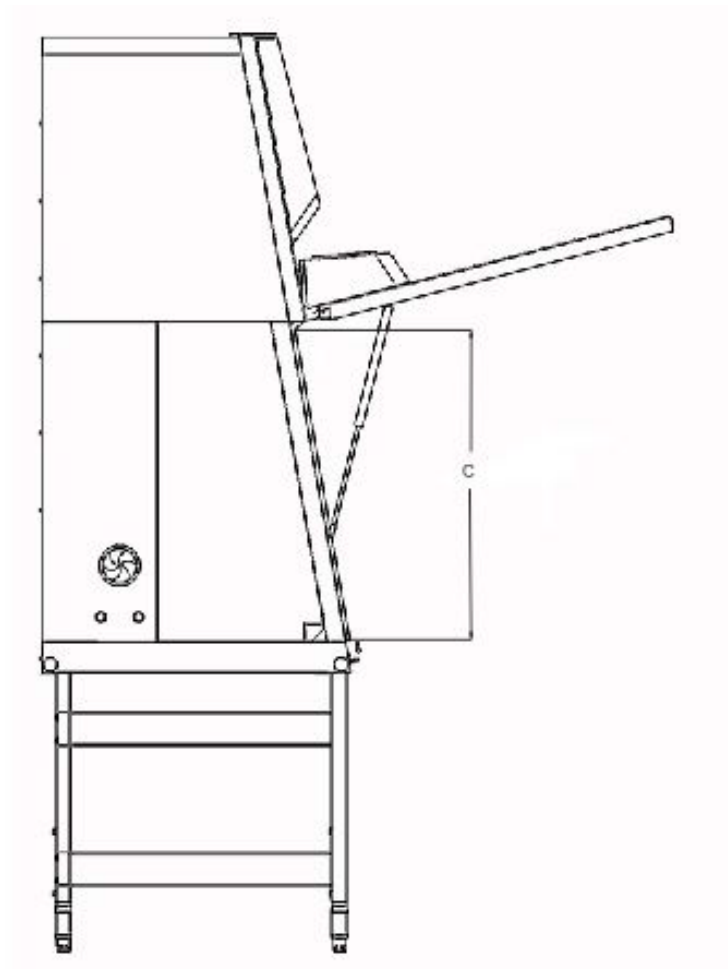

Figure 6 Access through front cover

Front cover:

Manual opening of the front cover [1] allows access to the complete sample chamber width with an opening height C. It is generally needed for decontamination and introduction of larger accessories.

NOTE Front cover lockout

The front cover is equipped with a safety lockout and can only be opened in standby mode, i.e. when the front window is completely closed.

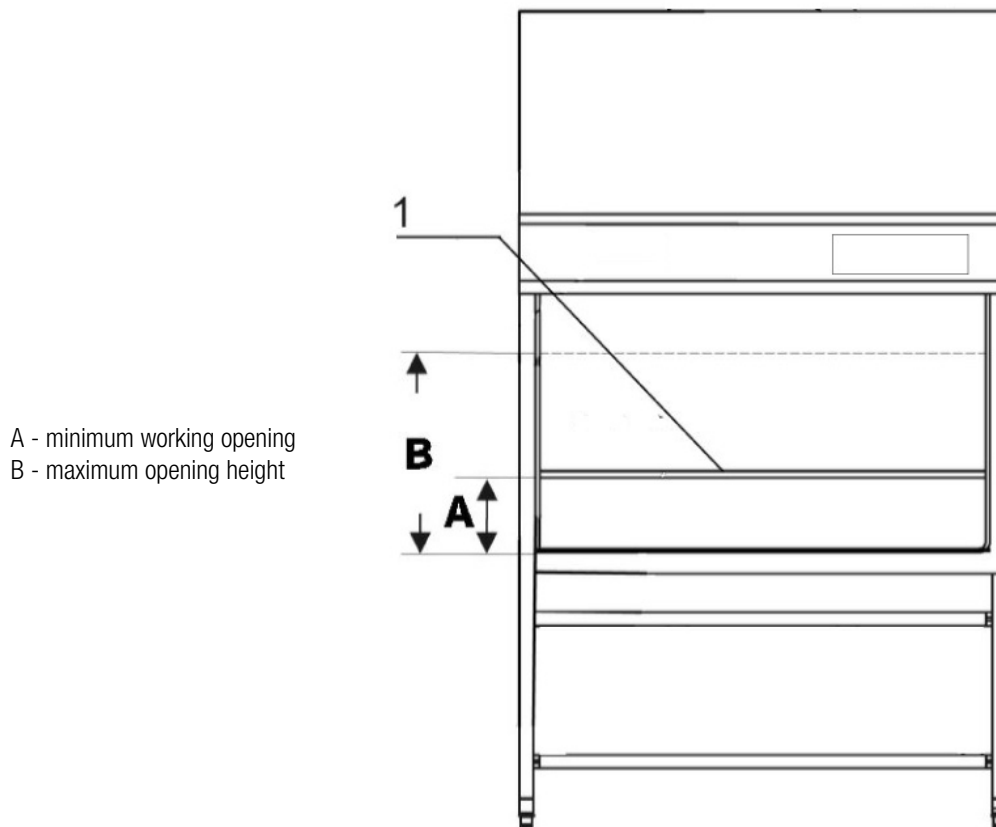

Figure 7 Access through front window

Front window:

The electrically operated front window [1] is made of multi-layer safety glass and integral to the front cover frame. It can be raised to a maximum opening height B. To access the sample chamber during the work process, the front window must stay in the work position with opening height A.



Crushing hazard

During movement of the front window do not try to access the inner chamber.



Front window movement!

Do not attempt to move the front window manually as otherwise the motor drive may be damaged.

Lowering the front window when the device is deenergized:

The safety feature is backed up by a battery. Should a power failure occur, the auxiliary rocker switch (see “Using the Auxiliary Rocker Switch” on page 49) can be used to lower the front window completely.

Device interfaces

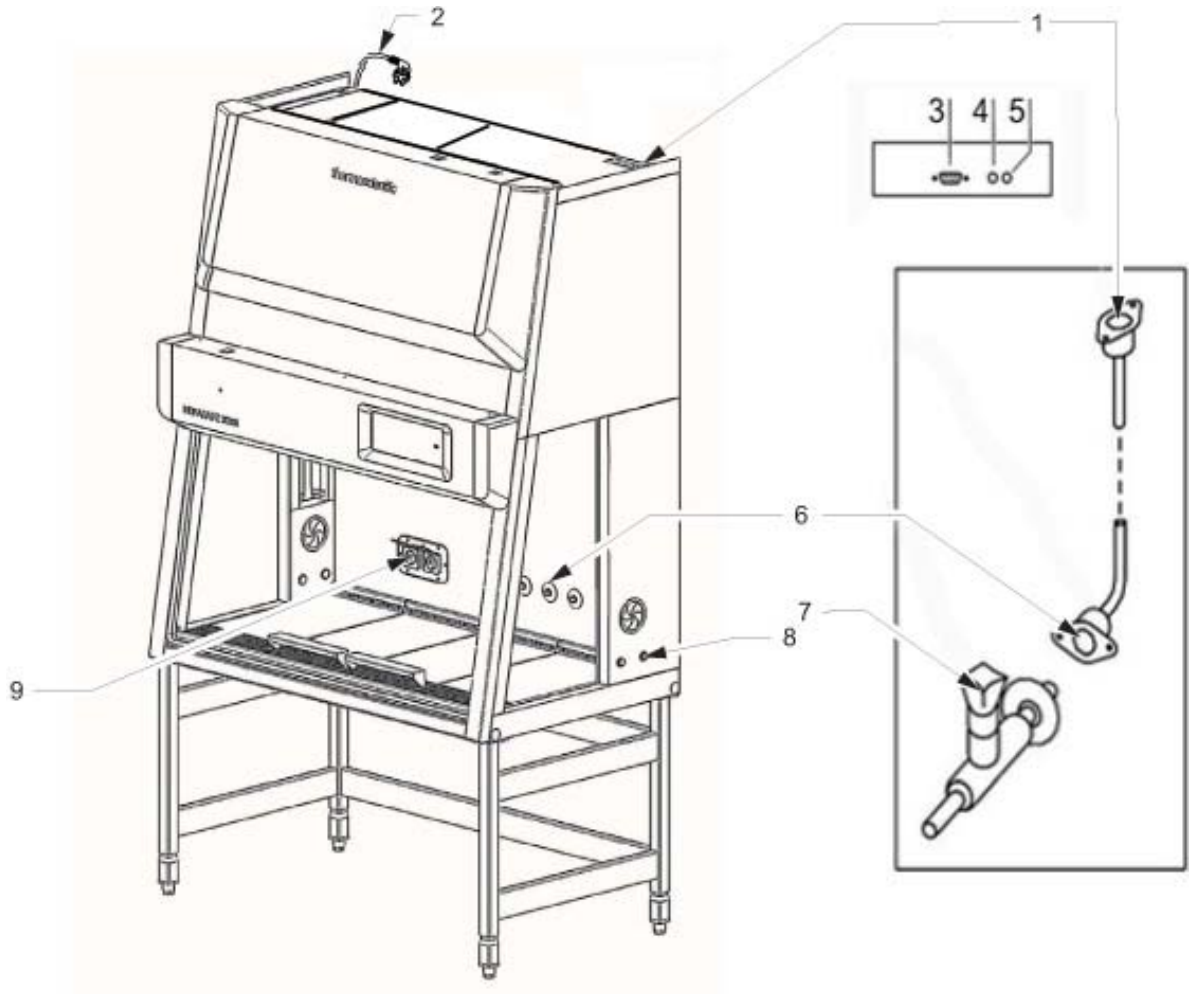

Figure 8 Supply interfaces

The standard equipment includes the outlets [9] for internal power supply as well as the SmartPort and openings [8] on both sides for routing of cables and hoses. All other supply connections are available as options and may also be retrofitted.

Power supply connection: The connection to the power supply system is achieved through a cable with grounding plug [2].

Contact: At the top side an USB interface [3] for Service is installed. Two fuse holders for 5A miniature fuses are located at the top rear of the cabinet:

[4] for L-Phase,
[5] for N-Neutral.

Internal power supply: There is one electrical outlet (5A) [9] located on the rear wall.

Feed throughs: There are two sealed feed throughs [8] on each side. These may be used for installation of media valves [7]. On delivery they are sealed with plastic stoppers.

Media connections (optional): The media supply unit consists of three pipes that are routed into the sample chamber through the top of the unit. The inlet connections [1] and outlet connections [6] with thread (R 3/8"), e.g. for media valves [7], are preinstalled and equipped with a sealing plug.

The media connections are universal-type connections. One equipotential bonding connection is installed at the top of the unit.

NOTE

The connection of the piping and media valves has to be carried out according to country specific standards and by expert personnel only.

**Combustible gas!**

The use of a gas burner is not recommended.

If a gas burner is to be operated in the sample chamber, then a low profile burner should be used and an appropriate shut-off device for the gas supply system (shut-off valve, solenoid valve) must be installed.

Use only laboratory safety burners in the sample chamber.

External systems: Failure detection systems or gas supply solenoid valves may be connected to the safety cabinet control.

Workspace illumination

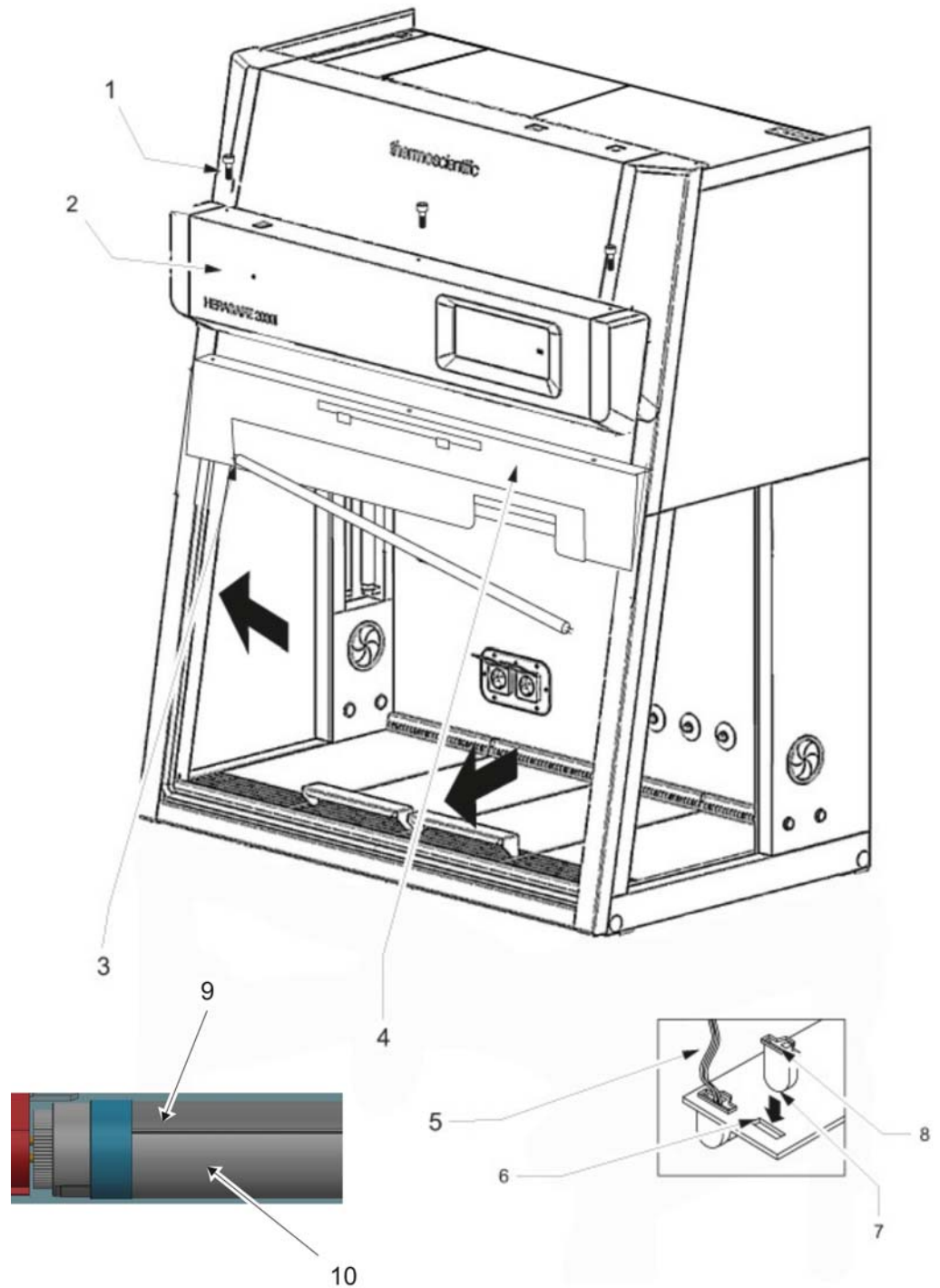

Figure 9 Workspace illumination

The workspace illumination [2] is equipped with two LED that are installed behind the light dome [3].

NOTE

The Reflector side (9) must be installed upwards, so that the radiation side (10) is fully active.

UV lamp unit

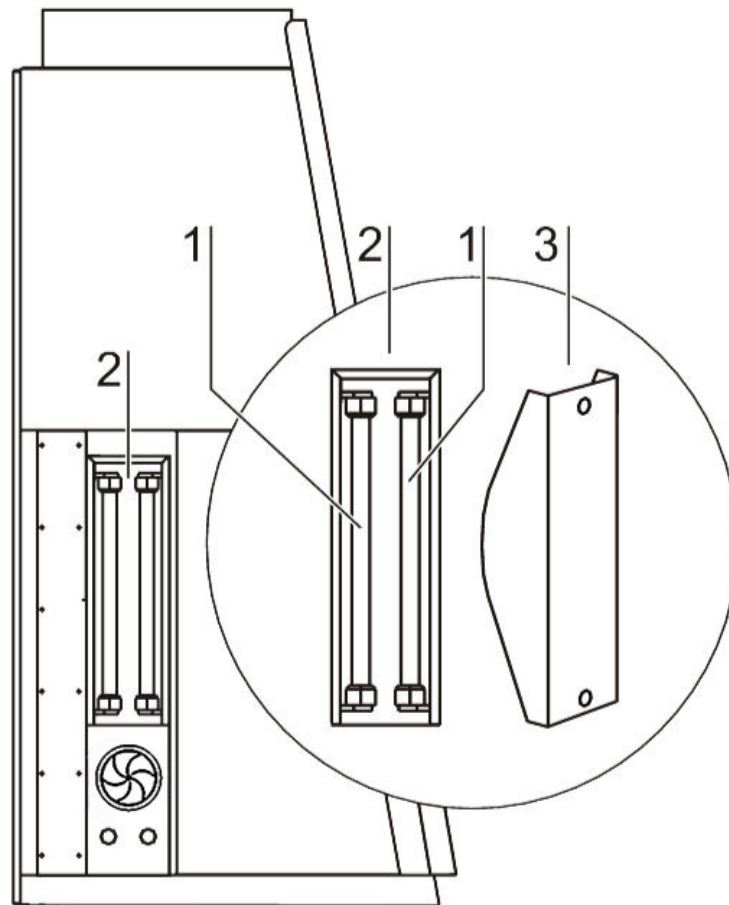

Figure 10 UV lamp unit

The UV lamp unit consists of two lamp housings [2] with two UV lamps each [1] that are integral to the side walls. Both lamp housings are protected by a stainless steel cover [3].

By cross-radiation of the UV units, all surfaces will be disinfected as the shadow zone is reduced. The operating time of the UV lamps is preset and can be changed by the operator.

NOTE Protection from UV radiation

As a protection from harmful UV radiation, the UV lamps can only be activated if the front window is completely closed.

Working area

The standard equipment comprises the segmented workplate for the HERAsafe 2030i. Special workplates are available as optional accessories. The workplates or workplate segments are placed onto the frame above the workspace drain pan.

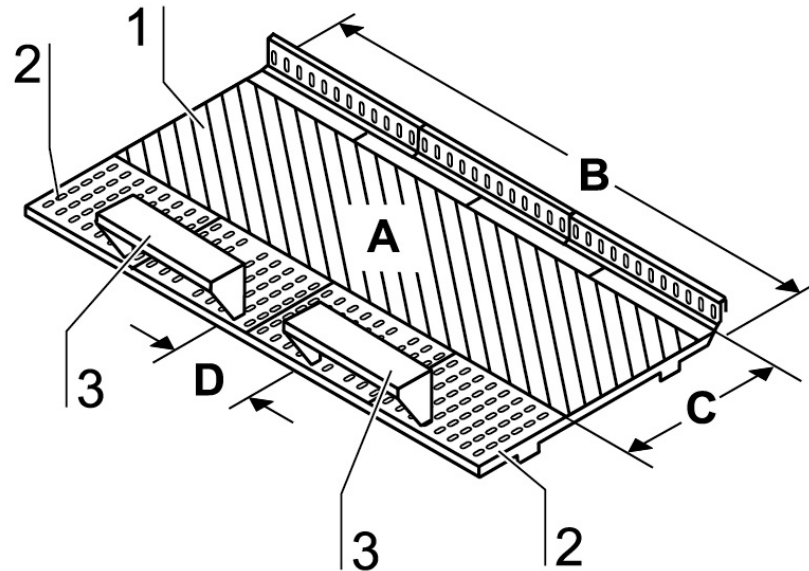

Figure 11 Working area on the workplate, armrests

The working area A for perfect material protection extends over the entire width B and depth C of the workplate [1]. The two arm rests [3] are positioned at a distance D (20 cm) to each other centrally on the workplate [1] or on the workplate segments. The armrests are installed to the second perforation line [2] of the workplate.



The 2 armrests (3) are safety relevant component parts!

SmartPort

Installation of low voltage cables and hoses:

The low voltage cables and hoses that are used must be designed for the purposes intended. Hoses have to be < 10 mm (Ø 10 mm). The opening in the rubber grommet of the SmartPort [5] should be maintained as small as possible so as not to compromise the efficiency of containment. Always introduce hoses from the outside inwards and apply only little force. Make sure that the seal is seated correctly! The SmartPort is intended for single use and may not be reused.

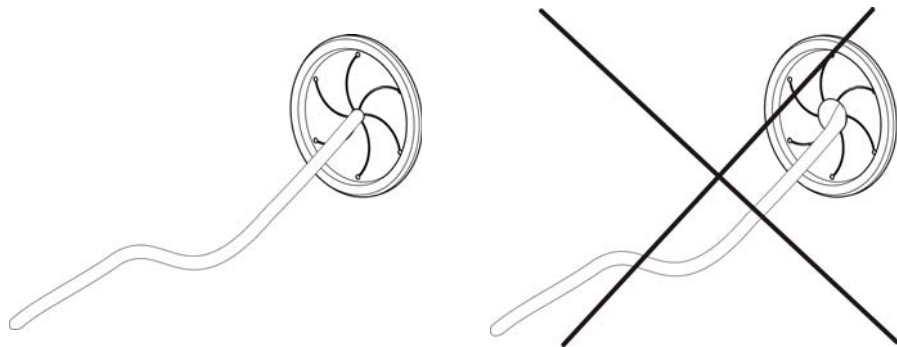

Models with NF label!

Any deviation from the installation instructions for low-voltage cables or tubing through the access port constitutes a non-compliant use of the NF. Such action will, in the event of an accident with biohazardous materials, result in the complete loss of the manufacturer's liability. For the warranty conditions, please see section 1.4 and 1.5 Standards and safety regulations.



Containment!

If feedthrough seals previously pierced are not used in operation, new seals must be installed in order to ensure a stable vacuum in the workspace. The correct seating of the SmartPorts in the side walls must be verified.

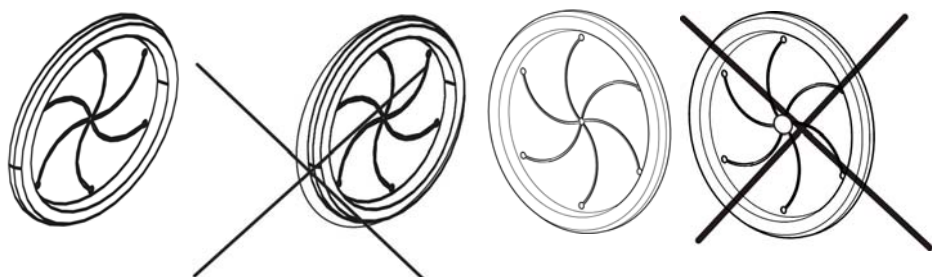

Start-up

Initial operation

Prior to initial operation, the safety cabinet must be subjected to an installation test. Correct assembly and installation performed by the operator are essential for good start-up.

Installing unit and accessories

Version HERAsafe 2030i:

Device without stand:

- Place the device without stand onto a sufficiently stable substructure so that the weight of the device frame does not rest upon the drain pan.
- Remove the protective foil from the table tops and arm rests.

Device with stand:

To assemble the (optional) stand and to install the device frame to the stand:

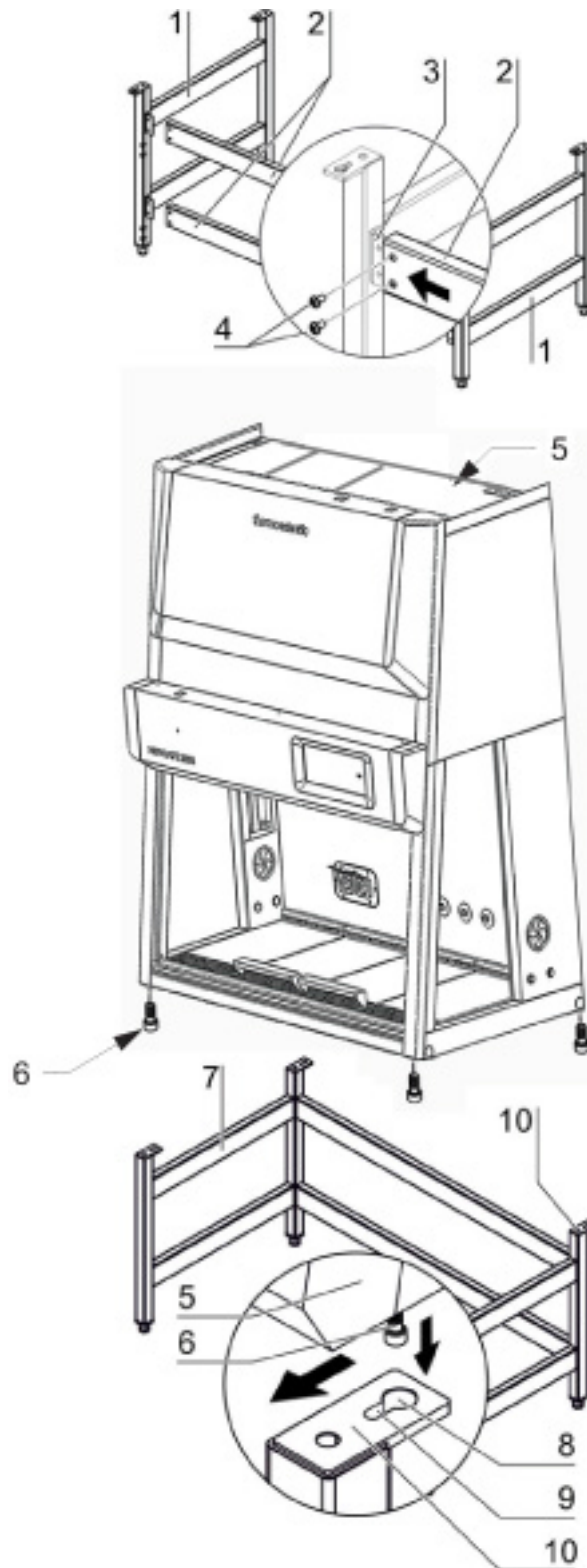

Figure 12 Stand installation

1. Slide the two crossmembers [2] onto the retaining angles [3] of the sidemembers [1]. Secure the crossmembers to the two sidemembers using the screws [4].

2. To attach the device frame [5] to the stand [7], install four Allen screws [6] loosely into the corresponding threaded holes at the underside of the device.
3. Place the safety cabinet [1] onto the stand so that the Allen screws [6] pass through the corresponding holes [8] of the retaining tabs [10].
4. Push the device frame [5] in the grooves [9] of the retaining tabs [10] all the way to the stop.
5. Tighten the four Allen screws [6].

Leveling the device

The cabinet should be levelled only after it has been positioned.

1. Remove transport protection (foil) from the workplate or from the workplate segments.
2. Lift the workplate or the workplate segments and place it/them onto the front and rear rails in the sample chamber with the wide line of holes facing forward.
3. Device without stand: Place a bubble level onto the workplate and align the substructure until the bubble level indicates an exactly horizontal position in all directions.
4. Device with a stand: Place a bubble level onto the workplate and use the four levellers to effect a level state in all planes.
When adjusting the device stand height, proceed from right to left and from rear to front.

Power supply connection



High voltage!

Contact with current-carrying components may cause a lethal electric shock.

Before connecting the device to the power supply system, check plug and power supply cable for possible damage. Do not use damaged components to connect the device to the power supply system!

The connection has to be carried out according to country specific standards.

Establishing the power supply connection:

1. Before connecting the device to the power supply system, check to see if the voltage of the outlet corresponds with the specifications on the nameplate of the device. If the ratings given for voltage (V) and maximum current (A) are not correct, the device must not be connected to the power supply system.
2. Connect the grounding plug of the device to a properly grounded and fused outlet.
 - The outlet must be fused separately using a fusible link T 16 A or using a circuit breaker B 16.
3. Make sure that the power supply line is not subjected to tensile or compressive force.

Installation of the power supply connection:

To protect against accidental switch-off, the outlets for the connection to the power supply must be located outside the normal hand reaching range and must be accessible only to authorized personnel. Ideally, the outlets should be installed above the safety cabinet and be readily accessible. Route the power cables so they do not run across hot surfaces (such as exhaust tubing or similar tubing runs).

Connecting the equipotential bonding:

If the sample chamber is supplied with media (gas, water, etc.), the on-site equipotential bonding must be connected to one of the premounted threaded bushings either at the top of the housing or at the stand.

Initialization routine:

After the unit has been connected to the power supply system, the device control runs through a start-up initialization routine.

Initial Setup

This section explains how to set up the device using the initial setup routine.

When the unit is turned on for the first time after delivery to the customer site, you must complete an initial setup process before you can use the unit. There are five single screens with initial adjustments you must make and confirm using the Next button to complete the full setup.

On some screens, you may return to the previous screen by tapping the Back button. At the top of each screen a step counter shows your progress through the setup routine, indicating the number of the current step and the total number of steps, for example “Step 2 of 5”. A screen title appears directly underneath the step counter to indicate where you are in the setup routine.

Proceed as follows to start up the unit:

1. Power up the device by connecting the external power source.

A startup screen with a Start Setup button appears, prompting you to run the setup, as shown in Figure 13 below.



Figure 13. Initial Startup: Startup Screen

2. Tap the Start Setup button.

The Language Selection screen appears with a wheel picker, prompting you to choose a display language, as shown in Figure 14 below.



Figure 14. Initial Setup: Setting the Language

3. Tap the up/down arrows or swipe your finger across the wheel up or down to set the language (default is English).
4. Once you have chosen your display language, tap the Next button.

The Date Setup screen appears with a wheel picker, prompting you to set the date, as shown in Figure 15 below.



Figure 15. Initial Setup: Setting the Date

5. Tap the *MM/DD/YYYY*, *DD/MM/YYYY*, or *YYYY/MM/DD* radio button on the left side of the screen to choose a date format.

The segments of the wheel picker screen are rearranged to reflect the selected date format. For example, if you select the *DD/MM/YYYY* radio button, the wheel picker will change to 01 | Jan | 2016.

6. Tap the up/down arrows or swipe your finger across the wheel up or down to set the current month, day, and year on each of the three wheel picker segments.
7. Once you have set the date, tap the Next button.

The Time Setup screen appears with a three-segmented wheel picker, prompting you to set the time of day, as shown in Figure 16 below.

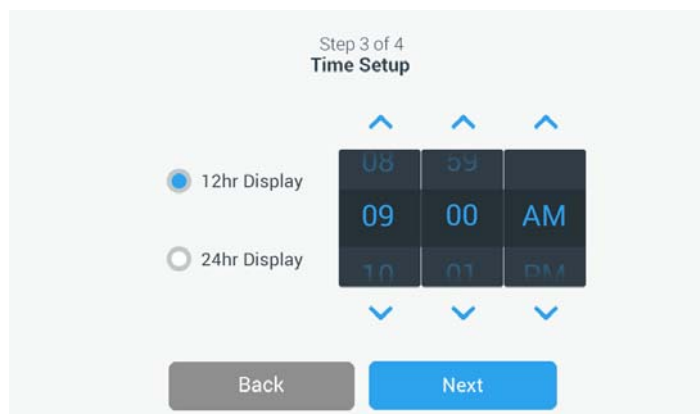

Figure 16. Initial Setup: Setting the Time of Day in 12hr, AM/PM Format

8. If desired, tap the 24hr Display radio button on the left side of the screen to choose the 24-hour time format. (Default time format is AM/PM, 12-hour format.)

The segments of the wheel picker screen are rearranged to reflect the 24-hour time format, as shown in Figure 17 below.

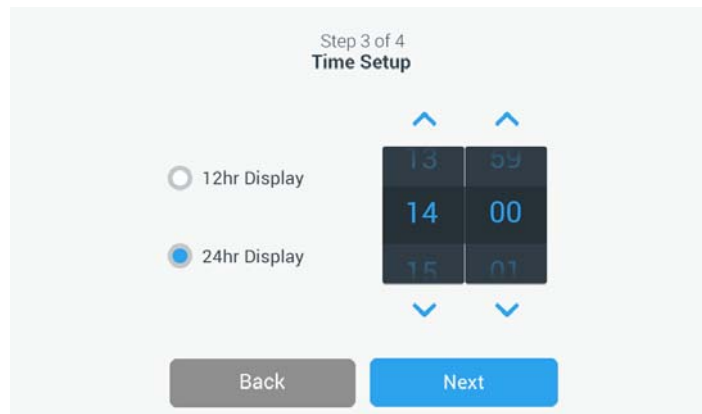

Figure 17. Initial Setup: Setting the Time of Day in 24hr CET Format

9. Tap the up/down arrows or swipe your finger across each wheel up or down to set the current time in hours and minutes.
10. Once you have set the time, tap the Next button.

The Complete Setup screen appears with its Finish button highlighted, prompting you to complete the setup, as shown in Figure 18 below.

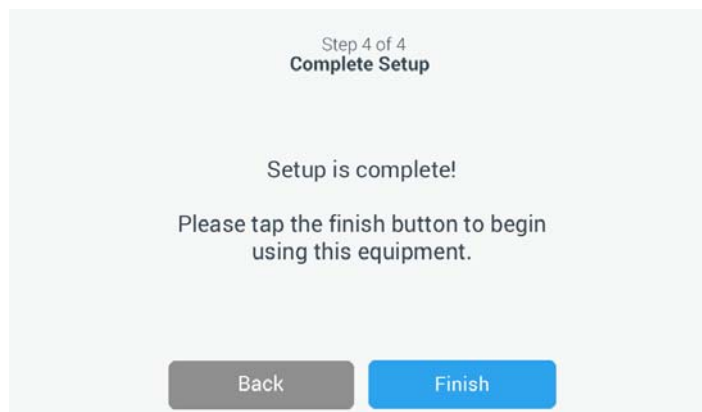

Figure 18. Initial Setup: Completing the Initial Setup

11. Tap the Finish button to have your setup stored.

The unit comes up in idle state, as shown in Figure 19, with the window closed.



Figure 19. Main Screen - Unit in Idle State, Window Closed

The Setup is complete now. You can now begin using the unit.

NOTE All of the settings made in the previous steps can be edited by tapping the settings icon in the left-hand Main Navigation Bar. See “Main Navigation Bar (Region R3)” on page 45.

Power supply connection

The safety cabinet should remain connected to the power supply system at all times to ensure that settings for the individual unit configuration remain active in the memory. If the power supply is interrupted for more than 5 minutes, the time must be reset correctly. After the power supply connection has been reestablished, the system switches to the operating mode that had been active last. Additionally, a window with the message „Mains voltage has been restored“ appears as soon as power has been restored, prompting the user to confirm by tapping OK. This message may, for example, be caused by a power outage.

USB interface

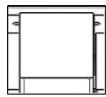

Figure 20 USB interface

The USB port on top of the device is reserved for servicing!



Pin	Name	Description	Level
1	USB_H1_VBUS	Power supply	+5 V DC max 500mA
2	USB_H1_DN	Data minus (D-)	
3	USB_H1_DP	Data plus (D+)	
4	GND	Ground	

Figure 21 USB interface display

The USB port next to the display window enables the user to save log data and install new software releases.

Installation test

Do not operate the device before the installation test has been completed.

- The installation inspection of the device must be conducted in accordance with EN 12469. The cabinet may be operated as a Class II microbiological safety cabinet, in accordance with EN 12469 / 2000, if the device functions or function patterns listed below were checked and if the test results are within the safety value tolerances specified by the manufacturer:
 - Electrical safety test

- Inflow velocity test
 - Downflow velocity test
 - Leakage test of HEPA filters
 - Airflow control test
- A repeat test must also be performed after repairs to the device or after considerable changes (more than 5 cm) to the location of the device.
 - The operator must prepare a test report or request a written test report from the authorized test service.

NOTE Safety warranty

The operational safety of the device, particularly the personal and material protection, are guaranteed only if all safety functions of the device have been tested and approved.

Thermo Electron LED will not warrant the operational safety if the device is operated without performance of the required installation test or if the installation test and repeat test are not performed by adequately trained and authorized personnel!

NOTE Device hygiene

The initial start-up with subsequent installation test does not include any decontamination measures. For operation in the work process, the sample chamber of the device and the accessories required for the work process must be disinfected and cleaned in accordance with the hygiene guidelines set forth for the application.

Operation

This chapter describes how to control the HERAsafe 2030i Biological Safety Cabinet from the touchscreen display mounted in the light dome of the unit.

The screen display unit measures 17.8 cm (7 inches) diagonally across and has touch-sensitive areas that support finger gestures like tapping, swiping and pinching. It can be used with gloves.

Screen Layout

The touchscreen display unit of the HERAsafe 2030i Biological Safety Cabinet is subdivided into the four main screen regions. Figure 22 presents the arrangement of the screen areas discussed in the following.



Figure 22 Screen Areas

The four screen areas offer the following features:

- The Info & Health Status area (Region 1 in Figure 22 above) shows the Biological Safety Cabinet's name, the current date and time, the unit's overall health status, and a login area when password protection is activated. For an overview, see "Info & Health Status Area" on page 40.
- The Main Screen (Region 2 in Figure 22 above) displays the main operating parameters of the unit, including window status and airflow velocities. When alarms or reportable events occur, this part of the display screen shows alarm or event information. For an overview, see "Main Screen (Region R2)" on page 40.
- The Control Panel (Region 2B in Figure 22 above) offers touch-sensitive buttons for controlling the major functions of the unit, such as window up/down, sample chamber illumination, gas supply, and power receptacles. For an overview, see "Control Panel (Region R2B)" on page 43.
- The Main Navigation Bar (Region R3) holds iconic shortcuts to settings screens and is visible at all times. Clicking any of these icons displays settings screen in the Main Screen area. For an overview, see "Main Navigation Bar (Region R3)" on page 45.

Info & Health Status Area

The Info & Health Status Area at the top of the display window appears in all screen displays. Figure 23 shows an example of the Info & Health Status Area on a unit that is in a proper working condition.



Figure 23 Info & Health Status Area

The Info & Health Status Area displays the following information:

- Unit Name (top left in Figure 23), as entered during the initial setup (see “Initial Setup” on page 33)
- Date/Time (bottom left in Figure 23), as entered during the initial setup (see “Initial Setup” on page 33) or adjusted later on (see “Setting the Date” on page 84 and “Setting the Time of Day” on page 84).
- The Unit Health Status icon (center in Figure 23) is a touch-sensitive area that opens a Health Status pop-up window on top of the Main Screen. Four different icons may appear in this place, representing the overall health status of the Biological Safety Cabinet:



The green Health Status Good icon indicates that the unit is in proper operating condition. For more details, see “Viewing General Status Information” on page 66.



The yellow warning triangle is a Health Status Warning icon. It indicates that there is an issue that does not stop operation of the Biological Safety Cabinet immediately, yet requires the operator’s attention soon, such as a HEPA filter to be replaced. For more details, see “Handling Alerts” on page 65.



The „red bell“ Health Status Alarm icon indicates that there are one or more major alarm conditions that need to be corrected because they may constitute a hazard to the operator or the unit itself. The blue circle indicates how many alarms exist.



A red bell with sound waves on both sides (top) means that the alarm is sounding, while the red bell with the diagonal line across (bottom) shows that the alarm has been snoozed. For more details, see “Silencing and Handling Alarms” on page 62.

- The Login prompt (top right in Figure 23) appears only if the unit is set up to operate in Secure Mode (see “Access Control” on page 88).

Main Screen (Region R2)

The Main Screen takes up the main part of the display settings screen and displays the status details on the Biological Safety Cabinet.

Figure 24 shows the unit in working mode, with the Window ready in the working position and the downflow and inflow velocities at operational speeds. The sample space illumination, blowers, gas supply and power receptacle functions are all on.



Figure 24 Main Screen

The screen content changes with operational state, depending on whether the unit is:

- in working mode, as shown in Figure 24 above
- starting up, as explained in “Startup Mode” on page 46
- in standby mode, as explained in “Standby Mode” on page 47
- ready for loading and/or cleaning, as explained in “Cleaning and Loading Mode” on page 47
- in idle state, as explained in “Idle Mode” on page 48
- running UV disinfection, as explained in “Running UV Disinfection” on page 54

The side-view symbol graphic on the left shows the current state of the unit. Figure 25 gives an overview of how the symbol graphic varies with different operational states.



Window closed



Window open



UV disinfection running, window closed and purple orb in the sample chamber



Ready for cleaning or loading (HERAsafe 2030i), front window hinged

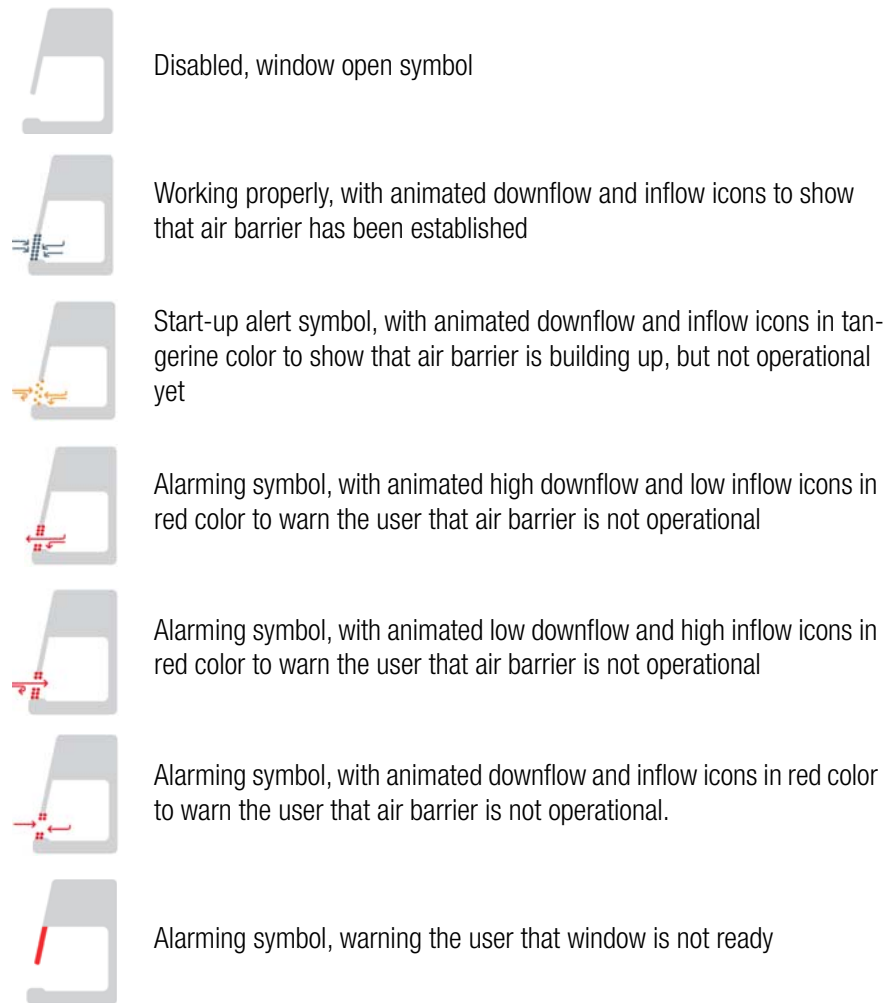

Figure 25 Overview of Side-View Symbol Graphics for Unit Status

Three status indicator boxes appear in the center of the Main Screen. They show, from top to bottom, the state of the window, plus the downflow and inflow statuses.

Status indicator boxes may display with four different status icons:



The checkmark on the green circle indicates that this particular function is working properly.



The yellow animated timer icon indicates that the unit is working up towards an operational state.



The white cross on the red circle indicates that there is a problem with that particular function.



The light gray dash on the gray circle signifies there is no activity. This icon indicates, for example, that there is no airflow when the unit is on, but the blowers are off.

The following examples show different combinations of status indicator boxes for major operational states.

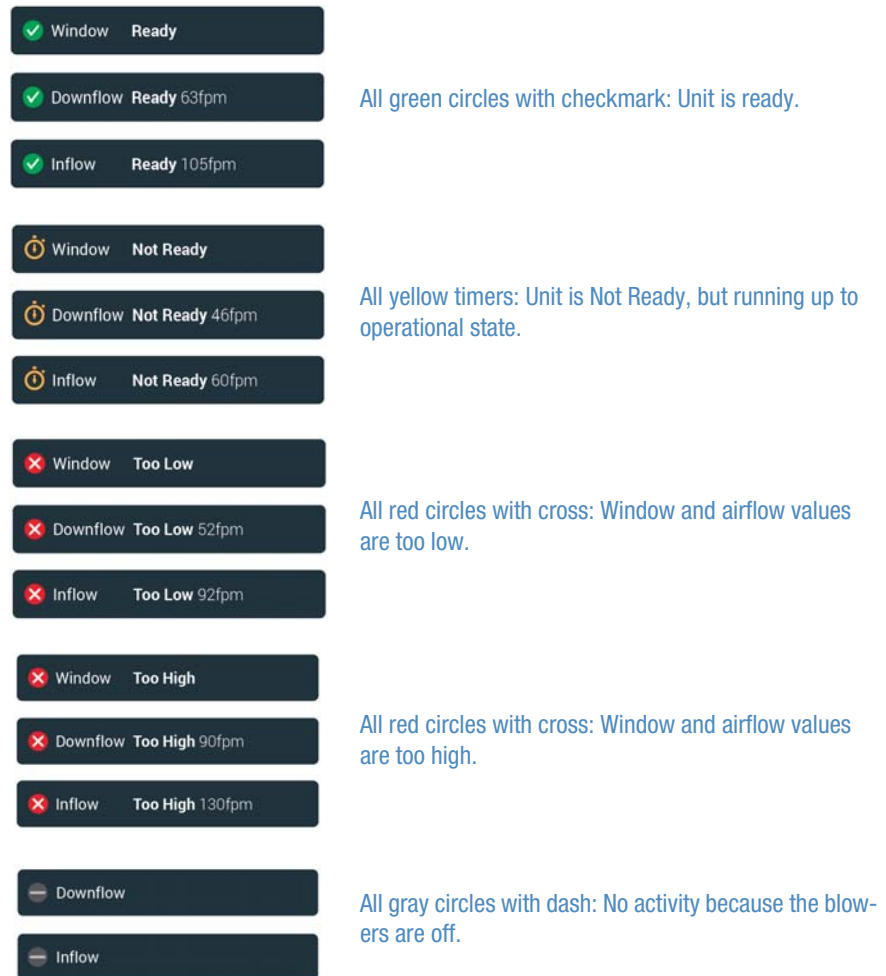

Examples for windows with different operational states are shown below.

Control Panel (Region R2B)

The Control Panel in Screen Region R2B contains a complete set of controls for operating the functions of the Biological Safety Cabinet. The inventory of buttons varies with the number of options built into the unit, as can be seen in Figure 26 and Figure 27.

The Control Panel is visible at all times below the Main Screen.

Figure 26 shows the Control Panel for a Biological Safety Cabinet equipped with all options, including a motorized window, sample chamber illumination, sample chamber blowers, gas supply and a power receptacle in the sample chamber.

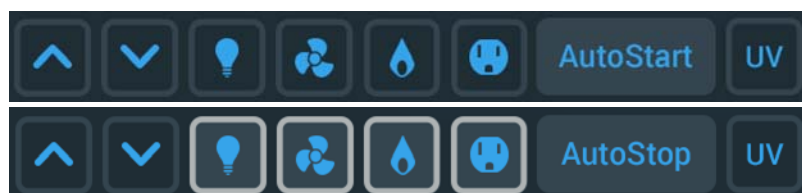

Figure 26 Control Panel for Fully Equipped Unit

Functions that are currently working are identified by a light gray frame around the button, as shown in the bottom rows of Figure 26 and Figure 27. A frame dimmed to dark gray, as shown in the top rows, indicates that the function is available, but currently not in use.

Figure 27 shows the Control Panel for a unit equipped with all options but the gas supply.

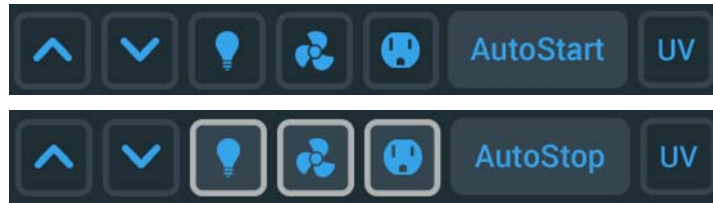

Figure 27 Control Panel for Unit without Gas Option

The functions of the individual control panel buttons are explained in Figure 28 below.



The **Window Open and Window Close buttons** (available on units with a motorized window) labeled with up and down arrows raise and lower the window.



The Light Bulb button switches the interior sample chamber illumination of the Biological Safety Cabinet on and off.



The Fan button switches the interior sample chamber blowers of the Biological Safety Cabinet on and off. During the UV disinfection cycle, the blowers run in reduced flow mode, which is indicated by a small blue circle labeled „1/2“ (see lower image on the left side). The fans also run in reduced flow mode when the front window is closed and there is no UV disinfection ongoing.



On units equipped with the gas option, the Gas button opens or closes the valve that controls the gas supply to the sample chamber. If the window is open to working position, and the blowers are running and airflow speed is ok, you may tap the gas button to open the gas valve. In any other condition, the gas button will not open the gas valve and a pop-up message appears stating:
The gas valve can only be opened when the window is in the working position, the fans are running, and there are no active alarms. The gas button is deactivated automatically if the user shuts the window, turns the blowers off, or if an alarm is triggered.



The Power Receptacle button switches the power receptacles in the sample chamber of the Biological Safety Cabinet on and off.



The Autostart button starts the unit immediately with the set of functions previously selected in the Autostart settings (see “Programs” on page 76).



The Autostop button stops the unit immediately, closing the window and leaving only a user-selected set of functions enabled, as previously selected in the Autostart settings (see “Programs” on page 76).



The UV button switches UV disinfection of the sample chamber on and off.

Figure 28 Buttons on the Control Panel

When operating the Window Close and AutoStop buttons, you must tap and hold the button until the window is closed. This is a safety feature.

To aid users in this gesture, the tooltip-style bubble shown in Figure 29 is displayed on screen when you press either button.

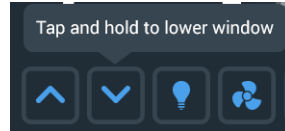

Figure 29 Tooltip Bubble over Window Close Button

Main Navigation Bar (Region R3)

The Main Navigation Bar (in Screen Region R3) holds icons for all major settings of the HERAsafe 2030i Biological Safety Cabinet.

The Main Navigation Bar is visible at all times on all screens.

Icon	Meaning
	Back button: cycles through all screens previously displayed (grayed out if on Main Screen).
	Home icon: Returns to the Main Screen.
	Settings icon: Opens the Settings screen (see “Settings” on page 68) with various options for parameter settings.
	Event Log icon: (see “Event Log” on page 90)
	Alarm Settings icon ¹ : Opens the Alarms and Alerts Settings screen (see “Alarms and Alerts Settings” on page 70).
	Data Plate icon ¹ : Opens the Data Plate screen (see “Data Plate” on page 86) showing general data about the unit.
	Programs icon ¹ : Opens the Programs screen (see “Programs” on page 76), where you can program the AutoStart and AutoStop functions.

¹ can also be accessed from the Settings screen

Figure 30 Main Navigation Bar

Working Mode

Figure 31 shows the Main Screen in working mode.



Figure 31 Main Screen - Unit Working

The side-view symbol graphic shows that the window is opened to working position, and the arrows in the animated air barrier icon show that the air barrier is working properly. The three status indicator boxes to the right of the symbol graphic show green checkmarks to indicate that the window is at the correct position, and that downflow and inflow velocity are at their correct values.

Buttons are highlighted in the Control Panel Area to indicate that the sample chamber illumination, blowers, gas supply, and power receptacle functions are all on, as needed for a working session. The AutoStop button is available because the unit is running.

Startup Mode

Figure 32 shows the Main Screen while the unit is starting up. The following startup screen shows what happens when the AutoStart or Fan button is tapped: The screen shows alerts for the air barrier because the airflow velocities are not up to speed yet.



Figure 32 Main Screen - Unit Starting Up

The symbol graph shows that the window is opened to the working position, and the animated yellow arrow and air barrier symbols indicate that the airflow is not ready. The three status indicator boxes show:

- a green checkmark icon in the window status box to indicate that the window is ready, but
- yellow timer icons with rotating hands show in the Downflow and Inflow boxes, signifying that the airflows are not up to proper speed yet.

NOTE When the operational downflow and inflow velocities are reached, the yellow timers are replaced by green checkmark icons.

Figure 32 shows a typical startup mode example for AutoStart, with the lights, fans, and power receptacle buttons already enabled (see “Programs” on page 76 for more details). If enabled in AutoStart, the gas button may come on later when the airflows are up to speed.

Standby Mode

Figure 33 shows the Main Screen in standby mode.



Figure 33 Main Screen - Unit in Standby

Standby mode is entered when you close the window from within a working session, which is indicated by the closed window in the side-view symbol graphic. A Standby header appears to the right of the graphic, showing the unit is in standby mode, maintaining cleanliness and containment, and ready to resume work when you move the window back to the working position. The green checkmark next to the Standby header signifies that everything is working properly.

In the Control Panel Area, buttons are highlighted to indicate that functions are still on, including the sample chamber illumination, the blowers, and the power receptacles. The AutoStop button is also available because the unit is running.

If the window is closed, the blowers will switch to reduced flow, as indicated by the small blue circle with the „1/2“ label .

Cleaning and Loading Mode

Cleaning mode is entered when you fully open the front window using the hinge for accessing the sample chamber, for example, in order to decontaminate or introduce larger accessories. Cleaning mode is indicated by the flipped-up window in the side-view symbol graphic and the Cleaning Mode header that appears next to it, as shown in Figure 34.

Additional text like SmartClean Plus and Sample chamber open for cleaning and/or loading or unloading further explains what cleaning mode is for.

The Health Status Icon in the Info & Health Status Area is a yellow warning triangle.



Figure 34 Main Screen - Unit Cleaning

All functions in the Control Panel Area (lights, blowers, gas, receptacle, UV) are off. The AutoStart button is available as the unit is not running.

Idle Mode

Idle mode is entered when you turn all functions (including the fans) off, with the window either in the working position or closed. Idle mode is indicated by the gray „no activity“ icons in the downflow and inflow status indicator boxes, as shown in Figure 35.



Figure 35 Main Screen - Unit in Idle State, Window Closed

Idle mode is also possible with the window opened to the working position, as shown in Figure 36. In this case, the downflow and inflow status indicator boxes show an alert icon.



Figure 36 Main Screen - Unit in Idle State, Window Open

Handling and Control

The following section describes basic, everyday operations you need for working with the device:

Using the Auxiliary Rocker Switch

The basic functions required for the operation of the device can be controlled using the auxiliary rocker switch:

- raising and lowering the front window during a mains power failure.

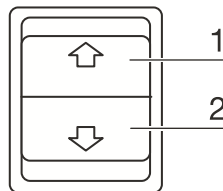

Figure 37 Basic Functions of the Auxiliary Rocker Switch

Moving the Front Window

The movement of the front window is controlled by depressing the auxiliary rocker switch control element with the corresponding arrow symbol.



Crushing hazard

During movement of the front window do not try to access the inner chamber.

To raise the window, proceed as follows:

1. Press the control element [1/Figure 37].

When the front window reaches the working position, the movement stops automatically. If the movement starts above the working position, the front window stops at the maximal opening position.

2. To stop the upward movement, release the control element.
3. To lower the window, keep the control element depressed [2/Figure 37].
4. To stop the downward movement, release the control element.

When the front window reaches its working position, the movement stops automatically, the audible alarm signal is switched off, and the green Health Status Good icon  appears in the Info & Health Status Area at the top of the display settings screen.

When the front window does not reach the working position, the Health Status Alarm icon  appears in the Info & Health Status Area at the top of the display screen, along with a scrolling alarm description. For details on how to handle alarms, please refer to the section “Silencing and Handling Alarms” on page 62.

The audible alarm signal is switched off when the front window is completely closed.

Moving the Front Window to the Working Position



Crushing hazard

During movement of the front window do not try to access the inner chamber.

To move the front window up to the working position, proceed as follows:

1. Tap the Window Open button  on the Control panel to raise the window from the closed to the working position.

When the front window reaches the working position, the movement stops automatically. When the movement starts above the working position, the front window stops at the maximal opening position.

NOTE The working position is factory pre-set and cannot be changed in the Settings.

To stop the upward movement, proceed as follows:

2. Tap the Window Close button .

To continue the upward movement beyond the working position, proceed as follows:

3. Tap the Window Open button .

Lowering the Front Window

To lower the front window, proceed as follows:

1. Tap the Window Close button  on the Control panel and keep it depressed until the window reaches its closed position.

To stop the downward movement, proceed as follows:

2. Release the Window Close button .

Switching the Sample Chamber Illumination On and Off

In each operating mode but the UV disinfection cycle, the sample chamber illumination can be switched on or off.

To switch the illumination on or off, proceed as follows:

1. Tap the Light Bulb button  to switch on or off.

The illumination comes on, and the Light Bulb button  is displayed with a light gray border.

Activating and Deactivating the Internal Power Supply Receptacles

All power outlets in the sample chamber can be activated (power supply on) or deactivated (power supply off) simultaneously.

To activate the power receptacles, proceed as follows:

1. Tap the Power Receptacle  button.

The powered accessories in the sample chamber are turned on, and the Power Receptacle button  is displayed with a light gray border.

To deactivate the power supply receptacles, proceed as follows:

2. Tap the Power Receptacle  button.

The powered accessories in the sample chamber are turned off, and the light gray border on the Power Receptacle button  disappears.

Activating and Deactivating the Internal Gas Supply

The solenoid valve controlling the gas inflow can be opened and closed from the Control Panel.

To activate the gas inflow, proceed as follows:

1. Tap the Gas  button.

Gas starts streaming through media valves within the sample chamber, and the Gas button  is displayed with a light gray border.

To deactivate the power supply receptacle, proceed as follows:

2. Tap the Gas  button.

The solenoid valve gives a clicking sound, the gas supply to the sample chamber is turned off, and the light gray border on the Gas  button disappears.

Logging into a Passcode-Protected Unit

In laboratory environments with exacting biosafety requirements, there may be a need to restrict access to the Biological Safety Cabinet.

This enhanced level of biosafety is afforded by Secure Mode.

NOTE Secure Mode can only be enabled by an administrator. The process of enabling Secure Mode is described in the section “Access Control” on page 88.

If the unit is in Secure Mode, the word Login appears in the top right corner of the Info & Health Status Area, as shown in Figure 38 below.



Figure 38 Info & Health Status Area with Login Prompt

As a regular user, your login is not time-limited, that is, the session will never time out.

When you tap Login, a login box appears in the center of the screen, then slides up while a keyboard slides in from the bottom.

NOTE If the unit is set to Open mode, the word Login will not be displayed in the top right corner of the screen. Some specialized functions require that you log in, though. For example, when you tap the Factory Settings or Field Certification buttons in the Settings screen (see “Settings” on page 68) you will be prompted to log in.

Logging In

To log into a unit in Secure Mode, proceed as follows:

1. Tap the word Login in the top right corner of the screen, or tap anywhere else on the screen.

The Login window appears on top of the screen, then a keypad slides up from the bottom and pushes the Login window up towards the top of the screen (see Figure 39).

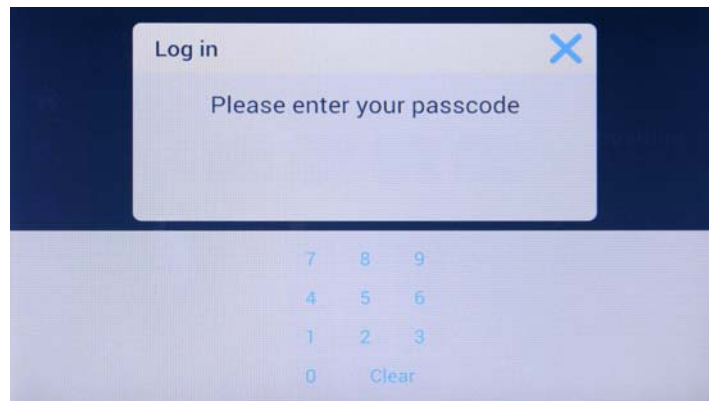

Figure 39 Login Window

2. Enter your four-digit passcode, or tap the X icon to exit and close the window if you do not want to log in.

After entering the last digit, you will be logged in. The Main Screen appears, with the word Logout (instead of Login) in the top right corner.

NOTE If you have entered an incorrect passcode, an error message appears below the passcode field. Try again using the correct passcode.

Logging Out

1. Tap the word Logout in the top right corner of the screen.

The Log Out window shown in Figure 40 appears on top of the screen, asking you to confirm that you want to log out.

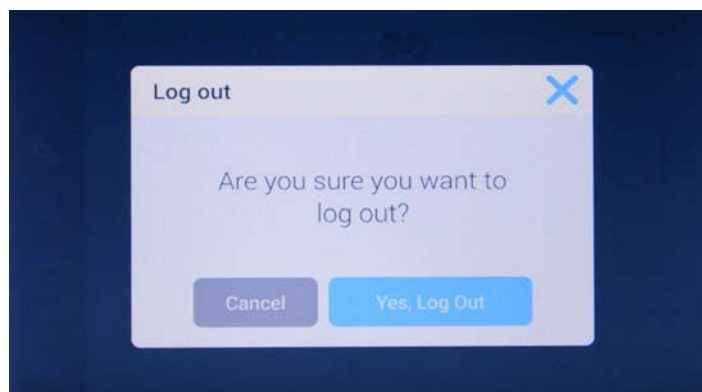

Figure 40 Log Out Window

2. Tap the Yes, Log Out button to confirm, or tap the No button or X icon in the top right corner to exit and close the window if you do not want to log out.

The confirmation message appears shown in Figure 41, confirming that you have been logged out successfully.

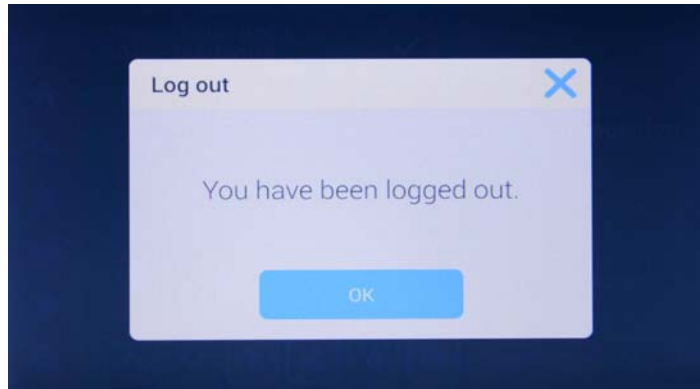

Figure 41 Log Out Screen: Logged Out Message

You will be returned to the main home screen, regardless of the screen you were viewing before you decided to log out. In Secure Mode, the unit also automatically shuts off all functions that were previously on, such as illumination, blowers, power receptacles, gas. You may still raise or lower the window on the unit.

Running UV Disinfection

The Biological Safety Cabinet has a built-in UV disinfection routine that affords an intensifying additional disinfection after a standard wipe/spray disinfection. UV disinfection can be started by pressing the UV button on the Control Panel.

For running the UV disinfection routine, the front window must be completely lowered to protect against UV radiation. A safety interlock ensures that the routine cannot be run until the front window is in the closed position.

While the routine is running, the UV Disinfection screen shown in Figure 42 below is displayed on the Main Screen.



Figure 42 Main Screen: UV Disinfection Running

The UV Disinfection Screen sports the side-view symbol graphic with the window closed and a purple orb in the sample chamber. To the right of the graphic a green checkmark and the UV Disinfection header identifies the current mode of operation.

Additionally, the Total cycle time in hours and the time remaining in hours, minutes and seconds are displayed.

UV disinfection ends when the preset total cycle time for the routine has elapsed. Then, the UV lamps are switched off automatically, and the UV Disinfection screen goes away.

If the setting for UV Disinfection (see “Setting UV Disinfection Cycle Time” on page 69 for instructions) includes an adjustment for bulb life, the label for the total cycle time display reads Total adjusted cycle time, as shown in the example in Figure 43.



Figure 43 Main Screen: Disinfection Running with Adjustment for Bulbs

Tapping the Total cycle time: n hr label will take you to the Disinfection Cycle setting screen if you need to change the setting. The process of setting cycle time is described in the section “Setting UV Disinfection Cycle Time” on page 69.

You can also tap the Power Receptacle button  on or off during an ongoing UV Disinfection cycle.

When the Light Bulb button  is tapped, a pop-up window appears, stating The LED light cannot be turned on during the UV disinfection cycle. Would you like to abort the UV cycle and turn the LED lights on?



Figure 44 UV Cycle Alert When Light Bulb Button is Tapped During UV Disinfection

You may then choose to continue by tapping No, or abort UV disinfection by tapping Yes

Starting the UV Disinfection Cycle

Proceed as follows to start the UV Disinfection cycle:

1. Tap the Window Close button  on the Control panel to close the window. Hold the button all the way until the window is closed.

The tooltip-style bubble shown in Figure 45 appears above the button as a reminder that you need to close window completely.

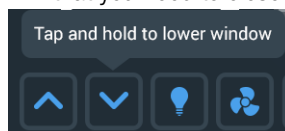



Figure 45 Tooltip Bubble over Window Close Button

- If the UV button  is pressed while the front window is open and/or the sample chamber illumination is on, the following pop-up window will appear.

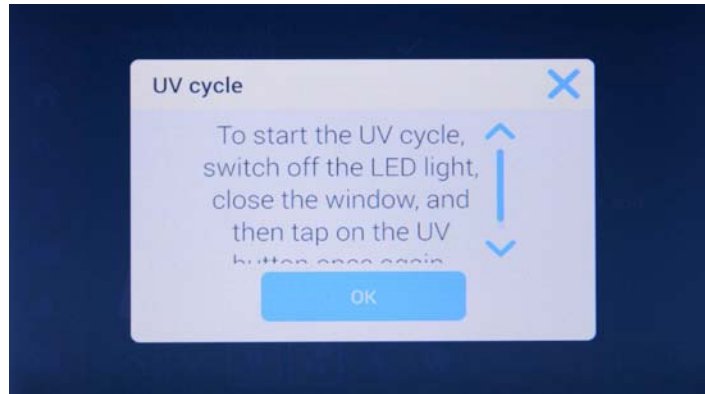





Figure 46 UV Cycle Alert When Window is Open / Illumination is On

- If this happens, tap the OK button to close the pop-up window, then use the Light Bulb button  to turn off the sample chamber illumination and/or the Window Close button  to close the window.
- Tap the UV button  on the Control panel (again) to start the UV Disinfection cycle.

The UV Disinfection screen shown in Figure 42 appears. The sample chamber illumination is off, the blowers are on at reduced speed, the gas supply is off, and the power receptacle is off. The AutoStop button is available as the unit is running. The UV and Fan buttons are highlighted with a light gray frame to indicate that both functions are on. The Fan button is displayed with a „1/2“ label in a small blue circle to indicate that the blowers are running in standby mode.

NOTE If you need to extend or shorten the UV disinfection cycle, you can tap the Total cycle time: n hr label to go the Disinfection Cycle setting screen. The process of setting cycle time is described in the section “Setting UV Disinfection Cycle Time” on page 69.

- Wait until the UV Disinfection cycle is complete.

Completion of the UV disinfection cycle is announced by the alert message shown in Figure 47.

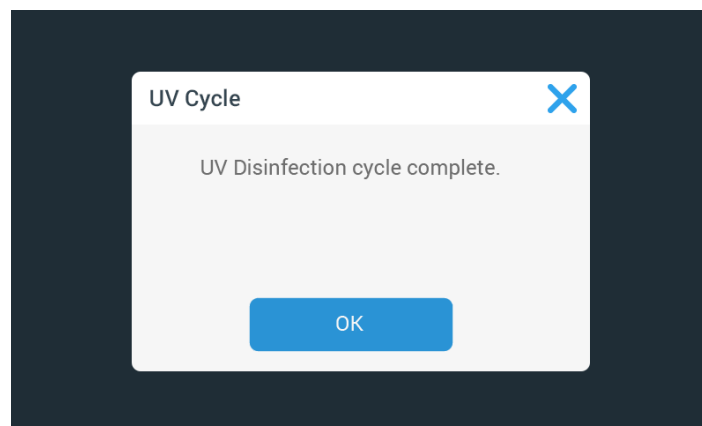

Figure 47 UV Disinfection Cycle Complete Alert

- Tap the OK button to complete the UV disinfection cycle.

Turning the Fan On and Off During UV Disinfection

In UV Disinfection mode, the only other button that can be pressed is the Fan button. When the Fan button is pressed on, the blowers are turned on in Stand-by mode and will remain on until you turn them off.

Proceed as follows to turn the blowers on during a UV disinfection cycle:

1. From within the running UV disinfection cycle, press the Fan button .

If this is the first time you turn the blowers on during the ongoing UV disinfection cycle, the pop-up window shown in Figure 48 will appear, reminding you that the blowers will continue to run in reduced flow mode after the UV disinfection cycle is complete.

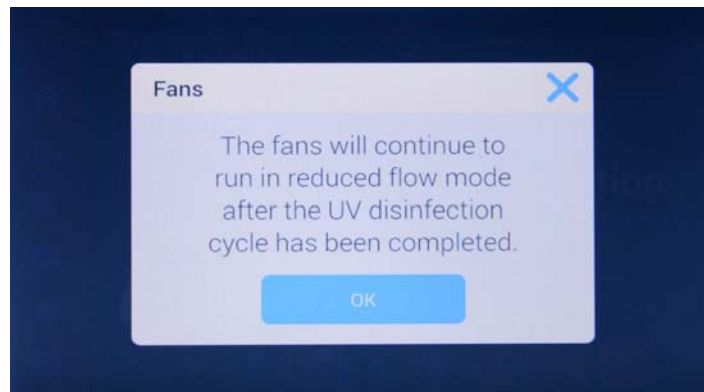

Figure 48 Reduced Flow Mode Alert During UV Disinfection Cycle

The Fan button will change its appearance, displaying a gray border and a small blue circle labeled „1/2“ to indicate that the blowers are running in reduced flow mode (see Figure 49).

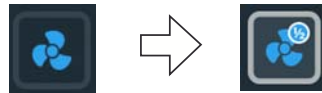

Figure 49 Fan Button in Off Mode vs UV Disinfection Mode

2. Tap the OK button or the X icon in the top right corner to close the window, or wait for the window to close automatically after 10 seconds.

Proceed as follows to stop the blowers while a UV disinfection cycle is running:

1. Tap the Fan button  on the Control panel to stop the blowers.

The pop-up window shown in Figure 50 will appear, stating that the blowers are off now.

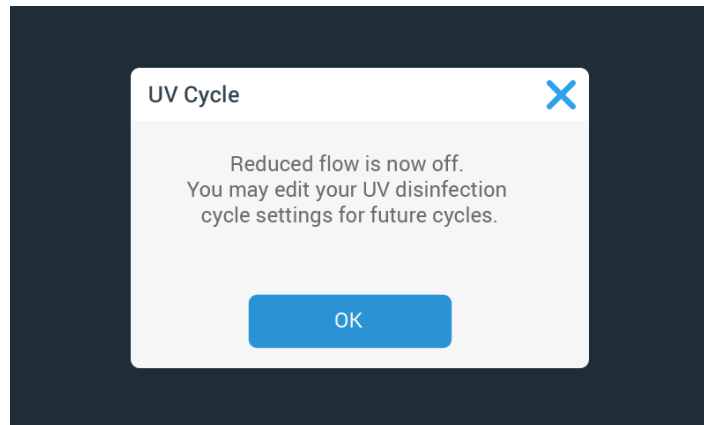

Figure 50 Reduced flow is now off Alert

The Fan button will change its appearance, returning to its „off-state“ image (see Figure 51).

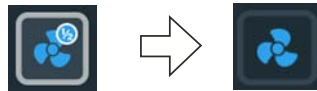

Figure 51 Fan Button in UV Disinfection Mode vs Off State

2. Tap the OK button or the X icon in the top right corner to close the window, or wait for the window to close automatically after 10 seconds.

Restarting a Disrupted UV Disinfection Cycle

If the UV disinfection cycle is disrupted, for example, because the front window has been opened or another error has occurred, a pop-up window appears, stating that the UV Disinfection cycle has been disrupted (see Figure 52 below).



Figure 52 UV Disinfection Cycle was Disrupted Alert

To restart a disrupted UV disinfection cycle, proceed as follows:

1. Correct the problem, for example by closing the window.
2. Tap the Restart UV Cycle button, or tap the Home button to exit.

The UV disinfection cycle will start over.

Alarms

If the downflow, inflow or window parameters are not at operational settings, there may be at risk of exposure to biohazardous material or contamination. In this case, the Biological Safety Cabinet emits a visual and audible alarm to alert the user, as shown in Figure 53 below.

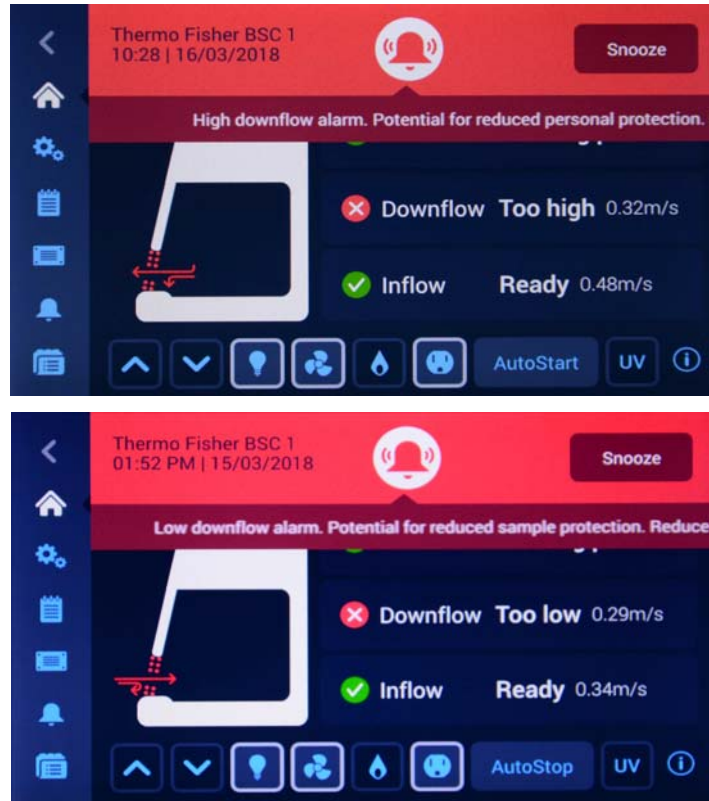

Figure 53 Alarming Screen for Downflow Too High and Too Low Alarm

A health status icon in the shape of an alarm bell appears on a red background, along with a snooze button. Directly below the bell icon, descriptive text explains the issue and provides instructions on how to troubleshoot it. If there is more text than will fit on screen, the text scrolls from right to left in „newsticker fashion“. When multiple alarms occur at the same time, the health status icon has a small blue circle overlay that shows the number of pending alarms, and additional alarm descriptions appear in the newsticker section.

The symbol graphic in the Main Screen appears with a pertinent animation that identifies the type of problem and its location. For example, the air barrier sliced in two by red arrows shown in Figure 53 indicates that there is a downflow problem (see Figure 25 on page 42 for a complete overview of appearances).

Tapping the snooze button silences the audible alarm temporarily for a pre-set timeout period. (The default alarm snooze timeout period is 5 minutes, but the setting may be changed in the Alarm Settings screen, as explained in “Snooze Timeout” on page 73). The alarm bell icon is crossed out to indicate that the audible alarm signal has been snoozed (see Figure 54 on page 61).

NOTE

Applicable BSC standards in effect may not allow temporary muting of audible alarm and limit the available choice of alarm tones.

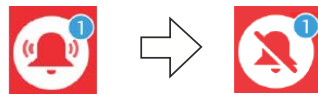

Figure 54 Health Status Alarm Icon („Alarm Bell“) in Unsnoozed and Snoozed Modes

If you tap the red Health Status Alarm icon instead of the Snooze button, the audible alarm is automatically snoozed, but the countdown timer shown in Figure 55 appears immediately next to the snoozed alarm icon to indicate when the audible alarm will return.

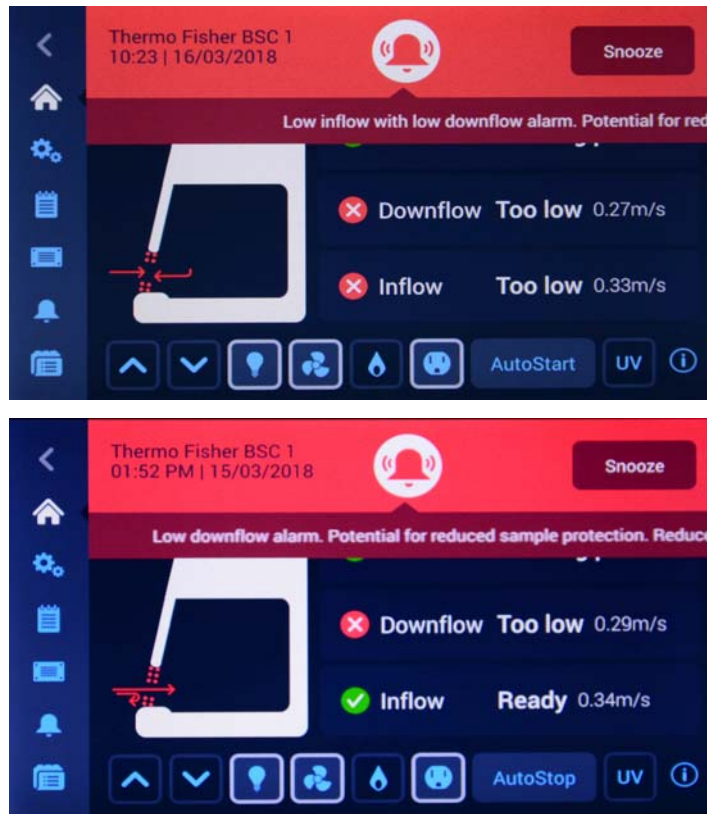

Figure 55 Alarming Screen with Snoozed Alarm

Additionally, you will be taken directly to the Health Status Danger screen with its alarm list shown in Figure 56.

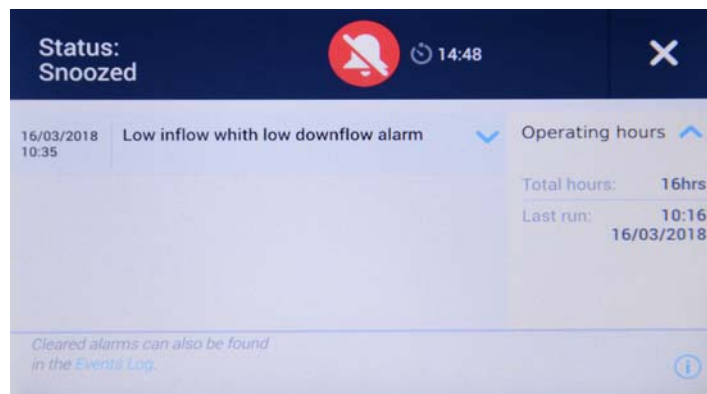

Figure 56 Health Status Alarm Screen

Once the ticker message has been visible for two cycles of displayed text, the screen changes to the appearance shown in Figure 57 below:

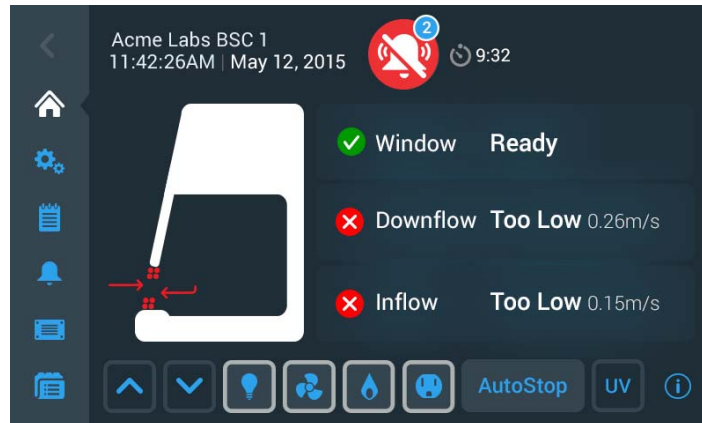



Figure 57 Main Screen After Two Cycles of Alarm Ticker Message

The health status icon has changed to show the audible alarm is snoozed. To the right of the health status icon is a countdown timer showing the snooze time remaining, that is, the time period after which the audible alarm is resumed.

When the issue causing the alarm has been resolved, for example, when the user moves the front window to the appropriate position, the audible and visual alarms automatically disappear, and the screen display returns to the healthy state (see “Viewing General Status Information” on page 66).

Silencing and Handling Alarms

To silence the audible alarm and handle the problem, proceed as follows:

1. When an audible alarm is sounded, go to the Biological Safety Cabinet and tap the Snooze button  to temporarily silence it.
2. Inspect the small blue alarm counter in the red Health Status Alarm icon  to find out whether you have to handle one or more alarms.
3. Read the instructions in the newsticker area to learn more about the issue(s) and available troubleshooting options.

After two cycles of displayed text, the ticker message disappears and is replaced by the Main Screen shown in Figure 57 above.

4. Tap the red Health Status Alarm icon  to display the Health Status Alarm screen shown in Figure 56 and review the alarm list.
5. Correct each issue that has caused an alarm.

As you correct the pending issues, they will disappear from the alarm list on the Health Status Alarm screen one by one.

When the last issue has been cleared, the screen display returns to the healthy state and the green Health Status Good icon  replaces the red Health Status Alarm icon



The alarm volume should be adjusted in the alarm settings screen according to the sound level of the environment lab.

Alerts

Some events in the Biological Safety Cabinet that do not immediately affect containment or cleanliness produce alerts. These alerts appear with the visual features shown in the example in Figure 58.

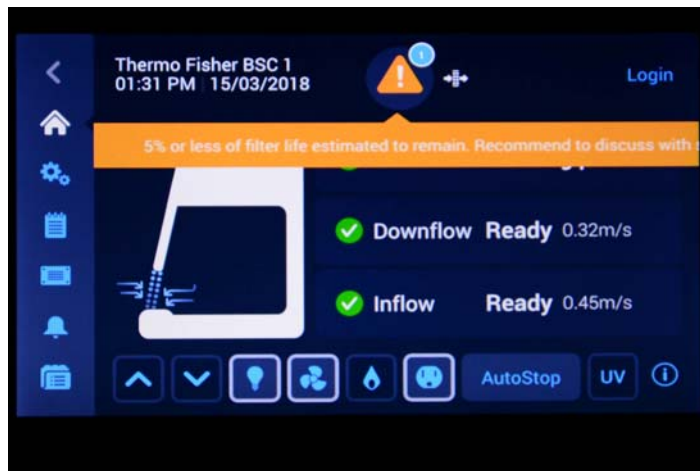

Figure 58 Alert Screen with Filter Replacement Reminder

The Health Status Warning icon in the shape of a yellow warning triangle icon appears on a black background and a short signal sounds. Directly below the warning triangle icon, descriptive text explains the issue and provides instructions on how to correct it. If there is more text than will fit on screen, the text scrolls from right to left in „newsticker fashion“. When multiple alerts occur at the same time, the health status icon has a small blue circle overlay that shows the number of pending alerts, and additional alert descriptions appear in the newsticker section.

The symbol graphic in the Main Screen appears remains unchanged. In the filter message example shown in Figure 58, the air barrier is displayed as fully functional (see Figure 25 on page 42 for a complete overview of appearances).

If you tap the warning triangle icon, you will be taken directly to the Status Warning screen with its alert list, shown in Figure 59.

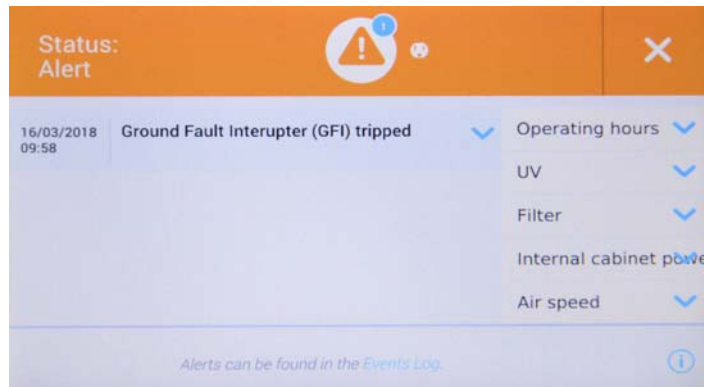

Figure 59 Status Warning Screen with Alert Screen Message, Status Alert GFI

Events that produce alerts include:

- GFI (Ground Fault Interruptor; US versions only) has tripped and switched off the power receptacle
- Filter nearing end of life and needing replacement
- UV light bulb nearing end of life and needing replacement
- Field Certification expiring

Figure 60 Types of Alerts and Their Specific Icons

Each type of alert has a specific icon (see Figure 60 above) that appears both to the right of the Alert icon and in the Status Warning screen.

Once the ticker message has been visible for two cycles of displayed text, the ticker will go away and the screen changes to the appearance shown in Figure 61 below:

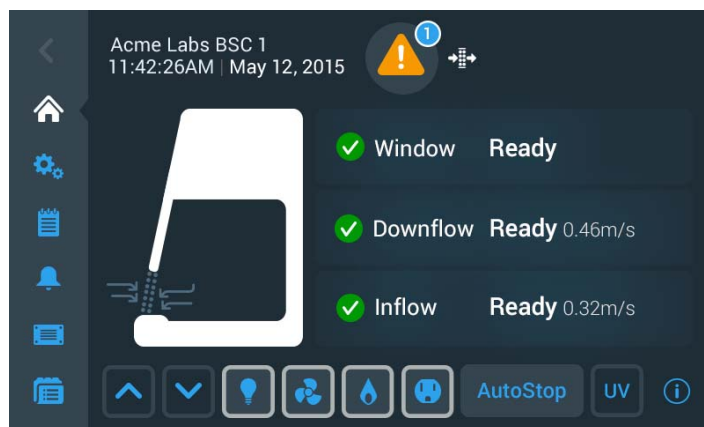

Figure 61 Main Screen After Two Cycles of Alert Ticker Message

When the issue causing the alert has been resolved, for example, when the user has replaced the filter, the alert can be cleared from the status screen, and the screen display returns to the healthy state (see “Viewing General Status Information” on page 66).

Handling Alerts

To handle alerts, proceed as follows:

1. When an alert appears, inspect the small blue alarm counter in the Health Status Warning icon 🚨 to find out whether you have to handle one or more alerts.
2. Read the instructions in the newsticker area to learn more about the alert(s) and available troubleshooting options.

After two cycles of displayed text, the ticker message disappears and is replaced by the Main Screen shown in Figure 61 above.

3. Tap the yellow Health Status Warning icon to display the Status Warning screen shown in Figure 59 and review the alerts list.
4. Tap any entry in the alarm list to view additional details, as in the GFI Tripped (US versions only) example in Figure 62 below.

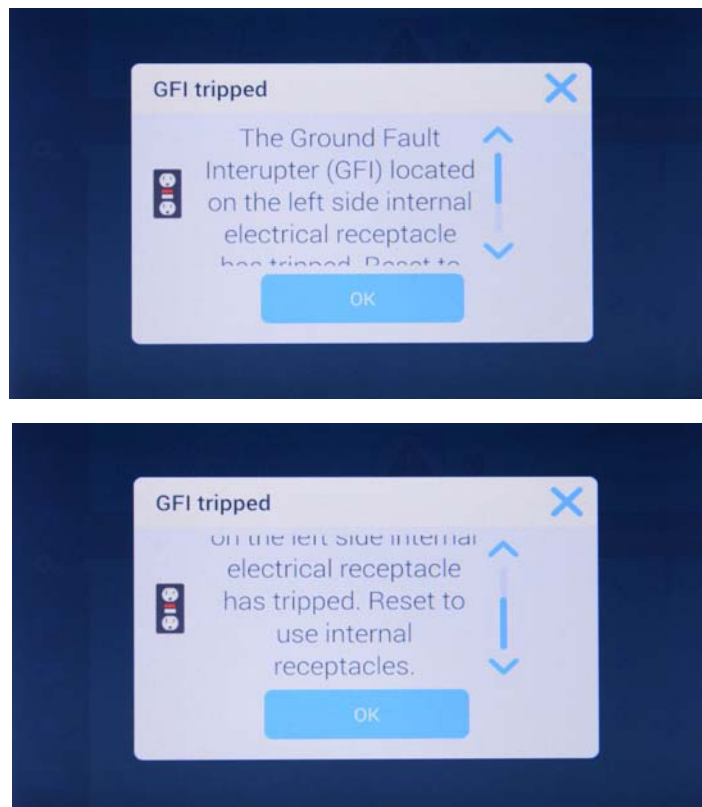

Figure 62 GFI Tripped Alert Details Screen

5. Correct each issue that has caused an alarm.

As you correct the pending issues, they will disappear from the alerts list on the Health Status Warning screen one by one.

When the last issue has been cleared, the screen display returns to the healthy state and the green Health Status Good icon ✅ replaces the yellow Health Status Warning icon 🚨.

Viewing General Status Information

There are two dedicated screens for viewing general status information on a unit that is free of alarms and alerts. The first of the Status Good screens opens when you tap the Health Status Good icon in the Info & Health Status Area of the screen. See the description of the “Info & Health Status Area” on page 40 for details.

Additionally, you may reset the UV light bulb operating hours in this screen.

NOTE Although a reset button appears on-screen, resetting of the HEPA filter operating hours can only be done by an authorized field service technician.

The Status Good screens display the following information:

- First screen:
 - Total Operating Hours including last time the cabinet was run
 - UV light total operating hours, last cycle, and install date
- Second screen:
 - Filter running time, estimated time left, and install date
 - In-Cabinet power receptacles: GFI Status (Ready or Tripped; North American market version only)
 - Air Velocity: Inflow and Downflow

The two screens can be navigated by swiping left or right or tapping the small left/right chevron icons. Two dots signify the number of screens available in this section and indicate which screen you are currently viewing: the dot for the active screen is always solid, while the hidden screen appears in outline shape.

Viewing UV Light Bulb and HEPA Filter Lifetime

To display the remaining useful service life of the UV light bulb and HEPA filter, proceed as follows:

1. Tap the Status Good icon  in the Info & Health Status Area on top of the Main Screen.

The Status Good screen shown in Figure 63 appears, displaying the first suite of status data.

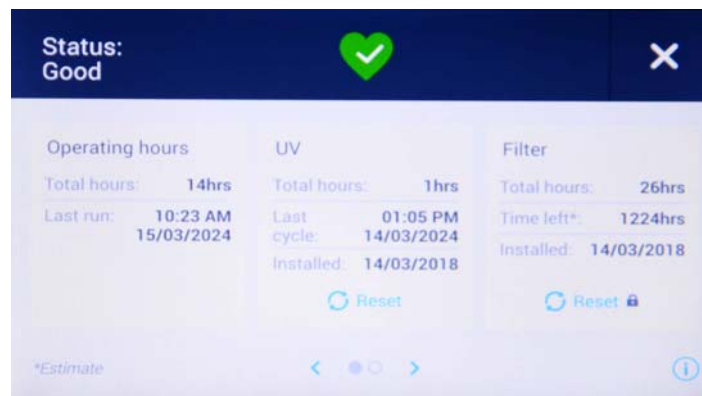

Figure 63 Status Good Screen #1: Operating Hours, UV and Filter

2. If you have just changed the UV light bulb, tap the Reset button below the UV display area.

The UV Total Hours counter and Last Cycle date will be reset to zero and a default date, while the Installed date will be reset to the current date.



Reset the UV operating hours only when you have positively replaced the UV light bulb. Resetting the operating hours without previously replacing the UV light bulb results in a misleading operating hours count. When the lifetime of the UV bulb expires, UV disinfection efficiency may be compromised, but no pertinent alarm message will be given. This may result in latent biohazards that may go unnoticed.

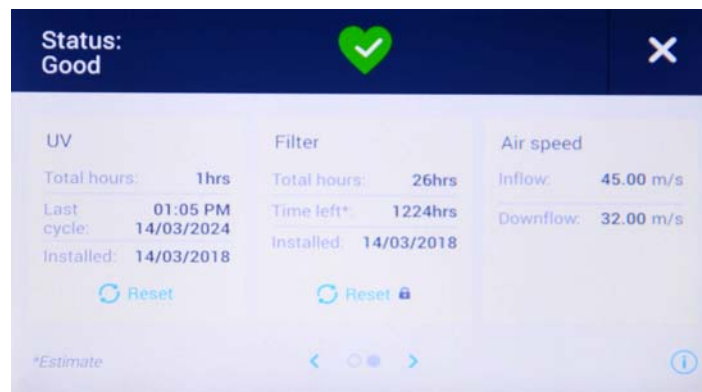

Figure 64 Health Status Good Screen #2: UV, Filter and Air speed

3. Swipe the screen to the left or tap the right blue chevron in the navigation area at the bottom center to display the second suite of status data.
4. When you are done viewing status data, tap the X icon in the upper right corner to close the Status Good screen.

You will be returned to the Main Screen.

Settings

This section explains how to set up the unit using the various options of the Settings screen.

After completing the initial setup process, you can further set up and customize the unit by using the options of the Settings screen shown below in Figure 65.



Figure 65 Settings Screen

The Settings screen opens up when you tap the Settings icon  in the Main Navigation Bar. It offers eight menu items that can be tapped to open further screens with advanced adjustment options:

- Disinfection Cycle: See “Setting UV Disinfection Cycle Time” on page 69.
- Alarms and Alerts: See “Alarms and Alerts Settings” on page 70.
- Programs: See “Programs” on page 76.
- Data Plate: See “Data Plate” on page 86.
- Display: See “Display Settings” on page 80.
- Access Control: See “Access Control” on page 88.
- Factory Settings (password protected): See “Factory Settings” on page 89.
- Field Certification (password protected): See “Field Certification” on page 89.

NOTE Some of these items are also available as shortcuts on the Main Navigation Bar.

Setting UV Disinfection Cycle Time

Tapping the Disinfection Cycle button **UV** takes you to the Disinfection Cycle screen, shown in Figure 66 below. From this screen, you can change the default running time of the UV disinfection cycle. This is the value is used by default when you start the Disinfection cycle by tapping the UV light button in the Control Panel Area of the display window.

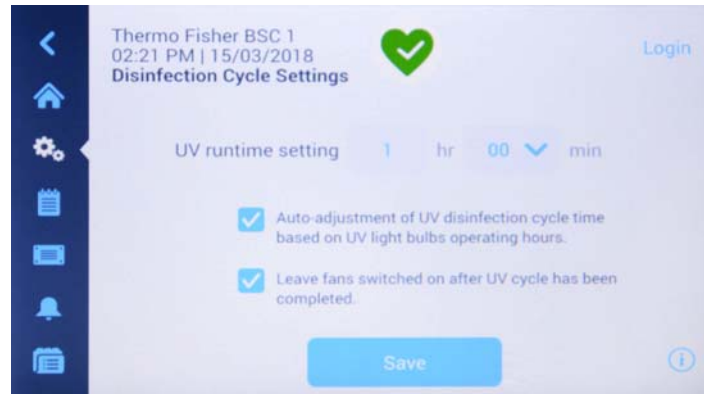



Figure 66 Disinfection Cycle Settings Screen

The Disinfection Cycle screen displays the following fields:

- Time to run UV: Sets the duration of the UV Disinfection cycle from 0 to 24 hours, with additional intervals of 00, 15, 30, and 45 minutes.

Hours are entered by using a calculator-style keypad, minutes are selectable from a drop-down list.

NOTE The default setting is 1 hour, 00 minutes. 0 hours and 00 minutes is NOT a selectable option.

- *Auto adjust UV disinfection cycle time* based on operating hours of UV bulbs: Automatically adjusts cycle time for optimizing the operation of UV bulbs as they age.
- *Keep fans on after UV cycle is complete* keeps the blowers running beyond the UV disinfection cycle. You must turn off the blowers manually by tapping the Fan button .

Proceed as follows to set the Disinfection Cycle time:

1. Tap the Settings icon  on the Main Navigation Bar.
2. Tap the Disinfection Cycle button **UV** on the Settings screen.
3. Tap on the hours field to bring up a “calculator-style” keypad.
4. Enter a duration between 0 and 24 hours.
5. Tap on the arrow in the minutes field and choose 00, 15, 30, or 45 minutes.
6. If you wish to keep the blowers running after the disinfection cycle, tap on the checkbox *Keep fans on after UV cycle*.
7. When you are done choosing the default cycle time, tap the Save button.

A pop-up window appears stating that *Your settings have been saved*. If a disinfection cycle is active at this time, you will be asked whether you would like to apply the changes to the current cycle. A header in the top left corner states: *Settings saved*.

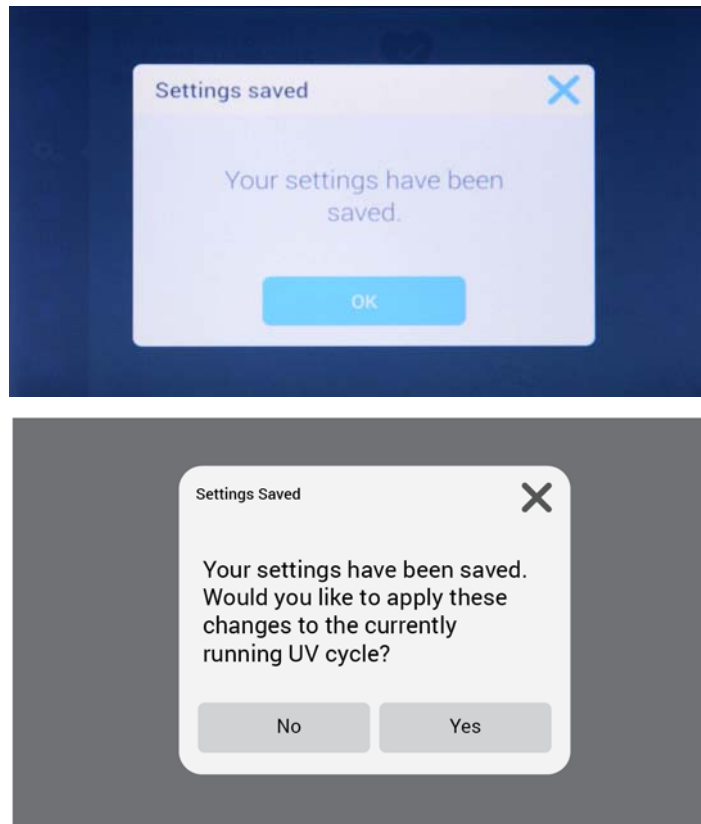

Figure 67 Settings Saved Pop-up Windows for Disinfection Cycle Settings

8. Tap the Yes button to apply the changes and close the window.

NOTE The window will close automatically after 5 seconds if you do not tap the OK button.

You will be returned to the Settings screen.

NOTE If you have entered this screen by tapping the UV button on the Main Navigation Bar while the UV disinfection cycle was running, you will be returned to the home screen instead.

Alarms and Alerts Settings

Tapping the Alarms and Alerts button  on the Settings screen takes you to the Alarms and Alerts Settings screen, shown in Figure 68 below.

From the alarms and alerts setting screen, you may change the volume, tone, and timing of several audible alarms and alerts emitted by the Biological Safety Cabinet.

Selections are made by tapping dropdown lists on the screen. You may change one, several, or all of the dropdown lists before committing your selections with the Save button.

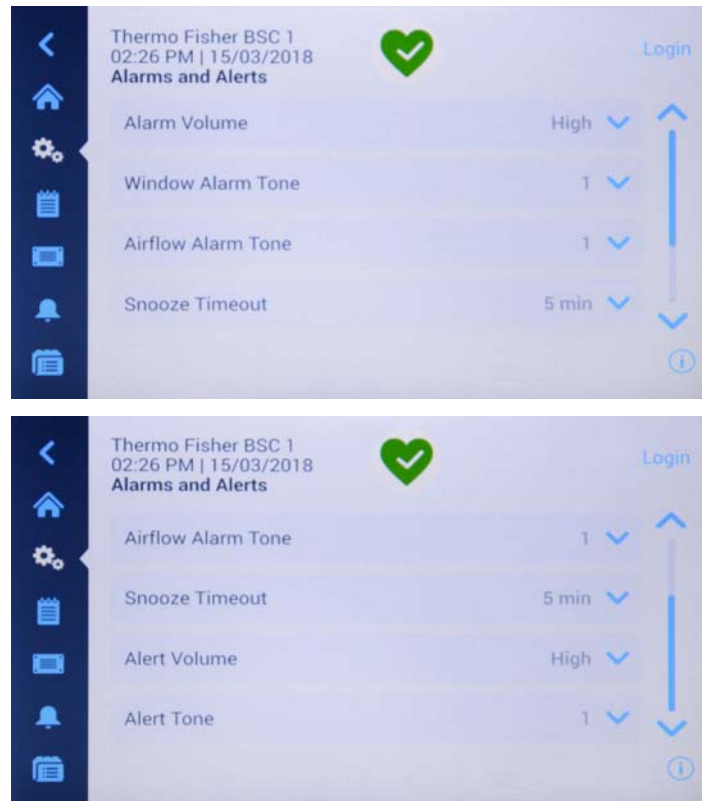

Figure 68 Alarms and Alerts Settings Screen

Alarm Volume

You may change the volume of the alarm tone directly on the main Alarms and Alerts settings screen by just tapping on the dropdown list labeled Alarm Volume (see Figure 69 below) and selecting one of the three Low, Medium, or High options.





Figure 69 Alarms and Alerts Settings: Alarm Volume Options



The alarm volume should be adjusted in the alarm settings screen according to the sound level of the environment lab.

To change the Alarm Volume, proceed as follows:

1. Tap the Settings icon  on the Main Navigation Bar.
2. Tap the Alarms and Alerts button  on the settings screen.

Alternatively, you can also tap the Alarms and Alerts icon  on the Main Navigation Bar to open the Alarms and Alerts Settings screen.

3. Tap the Alarm Volume dropdown menu and choose an option.

The alarm tone will play briefly with the newly chosen volume.

4. Save your changes as explained in the section “Saving Changes” on page 75, or change any other desired option on the Alarms and Alerts Settings screen.

Window Alarm Tone

You may change the alarm tone for the front window directly on the main Alarms and Alerts settings screen by just tapping on the dropdown list labeled Window Alarm Tone (see Figure 70 below) and selecting one of the three options.

NOTE The naming of the options may differ in each country.

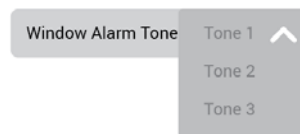





Figure 70 Alarms and Alerts Settings: Window Alarm Tone Options

To change the Window Alarm Tone, proceed as follows:

1. Tap the Settings icon  on the Main Navigation Bar.
2. Tap the Alarms and Alerts button  on the Settings screen.

Alternatively, you can also tap the Alarms and Alerts icon  on the Main Navigation Bar to open the Alarms and Alerts Settings screen.

3. Tap the Window Alarm Tone dropdown menu and choose an option.

The selected alarm tone will play briefly.

4. Save your changes as explained in the section “Saving Changes” on page 75, or change any other desired option on the Alarms and Alerts Settings screen.

Airflow Alarm Tone

You may change the alarm tone for low or high airflow conditions directly on the main Alarms and Alerts settings screen by just tapping on the dropdown list labeled Airflow Alarm Tone (see Figure 70 below) and selecting one of the three options.

NOTE The options may be named differently, depending on the country.

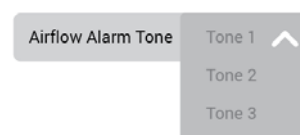



Figure 71 Alarms and Alerts Settings: Airflow Alarm Tone Options

To change the Airflow Alarm Tone, proceed as follows:

1. Tap the Settings icon  on the Main Navigation Bar.
2. Tap the Alarms and Alerts button  on the Settings screen.

Alternatively, you can tap the Alarms and Alerts icon  on the Main Navigation Bar to open the Alarms and Alerts Settings screen.

3. Tap the Airflow Alarm Tone dropdown menu and choose an option.

The selected alarm tone will play briefly.

4. Save your changes as explained in the section “Saving Changes” on page 75, or change any other desired option on the Alarms and Alerts Settings screen.

Snooze Timeout

You may set the timeout period during which an alarm is temporarily silenced when you press the Snooze button directly on the main Alarms and Alerts settings screen. This is done by tapping on the dropdown list labeled Snooze Timeout (see Figure 72 below) and selecting one of the periods.

NOTE Applicable BSC standards in effect may not allow temporary muting of audible alarm.

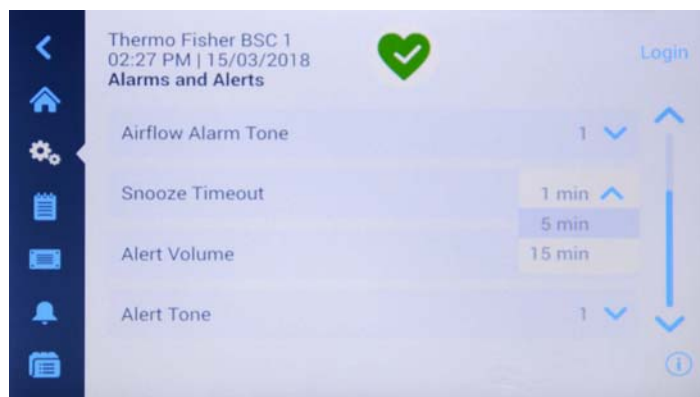





Figure 72 Alarms and Alerts Settings Window with Snooze Timeout Options Expanded

To change the Snooze Timeout period, proceed as follows:

1. Tap the Settings icon  on the Main Navigation Bar.
2. Tap the Alarms and Alerts button  on the Settings screen.

Alternatively, you can tap the Alarms and Alerts icon  on the Main Navigation Bar to open the Alarms and Alerts Settings screen.

3. Tap the Snooze Timeout dropdown menu and choose an option.

NOTE The default option is 5min.

The time period in the Snooze Timeout dropdown will change to the new setting.

4. Save your changes as explained in the section “Saving Changes” on page 75, or change any other desired option on the Alarms and Alerts Settings screen.

Alert Volume

You may change the volume of the alert tone directly on the main Alarms and Alerts settings screen by just tapping on the dropdown list labeled Alert Volume (see Figure 73 below) and selecting one of the Low, Medium, or High options.



Figure 73 Alarms and Alerts Settings: Alert Volume Options

To change the alert volume, proceed as follows:

1. Tap the Settings icon  on the Main Navigation Bar.
2. Tap the Alarms and Alerts button  on the Settings screen.

Alternatively, you can tap the Alarms and Alerts icon  on the Main Navigation Bar to open the Alarms and Alerts Settings screen.

3. Tap the Alert Volume dropdown menu and choose an option.

The alert tone will play briefly with the newly chosen volume.

4. Save your changes as explained in the section “Saving Changes” on page 75, or change any other desired option on the Alarms and Alerts Settings screen.

Alert Tone

You may choose an alert tone directly on the main Alarms and Alerts settings screen by just tapping on the dropdown list labeled Alert Tone (see Figure 74 below) and selecting one of the three options.

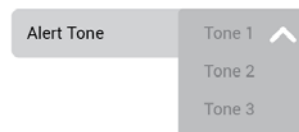





Figure 74 Alarms and Alerts Settings: Alert Tone Options

To change the alert tone, proceed as follows:

1. Tap the Settings icon  on the Main Navigation Bar.
2. Tap the Alarms and Alerts button  on the Settings screen.

Alternatively, you can tap the Alarms and Alerts icon  on the Main Navigation Bar to open the Alarms and Alerts Settings screen.

3. Tap the Alert Tone dropdown menu and choose an option.

The selected alert tone will play briefly.

4. Save your changes as explained in the section “Saving Changes” on page 75, or change any other desired option on the Alarms and Alerts Settings screen.

Saving Changes

The Save button at the bottom of the screen lets you commit any changes you have made to the setup. The Save button will appear as soon as you make any changes to any of the dropdowns on the screen.

1. When you are done making settings, tap the Save button.

A pop-up window appears, stating that *Your settings have been saved*. A header in the top left corner states: **Settings saved**.

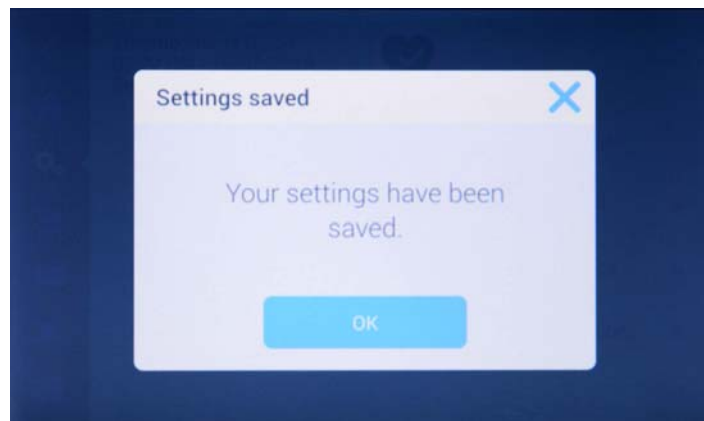

Figure 75 Settings Saved Screen

2. Tap the OK button to apply the changes and close the window.

NOTE The window will close automatically after 5 seconds if you do not tap the OK button.

3. If you wish to cancel saving, tap the X icon in the top right corner of the pop-up window.

Another pop-up window appears, asking whether you are sure about exiting. You may then choose to tap the Discard Changes button and cancel saving for good, or tap the Save Changes button and continue saving.

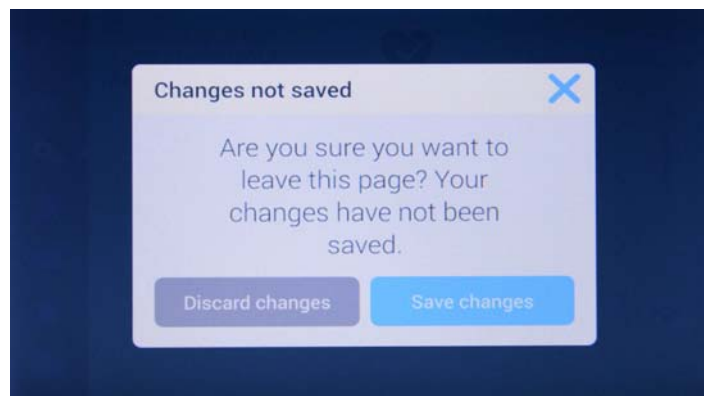

Figure 76 Changes Not Saved Message

You will be returned to the Settings screen.

Programs

Tapping the Programs button in the Settings screen takes you to the Programs screen shown in Figure 77. The Programs screen lets you set up the AutoStart and AutoStop buttons that switch the Biological Safety Cabinet on and off, respectively.

The settings you make in these screens determine which of the unit's functions are turned on by default when you press the AutoStart button or which functions are turned off when you press the AutoStop button in the Control Panel.

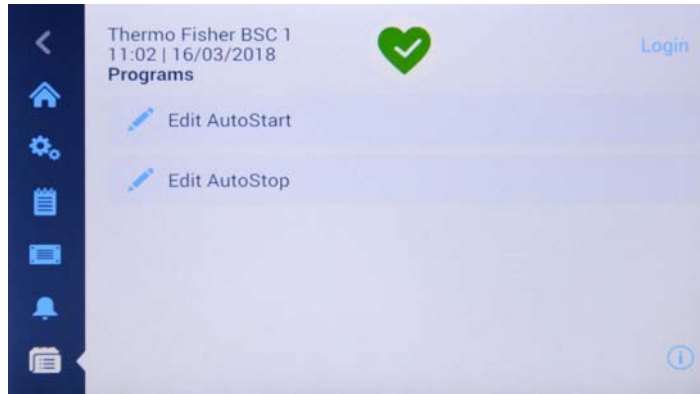



Figure 77 Programs Screen

The Programs screen offers two menu buttons that can be tapped to open further screens with editable settings for the auto-start and auto-stop timers.

Setting Up AutoStart

To set up the Biological Safety Cabinet for AutoStart, proceed as follows:

1. Tap the Settings icon  on the Main Navigation Bar, followed by the Programs button  on the Settings screen.

Alternatively, you can also tap the Programs icon  on the Main Navigation Bar.

2. Tap the Edit AutoStart button on the Programs screen.

Doing so will open up the Edit AutoStart screen shown in Figure 78 below. By default, the **Edit AutoStart** screen comes up with all five checkboxes already selected, as shown in the top image in Figure 78.

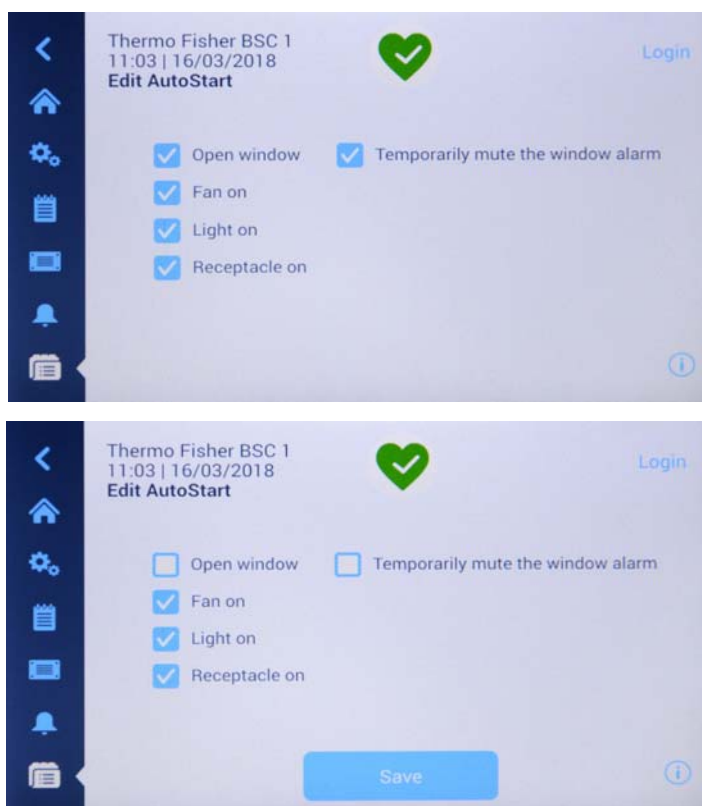

Figure 78 Programs: Edit AutoStart Screen

3. Tap to select or deselect the option checkboxes as required:
 - *Window Open* will automatically open the window to the working position when the AutoStart button is pressed.
 - *Temporarily mute window alarm* will mute the window alarm while the window is moving from the closed to the working position.
 - *Fan On* turns on the blowers when the AutoStart button is pressed.
 - *Light On* turns on the sample chamber illumination when the AutoStart button is pressed.
 - *Receptacle On* applies electrical power to the power outlets in the sample chamber when the AutoStart button is pressed.



If you have made any changes, the Save button appears at the bottom of the screen, as shown in the bottom image in Figure 78.

4. When you are done choosing AutoStart options, tap the Save button.
5. To commit the changes, tap the OK button in the pop-up window that appears (see “Saving Changes” on page 75).

You will be returned to the settings screen.

Setting Up AutoStop

To set up the Biological Safety Cabinet for AutoStop, proceed as follows:

1. Tap the Settings icon  on the Main Navigation Bar, followed by the Programs button  on the Settings screen.

Alternatively, you can also tap the Programs icon  on the Main Navigation Bar.

2. Tap the Edit AutoStop button on the Programs screen.

Doing so will open up the Edit AutoStop screen shown in Figure 79 below. By default, the **Edit AutoStop** screen comes up with the *Fan off after UV* option selected, the Temporarily mute the window alarm checkbox deselected, and all remaining checkboxes selected (top image in Figure 79).

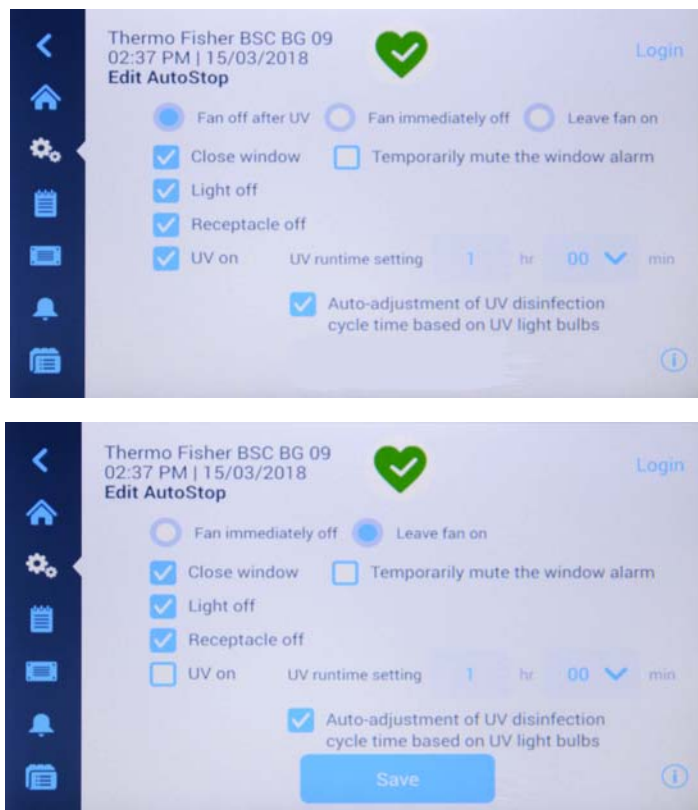

Figure 79 Programs: Edit AutoStop Screen

3. Tap to select one of three radio buttons to determine whether and when the blowers should be turned off after the AutoStop button has been pressed:
 - *Fan off after UV* selects the *UV On* option to have the Biological Safety Cabinet run UV disinfection after AutoStop.
 - *Fan off Immediately*
 - *Leave Fan On*
4. Tap to select or deselect any of the four checkboxes as required:

- *Window Close* will automatically close the window.

NOTE If the window is set to close as part of AutoStop, you must press and hold the AutoStop button while the window is closing. This is a safety feature.

- *Temporarily mute window alarm* will mute the window alarm while the window is moving from the working to the closed position.
- *Light Off* turns off the sample chamber illumination when the AutoStop button is pressed.
- *Receptacle Off* shuts off electrical power to the power outlets in the sample chamber when the AutoStop button is pressed.
- *UV On* starts the UV disinfection cycle when the AutoStop button is pressed.

The *UV On* setting has additional parameters. You may set:

- Time to run UV in hours (1-24 hours) and minutes (00, 15, 30, 45 minutes). You may change the hours by tapping in the hour field and entering a number from 1 to 24 in the calculator style keypad. You may change the minutes by selecting any of these four options from a dropdown list: 00, 15, 30, 45.
- You may also want to keep the blowers running after the UV cycle is complete by checking the *Leave Fan On* option explained further above. Default is unchecked.

If you have made any changes, the Save button appears at the bottom of the screen.

5. When you are done choosing AutoStop options, tap the Save button (bottom image in Figure 79).
6. To commit the changes, tap the OK button in the pop-up window that appears (see “Saving Changes” on page 75).

You will be returned to the settings screen.

Display Settings

Tapping the Display button  on the Settings screen takes you to the Display Settings screen shown in Figure 80.

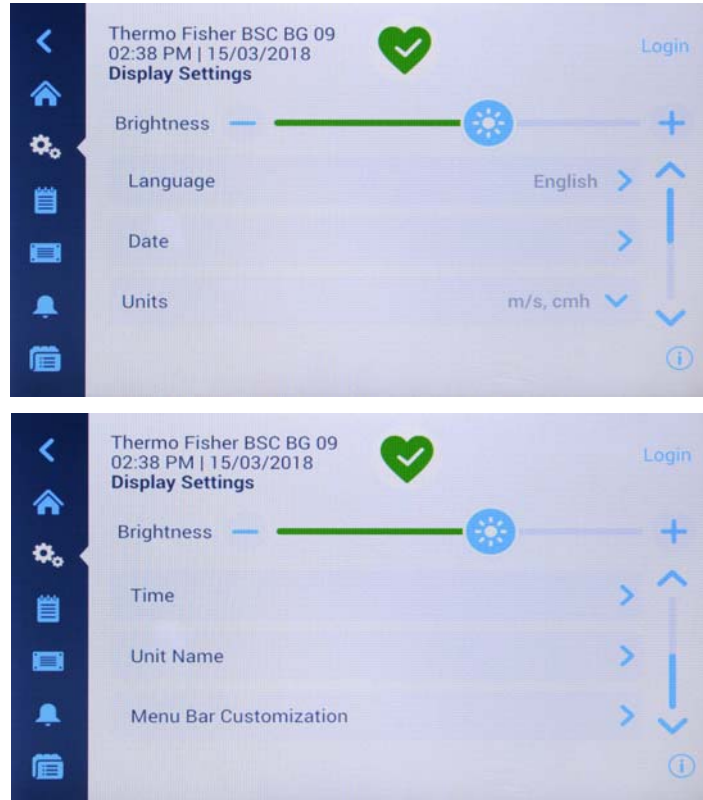

Figure 80 Display Settings Screen



The Display Settings screen lets you make and/or select the following settings:

- Brightness; see “Setting Brightness” on page 80
- Language; see “Setting the Display Language” on page 81
- Date; see “Setting the Date” on page 84
- Units (of Measurement); see “Setting Units of Measurement” on page 82
- Time; see “Setting the Time of Day” on page 84
- Unit Name; see “Setting the Unit Name” on page 82
- Menu Bar Customization; see “Customizing the Menu Bar” on page 86

Setting Brightness

Brightness is set on the main Display Settings screen shown in Figure 80.

Proceed as follows to change brightness of the screen:

1. Tap the Settings icon  on the Main Navigation Bar.
2. Tap the Display button  on the Settings screen.

3. Tap the Brightness button on the Display Settings screen.
4. Drag the Brightness slider button to the right or to the left, or tap the plus („+“) or („-“) button to increase or decrease.

If you have made any changes, the Save button appears at the bottom of the screen.



5. When you are done adjusting brightness, tap the Save button.
6. To commit the changes, tap the OK button in the pop-up window that appears (see “Saving Changes” on page 75).

You will be returned to the Display Settings screen.

Setting the Display Language

The Language button on the Display settings screen opens the Language screen where you may choose a display language of your choice. This setting overwrites the display language selection made during the initial setup, as described in the section “Initial Setup” on page 33.

Proceed as follows to set the display language:

1. Tap the Settings icon  on the Main Navigation Bar.
2. Tap the Display button  on the Settings screen.
3. Tap the Language button on the Display Settings screen.

The Language screen appears with a wheel picker, prompting you to choose a display language, as shown in Figure 81 below.



Figure 81 Display Settings: Language Screen

4. Tap the up/down arrows or swipe your finger across the wheel up or down to set the language (default is English).

If you have made any changes, the Save button appears at the bottom of the screen.

5. When you are done choosing the language, tap the Save button.
6. To commit the changes, tap the OK button in the pop-up window that appears (see “Saving Changes” on page 75).



You will be returned to the Display Settings screen.

Setting Units of Measurement

The units of measurement for airflow can be chosen directly on the main Display Settings screen shown in Figure 80. A dropdown list lets you choose between:

- metric units: m/s (meters per second), cmh (cubic meters per hour)
- imperial units: fpm (feet per minute), cfm (cubic feet per minute)

Proceed as follows to switch units of measurement:

1. Tap the Settings icon  on the Main Navigation Bar.
2. Tap the Display button  on the Settings screen.
3. Tap the Units of Measure dropdown list on the Display Settings screen.

The dropdown list is expanded and displays its options, as shown in Figure 82 below.

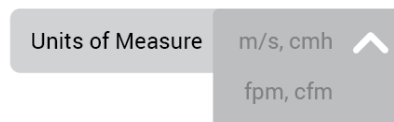

Figure 82 Units Of Measure Dropdown Menu



4. Choose either m/s, cmh for metric units or fpm, cfm for imperial units (default is metric).
If you have made any changes, the Save button appears at the bottom of the screen.
5. When you are done choosing the units of measurement, tap the Save button.
6. To commit the changes, tap the OK button in the pop-up window that appears (see “Saving Changes” on page 75).

You will be returned to the Display Settings screen.

Setting the Unit Name

You may set a name for the unit that will be displayed above the time/date field in the Info & Health Status Area at the top of all screens.

Proceed as follows to edit the name of the unit:

1. Tap the Settings icon  on the Main Navigation Bar.
2. Tap the Display button  on the Settings screen.
3. Tap the Unit Name button on the Display Settings screen.

The **Unit Name** screen appears, as shown in Figure 83 below.

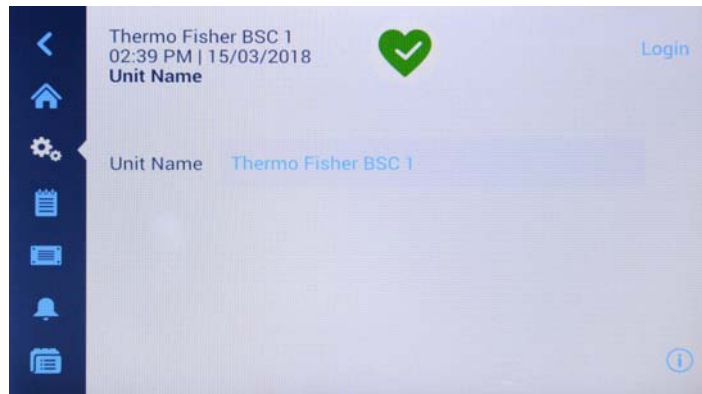

Figure 83 Display Settings: Unit Name Screen

4. Inspect the Unit name field:

If no Unit Name has been previously set, the Unit Name field will read *Tap to enter*.

If a Unit Name has been previously set, that name appears in the *Unit Name* field.

5. Tap on the *Unit Name* field to display a full keypad, as shown in Figure 84 below.

If no *Unit Name* has been previously set, a cursor will appear in the *Unit Name* field and prompt you to start typing.

If a unit name has been previously set, that name will be selected for overwriting.

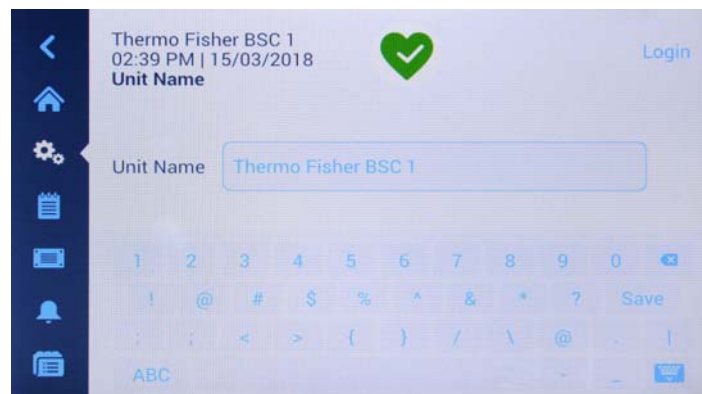

Figure 84 Display Settings: Changing Unit Name Screen



6. Type the desired unit name.
7. When you are done typing, do one of the following:
 - a. Tap the Save button on the keypad.
 - b. Tap anywhere outside of the keypad and the *User Name* field to hide the keypad, then tap the Save button at the bottom of the screen.
8. To commit the changes, tap the OK button in the pop-up window that appears (see “Saving Changes” on page 75).

You will be returned to the Display Settings screen.

Setting the Date

The Date button in the Display screen opens the Date screen shown in Figure 85 below. The Date screen lets you set the date that appears in a date field in the Info & Health Status Area at the top of all screens.

Proceed as follows to set the date:

1. Tap the Settings icon  on the Main Navigation Bar.
2. Tap the Display button  on the Settings screen.
3. Tap the *Date* button on the Display Settings screen.

The *Date* screen appears with a wheel picker, prompting you to set the date, as shown in Figure 85 below.

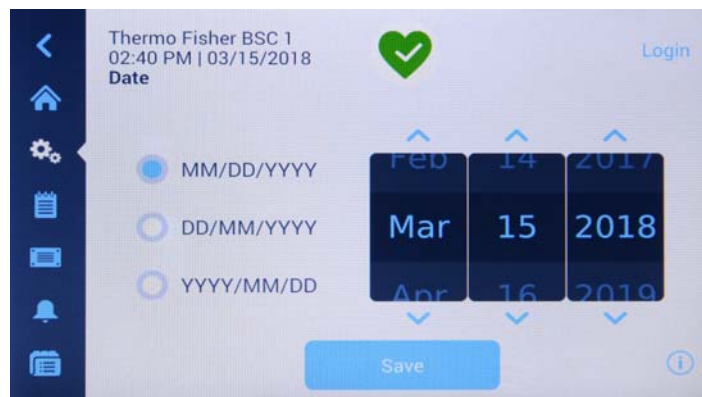

Figure 85 Display Setting: Date Screen

4. Tap the *MM/DD/YYYY*, *DD/MM/YYYY*, or *YYYY/MM/DD* radio button on the left side of the screen to choose a date format.

The segments of the wheel picker screen are rearranged to reflect the selected date format. For example, if you select the *DD/MM/YYYY* radio button, the wheel picker will change to 01 | Jan | 2016.

5. Tap the up/down arrows or swipe your finger across the wheel up or down to set the current month, day, and year on each of the three wheel picker segments.

If you have made any changes, the Save button appears at the bottom of the screen.



6. When you are done setting the date, tap the Save button.
7. To commit the changes, tap the OK button in the pop-up window that appears (see “Saving Changes” on page 75).

You will be returned to the Display Settings screen.

Setting the Time of Day

The Time button in the Display screen opens the Time screen shown in Figure 86 below. The Time screen lets you set the time of day that appears in a time field in the Info & Health Status Area at the top of all screens.

Proceed as follows to set the date:

1. Tap the Settings icon  on the Main Navigation Bar.
2. Tap the Display button  on the Settings screen.
3. Tap the Time button on the Display Settings screen.

The Time screen appears with a three-segmented wheel picker, prompting you to set the time of day, as shown in Figure 86 below.

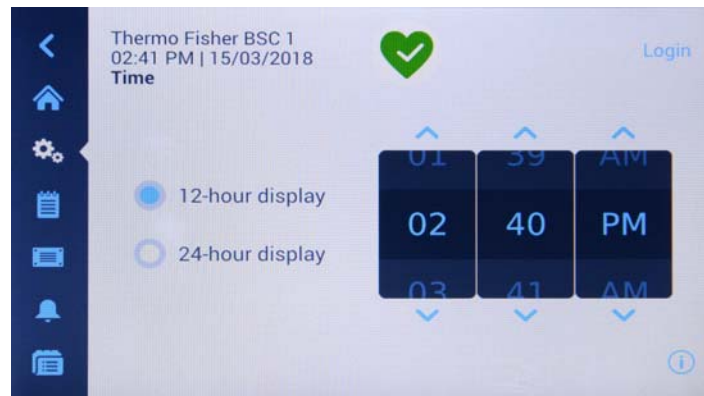

Figure 86 Display Setting: Time Screen with 12-hour AM/PM Format

4. If desired, tap the *24hr Display* radio button on the left side of the screen to choose the 24-hour time format. (Default time format is AM/PM, 12-hour format.)

The segments of the wheel picker screen are rearranged to reflect the 24-hour time format, as shown in Figure 87 below.



Figure 87 Display Setting: Time Screen with 24-hour Format

5. Tap the up/down arrows or swipe your finger across each wheel up or down to set the current time in hours and minutes.

If you have made any changes, the Save button appears at the bottom of the screen.



6. When you are done setting the time of day, tap the Save button.
7. To commit the changes, tap the OK button in the pop-up window that appears (see “Saving Changes” on page 75).

You will be returned to the Display Settings screen.

Customizing the Menu Bar

The Menu Bar Customization screen shown in Figure 88 lets you swap the three bottom icons in the left-hand Main Navigation Bar.

Proceed as follows to swap any of the bottom icons in the left-hand Main Navigation Bar:

1. Tap the Settings icon  on the Main Navigation Bar.
2. Tap the Display button  on the Settings screen.
3. Tap the Menu Bar Customization button on the Display Settings screen.

The Menu Bar Customization screen appears, as shown in Figure 88 below.

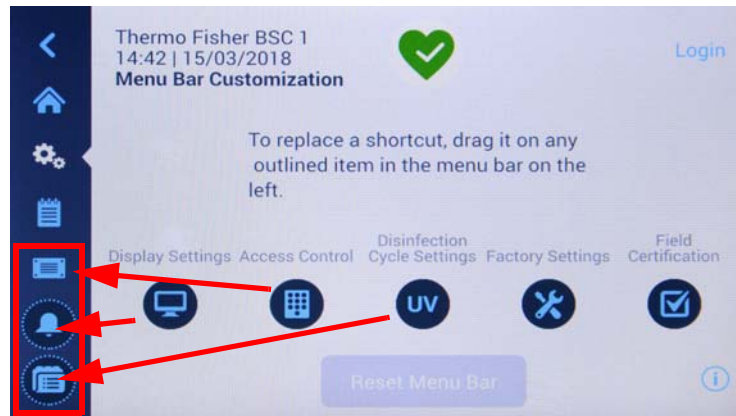

Figure 88 Display Setting: Menu Bar Customization Screen with Icon Swapping Options

4. Tap one of the five icons in the center of the Menu Bar Customization screen.
5. Drag the icon on top of one of the three highlighted icons in the left-hand Main Navigation Bar.

The icon you have just dragged will appear in the Main Navigation Bar. The icon previously displayed in the Main Navigation Bar will appear among the five icons in the center of the screen, along with the pertinent text label.

If you have made any changes, the Save button appears at the bottom of the screen.

6. When you are done customizing the Main Navigation Bar, tap the Save button.
7. To commit the changes, tap the OK button in the pop-up window that appears (see “Saving Changes” on page 75).

You will be returned to the Display Settings screen.

Data Plate

Tapping the Data Plate icon  on the Main Navigation Bar takes you to the Data Plate screen shown in Figure 89. The Data Plate screen displays pertinent information about the Biological Safety Cabinet, including:

- Model
- Release

- Serial No
- Electrical
- Class/Type

All information on the first-level Data Plate screen is read-only and cannot be edited.



Figure 89 Data Plate Screen

Viewing and Editing Contact Information

Tapping the Contact Us button on the Data Plate screen takes the user to the Contact Us screen shown in Figure 90. The Contact Us screen lists addresses and telephone numbers of Thermo Scientific service organizations. You may view and/or edit contact information for Thermo Fisher Scientific to keep the contact information in the unit up-to-date.

The page is divided into three separate boxes with headers for: US, Europe, and Asia.

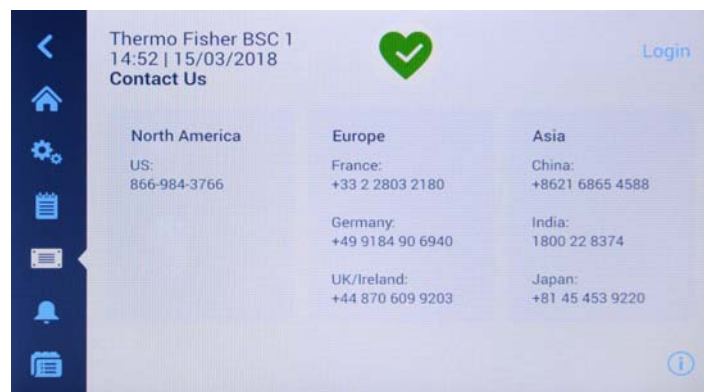

Figure 90 Data Plate: Contact Us Screen

You may tap into the three fields to edit or add text. A keyboard (see Figure 91) appears when the user taps into any of the boxes.



Figure 91 Data Plate: Editing the Contact Us Screen

The headers are not editable. You can use the up/down arrows to scroll through the box if there is more content than can be seen on one screen, or use a swiping gesture to scroll the box.

Access Control

Tapping the Access Control button  in the Settings screen takes you to the Login screen shown in Figure 38. After entering the passcode the Access Control screen Figure 92 is shown. The Access Control screen allows you to activate Secure Mode, in which a passcode will be requested from all users who want to operate the unit (turn blowers on/off, etc.) or change its settings.

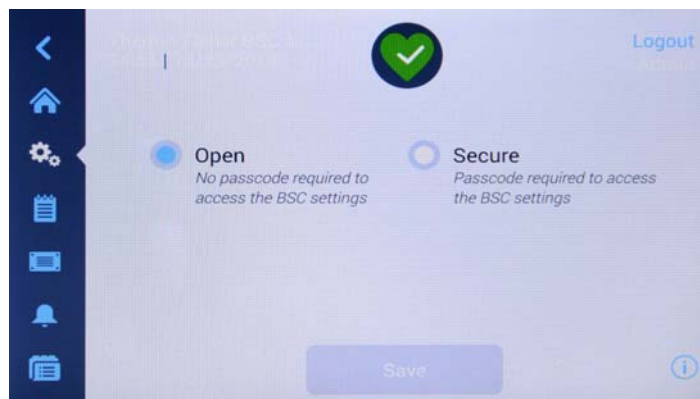

Figure 92 Access Control Screen in Open Mode

By default, the Biological Safety Cabinet is in Open Mode, that is, you do not need to enter a passcode to access and operate the unit.

NOTE Only the Factory Settings and Field Certification screens require specific passcodes, which are different from the admin passcode. These screens are reserved for Thermo Scientific field service.

With a new Login the mode can be changed again.

After the mode has changed from Open to Secure by tapping the Secure radio button, the Save button has turned blue to indicate that you may save your changes now.

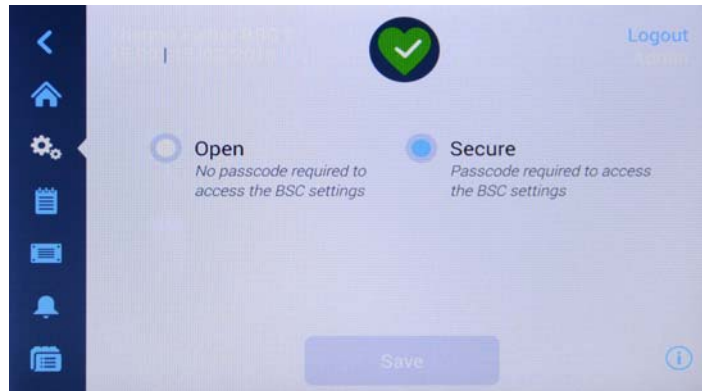



Figure 93 Access Control Screen in Secure Mode

You will be returned to the Access Control screen. The Access Control screen now has a Logout command and user name readout in the upper right corner.

Factory Settings

Tapping the Factory Settings button  in the Settings screen takes you to the Factory Settings screen. Access to the Factory Settings screen is reserved to Thermo Scientific Field Service and requires a special passcode (which differs from the Admin passcode).

Field Certification

Tapping the Field Certification button  in the Settings screen takes you to the field certification screen. Access to the Field Certification screen is reserved to Thermo Scientific Field Service and requires a special passcode (which differs from the Admin passcode).

Event Log

Tapping the Event Log  icon in the Settings screen takes you to the Event Log screen shown in Figure 94. The Event Log screen displays a complete and continuous list of events and alarms from the last 24 hours. For events > 24 hours the data log must be downloaded to a USB stick.

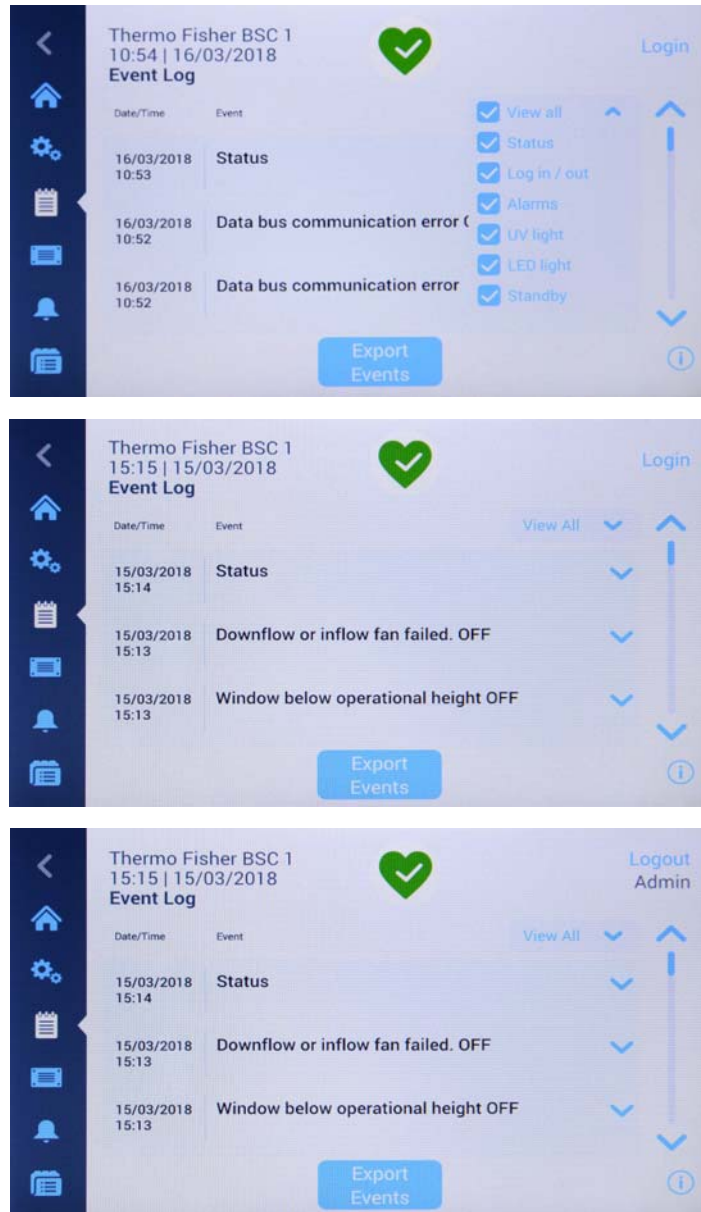

Figure 94 Event Log Screen

The Event Log screen displays the following information:

- Periodic status, as captured in 1 minute increments by default.
- Events, including alarms and alerts as well as changes to settings:
 - For each alarm the time activated and the time deactivated is recorded. Alarms include:
 - inflow alarm low

- inflow alarm high
- downflow alarm low
- downflow alarm high
- window too low
- window too high
- external exhaust alarm, if applicable
- For each alert, the time activated is recorded. Alerts include:
 - 5% filter life remaining
 - 5% UV light life remaining
 - GFI tripped (US versions only)
 - annual field certification due
- Changes to settings include:
 - changes to the language, date, or time
 - changes to login/logout and/or associated passcode
 - reset of UV bulb, filters, or field certification timers
- Status of blowers (on, off, reduced mode)
- Status of sample chamber illumination (on/off)
- Status of UV (on/disinfection cycle/off)
- Status of internal receptacle (on/off)
- Status of GFI (tripped/not tripped), if applicable

Viewing the Event Log

Proceed as follows to view the Event Log:

1. Tap the Event Log  icon on the Main Navigation Bar.

The Event Log screen shown in Figure 95 appears.

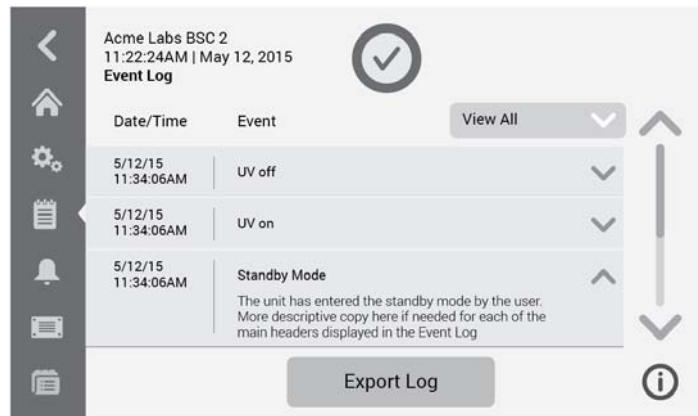

Figure 95 Event Log Screen: Standby Mode Expanded

2. Tap the up and down arrows to the right of the event list to scroll.
3. Tap on any list item in the Event Log to expand it and view more detailed information, as shown for the Standby Mode item in Figure 95.

Filtering the Event Log

The dropdown menu labeled View All on top of the event list allows the user to customize the content displayed in the Event Log. By default, the dropdown list is pre-set to View All, that is, the event list is unfiltered and shows the full content of the event log. You can expand the dropdown list and exclude or include whole classes of events to make the event list easier to read.

Proceed as follows to filter the event list:

1. Tap the dropdown menu labeled View All in the Event Log screen.

The dropdown list is expanded, displaying the filtering options shown in Figure 96.

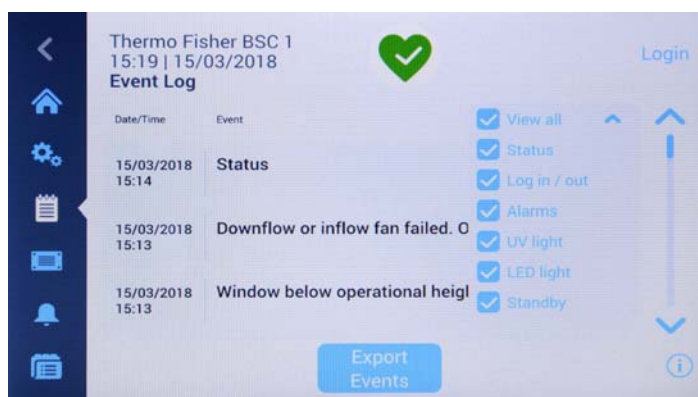

Figure 96 Filtering the Event Log

2. Uncheck the classes of events you wish to exclude from the event list.
The list in the event log is refreshed, displaying only the items you have left checked. The View All option is unchecked.
3. To undo filtering, check View All.

All options are checked again, and the full event list display is restored.

NOTE Unchecking options for onscreen viewing is only for the current session. If you navigate away from the event log screen and then return, you will find View All highlighted again.

Exporting the Event Log

The Event Log can be exported in Comma Separated Values (CSV) format, writing six months of data. You must insert a USB drive to download the file to into the USB port of the unit.

Proceed as follows to export the event log:

1. Insert a USB drive into the USB port, which is located in a small bay next to the display window.
2. Tap the Export Log button in the Event Log screen.
3. If you have not inserted a USB drive yet, the pop-up window shown in Figure 97 appears, asking you to insert a USB drive to export the log to. The window will close automatically when you insert a valid USB drive, and the export process will start.

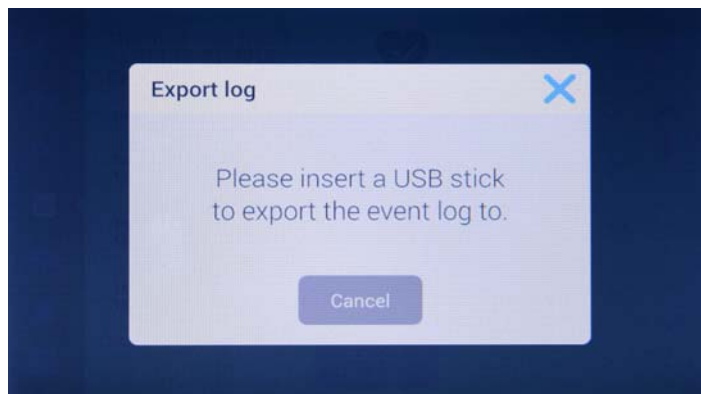

Figure 97 Export Log Screen: Missing USB Drive Alert

- a. If you have inserted a USB drive that is not writable or readable, the pop-up window shown in Figure 98 appears, stating the drive is not readable and asking you to insert a different USB drive.

If you have inserted a valid USB drive, the export will start immediately. The pop-up window shown in Figure 98 appears, cautioning you not to remove the USB drive until the transfer is complete.

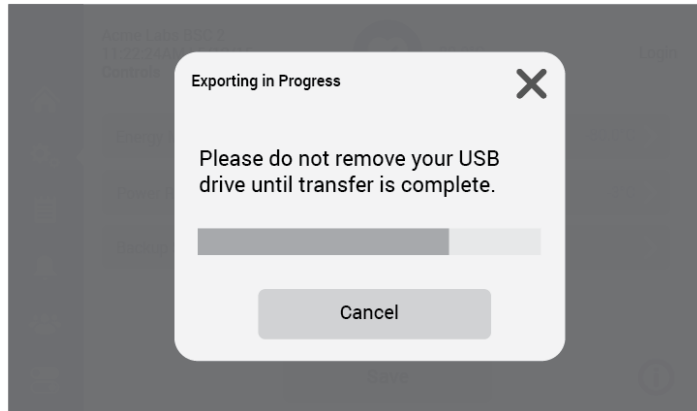

Figure 98 Export Log Screen: Exporting Event Log in Progress Message

4. If you wish to exit, you may tap the Cancel button or the X icon to close this window and return to the Event Log.
5. When the export process has been completed, the final pop-up window shown in Figure 99 appears, announcing that you may remove the USB drive now.

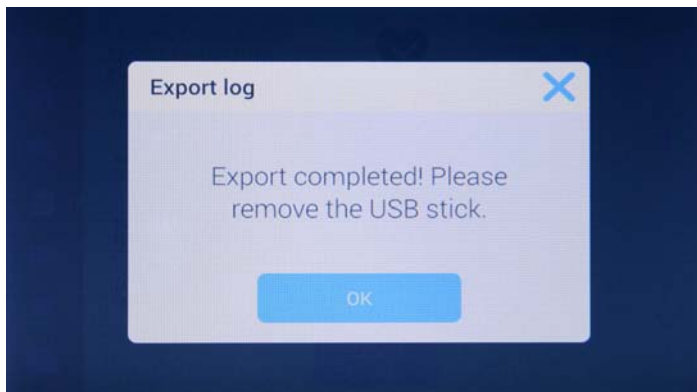

Figure 99 Event Log Screen: Export Completed

Preparation

Hygiene preparations for the sample chamber

The sample chamber surfaces and the accessories required for the work process must be disinfected and cleaned in accordance with the hygiene guidelines set forth for the application.

Preparing the sample chamber

Installing the accessories:

1. Lower the front window completely.
2. Open the front cover or move the front window into the maximum opening position.
3. Position the accessories in the working area of the workplate.
4. Close the front cover.
5. Move the front window to its working position and wait until the airflow has stabilized.



Operational safety!

The personal and material protection is ensured only if the airflow system of the device is working properly. If the alarm system issues failure messages when the front window is in the working position, stop all applications that may release harmful aerosols!

6. Then place samples into the chamber.
7. To interrupt the work process or for extensive experiment cycles without manual interference, switch the device to standby mode. When the working opening is completely closed, the safety cabinet is sealed aerosol-tight.

Response to failure messages

Failure messages are displayed on the touchscreen display as outlined in the sections “Alarms” on page 60 and “Alerts” on page 63 . If one of these messages is displayed, contact the Technical Service immediately.

To isolate the cause of the failure, the operating personnel must perform only the following tests and measures:

- Check to see if the exhaust air opening on top of the cabinet is blocked.
- Ensure that the on-site exhaust air system is activated.
- Close doors and windows in the laboratory to prevent drafts.
- Switch off devices in the vicinity of the safety cabinet that cause air turbulence or emit excessive heat.
- Open flames in the sample chamber may impair airflow conditions.

Work rules

The observance of work rules ensures a minimum of operational safety when handling the safety cabinet.

Before starting an operation:

- Take off jewelry.
- Put on required personal protective gear, e.g. hand, face, or body protection.
- Clean and disinfect sample chamber surfaces at regular intervals.

During an operation:

- Place samples only within the defined work area of the workplate.
- Do not place unnecessary items into the sample chamber.
- Use only disinfected and cleaned accessories for the work process.
- Do not cause air turbulence, by quick hand, arm or body movement in the sample chamber or in front of the work opening.
- Do not place accessories into the sample chamber that cause air turbulence or emit excessive heat.
- Do not block air circulation at the ventilation slots of the workplate.

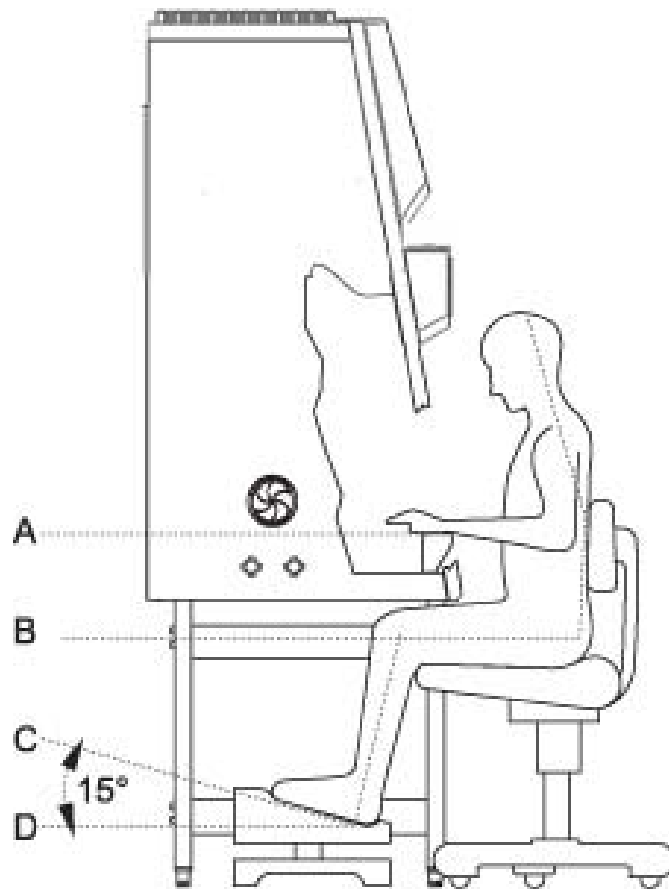
Sitting posture during work:**Figure 100** Sitting posture

To prevent risks to health, a height-adjustable working chair with an adjustable seat back should be used during extended work periods at the safety cabinet.

- A** When the forearm rests on the armrest, it should be in an almost horizontal position.
- B** When the thigh is in a horizontal position, the angle between thigh and lower leg should exceed 90°.

To ensure a compensation between floor and sitting height, a footrest (DIN 4556) should be used. The minimal effective surface of the footrest should be 45 x 35 cm.

- C** The slope should be adjustable within a range of 5° to 15°.
- D** The adjustable height should extend to a minimum of 11 cm above the floor.

After finishing an operation:

- Remove samples from the sample chamber and store them properly.
- Clean and disinfect the sample chamber surfaces, including the workplate and the drain pan. Clean and disinfect all accessories.

Shut-down

Interrupting an operation

To interrupt a work process, the device is switched to the OFF mode.

1. Remove all samples from the safety cabinet and store them properly.
2. Remove accessories from the sample chamber and clean and disinfect them.
3. Clean and disinfect the sample chamber surfaces, the workplate, and the drain pan.
4. Switch the device to OFF mode by keeping the ON key depressed until the indicators go off (a dot in the right display segment remains as a voltage signal indicator).

Shutting the unit down

If the unit is not to be used or stored for an extended period of time, it must be completely decontaminated.



Decontamination measures!

To shut the device down, the sample chamber must be disinfected completely and the plenum, including the filters, must be sterilized using formaldehyde.

1. After the device has been decontaminated, close the front window completely.
2. Disconnect the device from the power supply system.

Cleaning and decontamination

NOTE

Before cleaning and UV disinfection the covers of the UV lamps must be removed and afterwards installed.

Decontamination procedure

Several procedures can be applied for decontaminating the safety cabinet. Which procedure is selected, depends on:

- the potential risk imminent in the agents,
- the degree of purity required by an experiment or by a work process.

Possible decontamination procedures:

Wipe/spray disinfection: is the standard disinfection procedure for cabinets used for microbiological experiments.

UV disinfection: is particularly suited as an intensifying additional disinfection after a wipe/spray disinfection.

Sterilization with steam: can be used for treating the removable stainless steel components. Examples of autoclavable components are the bezels of the UV lamps, the workplate or workplate segments and the armrests.

Disinfection with formaldehyde: can be performed if a sterile sample chamber is required for the work process. This sterilization procedure is mandatory:

- when filters are replaced,
- when the device is shut down,
- when the device is discarded.

Wipe/spray disinfection

The wipe/spray disinfection is performed in three stages:

- Predisinfection,
- cleaning,
- final disinfection.

Recommended disinfectants:**NOTE Compatibility**

Chloride-containing disinfectants may damage some surfaces; use only chloride-free disinfectants or a disinfectant with a low enough chloride content to have been proved harmless for stainless steel finishes! Disinfectants with an alcohol content of more than 70 % may cause embrittlement of plastic components after extended exposure. Use only disinfectants with a low alcohol content. When using a disinfectant with an alcohol content of more than 70 %, the release limit of 200 g within 2 hours must not be exceeded. Also suited are disinfectants based on quaternary ammonium compounds.

Predisinfection:

1. Remove all samples from the sample chamber and store them properly.
2. Remove accessories from the safety cabinet and disinfect them using the disinfection procedure recommended by the manufacturer.
3. The workplate and stainless steel components can be removed from the sample chamber and disinfected separately.
4. For predisinfection, spray disinfectant on all sample chamber surfaces or wipe the surfaces using disinfectant.
5. Do not remove the optional UV lamps from the sockets; wipe them thoroughly using a damp cloth.
6. Switch the device to work mode, move front window to the working position.
7. Allow disinfectant to react as recommended by manufacturer, then operate the safety cabinet for at least 15 to 20 minutes in the work mode so that released aerosols can be absorbed by the filters.

Cleaning:

1. Thoroughly remove dirt residues and deposits using a solution of tepid water and dishwashing agent.
2. Wipe the surfaces clean using a clean cloth and plenty of clear water.
3. Remove the cleaning liquid from the drain pan and wipe all sample chamber surfaces dry.

Final disinfection:

1. Again, spray disinfectant on all sample chamber surfaces or wipe the surfaces clean with disinfectant.
2. Allow disinfectant to react as recommended by manufacturer.

UV disinfection after a wipe/spray disinfection

A UV disinfection can be performed either by using the optional integral UV lamps or by using a mobile UV device. The run time of the routine can be preset with the operating panel.

NOTE

Before disinfection remove the UV side covers and replace them afterwards. Do not apply too much cleaning agent to the UV emitter box. The ground fault circuit interrupter may release.

UV disinfection using the integral UV lamps

Running the UV disinfection routine, see “Running UV Disinfection” on page 54.

Changing the UV disinfection time

Setting the run time for the UV disinfection, see “Setting UV Disinfection Cycle Time” on page 69

Disinfection with formaldehyde

NOTE Disinfection procedure

Disinfection with formaldehyde bears considerable risks, the procedure must only be performed by specially trained authorized service personnel and in accordance to national regulations.

A suitable disinfection procedure must be selected according to the scope of application of the safety cabinet.

One possible method based on EN 12469/2000 is described below.

To cover the spectrum of action A, B, C and D, it is necessary to use another method. Based on recommendations of the RKI (Robert Koch Institute), another disinfection procedure is described in the service manual.

Procedure in accordance to EN 12469 / 2000:

For gas disinfection, formaldehyde is evaporated in the sample chamber of the completely sealed cabinet. The quantity of the formaldehyde used depends on the sample chamber volume of the cabinet version to be disinfected (see “Technical data” on page 111). Per cubic meter of sample chamber volume, at least 5 g formaldehyde must be evaporated with 20 ml water (corresponds with 25 ml of a 20 % formaldehyde solution). The formaldehyde evaporates immediately when its boiling point is reached. The required reaction time is at least 6 hours.

After the required reaction time, the formaldehyde should be neutralized by evaporating a 25 % ammonium solution (10 ml per cubic meter of sample chamber volume).

NOTE

After the neutralization reaction time with ammonia, carry out check measurements and ventilate. Ventilation until the MAK value is reached: Formaldehyde concentration <0.3 ppm (Occupational Exposure Limits).

Ambient conditions and accessories:

The temperature at the cabinet location should be approx 21 °C, the relative humidity should be between 60 and 85 %. To evaporate the solution, a heating device with a container is required.

Cleaning the exterior surfaces

Wipe the exterior surfaces of the device clean using a solution of tepid water and commercial dishwasher solution. Then, wipe exterior surfaces dry using a soft, clean cloth.

Cleaning the front window

For cleaning the front window (and for disinfecting it using wipe disinfection), the front window can be closed and hinged.

This ensures a sufficiently large gap between the light dome and the front window upper edge so that the upper section of the window can be treated. Clean the front window using a commercially available window cleaning agent.

Cleaning the drain pan

Clean the drain pan using a solution of tepid water and commercial dishwasher.

1. Remove the working plates from the workspace.
2. Remove dirt residues and deposits thoroughly.
3. Wipe the drain pan clean using a clean cloth and plenty of clear water.
4. Remove the cleaning liquid from the drain pan and wipe the drain pan surfaces thoroughly clean.

NOTE Material residues

After cleaning, make sure that all cleaning materials have been removed completely from the drain pan.

5. Reinstall the working plates.

Maintenance

Inspection

The annual inspection comprises the following checks:

- Electrical safety in accordance with national regulations.
- Functional test of the device.
- Checking all components for possible damage.
- Checking the filter state.

NOTE Perforated plate

The Perforated plate at the blanket of the sample chamber serves for the protection of the downflow filter and prevents refluxing. While scanning the filter surface for leak test the perforated plate must be built-in.

- Checking the airflow conditions.
- Repeat test in accordance with applicable standard (EN 12469:2000, NSF/ANSI 49 or other).

Service

HEPA filters:

As the filter replacement is an interference with the safety system of the device, filters must only be replaced by Thermo Electron LED or by adequately trained and authorized service personnel.

NOTE Filter change

Before filters are replaced the disinfection with formaldehyde is mandatory. After the filter replacement, a repeat test must be performed in accordance with applicable standard (EN 12469:2000, NSF/ANSI 49 or other.

UV lamps



Before replacing the UV lamps disconnect the unit from the power supply.

The UV lamps should be replaced after 8000 operating hours:

1. Remove cover from lamp housing. The cover is only pushed onto the lamp casing and may be pulled off easily.
2. Rotate the lamp in the socket so that the lamp contacts can be removed from the groove in the socket.
3. Insert the new lamp into the socket and rotate until the contacts engage.
4. Push the cover onto the lamp casing.

Sample chamber illumination

The tubes are installed in the front cover bezel.

1. Remove the bezel retaining screws and the bezel.
2. The tubes are retained by rotatable sockets. Rotate the tube carefully to the removal position and remove it from the socket.
3. Insert the replacement tube and rotate it to the working position.
4. Reinstall the bezel and secure it with the screws.

Replacing the front cover seal

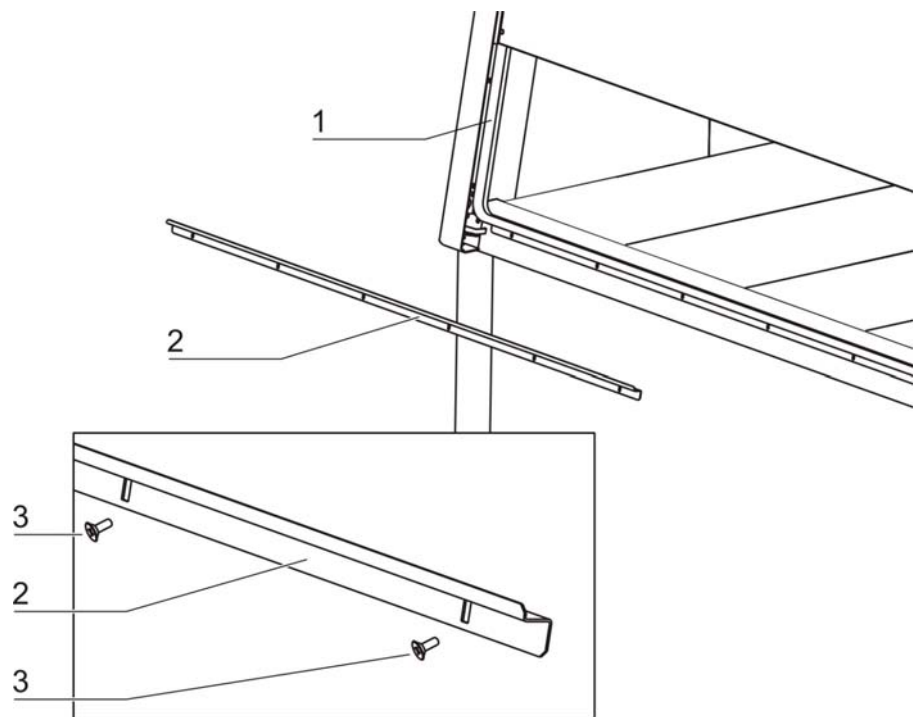

Figure 101 Replacing the front cover seal

When the front cover seal shows visible sign of wear, the seal must be replaced. The sealing is slipped onto the housing frame and secured by an additional retaining strip at the lower edge of the workspace opening.

1. Lower the front window completely and open the front cover.
2. Remove the retaining screws [3] and remove the retaining strip [2].
3. Remove the seal [1] from the housing frame retaining lip.
4. Slip the groove of the new seal onto the housing frame retaining lip and push it on so that the seal fits evenly along the entire sealing surface.
5. Secure the retaining strip with the screws.

Exchanging SmartPorts



Contamination!

There is a risk of contamination for users and the product itself. In order to prevent contaminated particles escaping from the workspace, the unit must be switched on in order to exchange the SmartPorts.

The SmartPorts are removed inwards into the workspace. Prior to replacement, all work in the workspace must be finished.

1. Before replacing the SmartPorts, open the front window. Doing so will produce an alarm to indicate that there is a potentially unsafe operating condition.
2. Before replacing the SmartPorts, disinfect the workspace, front window, as well as the inner and outer compartment walls.
3. First remove the inner grommet of the SmartPort in the workspace inwards from the side panel opening.
4. Disinfect the grommet in the workspace and disinfect the inner compartment walls.
5. Insert new inner grommet in the side panel opening from the inside.
6. Then remove the outer grommet of the SmartPort in the workspace inwards from the side panel opening.
7. Place the removed grommet in the workspace and disinfect.
8. Disinfect the outer compartment walls.
9. Insert new outer grommet in the side panel opening from the outside.
10. Safely discard used disinfected grommets.

Retrofitting and repairs

External communication systems, e.g. failure report systems or components for supplying media such as gas solenoid valves can be retrofitted and integrated into the device control.

NOTE Repairs

All retrofitting and repair work are interferences with the safety system of the unit. Particularly modifications to the filter system and resulting changes of the airflow may impair personal and material protection. Such work must be carried out only by authorized service personnel.

Disposal

Disposal procedure

Discarded cabinets or unit components contain reusable materials. All components with the exception of the HEPA filters can be disposed of after having been thoroughly decontaminated. The HEPA filters must be disposed of in accordance with the applicable national and state regulations for special solid waste.



Contamination hazard!

As the device can be used for processing and treating infectious substances, it may be contaminated. Prior to disposal, the complete device with filters must be decontaminated by performing a formaldehyde sterilization!



Recyclable materials!

Component	Material
Thermal insulation components	Polystyrene foam, EPS/PPS compound
Printed circuit boards	Enclosed electrical components coated with various plastics, mounted on epoxy resin-bound boards.
Plastic components, general	Note material labeling
Exterior housing	Steel, painted
Device backpanel	Stainless steel/steel, painted
Front cover seal	EMPP
Front window, side windows	Multi-layer safety glass
Operating panel and indicator foil	Polyethylene, Polyester
Workplates	Stainless steel
UV bezels	Stainless steel
Armrests	Stainless steel
Rechargeable battery (safety feature: Lower Front Window)	Nickel/metal hydrid

WEEE Conformity:

This product is required to comply with the European Union's Waste Electrical & Electronic Equipment (WEEE) Directive 2012/19/EU. It is marked with the following symbol:



Thermo Electron has contracted with one or more recycling/disposal companies in each EU Member State, and this product should be disposed of or recycled through them. Further information on Thermo Fisher Scientific's compliance with these Directives.

Technical data

Dimensions					
HERAsafe 2030i		230 V			
		0.9	1.2	1.5	1.8
Exterior dimensions					
Width	mm/inches	1000/39.4	1300/51.2	1600/63.0	1900/74.8
Depth	mm/inches	800/31.5			
Height	mm/inches	1536/605 (TÜV/LNE Version)			
Interior dimensions					
Width	mm/inches	900/35.4	1200/47.2	1500/59.1	1800/70.9
Depth	mm/inches	627/24.7			
Height	mm/inches	780/30.7			
Front window					
Working position	mm/inches	~200 / 250			
Max. opening	mm/inches	780			
Working area height					
seat position	mm/inches	750/29.5			
heightable	mm/inches	750/29.5 - 950/37.4			
Stand height					
	mm/inches	680/26.8 - 880/34.6			
Unit height with stand					
	mm/inches	2216/87 - max. 2416/95			
Side wall feed throughs					
Diameter	mm/inches	21.3/0.84			
Distance lower edge	mm/inches	135/5.3			
Distance from the rear wall					
Bushing 1	mm/inches	153.5/6			
Bushing 2	mm/inches	243.5/9.6			
SmartPort	mm/inches	198.5/7.8			

Optional media connections in the interior - rear wall

HERAsafe 2030i		0.9	1.2	1.5	1.8
Diameter	inch	R 3/8	R 3/8	R 3/8	R 3/8
Outer distance left					
Connection 1	mm/inches	401/15.8	501/19.7	900.1/35.4	1050/41.3
Connection 2	mm/inches	301/11.8	401/15.8	800.1/31.5	950/37.4
Connection 3	mm/inches	201/7.9	301/11.8	700.1/27.6	850/33.5

Electrical Data					
HERAsafe 2030i		230 V			
		0.9	1.2	1.5	1.8
Voltage					
Rated voltage	V	1/N/PE AC - 50/60 Hz			
Blower voltage	V	48 V / DC			
Current					
Power consumption	A	7	7	9	9
Leakage current IEC1010, EN 61010	mA	< 3,5			
Motherboard fusing	A	2 x T 16 A			
Outlet fusing	A	2 x T 5 A			
On-site fusing	A	Circuit breaker B 16 / Fuse T 16 A			
Power					
Power input max.	W	1675	1675	2010	2010
Protection					
Protection class		I			
Protection type		IP 20			
Overvoltage category (IEC 1010, EN 61010)		II			
Contamination degree (IEC 1010, EN 61010)		2			
Connecting lines					
Connecting lines		cable (2.5 or 5 m/8.2 or 16.4 ft)			

Pressure					
HERAsafe 2030i		0.9	1.2	1.5	1.8
Pressure media valves	bar/psi	max. 6/87			

Volume, weights, and loads					
HERAsafe 2030i		230 V			
		0.9	1.2	1.5	1.8
Volume					
Volume, weights, and loads	m ³ /cf	1,1/39	1,4/49	1,7/60	2,1/74
Floorpan	l/cf	30/1	40/1.4	50/1.7	60/2.1
Weights					
Cabinet	kg/lbs	170/375	200/441	230	280
Stand AFS 1	kg/lbs	26/57	26/57	27/60	27/60
Stand AFS 2	kg/lbs	30/66	30/66	31/68	31/68
Loads					
Max. load per working area module	kg/lbs	25/55			
Max. load on overall working area	kg/lbs	50/110	75/165	75/165	75/165

Airflow system					
HERAsafe 2030i		230 V			
		0.9	1.2	1.5	1.8
Airflow velocities					
Inflow	m/s / FPM	0,45 / 88.6			
Downflow	m/s / FPM	0,32 / 63			
Air volume					
200 mm / 8" access opening					
Overall volume flow	m³/h / CFM	918 / 540	1225 / 720	1530 / 900	1836 / 1080
Downflow volume flow	m³/h / CFM	622 / 366	830 / 488	1037 / 610	1244 / 732
Exhaust air volume flow	m³/h / CFM	296 / 174	395 / 232	493 / 290	592 / 348
250 mm / 10" access opening					
Overall volume flow	m³/h / CFM	992 / 584	1324 / 779	1654 / 973	1985 / 1168
Downflow volume flow	m³/h / CFM	622 / 366	830 / 488	1037 / 610	1244 / 732
Exhaust air volume flow	m³/h / CFM	370 / 218	494 / 291	617 / 363	741 / 436

Filter					
HERAsafe 2030i		0.9	1.2	1.5	1.8
Type		HEPA (H 14 nach DIN EN 1822)			
Material		Glas fiber fleece			
Separability in MPPS	%	99,995			
Separability at 0.3 µm particle size	%	99,999			
Downflow					
Width	mm/inches	915/36	1220/48	1525	1830/72
Depth	mm/inches	457/18			
Height	mm/inches	93/3.7			
Exhaust					
Width	mm/inches	457/18	610/24		915/36
Depth	mm/inches	457/18	457/18		457/18
Height	mm/inches	117/4.6	117/4.6		117/4.6

Ambient conditions					
HERAsafe 2030i		230 V			
		0.9	1.2	1.5	1.8
Temperature					
Max. ambient temperature during operation	°C / °F	40 / 104			
Min. ambient temperature during operation	°C / °F	10 / 50			
Humidity					
Max. humidity / operation	% r.H.	90			
Max. gumidity / storage	% r.H.	90			
Heat dissipation to environment					
200 mm / 8" access opening					
Room temperature 20 °C	kJ/s / BTU/hr	0,13 / 454	0,15 / 522	0,22 / 740	0,25 / 856
250 mm / 10" access opening					
Room temperature 20 °C	kJ/s / BTU/hr	0,16 / 529	0,18 / 597	0,24 / 819	0,3 / 1024
Room temperature rise					
Above room temperature with window closed	°K	< 2			
Ergonomics					
Noise level	dB(A)	57	57	57	57
		The noise level was determined in accordance with EN ISO 3744. The sound pressure level was measured at a distance of 1 m in front of the working opening. The measurement uncertainty is within a range of ± 2 dB .			

Device log

Device type:		Part number:	
Serial number:		Service number:	
Location:		Operator's note:	
Work carried out	Notes	Date	Signature

Certificate of decontamination

Invoice recipient / Customer no.:				Location / Forwarding address:			
Year of manufacturer:	KC:	ST:	Name of technician:		Appointed date:		
order date:	Ordered by:	Order no.:					
Type of device:			ID no. / Order no.:		Operating hours:		
Equipment no.:	Factory no.:	Service device no.:	Date of delivery:	Date of start-up:	Customer inventory no.:		
Certificate of decontamination							
<p>Dear customer,</p> <p>when using biological and chemical agents within and outside of devices, hazards to the health of the operating personnel may be present and contamination of the surroundings of the device may occur when service or repair works are carried out. Within the scope of national and international legal regulations, such as</p> <ul style="list-style-type: none"> - responsibility of a company for the protection of its employees, - responsibility of the operator for the operational safety of devices, <p>all possible hazards must absolutely be prevented. Prior to any calibration, service, and repair works, prior to any relocation of a device, and prior to the shut-down of a device, the device must be decontaminated, disinfected, and cleaned as required by the work to be carried out. Therefore, we ask you to fill in this certificate of decontamination before you start with the required work.</p> <p>Yours sincerely</p> <p>Thermo Electron LED GmbH</p>							
Works to be carried out (please mark where applicable)							
Service	<input type="checkbox"/>	Filter replacement	<input type="checkbox"/>				
Repair	<input type="checkbox"/>	Relocation	<input type="checkbox"/>				
Calibration	<input type="checkbox"/>	Transport	<input type="checkbox"/>				
Declaration of possible contamination (please mark where applicable)							
The device is clear of biological material	<input type="checkbox"/>	The device is clear of dangerous chemical substances	<input type="checkbox"/>				
The device is clear of radioactivity	<input type="checkbox"/>	The device is clear of other dangerous substances	<input type="checkbox"/>				
The device is clear of cytostatic agents	<input type="checkbox"/>						
Certification:							
<p>Prior to carrying out the required work, we have decontaminated, disinfected, and cleaned the device as described in the operating instructions of the device and in accordance with nationally applicable regulations. The device does not present any hazards.</p>							
Note:							
Date, legally binding signature, stamp							

Find out more at [thermofisher.com](https://www.thermofisher.com)

thermoscientific