

DYNEO™ DD



Heating immersion circulators, heating circulators with open baths, refrigerated circulators

Original operating manual

1.950.1300.en.V08

09/2023

Legal

JULABO GmbH
Gerhard-Juchheim-Strasse 1
77960 Seelbach / Germany
Tel.: +49 7823 51-0
Fax: +49 7823 2491
Info.de@julabo.com
www.julabo.com

The content of this operating manual is protected by copyright. Information, including texts, images, and other contents may not be reproduced, distributed, transmitted, stored or otherwise used in any form without prior explicit written consent.

Illustrations in this operating manual are for illustrative purposes and are not necessarily displayed to scale.

1	Foreword	7
2	About this manual	8
2.1	Original JULABO spare parts	8
2.2	Accessories	8
2.3	Warnings	9
2.4	Symbols used	10
3	Intended use	11
4	Safety	12
4.1	Safety instructions	12
4.2	Safety symbols	14
4.3	Safety function	15
5	Product description	16
5.1	Product overview	16
5.2	Function description	16
5.3	Operating and functional elements	17
5.4	Interfaces	18
5.4.1	Insulation requirements for the connection of external equipment	18
5.4.2	Connection of Pt100 temperature sensor	18
5.4.3	RS232 interface (optional)	19
5.4.4	USB-A interface	20
5.5	Analog interfaces (option)	20
5.5.1	Alarm output	21
5.5.2	REG/EPROG socket	22
5.5.3	Standby input	22
5.6	Operating interface	23
5.6.1	Operation with the central controller	24
5.6.2	Softkeys and status icons	24
5.7	Alarm messages	25
5.8	Operator Messages	26
5.9	Main menu	27
5.9.1	Settings menu	27
5.9.2	Record data menu	27

5.9.3	Thermodynamics menu.....	28
5.9.4	Adjust safety menu.....	28
5.9.5	Programmer menu	28
5.9.6	Menu Connect unit	28
5.9.7	Service menu	29
5.9.8	Install unit menu	29
5.10	Technical data.....	30
5.10.1	Material of parts that come into contact with the medium.....	32
5.10.2	Technical data for refrigerated circulators	33
5.10.3	Bath fluids.....	40
5.10.4	Hoses	41
6	Transport and installation.....	42
6.1	Transporting the device	42
6.2	Install the device at the operating location	43
7	Initial operation.....	44
7.1	Mounting the circulator	44
7.1.1	Mount heating or refrigerated circulator	44
7.2	Connect the device to the power supply	45
7.2.1	Connect bridge mounted or heating circulator	45
7.2.2	Connect refrigerated circulator	46
7.3	Connecting an external system	47
7.3.1	Connect an external system with screw connections	48
7.3.2	Connect an external system with barbed fittings.....	50
7.4	Switch on the device and set the language.....	51
7.5	Set high temperature safety function.....	51
7.6	Fill device.....	52
7.7	Set up power supply for the refrigerated circulator	53
7.8	Adjusting the flow of the bath fluid.....	53
7.9	Set chiller mode.....	54
7.10	Set limit values	55
7.10.1	Set temperature warning limits.....	55
7.10.2	Adjusting setpoint limits.....	55
7.10.3	Adjusting actual value limits	56
7.10.4	Band limit for external control.....	56
7.10.5	Setting band limit.....	57

7.11	Connect external temperature sensor	57
8	Operation.....	58
8.1	Switch on the unit.....	58
8.2	Switch off the unit.....	58
8.3	Start temperature control application	58
8.4	Basic settings	59
8.4.1	Set language	59
8.4.2	Set date and time	59
8.4.3	Activate autostart function.....	60
8.4.4	Set physical units	60
8.4.5	Set key tones.....	60
8.5	Record data.....	61
8.5.1	Record measurement data.....	61
8.5.2	Reading out blackbox data.....	61
8.5.3	Displaying alarm memory.....	62
8.6	Thermodynamics.....	63
8.6.1	Control parameter	63
8.6.2	Optimizing temperature curves	64
8.6.3	Adjust controller	65
8.6.4	Limit cooling capacity and heating capacity.....	65
8.6.5	Adjust pump	65
8.7	Remote control device.....	66
8.7.1	Remote control device using USB interface	66
8.7.2	Set RS232 interface parameters.....	67
8.7.3	Remote control device using RS232 interface.....	67
8.7.4	Set EPROG input	68
8.7.5	Set external setpoint values.....	68
8.7.6	Set up actuating variable.....	69
8.7.7	Request device status.....	69
8.8	Working with the programmer	69
8.8.1	Setting the timer	70
8.8.2	Creating and editing a temperature control profile.....	70
8.8.3	Delete temperature control profile.....	71
8.8.4	Set profile timer	72
8.8.5	Profile series setup.....	72

8.9	Configure signal outputs.....	73
8.9.1	Configure signal outputs of the REG/EPROG plug.....	73
8.10	Activating stand-by input	74
8.11	Adjusting the temperature sensor (ATC).....	74
8.11.1	Adjust internal temperature sensor	74
8.11.2	Adjust external temperature sensor	75
8.12	Device Reset	76
9	Maintenance	77
9.1	Replace detachable power cord.....	77
9.2	Check safety symbols.....	77
9.3	Check the functionality of high temperature cut-off.....	77
9.4	Test the low liquid level safety function	78
9.5	Emptying.....	78
9.6	Clean device.....	79
9.7	Device storage.....	80
9.8	Technical Service.....	80
9.9	Warranty	81
10	Disposal.....	82
10.1	Device disposal	82
11	EC Declaration of Conformity	83
12	UK Declaration of Conformity	84
13	Appendix	85
13.1	Interface commands	85
13.1.1	IN commands	85
13.1.2	OUT commands	88
13.1.3	Status commands.....	90
13.1.4	Status messages.....	90
13.2	Alarms and Warnings	91

1 Foreword

Congratulations!

You have made an excellent choice.

JULABO would like to thank you for the trust you have placed in our company and products.

This operating manual will help you become acquainted with the use of our units. Read the operating manual carefully. Keep the operating manual handy at all times.

2 About this manual

This manual is intended for the equipment specified on the cover page.



NOTE

Observe the safety instructions!

Read the Safety section of this manual before using the equipment for the first time.

2.1 Original JULABO spare parts

Hassle-free continuous operation and safety also depend on the quality of the spare parts used.

Only original JULABO spare parts guarantee the highest possible quality and safety. Original JULABO spare parts are available directly from JULABO or your specialist dealer.

Please note that JULABO cannot provide a warranty service if non-original JULABO spare parts are used.

2.2 Accessories





JULABO offers a wide range of accessories for the devices. Accessories are not described in this manual.

The complete range of accessories for the devices described in this manual can be found on our website **www.julabo.com**. Use the Search function on the website.

2.3 Warnings

The manual contains warnings to increase safety when using the device. Warnings must always be observed.

A warning sign displayed in signal color precedes the signal word. The signal word, highlighted in color, specifies the severity of the hazard.

	<p><i>DANGER</i></p> <p>This signal word designates a danger with a high level of risk which, if it not prevented, will result in death or serious injuries.</p>
	<p><i>WARNING</i></p> <p>This signal word designates a danger with a medium level of risk which, if it not prevented, may result in death or serious injuries.</p>
	<p><i>CAUTION</i></p> <p>This signal word designates a danger with a low level of risk which, if it not prevented, may result in minor to moderate injuries.</p>
	<p><i>NOTE</i></p> <p>This signal word designates a possibly harmful situation. If it is not avoided, the system or objects in its vicinity may be damaged.</p>

2.4 Symbols used

Various symbols are used throughout this manual to aid reading comprehension. This list describes the symbols used.

- ✂ Tools needed for the following approach
- ▶ Prerequisite to be met for the following procedure
- 1. Numbered action steps
- ↪ Interim result for individual action steps
- 👉 Additional note for individual action steps
- ✓ Final result of a procedure
- <> Terms in angle brackets denote control menu
- [] Terms in square brackets denote keys, softkeys and buttons

3 Intended use

This section defines the purpose of the unit so that the operator can operate the unit safely and avoid misuse.

JULABO circulators are laboratory devices that are designed for temperature control applications with liquid media in a bath tank or with a cooling machine. An external loop circuit can be connected to the pump connectors so that the temperature of the bath media can be kept constant.

Only use the device if it is in technically perfect condition and only use it in accordance with its intended use. Be aware of safety issues or hazards and comply with the operating manual! In particular, always immediately rectify faults that could impair safety!

The circulators are not suitable for direct temperature control application of food, other consumables or pharmaceutical or other medical products.

The devices are not suitable for use in an explosive environment.

The devices are not intended for use in living areas. They may cause interference with radio reception.

4 Safety

4.1 Safety instructions

The unit is built in accordance with state of the art technology and recognized safety regulations. Despite this, its use may pose a risk to life and limb for the user or third parties.

Therefore, always read and observe the following safety instructions before using the product.

Hot surfaces!

The following parts and elements may become hot during operation:

- Bath fluid
- Heating element
- Bath lid
- Bath surface
- Connections for external application

Contact may cause severe burns or scalds to hands and arms, face and limbs.

- Keep sufficient distance from hot surfaces and fluids.
- Wear suitable protective gloves.

Electric shock from electrical system!

Touching damaged live parts can cause severe electric shocks and lead to injury or even death.

- Have damaged insulation and parts of the electrical system immediately repaired by JULABO service technicians or a qualified specialist workshop
- Immediately replace damaged power cords
- When connected with a mains plug, this mains plug must always be readily accessible

Refrigerants are harmful to health!

Refrigerants and their vapors are harmful to health. There is a suffocation risk in enclosed spaces.

- Do not touch or inhale refrigerants.
- Have damage to the refrigerant cycle repaired only by JULABO service technicians or qualified specialists.
- If refrigerant leaks, stop the device immediately and ventilate the room thoroughly.

Natural refrigerants are flammable!

The device contains flammable refrigerants. If there is a leak in the refrigerant cycle, a flammable concentration may form in the air and ignite or explode. This can result in serious injury or death.

- Use the required minimum room size for operating the device.
- Do not store any potential sources of ignition near the device.
- If refrigerant leaks, stop the device immediately and ventilate the room thoroughly.
- Have damage to the refrigerant cycle repaired only by JULABO service technicians or qualified specialists.
- Have maintenance work performed only by JULABO service technicians or qualified specialists.

Wear personal protective equipment!

Lacking or unsuitable personal protective equipment increases the risk of health damage and injury.

Personal protective equipment includes, for example:

- Work gloves
- Safety shoes
- Protective clothing
- Breathing protection
- Hearing protection
- Face and eye protection
- Specify and provide personal protective equipment for the respective application.
- Use only personal protective equipment that is in good condition and provides effective protection.
- Adapt personal protective equipment to the person, e.g., by size.

Keep safety symbols legible!

Safety symbols on the unit warn of dangers in hazardous areas and are an important part of the unit's safety equipment. Missing safety symbols increase the risk of injury to persons.

- Clean dirty safety symbols.
- Replace damaged and unrecognizable safety symbols immediately.





Maintenance and repair work!

Improper maintenance and repair work jeopardizes operational safety. This can result in serious injury or death.

- Only carry out work described in this operating manual. Switch off the unit and disconnect it from the power supply before carrying out any work.
- All other maintenance and repair work may only be carried out by a JULABO service technician or a qualified specialist workshop.

4.2 Safety symbols

There are safety symbols included with the device, which should be attached to the device before initial operation.

Safety symbols	Description
	Warning of a danger zone. Note operating manual
	Warning about hot surface
	Warning of cold surface
	Warning of a flammable liquid heat transfer medium
	Read operating manual before switching on

4.3 Safety function

Technical protective devices provide for safe operation. If a safety function is triggered, the operator is alerted with a message on the display and an acoustic signal.

Adjustable high temperature cut-off

The high temperature cut-off prevents overheating of the heater.

- If the measured temperature rises above the set protective temperature, an error message is shown on the display. The pump and heater are switched off. A restart is required.

Overheating protection

The overheating protection prevents overheating of the heater.

- The protection mechanism responds when a certain temperature difference between the working temperature sensor and the safety temperature sensor is exceeded. A warning message appears on the display. The heating capacity is limited.
- If the temperature difference persists for longer, an alarm message appears on the display and the temperature control application is switched off.

Low liquid level protection

A level switch recognizes when the bath fluid fill level in the bath tank is too low. The device has a two-stage warning system to prevent overheating of the heater or dry running of the pump.

- The low liquid level warning is triggered when the liquid level in the bath tank is about half the full level. A warning message appears on the display. The bath fluid should be topped up.
- The low liquid level alarm is triggered when the float reaches its lower limit stop. The device switches off the pump and heater. A continuous signal tone sounds. A warning message appears on the display. A restart is required.

5 Product description

5.1 Product overview

Circulators can be combined with various baths and cooling machines.

Heating immersion circulator



DYNEO DD Circulator

Heating circulator



Circulator with closed stainless steel bath tank. Example: DYNEO DD-BC6 for temperature control applications in the bath or externally

Refrigerated circulator



Circulator with cooling machine. Example: DYNEO DD-601F for standard temperature applications

5.2 Function description

This section describes the function of the device.

The circulator can be mounted on any bath tank with a volume up to 50 liters. The circulators are used for internal and external temperature control, and depending on the device combination and accessories used can work in a temperature range between -50°C and $+200^{\circ}\text{C}$.

When mounted on a bath tank the circulator is a heating circulator, when combined with a cooling machine it is a refrigerated circulator.

5.3 Operating and functional elements

The following figure shows the operating and functional elements and their position on the unit.

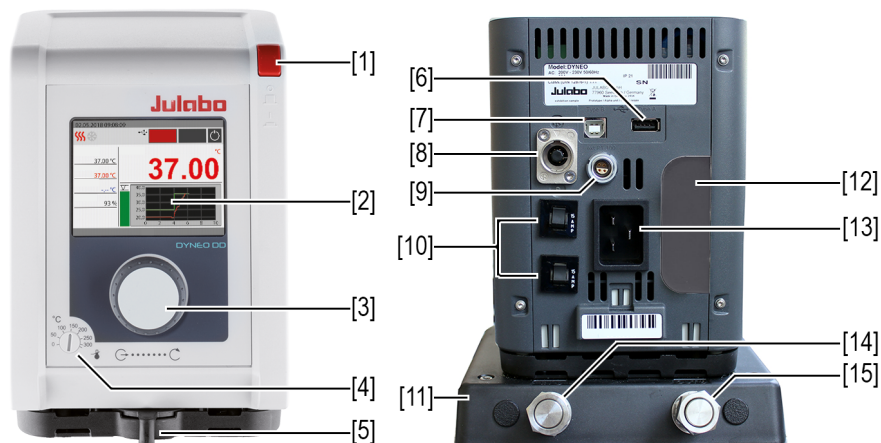

Control and function elements

1	Mains switch
2	Display
3	Central controller
4	High temperature cut-off setting
5	Internal/external flow direction setting
6	USB interface Type A
7	USB interface Type B
8	CAN plug for connection with a cooling machine
9	Interface for external temperature sensor
10	Mains fuse, resettable
11	Assembly frame with pump connections (not for heating immersion circulator)
12	Cover for optional interfaces
13	Mains connection
14	Runback pump connection
15	Supply pump connection

5.4 Interfaces

This section describes the electronic interfaces on the device.
 For safe operation, the interfaces must be operated according to their corresponding permissible specifications.

5.4.1 Insulation requirements for the connection of external equipment

External equipment connected to the thermostat must be reinforced or double insulated from the mains and the maximum voltages must be below the values of 30 VAC / 60 VDC.

Also note the maximum voltage information in the technical specifications for the individual interfaces.

5.4.2 Connection of Pt100 temperature sensor

The plug ext. Pt100 is used to connect an external Pt100 temperature sensor.
 The following section describes the wiring of the plug as well as the connection cable of the temperature sensor.

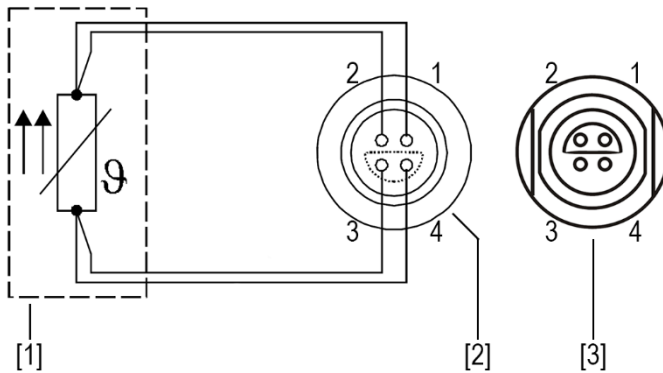

Connection of a external Pt100 temperature sensor

- [1] Temperature sensor Pt100
- [2] Plug, view of solder side
- [3] Connection socket on device

Pin	Signal
1	I+
2	U+
3	U-
4	I-

5.4.3 RS232 interface (optional)

The RS232 interface is a 9-pin D-Sub socket for connecting the device to a PC.

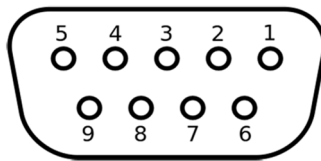

RS232 plug

RS232 interface pin assignment			
Pin 2	RxD receive data	Pin 7	RTS request to send
Pin 3	TxD transmit data	Pin 8	CTS clear to send
Pin 5	0 V signal GND		

Pins 1, 4, 6 and 9 are reserved. Do not use.

RS232 interface factory setting	
Parity	straight
Baud rate	4800 baud
Handshake	Hardware
Data bit	7
Stop bit	1

5.4.4 USB-A interface

USB sticks can be connected to the USB-A interface. This unit is capable of reading data from the USB stick as well as saving data to the USB stick.

Technical data for USB-A interface

Output voltage	5 VDC
Maximum current	500 mA

5.5 Analog interfaces (option)

The analogue interfaces are optional and installed ex works.



Slide-in module with analogue connections

- [1] Alarm output
- [2] REG/EPROG plug
- [3] Standby input

5.5.1 Alarm output

The alarm output is a potential-free changeover contact, through which an externally connected circuit can be switched.

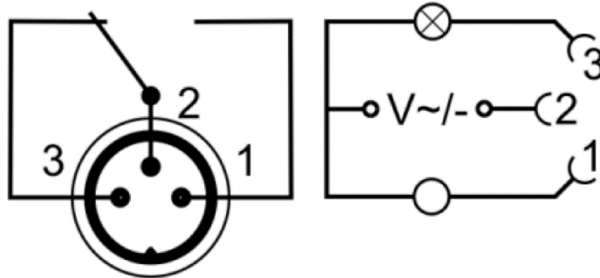

Alarm output diagram

In the **<Analog module>** menu, a defined state can be selected as the trigger for the **<Alarm output>**.

When the respective state is reached, pins 2 and 3 are connected:

- Standby
- Alarm
- Alarm + Standby

When the respective state is reached, pins 1 and 2 are connected:

- Standby/Inverse
- Alarm/Inverse
- Alarm + Standby/Inverse

Alarm output technical data	
Maximum switching capacity	30 W/25 VA
Maximum switching voltage	30 VDC/25 VAC
Maximum switching current	1 A

5.5.2 REG/EPROG socket

The REG/EPROG socket has three signal outputs and one signal input.

A signal transmitter connected to the programmer input can specify the setpoint temperature or performance as a variable. The input signal can be a voltage source or a current source.

The signal outputs can be used at the same time. Two of the three output channels are designed as voltage outputs, the third as a current output.

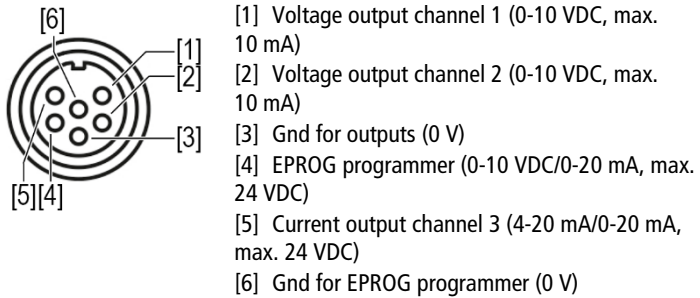

REG/EPROG socket diagram

5.5.3 Standby input

With the standby socket the device can be put in standby mode using an external signal transmitter.

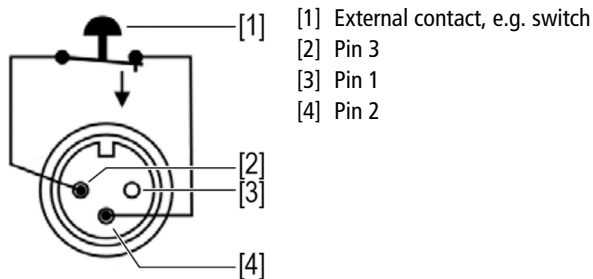

Standby socket diagram

5.6 Operating interface

The device is operated using the central controller. When it is switched on, the display shows the home screen. The **[Display]** softkey toggles between three different views of the home screen.

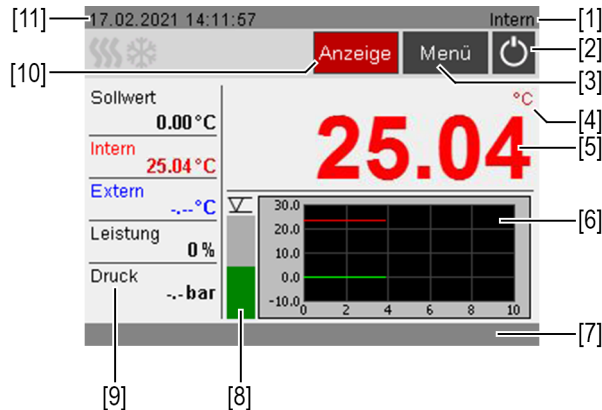

Home screen

- [1] Internal/external temperature control
- [2] Start/Stop
- [3] **[Menu]** softkey opens the <Main menu>
- [4] Temperature unit: Celsius/Fahrenheit
- [5] Display of current internal/external temperature, display off in standby mode
- [6] Temperature sequence setpoint temperature/current temperature internal and external
- [7] Status line for operator messages/alarms/warnings
- [8] Fluid level display
- [9] Display of current capacity parameters
- [10] **[Display]** softkey swaps home screen views
- [11] Date/time

5.6.1 Operation with the central controller

The central controller is used to control all menu functions and inputs on the user interface. Selected menus, softkeys or input fields are highlighted in red.

Turning:





- navigates between menus, buttons and input fields
- sets values





Pressing:

- opens menus
- actuates softkeys and buttons
- activates input fields and selected functions
- confirms an entry

5.6.2 Softkeys and status icons

This section describes the softkeys and status icons found on the operating interface.

Softkey	Function
	The [Start/Stop] softkey starts a temperature control application or stops an ongoing temperature control application
	The [Home] softkey calls up the Home screen
	Go back one menu level with the [Back] softkey
	The [Help] softkey calls up the Help menu
	The [Save] softkey saves entries

Symbol	Description
	Heating is active
	Cooling is active
	Alarm message
	Warning message

5.7 Alarm messages

Errors or disturbances are indicated on the Home screen by alarm messages or warnings. A help text is displayed by pressing the warning symbol with the central controller. Important error code descriptions can be found in the appendix. If you are unable to rectify a fault, contact Technical Service.

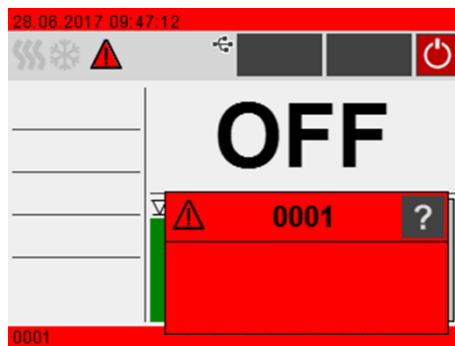

Display of alarm message

Alarm:

In the event of an alarm, the tempering process is stopped. The actuators are switched off. At the same time, a continuous acoustic signal sounds and an alarm message with a red background is shown on the display. The acoustic signal can be deactivated by pressing the central controller. The fault causing the alarm must be remedied. A restart is required.

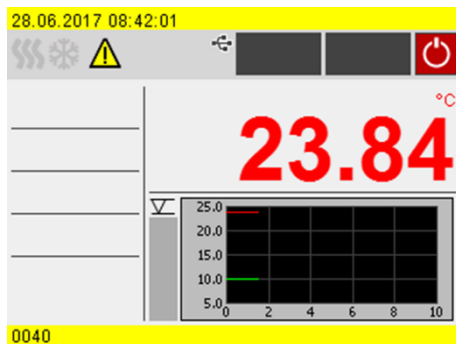

Display of warning message

Warning:

In the event of a warning, the tempering process is not interrupted. A warning message with a yellow background is display. A signal tone is emitted at intervals. The acoustic signal can be deactivated by pressing the central controller. If the underlying cause of the warning is remedied, the signal tone ceases. Depending on the cause, warnings may cease automatically after a period of time, e.g. when the device cools down.

5.8 Operator Messages

Operator messages are informal messages that inform the operator about status changes of the device.

Operator messages provide information about the operating states of individual units on the status line of the home screen. Status messages from a connected cooling machine are also displayed as operator messages.

5.9 Main menu

Bring up the Main menu using the **[Menu]** softkey on the home screen. The Main menu is divided into menu options, which respectively contain more submenus or in which settings can be specified. You can always get back to the home screen using the **[Home]** softkey.

The **<Main menu>** is divided into the following menu options:

- Settings
- Record data
- Thermodynamics
- Adjust safety
- Programmer
- Connect unit
- Service
- Install unit

5.9.1 Settings menu

In the menu **<Settings>** the fundamental device settings are specified.

- Set language
- Set date and time
- Enable/disable autostart
- Set physical units
- Enable/disable key tones
- Reading out the alarm memory

5.9.2 Record data menu

The device can record data on an external storage medium. The menu **<Record data>** defines the conditions for this and starts recording. The recorded data can be used for subsequent evaluation.

- Recording measurement data
- Reading out blackbox data

5.9.3 Thermodynamics menu

The control parameters for the temperature sequence are defined and the pump capacity is set in the menu **<Thermodynamics>**.

Adjust controller:

- Setting for the control parameters for internal or external control
- Definition of the control behavior
- Specification of the limit values for heating capacity and cooling capacity

Adjust pump:

- Setting for pump mode
- Setting for pump capacity

5.9.4 Adjust safety menu

In the menu **<Adjust safety>** limit values are set to define a range for safe process flow.

- Temperature limits: Setting for the upper and lower warning limits
- Setpoint limits: Setting for the upper and lower limits for temperature setpoint

5.9.5 Programmer menu

The **<Programmer>** menu is used to program temperature sequences, which can be called up according to definable rules.

- Timer: Setting for start time, duration and setpoint
- Profile timer: Timer function for individual profiles
- Profile series: Planning of individual profile series sequences
- Edit profile: Create, manage, import and export profiles

5.9.6 Menu Connect unit

The device can be connected with a PC and remote controlled using the USB interface or the optional RS232 interface. In addition to this, external programmers can also be connected via optional analog interfaces. In the menu **<Connect unit>** parameters for remote control mode can be set.

- Remote control
- Digital interfaces
- External setpoint
- Analog interfaces

- Actuating variable
- Start up behavior

5.9.7 Service menu

The menu **<Service>** is reserved for JULABO service technicians and password protected.

5.9.8 Install unit menu

In the menu **<Install unit>** several basic settings are specified. Depending on the device configuration, not all menu functions may be available.

- Adjust external temperature sensor
- Import and export device settings
- Reset unit
- Set power supply
- Set chiller mode

5.10 Technical data

Performance specifications measured in accordance with DIN12876. Cooling capacities up to 20°C measured with ethanol; over 20°C with thermal oil unless specified otherwise. Performance specifications apply at an ambient temperature of 20°C. Performance values may differ with other bath fluids.

Grouping of the device acc. to CISPR 11:

- The device is an ISM device of group 1, which uses high frequency for internal purposes
- Class A: Use in an industrial electromagnetic environment

In accordance with IEC 61010-1, the device is designed for safe operation under the following ambient conditions:

- Indoor use
- Altitude up to 2000 m above sea level
- Ambient temperature +5 ... +40°C
- Maximum relative humidity 80% for temperatures up to 31°C, decreasing linearly down to 50% relative humidity at 40°C
- Mains voltage fluctuations up to $\pm 10\%$ of the nominal voltage permissible if not otherwise specified
- Pollution degree level 2

Protection class according to EN 60 529:

- Protection class IP21

DYNEO DD**Temperature control application**

Working temperature range	°C	+20 ... +200			
Temperature stability	°C	±0.01			
Temperature resolution	°C	0.01			
Temperature control		PID3			
Temperature setting		Digital			
ATC sensor adjustment		3-point adjustment			

Pump

Volume flow	l/min	8 ... 27			
Supply pressure	bar	0.1 ... 0.7			
Maximum viscosity	cSt	50			

Dimensions

Dimensions (W x D x H)	cm	13.2 x 16.0 x 35.5			
Immersion depth	cm	16.0			
Weight	kg	2.5			

Display

Display		3.5" TFT display			
---------	--	------------------	--	--	--

Performance data

Mains connection		100-115 V 50/60 Hz		200-230 V 50/60 Hz	
		100 V 50/60 Hz	115 V 50/60 Hz	200 V 50/60 Hz	230 V 50/60 Hz
Current consumption	A	10	11	9	10
Heating capacity	kW	0.8	1.0	1.5	2.0
Mains fuse, resettable	A	15			

5.10.1 Material of parts that come into contact with the medium

The table lists parts that could come into contact with the bath fluid as well as the material that the parts are made of. This data can be used to check the compatibility of the parts with the bath fluid used.

Parts that come into contact with the medium	Material
Motor	1.4301
Motor shaft	1.4404
Pump	PPS
Heating element	1.4404/316L
Inbuilt temperature sensor Pt100	1.4571
Connection of temperature sensor	1.4301
Float	1.4401
Float pipe	1.4571
Hose olive	1.4301
Single-ear clamp	1.4301
Hose	FPM/FKM

5.10.2 Technical data for refrigerated circulators

This section lists the technical data of the refrigerated circulator.

Technical data		DYNEO DD-200F					
Working temperature range	°C	-20 ... +200					
Cooling capacity	°C	+20	+10	0	-10	-20	
	kW	0.20	0.17	0.15	0.10	0.02	
Refrigerant		R134A					
Dimensions							
Dimensions (W x D x H)	cm	23 x 39 x 65					
Usable bath opening	cm	13 x 15					
Bath depth	cm	15					
Volumes min. ... max.	l	3.0 ... 4.0					
Weight	kg	25.7					

Technical data		DYNEO DD-201F					
Working temperature range	°C	-20 ... +200					
Cooling capacity	°C	+20	+10	0	-10	-20	
	kW	0.20	0.17	0.15	0.10	0.02	
Refrigerant		R134A					
Dimensions							
Dimensions (W x D x H)	cm	44 x 41 x 44					
Usable bath opening	cm	13 x 15					
Bath depth	cm	15					
Volumes min. ... max.	l	3.0 ... 4.0					
Weight	kg	24.7					

Technical data		DYNEO DD-300F					
Working temperature range	°C	-25 ... +200					
Cooling capacity	°C	+20	+10	0	-10	-20	
	kW	0.30	0.30	0.27	0.19	0.08	
Refrigerant		R134A					
Dimensions							
Dimensions (W x D x H)	cm	24 x 42 x 66					
Usable bath opening	cm	13 x 15					
Bath depth	cm	15					
Volumes min. ... max.	l	3.0 ... 4.0					
Weight	kg	27.7					

Technical data		DYNEO DD-310F					
Working temperature range	°C	-30... +200					
Cooling capacity	°C	+20	0	-10	-20	-30	
	kW	0.30	0.27	0.21	0.12	0.02	
Refrigerants		R449A, R290					
Dimensions							
Dimensions (W x D x H)	cm	23 x 40 x 65					
Usable bath opening	cm	13 x 15					
Bath depth	cm	15					
Volumes min. ... max.	l	3.0 ... 4.0					
Weight	kg	27.4					

at 200-230 V / 50/60 Hz permissible voltage deviation is ± 5 %

Technical data		DYNEO DD-449F					
Working temperature range	°C	-30 ... +200					
Cooling capacity	°C	+20	0	-10	-20	-30	
	kW	0.44	0.35	0.27	0.20	0.06	
Refrigerants		R290					
Dimensions							
Dimensions (W x D x H)	cm	39 x 62 x 75					
Usable bath opening	cm	28 x 35					
Bath depth	cm	20					
Volumes min. ... max.	l	21.0 ... 30.0					
Weight	kg	39.5					

Technical data		DYNEO DD-450F					
Working temperature range	°C	-30 ... +200					
Cooling capacity	°C	+20	0	-10	-20	-30	
	kW	0.44	0.37	0.27	0.16	0.06	
Refrigerants		R449A, R290					
Dimensions							
Dimensions (W x D x H)	cm	23 x 40 x 65					
Usable bath opening	cm	13 x 15					
Bath depth	cm	15					
Volumes min. ... max.	l	3.0 ... 4.0					
Weight	kg	27.4					

at 200-230 V / 50/60 Hz permissible voltage deviation is $\pm 5\%$

Technical data		DYNEO DD-600F					
Working temperature range	°C	-35 ... +200					
Cooling capacity	°C	+20	+10	0	-10	-20	-30
R452A*	kW	0.60	0.54	0.50	0.33	0.19	0.07
R449A	kW	0.60	0.54	0.44	0.27	0.16	0.04
Refrigerant		R449A, R452A*					
Dimensions							
Dimensions (W x D x H)	cm	33 x 47 x 69					
Usable bath opening	cm	22 x 15					
Bath depth	cm	15					
Volumes min. ... max.	l	5.0 ... 7.5					
Weight	kg	35.7					

at 200-230 V 50/60 Hz permissible voltage deviation $\pm 5\%$,

* at 100 V 50/60 Hz

Technical data		DYNEO DD-601F					
Working temperature range	°C	-35 ... +200					
Cooling capacity	°C	+20	+10	0	-10	-20	-30
R452A	kW	0.60	0.54	0.50	0.33	0.19	0.07
R449A	kW	0.60	0.54	0.44	0.27	0.16	0.04
Refrigerant		R449A, R452A*					
Dimensions							
Dimensions (W x D x H)	cm	33 x 47 x 74					
Usable bath opening	cm	22 x 15					
Bath depth	cm	20					
Volumes min. ... max.	l	8.0 ... 10.0					
Weight	kg	38.2					

at 200-230 V 50/60 Hz permissible voltage deviation $\pm 5\%$,

* at 100 V 50/60 Hz

Technical data		DYNEO DD-800F					
Working temperature range	°C	-40 ... +200					
Cooling capacity	°C	+20	0	-20	-30	-40	
	kW	0.84	0.74	0.39	0.26	0.12	
Refrigerant		R1270					
Dimensions							
Dimensions (W x D x H)	cm	33 x 47 x 70					
Usable bath opening	cm	18 x 13					
Bath depth	cm	15					
Volumes min. ... max.	l	5.0 ... 7.5					
Weight	kg	42.0					

Technical data		DYNEO DD-1000F					
Working temperature range	°C	-50 ... +200					
Cooling capacity	°C	+20	0	-10	-20	-30	-40
	kW	1.00	0.96	0.73	0.51	0.25	0.11
Refrigerant		R449A					
Dimensions							
Dimensions (W x D x H)	cm	42 x 49 x 70					
Usable bath opening	cm	18 x 13					
Bath depth	cm	15					
Volumes min. ... max.	l	5.0 ... 7.5					
Weight	kg	51.2					

at 200-230 V / 50/60 Hz permissible voltage deviation is $\pm 5\%$

Technical data		DYNEO DD-1001F					
Working temperature range	°C	-38... +100					
Cooling capacity	°C	+20	+10	0	-10	-20	-30
	kW	1.00	0.95	0.85	0.60	0.32	0.12
Refrigerant		R449A					
Dimensions							
Dimensions (W x D x H)	cm	45 x 64 x 95					
Usable bath opening	cm	35 x 41					
Bath depth	cm	30					
Volumes min. ... max.	l	42.0 ... 56.0					
Weight	kg	73.7					

Technical data		DYNEO DD-1200F					
Working temperature range	°C	-50 ... +200					
Cooling capacity	°C	+20	0	-20	-30	-40	
	kW	1.24	1.09	0.62	0.39	0.22	
Refrigerant		R1270					
Dimensions							
Dimensions (W x D x H)	cm	33 x 47 x 70					
Usable bath opening	cm	18 x 13					
Bath depth	cm	15					
Volumes min. ... max.	l	5.0 ... 7.5					
Weight	kg	42.0					

Technical data		DYNEO DD-1000FW					
Working temperature range	°C	-50... +200					
Cooling capacity	°C	+20	0	-10	-20	-30	-40
	kW	1.00	0.96	0.73	0.51	0.25	0.11
Refrigerant		R449A					
Dimensions							
Dimensions (W x D x H)	cm	42 x 49 x 70					
Usable bath opening	cm	18 x 13					
Bath depth	cm	15					
Volumes min. ... max.	l	5.0 ... 7.5					
Weight	kg	51.2					

at 200-230 V / 50/60 Hz permissible voltage deviation is ± 5 %

5.10.3 Bath fluids

The most important criterion when selecting the bath fluid is the working temperature range in which the application is operated.

- Selection of the bath fluid must ensure that the flash point is never exceeded when it comes into contact with the ambient air.
- Recommended bath fluids and further information can be found on our website



WARNING

Risk of burns due to Flammable heat transfer medium

If a flammable heat transfer medium is used, it may ignite and cause serious burns when it comes into contact with skin.

- Ensure all ventilation openings are not obstructed
- No smoking! No flame!
- Do not use electrical parts which can produce spark when operating around the equipment and the application system
- Drain and recover the liquid when the equipment idles, if the liquid heat transfer medium is used with an open bath tank and if it is highly volatile at ambient temperature
- Under normal and single-fault conditions, the surface temperature of flammable liquids must not reach the flash point of the liquid. Set a safety value that is at least 25 K below the flash point of the bath fluid being used. Set the temperature safety function as describes in Chapter "Set high temperature safety function"
- Affix a label on the equipment with symbol  if a flammable liquid heat transfer medium is to be used



NOTE

No liability accepted for usage of bath fluids that are not suitable!

Unsuitable bath fluids that are not approved by JULABO can damage the water bath.

- Use bath fluids that are recommended by JULABO
- Before filling, check the parts that are in contact with the medium for compatibility with the bath fluid
- Do not exceed the maximum permissible viscosity during operation
- Consult JULABO before using a bath fluid other than the recommended one

**NOTE****Material damage caused by freezing water!**

Freezing water can damage the device and the sample.

- When using water as the tempering fluid, do not temper below 5°C

Water as bath fluid

- Water can be used for working temperatures from +5 °C to +90 °C
- Recommended: Use only ultrapure or distilled water.
- When using ultrapure or distilled water, add 0.1 g Na₂CO₃ per liter of water.

5.10.4 Hoses

Hoses for connection of an external system must suit the working temperature range and the respective temperature control application.

Hoses for every area of application can be found on our website.

Hoses must meet the following requirements:

- Temperature resistance
- Pressure resistance
- Suitable material properties for the bath fluid used

6 Transport and installation

This section describes how to transport the unit safely.

6.1 Transporting the device

A circulator can be transported with the cooling machine when mounted.

	CAUTION
	<p>Risk of crushing by falling device!</p> <p>A device that is not secured appropriately can fall down during improper transport and cause crushing injuries.</p> <ul style="list-style-type: none"> • Secure the device against tipping and falling during transport • Secure loose parts against falling during transport • Transport the device upright and with a suitable means of transport • Wear personal protective equipment

	CAUTION
	<p>Burn hazard on the heating element!</p> <p>The heating element may still be hot even after the device has been switched off, and may cause burns if touched.</p> <ul style="list-style-type: none"> • Allow the device to cool down to room temperature after switching off • Wear protective gloves

- ▶ The device is switched off and emptied.
- ▶ A suitable transport trolley is available.
- 1. Unplug the power plug from the device.
- 2. If necessary, disassemble the temperature control hoses of the external system.
- 3. Use the recessed grips on the cooling machine to lift the device onto the center of the transport trolley, if necessary in a pair.
- 🔧 See the technical data for weight information.
- 4. Use straps to secure the device against tipping in the center of the transport trolley.
- 5. Place loose parts for the device, such as cables, on the transport trolley.
- ✓ The device is then ready for transport and can be safely transported to its installation location.

6.2 Install the device at the operating location

This section describes how the device is set up at the installation location.

- ▶ The device has been transported to the operation location.
- ▶ The size and infrastructure of the operation location are suitable for device operation.
- 1. If possible, position the device under an extraction system.
 - ⚠ Depending on the bath fluid, gases may be created at high temperatures.
 - ⚠ Recommended minimum distance of 1 m to other devices, to prevent electromagnetic interference.
- 2. Place the device on a level, smooth, non-flammable surface.
- 3. Ensure that the device is securely positioned.
- 4. For refrigerated circulators: Ensure an open space in front of and behind the device of at least 20 cm.
- ✓ The device is set up at the operation location.

7 Initial operation

7.1 Mounting the circulator

7.1.1 Mount heating or refrigerated circulator

In the case of a heating circulator or a refrigerated circulator, the circulator is mounted on the closed bath or on cooling machine.

If the circulator is disassembled, e.g. due to a change of device or for service purposes, it can then be easily reassembled with the connecting box.

✳ Allen key, size 3 mm

- ▶ The circulator is ready to be mounted on a closed bath or cooling machine.
- ▶ The bath is empty.

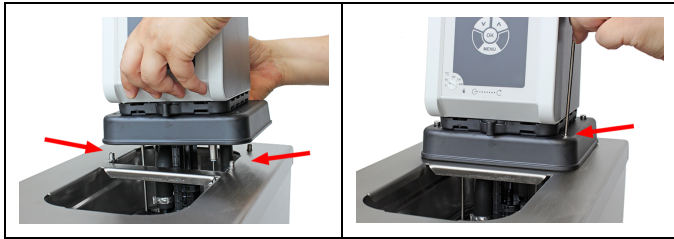

1. Carefully insert the circulator into the bath.
 - ↳ Align the bath's four threaded sleeves with the four holes on the connection box.
 2. Place the four mounting screws into the holes on the connection box.
 3. Tighten the mounting screws [right image].
 4. Check that the circulator is seated correctly, and that the connection box gasket is seated on the unit surface without any gaps.
- ✓ The heating circulator or refrigerated circulator is mounted.

7.2 Connect the device to the power supply

7.2.1 Connect bridge mounted or heating circulator

This section describes how the circulator is connected as a bridge mounted circulator or heating circulator.

- ▶ The circulator is mounted as a bridge mounted or heating circulator.
- ▶ The power cable is ready for use. If using the 200-230 V, 50/60 Hz variant in the United States or Canada, you must use the JULABO power cable USA 3x12AWG (order number 7.901.2694). This power cord is not included.



1. Insert the power cable on the back of the circulator into the mains connection [1].
 2. Connect the circulator to the power supply using the power cable.
- ✓ The circulator is connected.

7.2.2 Connect refrigerated circulator

This section describes how the circulator is connected as a refrigerated circulator.

- ▶ The circulator is mounted on a refrigeration unit.
- ▶ The connection cable, mains cable and CAN bus cable are ready for use.

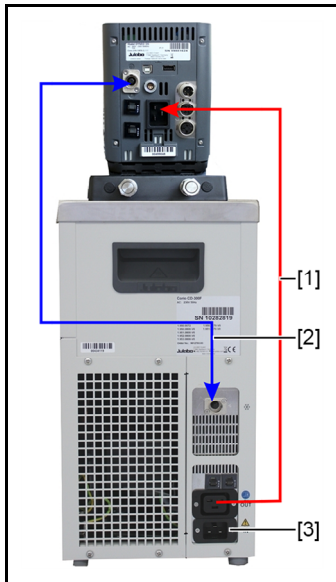

1. Connect the connection cable [1] of the circulator with the refrigeration unit.
 2. Connect the CAN plugs of both units with the CAN bus cable [2].
 3. Connect the refrigeration unit to mains power [3] using the power cable.
- ✓ The refrigerated circulator is connected. Alternatively, the units can be connected to separate circuits. If necessary, the power supply must be set up in the unit setting.

7.3 Connecting an external system

The device is designed for tempering external, closed loop systems. An external system is connected to the unit's pump connections.



CAUTION

Risk of burns due to damaged temperature control hoses!

Hot bath fluid can escape from damaged temperature control hoses and cause serious burns when it comes into contact with skin.

- Check the temperature control hoses regularly for integrity
- Immediately replace damaged temperature control hoses
- Do not kink temperature control hoses
- Regularly exchange temperature control hoses
- Check the pump connections for leak tightness



NOTE

Material damage due to incompatible externally connected system!

If the temperature range and/or pressure parameters of an externally connected system do not match those of the device this can result in damage to individual components or even failure of the entire system.

- Before connection check the external system for compatibility with the device combination
- If an external system is connected that is not set up for the maximum pressure of the device, the pump's flow rate must be limited in the settings
- If an external system is connected, the safety of the entire system is the responsibility of the operator





NOTE

Hot pump connections!

The pump connections can become very hot during operation. Heat-sensitive parts or cables can be damaged if they have contact.

- Pump connections must be uncovered during operation
- No loose parts or cables should come into contact with pump connections during operation

	NOTE
	<p>Overflowing bath fluid due to externally connected systems! If the externally connected system is higher than the temperature control system, bath fluid can flow back and overflow when switched off.</p> <ul style="list-style-type: none">• Position the connected external system on the same level or lower than the temperature control system• Position a shut-off valve or Solenoid valve between the external system and the temperature control system as backflow protection.

	NOTE
	<p>Damaged hoses due to kinking! Hoses are damaged by kinking and can may leak.</p> <ul style="list-style-type: none">• Lay hoses with large radii• Avoid kinking of the hoses

7.3.1 Connect an external system with screw connections

This section describes how to connect an external, closed system to the device using screw connectors.

- ✂ Open-end wrench, 17 mm
- ✂ Open-end wrench, 19 mm
- ✂ Torque wrench

- ▶ The circulator is equipped with the optional assembly frame or pump set.
- ▶ The temperature control hoses of the external system are equipped with M16x1 female and barrel gaskets.

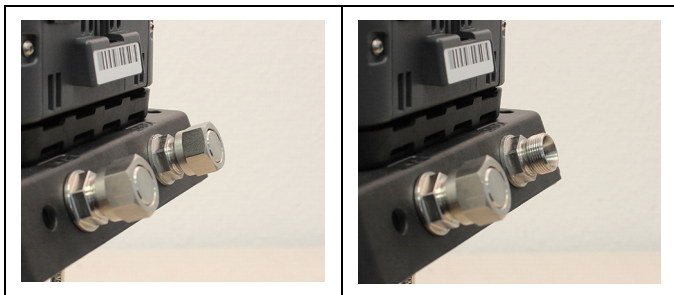

1. Remove the union nuts on the pump connections.

- Remove the sealing plugs.

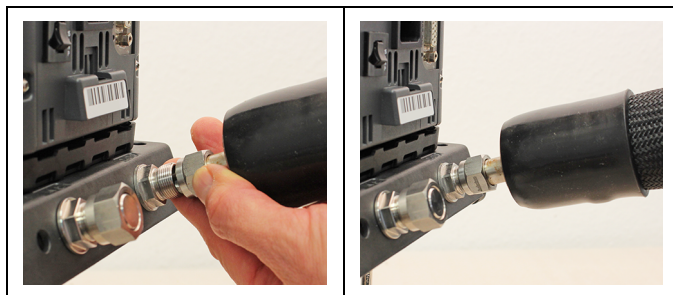

- Screw the hoses onto the pump connections by hand.
 - ☞ Pay attention to the supply and runback position.
- Carefully tighten the pump connections with a maximum torque of 3 Nm. Brace the nut (width across flats: 17 mm) using an open-end wrench.
 - ☞ **Warning!** Over-tightening the pump connections may cause the assembly frame to break.



- Set the flow direction lever to external circulation.
 - ✓ The external system is connected.
 - ☞ If the external system is disassembled, the pump connections must be resealed with the sealing plugs so that no bath fluid can splash out during operation.

7.3.2 Connect an external system with barbed fittings

This section describes how to connect an external, closed system to the device using barbed fittings.

- ✂ Open-end wrench, 17 mm
- ✂ Open-end wrench, 19 mm
- ✂ Torque wrench

- ▶ The circulator is equipped with the optional assembly frame or pump set.
- ▶ Barbed fittings are provided to install the external system.



1. Remove the union nuts on the pump connections.
2. Remove the sealing plugs.
3. Push one barbed fitting through each of the union nuts.
4. Mount the barbed fittings with the union nuts on the pump connections.
5. Carefully tighten the union nut with a maximum torque of 3 Nm. Brace the nut (width across flats: 17 mm) using an open-end wrench.
- ✂ **Warning!** Over-tightening the pump connections may cause the assembly frame to break.
6. Attach the external system's hoses to the barbed fittings.
- ✂ Pay attention to the supply and runback position.
7. Using tube clamps, secure the hose to prevent it from slipping.



8. Set the flow direction lever to external circulation.

- ✓ The external system is connected.
- ⚠ If the external system is disassembled, the pump connections must be resealed with the sealing plugs so that no bath fluid can splash out during operation.

7.4 Switch on the device and set the language

The language must be set first, to prepare for important basic settings. When switching on for the first time, alarm messages may be shown on the display.

- ▶ The device is connected and ready for operation.
- 1. Switch the device on at the mains switch.
- ↳ The software boots and starts the device. The display shows the device name, voltage version and software version.
- ↳ Since no temperature liquid has been filled yet, the low level alarm is displayed.
- ↳ Depending on the default setting, the high temperature cut-off alarm is displayed.
- 2. Call up the **<Main menu>**.
- 3. Call up the submenu **<Settings>** then menu option **<Language>**.
- ↳ The submenu **<Language>** lists all the languages installed on the device.
- 4. Select the desired language.
- 5. Turn the device off so that the alarm message is reset.
- ✓ The language is set.

7.5 Set high temperature safety function

Before each new temperature application, the temperature must be set for the tank and internal reservoir high temperature cut-off. Set a value that is at least 25 K below the flash point of the bath fluid being used. The surface temperature of the bath fluid must not exceed the flash point at any time. An alarm is triggered when the set value is exceeded.

✂ Slotted screwdriver, size 3

- ▶ The device is connected.
- ▶ The language is set.
- 1. Switch the device on.
- ↳ If no temperature liquid has been filled yet, the low liquid level alarm is displayed.
- ↳ Depending on the default setting, the high temperature cut-off alarm is displayed.

2. Press the **[Display]** softkey to select the home screen that displays the high temperature cut-off value.

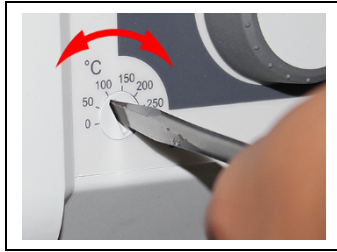

3. Use the screwdriver to set the overtemperature protection device.
 - ➔ The display shows the set value.
4. Set a value that is at least 25 K under the flash point of the bath fluid being used.
 - ➔ The set value is immediately active.
5. Turn the device off so that the alarm message is reset.
 - ✓ The high temperature cut-off is set.

7.6 Fill device

This section describes how the device should be filled with bath fluid during initial operation.

Specifications for filling volume can be found in the technical data.

- ▶ The drain valve is closed.
 - ▶ The unit is switched off.
1. Remove the bath lid.
 2. Half fill the bath with bath fluid.
 - ☞ The bath fluid expands with increasing temperature and can overflow.
 - ☞ With decreasing temperature, the low liquid level protection can be triggered and interrupt the temperature control process.
 3. Switch the unit on and start the temperature control application.
 - ☞ If an external system is connected, the pump supply must be set to "external" so that it fills the external system.
 4. Watch the level indicator and, if necessary, adjust the level by refilling or draining.
 - ☞ Once the working temperature has been reached and the sample inserted, the level of bath fluid in the bath tank should cover the heating coil of the heating circulator or the cooling coil of the cooling machine.
 5. Close the bath opening with the bath lid.
 - ✓ The unit is filled with bath fluid.

7.7 Set up power supply for the refrigerated circulator

For a refrigerated circulator, the power supply is configured at the factory. The circulator is supplied with power from the refrigeration unit. Alternatively, both units can be connected to separate circuits with one power cable each. The type of power supply is set in the operating menu.

- ▶ The cooling machine is connected.
 1. Switch the device on at the mains switch.
 2. Call up the **<Main menu>**.
 3. Call up the submenu **<Install unit>** then the menu option **<Power supply>**.
 3. Select the type of power supply: **[Supply via chiller]** for connection to the same power grid or **[Separate supply]** for connection to a different power grid.
- 🔗 **[Supply via chiller]** activates the heating capacity limit of the circulator. It prevents the device combination from exceeding a defined maximum current consumption and thus from overloading the power grid.
- ✓ The power supply for the refrigerated circulator is set up.

7.8 Adjusting the flow of the bath fluid

The flow direction of the bath fluid is set using the lever on the front control:

- Lever position left (external): The bath fluid is mainly fed into the external application.
- Lever position right (internal): The bath fluid is mainly circulated in the internal bath.



NOTE

Bath fluid squirts out!

If the pump connections are not sealed, bath fluid can squirt out even with the flow direction set to internal.

- For internal temperature control, close the external pump connections

- ▶ The device is switched off.
- ▶ Bath fluid is filled.



1. Set the lever to a low level for internal circulation (e.g. position 2 from the right stop).
 2. Switch on the device and check whether the flow of the bath fluid suits your application.
 3. If necessary, adjust the flow until it suits your application.
- ✓ The flow of the bath fluid is set.

7.9 Set chiller mode

For a refrigerated circulator, the chiller mode is preset ex works to automatic operation. Three different chiller modes can be selected in the operating menu:

- Automatic mode: The controller calculates the duration of the heating process in the event of a setpoint change of more than +5°K. Based on the calculated heating duration, the control decides whether the refrigeration unit is to be switched off or not, depending on demand.
- Always on: The refrigeration unit is permanently switched on during operation.
- Always off: The refrigeration unit remains switched off during operation.

- ▶ The device is switched on.
 - ▶ The cooling machine is connected.
1. Call up the **<Main menu>**.
 2. Call up the submenu **<Install unit>** then the menu option **<Chiller mode>**.
- ☞ The menu option can only be called up if the thermostat detects a connected refrigeration unit.
3. Select the desired chiller mode.
- ✓ The chiller mode is set.

7.10 Set limit values

7.10.1 Set temperature warning limits

The low temperature and high temperature are adjustable temperature limits that serve as warning limits for the device. If one of the warning limits is exceeded during the course of a tempering process, then the device warns with a signal tone and displays a warning message.

- ▶ The device is switched on.
- 1. Bring up the **<Main menu>**.
- 2. From the **<Adjust safety>** submenu, select the menu option **<Temperature limits>**.
- ➔ A window opens with input fields for the temperature warning limits.
- 3. Enter a value for low temperature and high temperature then confirm your entry.
- ⌚ Only values that are within the performance values of the device can be entered.
- ✓ The temperature warning limits are set.

7.10.2 Adjusting setpoint limits

The setpoint limits Setpoint max. and Setpoint min. define the upper and lower limit of the adjustable setpoint temperature range.

The setpoint limit for the pump defines the upper limit value for pump speed, adjustable in the menu **<Thermodynamics>**. The lower limit is set to 30% ex works.

The maximum pressure setpoint defines the upper limit value for the pump pressure that can be set in the menu **<Thermodynamics>**.

- ▶ The device is switched on.
- 1. Bring up the **<Main menu>**.
- 2. From the **<Adjust safety>** submenu, select the menu option **<Setpoint limits>**.
- ➔ The dialog window for adjusting the setpoint limits appears on the display.
- 3. Set the setpoints and confirm your entry.
- ⌚ Only values that are within the performance values of the device can be entered.
- ✓ The setpoint limits are set.

7.10.3 Adjusting actual value limits

The actual value limits “internal minimum” and “internal maximum” are effective in the external control operating mode. They define limits for the expected temperature in the internal bath. The temperature controller cannot exceed these limit values. Under certain circumstances, the external setpoint will not be reached.

- ▶ The device is switched on.
 1. Bring up the **<Main menu>**.
 2. From the **<Thermodynamics>** submenu, select the menu option **<Adjust controller>**.
- ↳ The dialog box for setting the controller appears on the display.
- 3. Switch to the submenu **<Limits>**.
- 4. Set the values for internal minimum and internal maximum in the dialog window displayed.
- ✓ The actual value limits are set and immediately active.

7.10.4 Band limit for external control

If an external system is being controlled then there is a temperature difference both during the heating phase and the cooling phase due to inertia. The curve illustrates the connection between the internal and external temperature sequence.

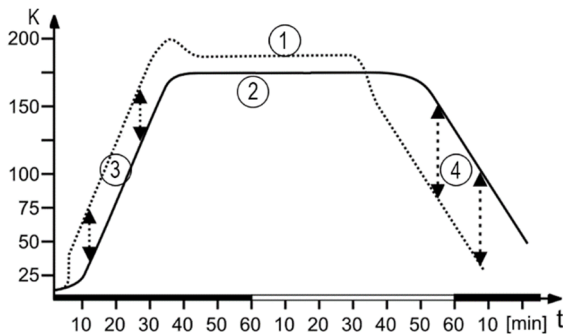

Schematic temperature sequence internal/external

- [1] Temperature sequence internal
- [2] Temperature sequence external system
- [3] Band limit upper
- [4] Band limit lower

In order to gently control the temperature of a sample in an external system, or to protect a glass reactor from thermal stress, for example, maximum permissible temperature differences can be specified for the heating phase and the cooling phase.

7.10.5 Setting band limit

The upper and lower band limit is defined in °K. In the heating phase the set value will be added to the external actual value. In the cooling phase the set value will be subtracted from the external actual value. The setting range is between 1 and 200 °K.

- ▶ The device is switched on.
- 1. Bring up the **<Main menu>**.
- 2. From the **<Thermodynamics>** submenu, select the menu option **<Adjust controller>**.
- ↳ The dialog box for setting the controller appears on the display.
- 3. Switch to the submenu **<Limits>**.
- 4. In the dialog box that appears, set the lower and upper band limits and confirm your entry.
- ✓ The band limits are set and immediately active.

7.11 Connect external temperature sensor

A Pt100 temperature sensor can be attached to the rear of the device.

- ▶ The device is switched off.
- ▶ A Pt100 temperature sensor with suitable connection is available.
- 1. Connect the Pt100 to the ext.Pt100 socket on the back of the device.
- 2. Switch the device on.
- 3. From the **<Thermodynamics>** submenu, select the menu option **<Adjust controller>**.
- 4. Enable the menu option **[External]** for external control.
- 5. Bring up the menu option **<Control behavior>**.
- 6. Set the control parameter for external control.
- ✓ The external temperature sensor is connected and ready for operation.

8 Operation

8.1 Switch on the unit

This section describes how to switch on the device.

- ▶ The unit is connected and ready for operation.
- 1. Switch the unit on at the mains switch.
- ↳ The software boots and starts the unit. The display shows the unit name, voltage version and software version.
- ✓ The unit is switched on. It switches to the most recently activated operating mode, manual mode of operation or remote control mode. If the auto start function is activated, then the unit starts directly into the last setting.
- ☞ If remote control mode is enabled, operation at the device is not possible. First, deactivate the remote control mode.

8.2 Switch off the unit

This section describes how to switch off the device.

- ▶ The device is switched on.
- 1. Stop a running temperature control application.
- ↳ If a cooling machine is connected, the cooling symbol flashes and the cooling machine is shut down.
- ☞ Do not switch off the device until the cooling symbol stops flashing and the device is in standby mode.
- 2. Switch the device off at the mains switch.
- ✓ The device is switched off.

8.3 Start temperature control application

A temperature application can be started directly on the unit. Other options include timer-controlled temperature control application with the integrated programmer and remote control via a connected PC.

- ▶ The unit is switched on.
- 1. Activate the **<Setpoint>** field on the Home screen with the central controller.
- 2. Enter the desired setpoint and confirm your input.

3. Press the **[Start/Stop]** softkey.
- ✓ The unit starts the temperature control application at once. The temperature control application can be stopped with the **[Start/Stop]** softkey. The entered setpoint is saved.
- 🔧 Observe the following for heating circulators:
For temperature control applications near or below the ambient temperature: Use a cooling coil or JULABO immersion cooler.

8.4 Basic settings

8.4.1 Set language

The language of the operating interface can be switched to one of the available languages.

- ▶ The device is switched on.
- 1. Call up the **<Main menu>**.
- 2. Call up the submenu **<Settings>** then menu option **<Language>**.
 - ➔ The submenu **<Language>** lists all the languages installed on the device.
- 3. Select the desired language.
- ✓ The selected language is immediately activated.

8.4.2 Set date and time

The date and time is preset ex works. This section describes how you can set the date and time yourself.

- ▶ The device is switched on.
- 1. Call up the **<Main menu>**.
- 2. Call up the submenu **<Settings>** then menu option **<Date/time>**.
 - ➔ The submenu shows the currently set date and time as well as selectable display formats.
- 3. Set the date and time and then confirm your settings.
- 4. Save the settings with the **[Save + Esc]** softkey.
- 5. Select one of the check boxes to display the date and time in a different format.
- ✓ The date and time are set.

8.4.3 Activate autostart function

The autostart function makes it possible to start a temperature control application directly using the mains switch or via an intermediate timer. The device is configured ex works in such a way that it switches to a safe operating status in the event of power failure. The autostart function is deactivated. The display shows "OFF." The refrigeration aggregate, heater, and pump motor are disconnected from the mains voltage.

- ▶ The device is switched on.
- 1. Bring up the **<Main menu>**.
- 2. From the **<Settings>** submenu, select the menu option **<Autostart>**.
- 3. Check the **<On>** box and confirm your setting.
- ✓ The autostart function is activated. The next time the device is switched on, the temperature control application will immediately start with the preset values. You can also connect and program a timer. In this case the mains switch must remain on.

8.4.4 Set physical units

The physical units for temperature, pressure and flow can be set in the menu.

- ▶ The device is switched on.
- 1. Bring up the **<Main menu>**.
- 2. From the **<Settings>** submenu, select the menu option **<Units>**.
- 3. Select the check boxes to display the desired units for temperature, pressure and flow.
- ✓ The physical units are set.

8.4.5 Set key tones

The device key tones can be enabled and disabled in the menu.

- ▶ The device is switched on.
- 1. Bring up the **<Main menu>**.
- 2. From the **<Settings>** submenu, select the menu option **<Key tones>**.
- 3. Enable or disable the key tones.
- ✓ The key tones are set. The setting is applied directly.

8.5 Record data

8.5.1 Record measurement data

Measurement data for an ongoing temperature control application can also be recorded onto a USB stick at the same time. The record documents the date, time, setpoint temperature, intern actual value, external actual value and the percentage power. The data is saved as a .txt file and can be subsequently analyzed.

- ▶ The device is switched on.
- ▶ A USB stick is available.
- 1. Bring up the **<Main menu>**.
- 2. Bring up the **<Record data>** submenu.
- ↳ The warning appears: "Please insert a USB stick!".
- 3. Insert the USB stick into the USB socket on the back of the device.
- 4. Bring up the **<Start measurement data recording on USB stick>** submenu.
- 5. Set the sampling interval from 1 to 60 seconds and confirm your setting.
- 6. Press the **[Start]** softkey.
- 7. If necessary, change the file name.
- 8. Confirm with the **[OK]** softkey.
- ✓ The measurement data recording is started. The data is recorded at the specified interval until you press the **[Stop recording]** softkey.

8.5.2 Reading out blackbox data

The blackbox stores all relevant data from the last 30 minutes. In addition, the black box logs alarms and warnings.

The blackbox can be read out and the data sent to technical service for analysis.

- ▶ The device is switched on.
- ▶ A USB stick is available.
- 1. Bring up the **<Main menu>**.
- 2. Bring up the **<Record data>** submenu.
- ↳ The warning appears: "Please insert a USB stick!".
- 3. Insert the USB stick into the USB socket on the back of the device.
- 4. Bring up the **<Save blackbox on USB stick>** submenu.
- 5. If necessary, change the displayed file name.
- 6. Confirm with the **[OK]** softkey.
- ✓ The blackbox data is saved onto the USB stick as a .txt file.

8.5.3 Displaying alarm memory

Alarm messages are stored with date, time, alarm code and unit identifier. The data can be read out via the menu.

- ▶ The device is switched on.
- 1. Bring up the **<Main menu>**.
- 2. From the **<Settings>** submenu, select the menu option **<Alarm memory>**.
- ↳ The device lists the stored alarm messages.
- 3. Press the **[Clear]** softkey to delete all entries.
- ✓ The alarm memory is displayed and cleared.

8.6 Thermodynamics

8.6.1 Control parameter

The device works with a PID control. Experience has shown that the control parameters set ex works achieve an optimal temperature sequence in the sample.

The internal and external control parameters can be adjusted in the submenu **<Control performance>**.

For internal control, the control dynamic can be set to either Standard or Aperiodic:

- With Aperiodic the temperature increase is temporally offset, so that the actual temperature doesn't overshoot
- With Standard the temperature increase is faster, but the actual temperature can overshoot by up to 5%

Proportional range Xp

The proportional range Xp is the temperature range between the setpoint value and the actual value, in which the heating capacity can be adjusted from 100% to 0%. The value for Xp can be selected between 0 K and 10 K.

Integral controller Tn

The integral controller Tn is indicated in seconds. It reduces the difference between the setpoint value and the actual value caused by the Xp component, and keeps to the setpoint value.

Differential controller Tv

The differential controller Tv is specified in seconds. It shortens the regulation time.

CoSpeed factor

The CoSpeed factor affects the temperature sequence when used with external control. It directly affects Xpu and causes more aggressive temperature control.

Proportional range Xpu

The proportional range Xpu plays a role in external control. It corresponds with the proportional range Xp for internal control.

8.6.2 Optimizing temperature curves

The temperature sequence shown on the display provides information about how individual control parameters can be optimized to achieve a better result.

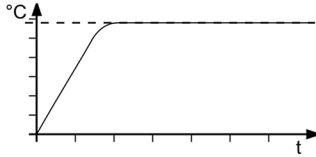

Optimal temperature sequence, temperature quickly reaches the setpoint without overshooting, and keeps the setpoint.

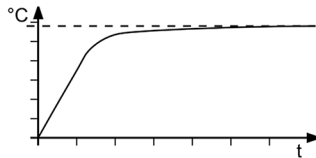

Symptom: Temperature sequence slowly approaches the setpoint and doesn't quite reach it.
Solution: Decrease T_v and/or T_n , increase X_p .

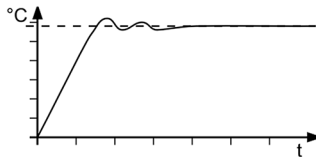

Symptom: Temperature sequence quickly approaches the setpoint, but overshoots it and oscillates.
Solution: Increase T_v and/or T_n .

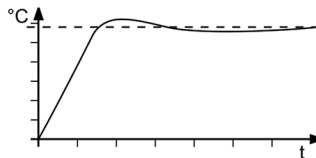

Symptom: Temperature sequence quickly approaches the setpoint and overshoots.
Solution: Increase X_p .

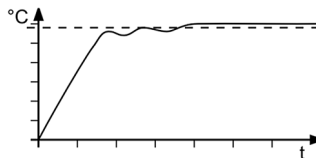

Symptom: Temperature sequence quickly approaches the setpoint, the temperature builds up and the setpoint is exceeded.
Solution: Decrease X_p and/or T_v .

8.6.3 Adjust controller

In the menu **<Adjust controller>** the individual control parameters for internal and external control can be set.

- ▶ The device is switched on.
- 1. Bring up the **<Main menu>**.
- 2. From the **<Thermodynamics>** submenu, select the menu option **<Adjust controller>**.
- ➔ The dialog box for setting the controller appears on the display.
- 3. Activate internal or external control.
- ☞ This results in the respective adjustable control parameters. External control is only possible with an externally connected Pt100 temperature sensor.
- 4. Switch to the submenu **<Control performance>**.
- 5. In the dialog box, set the desired parameters and confirm your entry.
- 6. For internal control: Activate the aperiodic temperature sequence or the standard temperature sequence.
- ✓ The control parameters are set and immediately active.

8.6.4 Limit cooling capacity and heating capacity

In the menu **<Limits>** the cooling capacity and heating capacity are limited.

- ▶ The device is switched on.
- 1. Bring up the **<Main menu>**.
- 2. From the **<Thermodynamics>** submenu, select the menu option **<Adjust controller>**.
- ➔ The dialog box for setting the controller appears on the display.
- 3. Switch to the submenu **<Limits>**.
- 4. In the dialog window that appears, set the limits for cooling capacity and heating capacity and confirm your entry.
- ✓ The values are set and are immediately active.

8.6.5 Adjust pump

In the submenu **<Adjust pump>** the working mode is set, as is the pump power in one percent increments.

- ▶ The unit is switched on.
- 1. Bring up the **<Main menu>**.
- 2. From the **<Thermodynamics>** submenu, select the menu option **<Adjust pump>**.
- 3. Enter the desired value for pump capacity in percent and confirm your input.

- ☞ The minimum value is defined internally. The maximum value is limited to the adjustable maximum pump power in the menu **<Setpoint limits>**.
- 4. Activate the desired pump mode.
- ✓ The pump is set.

To achieve low setpoint temperatures, it may be helpful to reduce the pump output in certain situations. This decreases the pump's heat input into the bath fluid.

8.7 Remote control device

The device can be connected to a PC via its interfaces and controlled remotely using a program such as ° EasyTemp. It is also possible to send interface commands to the device using a terminal.

The respective interface is set up when the remote control is deactivated. If remote control mode is enabled, the device cannot be operated directly.

8.7.1 Remote control device using USB interface

The device can be remote-controlled via the standard USB B interface.

- ▶ The device is switched off.
- ▶ The computer has a terminal program installed.
- 1. Connect the device (USB plug type B) to the computer with a commercially available USB cable.
- 2. Download the suitable USB driver from the download area of the website www.julabo.com.
- ☞ Depending on the operating system used by the connected computer, it may be necessary to install the USB driver.
- 3. Install the USB driver on the computer.
- 4. Switch the device on.
- 5. Call up the **<Main menu>** on the device.
- 6. In the submenu **<Connect unit>/<Remote control>** activate the USB interface.
- ➔ The home screen will show USB mode.
- 7. Start the terminal program on the computer.
- 8. Use the terminal program to select the COM port of the device and establish a connection.
- ✓ Remote control via the USB interface is activated. This is shown with the "USB" on the home screen. You can now remotely control the device with interface commands via the computer.

8.7.2 Set RS232 interface parameters

The interface parameters cannot be changed during remote control mode. If they differ from the factory settings, they must be set before remote control mode is activated.

- ▶ Remote control is deactivated.
- 1. Call up the **<Main menu>** on the unit.
- 2. From the submenu **<Connect unit>/<Digital interfaces>** call up the menu point **<RS232>**.
- 3. Set the interface parameters **[Baud rate]**, **[Handshake]** and **[Parity]** if they differ from the factory settings.
- ☞ If parity is "None," the number of data bits is set to 8.
- ✓ The interface parameters are set and immediately active.

8.7.3 Remote control device using RS232 interface

The device can be remote controlled via an optional RS232 interface. A null modem cable is required to connect to a PC.

- ▶ The device has an RS232 interface.
- ▶ The device is switched off.
- ▶ The computer has a terminal program installed.
- 1. Connect the device with the computer using a serial interface cable.
- 2. Switch the device on.
- 3. Start the terminal program on the computer.
- 4. Enter the interface parameters into the terminal program.
- ☞ For the default setting, see the RS232 interface section. The values can be set in the submenu **<Connect unit>/<Digital interfaces>/<RS232>**.
- 5. Use the terminal program to select the COM port of the circulators and establish a connection.
- 6. Call up the **<Main menu>** on the device.
- 7. Activate the RS232 interface in the **<Connect unit>/<Remote control>** submenu.
- ➔ The home screen will show RS232 mode.
- ✓ Remote control via the serial interface is activated. This is indicated by an "R" in the status bar of the home screen. R-OFF appears in standby mode. You can now remotely control the device with interface commands via the terminal program.

8.7.4 Set EPROG input

The EPROG input can be used to send an external voltage or current signal to the circulator. Depending on the setting, the circulator interprets the input signals as a setpoint temperature, power capacity, flow or pressure, and can output the values as a display on the start screen.

Please note the technical data of the REG/EPROG socket.

- ▶ The device is switched on.
 - ▶ The remote control mode is deactivated.
 - ▶ The external voltage or current source is connected via the REG/EPROG socket.
1. Bring up the **<Main menu>**.
 2. Bring up the **<Connect unit>** submenu.
 3. From the **<Analog interfaces>/<Analog module>** submenu, select the menu option **<EPROG>**.
 4. Select the input variable Setpoint, Capacity or Flow in the selection window.
 - ☞ If setpoint is selected then the external setpoint values must be set up.
 - ☞ If performance is selected then the actuating variable must be set up.
 5. Select the signal type voltage or current.
 6. Drive the external voltage/current source to the upper limit value.
 - ➡ The applied voltage or current will be shown as a measurement value.
 7. Enter the upper input value and confirm your input.
 8. Repeat steps 6 and 7 for the lower limit value.
 - ✓ The EPROG input is set.

8.7.5 Set external setpoint values

By default the setpoint is adjusted on the device or by the programmer. In addition to this, the device offers the ability to externally specify the setpoint using the analog REG/EPROG plug or an external Pt100 temperature sensor.

- ▶ The device is switched on.
 - ▶ The remote control mode is deactivated.
1. Call up the **<Main menu>**.
 2. Call up the submenu **<Connect unit>** then menu option **<External setpoint>**.
 3. Select Pt100 or EPROG.
 - ☞ Pt100 can only be selected if an external Pt100 temperature sensor is connected to the device. The setpoint is then set using the external temperature sensor.
 - ☞ EPROG can only be selected if the analog option is available and the setpoint is defined as the input variable in submenu **<Analog module>** for EPROG.
 - ✓ The external setpoint value is defined.

8.7.6 Set up actuating variable

If the device is in remote control mode then the variable (capacity) with which the cooling unit or heater is controlled can be set using interface commands. This section describes how the actuating variable can be set.

- ▶ The device is switched on.
- 1. Bring up the **<Main menu>**.
- 2. From the **<Connect unit>** submenu, select the menu option **<Actuating variable>**.
- 3. Select Digital or EPROG in the dialog window.
 - ⚡ Digital can only be selected if remote control mode is activated.
 - ⚡ EPROG can only be selected if the electronic slide-in module with analogue connections is available and the capacity has been defined as an input variable for EPROG in the submenu **<Analogue module>**. The remote control mode must be deactivated.
- ✓ The actuating variable is set.

8.7.7 Request device status

The current device status can be queried via an interface command.

- ▶ The device is connected to a PC via an interface.
- 1. Enter the command "status" in the terminal program and press **[Enter]**.
- ✓ The device responds with a status message. If an alarm or warning is pending, the device sends the respective alarm or warning message to the status query. Explanations of the status messages as well as alarm and warning messages can be found in the Appendix.

8.8 Working with the programmer

Temperature control profiles are defined temperature profiles with a setpoint temperature as well as a predefined temperature control duration or a predefined gradient.

The programmer calculates a temperature ramp from these programmed values. Use the profile timer function to start individual temperature control profiles and define the number of repetitions. Several temperature control profiles can be combined into one profile series.

In order for programmed temperature control profiles to run automatically, the device must remain switched on.

**NOTE****Falling bath fluid level!**

In the case of a prolonged temperature control application, the level of bath fluid in the bath tank can fall below the alarm limit due to evaporation. A low liquid level alarm is triggered and temperature control application stops.

- In the event of a prolonged temperature control application, regularly check the fill level of bath fluid in the bath tank
- If the level is low, refill the bath fluid

8.8.1 Setting the timer

The timer can be used to program the duration of a tempering from 0 to 999 minutes and to program the start time. The target temperature is set as the setpoint temperature.

After the set duration has elapsed, the device switches to the previously defined state:

- Standby mode
- Maintain target temperature
- Temper to original setpoint temperature

► The device is switched on.

1. Bring up the **<Main menu>**.

2. From the **<Programmer>** submenu, select the menu option **<Timer>**.

↳ The dialog box for setting the timer appears on the display.

3. Set the start time and the start date and confirm each entry.

4. Set the setpoint temperature and the desired duration, then confirm your entry.

5. In the **<Final state>** field, select how the device should behave after the temperature control expires.

6. Enable the **<Active>** field to activate the timer.

✓ The timer is programmed and active.

8.8.2 Creating and editing a temperature control profile

Eight individual temperature control profiles can be created with up to 60 individual steps each. The programmer processes the programmed steps of a temperature control profile according to the specifications.

► The device is switched on.

1. Bring up the **<Main menu>**.

2. From the **<Programmer>** submenu, select the menu option **<Edit profile>**.

3. Select one of the eight profiles and confirm your selection.
 - ↪ The selected profile changes to red.
4. Bring up the **<Edit>** submenu.
 - ↪ In the dialog window, the selected temperature control profile is displayed as an editable table with profile number, selected step, and total number of steps.
5. Press the **[Add]** softkey to add a new step.
 - ↪ The added step opens as an editable dialog window.
6. Set the setpoint temperature and the duration in hh/mm/ss format or the gradients in K/min format, and confirm your entry with **[OK]**.
 - ☞ If a gradient is specified, the time specifications are set to zero and vice versa, since both values are mutually dependent.
7. Press the **[Add]** softkey to add further steps at the end or the **[Insert]** softkey to insert them above the marked line.
8. Edit the values of the newly added steps and confirm each entry with **[OK]**.
9. When you have finished editing the temperature control profile, press the **[Back]** softkey to return to the **<Edit profile>** submenu.
 - ✓ The temperature control profile has been created and saved.

8.8.3 Delete temperature control profile

Existing temperature control profiles can be completely deleted. This deletes all saved profile data.

- ▶ The device is switched on.
 - ▶ Temperature control profiles are saved in the **<Programmer>** submenu.
1. Bring up the **<Main menu>**.
 2. From the **<Programmer>** submenu, select the menu option **<Edit profile>**.
 3. Select a temperature control profile and confirm your selection.
 - ↪ The selected temperature control profile changes to red.
 4. If you want to delete the selected temperature control profile, press the **[Delete]** softkey.
 5. Confirm the confirmation prompt with **[OK]** to delete the temperature control profile.
 - ↪ The temperature control profile will be deleted. A confirmation message appears, which must be confirmed with **[OK]**.
 - ✓ The temperature control profile has been deleted.

The **[Delete all profiles]** softkey can be used to delete all saved temperature control profiles at once. The procedure is the same as for deleting a single temperature profile.

8.8.4 Set profile timer

Temperature control sequences can be individually programmed for individual temperature control profiles in the **<Profile timer>** submenu.

- ▶ The device is switched on.
- 1. Bring up the **<Main menu>**.
- 2. From the **<Programmer>** submenu, select the menu option **<Profile timer>**.
 - ↳ The dialog box for setting the profile timer appears on the display.
- 3. Select the **<Profile>** field.
- ↳ The display changes to the **<Edit profile>** submenu.
- 4. Select a profile.
- 5. Press the **[Back]** softkey to return to the **<Profile timer>** submenu.
 - ↳ The selected temperature control profile is displayed in the dialog window.
- 6. Set the start time and the start date and confirm each entry.
- 7. In the **<Profile runs>** field, set how often the selected temperature control profile should be repeated.
- 8. In the **<Final state>** field, select how the device should behave after the temperature control sequence expires.
- 9. Enable the **<Active>** field to activate the profile timer.
- ✓ The profile timer is programmed and active.

8.8.5 Profile series setup

The sequence of a profile series is set up in the **<Profile series>** submenu. This defines the start time, the number of runs, the frequency, and the behavior of the device at the end of the profile series.

- ▶ The device is switched on.
- 1. Bring up the **<Main menu>**.
- 2. From the **<Programmer>** submenu, select the menu option **<Profile series>**.
 - ↳ The dialog box for setting the profile series appears on the display.
- 3. Select the **<Profile>** field.
- ↳ The display changes to the **<Edit profile>** submenu.
- 4. Select a profile.
- 5. Press the **[Back]** softkey to switch back to the **<Profile series>** submenu.
 - ↳ The selected temperature control profile is displayed in the dialog window.
- 6. Set the start time and date, as well as the series end and number of runs. Always confirm your entry.
- 7. In the **<Weekdays>** field, select the days on which the profile series should run.

8. In the **<Final state>** field, select how the device should behave after the profile series expires.
9. Enable the **<Active>** field to activate the profile series.
- ✓ The profile series is programmed and active. It starts at the programmed start time on the specified start date and runs through the specified number of temperature control applications on the specified weekdays. At the end of series production, the device switches to the defined final state.

8.9 Configure signal outputs

8.9.1 Configure signal outputs of the REG/EPROG plug

The REG/EPROG socket provides three channels as signal outputs. The voltage or current signals emitted via these channels can be externally processed.

The following values can be output:

- Setpoint: Specified setpoint
 - Internal: Internal temperature sensor value
 - External: External Pt100 temperature sensor value
 - Performance: Value of the variable
-
- ▶ The device is switched on.
 - ▶ The slide-in module with analog connections is installed.
1. Bring up the **<Main menu>**.
 2. Bring up the **<Connect unit>** submenu.
 3. From the **<Analog interfaces>/<Analog module>** submenu, select the menu option **<Channel 1...3>**.
 4. In the drop-down window, select the output variable Setpoint, Internal, External or Capacity.
 5. Enter the lowest output value as the 0 V value.
 6. Enter the highest output value as the 10 V value.
 7. Repeat steps 5 and 6 for channel 2 and channel 3 respectively.
 - ✎ Channel 3 configures the current output. 0 mA or 4 mA can be selected for the lowest output value.
 - ✓ The signal outputs of the REG/EPROG socket are configured.

8.10 Activating stand-by input

This section describes how standby input can be activated.

- ▶ The device is switched on.
- ▶ The electronics slide-in module with analog connections is installed.
- 1. Bring up the **<Main menu>**.
- 2. Bring up the **<Connect unit>** submenu.
- 3. From the **<Analog interfaces>/<Analog module>** submenu, select the menu option **<Standby>**.
- 4. Select Active in the selection window.
- ✓ The standby input is activated and can be used.

8.11 Adjusting the temperature sensor (ATC)

For physical reasons, there can be a temperature difference in the bath tank between the temperature sensor and a defined, more remote point within the bath fluid volume. As a result, the measured temperature deviates slightly from the actual bath temperature. Adjustment of the temperature sensor can increase accuracy of the temperature control application.

The adjustment of a temperature sensor requires the determination of the temperature difference between the temperature sensor and the reference thermometer. Three adjustment options are available:

- 1-point adjustment: When a sample is tempered to a certain setpoint. The adjustment curve is displaced parallel to the original curve by the reference amount.
- 2-point adjustment: When the temperature is controlled between two setpoints. The slope of the temperature curve is adjusted between two points.
- 3-point adjustment: When temperature is controlled within a temperature range. This results in an arched temperature curve.

8.11.1 Adjust internal temperature sensor

This section describes how to adjust the internal temperature sensor of the device.

- ▶ The bath tank is filled.
- ▶ The unit is switched on.
- ▶ A calibrated reference thermometer is available.
- 1. Hang the calibrated thermometer in the bath.
- 2. Bring up the **<Main menu>**.

3. From the **<Install unit>** submenu, select the menu option **<Adjust sensor>**.
4. Set the internal mode to inactive.
 - ↳ The input fields are unlocked.
5. Enter the desired setpoint for internal in the first line and confirm your entry.
6. Enable the number field highlighted in blue on the first line.
 - ↳ The temperature control application starts. Let the reference thermometer settle for 10 minutes.
7. Enter the measured reference value in the first line in the Cal. column.
8. If necessary, repeat steps 5 to 7 for a 2-point or 3-point adjustment.
9. Activate the mode for the desired number of measuring points and press the **[Save]** softkey.
 - 🔑 The stored correction values are active immediately.
 - ✓ The internal temperature sensor is adjusted.

8.11.2 Adjust external temperature sensor

Measurable temperature differences can also occur in a connected application. As with the internal temperature sensor, adjustment of the external temperature sensor can improve accuracy of the temperature control application.

- ▶ The unit is switched on.
 - ▶ External control is active.
 - ▶ An external temperature sensor is connected.
 - ▶ The bath tank is at least two thirds full.
 - ▶ A calibrated reference thermometer is available.
1. Hang the reference thermometer in the connected external bath tank.
 2. Bring up the **<Main menu>**.
 3. From the **<Install unit>** submenu, select the menu option **<Adjust sensor>**.
 4. Set the mode for external to inactive.
 - ↳ The input fields are unlocked.
 5. For external, enter the desired setpoint in the first line and confirm your entry.
 6. Enable the number field highlighted in blue on the first line.
 - ↳ The temperature control application starts. Let the reference thermometer settle for 10 minutes.
 7. Enter the measured reference value in the first line in the Cal. column.
 8. If necessary, repeat steps 5 to 7 for a 2-point or 3-point adjustment.
 9. Activate the mode for the desired number of measuring points and press the **[Save]** softkey.
 - 🔑 The stored correction values are active immediately.
 - ✓ The external temperature sensor is adjusted.

8.12 Device Reset

The function resets the device to the factory settings.

- ▶ The device is switched on.
 - 1. Bring up the **<Main menu>**.
 - 2. Call up the **<Reset device>** menu item in the **<Install device>** submenu.
 - 3. If you want to reset the device, confirm the security prompt with **[OK]**.
- ✓ The device is reset to factory settings.

9 Maintenance

9.1 Replace detachable power cord

The device is equipped with a detachable power cord.

If the power cord needs to be replaced, ensure that the new one is at least dimensioned for the device power requirements. Insufficiently dimensioned power cords must not be used. See type plate for mains voltage and current value.

We recommend only using original JULABO spare parts.

9.2 Check safety symbols

The safety labels affixed to the device must be clearly legible at all times. Their condition must be checked every two years.

1. Check the safety signs on the device for legibility and completeness.
2. Replace defective or missing safety markings.
 - ✎ Safety signs can be reordered from JULABO.
 - ✓ The safety signs on the device have been checked.

9.3 Check the functionality of high temperature cut-off

This section describes how you can test that the high temperature safety function is operational.

✂ Slotted screwdriver, size 3

- ▶ The device is switched on.
1. Set the display of the start screen so that it shows the high temperature cut-off value.
2. Use the screwdriver to adjust the overtemperature protection to a temperature that is below the displayed actual value.
 - ➔ An acoustic signal sounds and the alarm message "Set protective temperature exceeded" is displayed. The high temperature cut-off works.
3. Then set a value that is above the actual value.
4. Switch the device off, wait a few seconds, then switch the device on again.
 - ➔ The alarm message is deactivated.
5. Set the high temperature cut-off.
 - ✓ The high temperature cut-off is set and its functionality tested.

9.4 Test the low liquid level safety function

This section describes how you can test that the low liquid level safety function is operational.

- ▶ The device is switched on.
 1. Remove the bath lid.
 2. Using a long object, e.g. a straightedge, carefully push the thermostat float downwards until it reaches its mechanical stop.
 - ↪ A beep sounds and the "Tempering fluid level too low" alarm message is displayed. The low liquid level safety function works.
 3. Switch the device off, wait a few seconds, then switch the device on again.
 - ↪ The alarm message is deactivated.
 4. Close the bath opening.
- ✓ The low liquid level safety function has been tested for functionality.

9.5 Emptying

The device must be completely drained if it is to be sent in for technical service or is to be properly disposed of.

In general, the device should be completely emptied before longer shutdowns or when there is a change to the external application.

	CAUTION
	<p>Risk of burns from hot bath fluid!</p> <p>Bath fluid can become very hot during a temperature control process. Contact with hot bath fluid can cause scalding.</p> <ul style="list-style-type: none"> • Before draining the device, let it cool to room temperature • Avoid direct contact with hot bath fluid • Wear protective gloves

- ▶ The device is tempered to room temperature and switched off.
 1. Place an adequately large collection vessel under the drainage valve.
 2. Take off the bath lid.
 3. Open the drain valve.
 - ↪ The bath fluid drains out of the bath tank into the collection vessel provided.
 4. Once the bath tank is completely drained, close the bath opening.
 5. Close the drain valve.
- ✓ The device is emptied. If an external system is connected, it can now be disconnected from the device and also drained.

9.6 Clean device

The circulator and bath tank, and also a cooling machine if connected, should be cleaned from time to time.

In addition to this, the device must be appropriately decontaminated if hazardous substances have been spilled on or into the device.

- ✘ Lint-free cloth
- ✘ Mild cleaning agent



NOTE

Damage to the electronics due to water penetration!

Ingress of water can damage electronic components of the device and thus lead to failure of the device.

- Clean the outside of the device with a damp cloth only
- Prevent water from entering the device

- ▶ The device is switched off and disconnected from the mains voltage.
 1. Allow the device to cool down to room temperature.
 2. Completely drain the bath fluid.
 3. Clean the surface of the bath tank and the circulator with a damp cloth.
 - ☞ Some dish detergent may also be used for cleaning. If in doubt, ask technical service for alternative cleaning mediums.
 4. Take the venting grid off the cooling machine.
 5. Carefully vacuum the dirt off the condenser.
 - ☞ Make sure that the fins of the condenser are not damaged.
 6. Place the venting grid back on.
- ✓ The device has now been cleaned.

9.7 Device storage

This section describes how to store the device.

- ▶ The device is switched off and disconnected from the mains voltage.
 1. Empty all system components completely.
 2. Clean the device.
 3. Carefully dry the device and all its system components, e.g. with compressed air.
 4. Close all connections.
 5. Store the device in a dust-free, dry and frost-free location.
- ✓ The device is protected and can be safely stored there. It can be put into operation again as needed.

9.8 Technical Service

If the unit shows faults you cannot resolve, please contact our Technical Service.

JULABO GmbH
Technical Service
Gerhard-Juchheim-Strasse 1
77960 Seelbach / Germany
Tel.: +49 7823 51-66
Fax: +49 7823 51-99
Service.de@julabo.com

Before sending a device to Technical Service, the following points must be observed:

- Clean and decontaminate the device properly to avoid endangering service personnel.
- Include a brief description of the fault.
- Package the device safely for shipment.

9.9 Warranty

JULABO provides a warranty that the device will function perfectly as long as it is connected and used correctly and as described in the operating manual.

The warranty period is one year from the invoice date.

2 Years Warranty
1Plus Warranty
Registration free of charge on www.julabo.com

With the 1PLUS warranty, the warranty can be extended to two years free of charge.

The 1PLUS warranty gives the user a free extended warranty to 24 months, limit to a maximum of 10,000 hours of service.

A prerequisite for this is that the user registers the device at **www.julabo.com**, quoting its serial number, within four weeks of initial operation. The warranty applies from the date of JULABO GmbH's original invoice.

10 Disposal

10.1 Device disposal

When disposing of the device, the applicable country-specific guidelines must be observed.

- ▶ The circulator combination is switched off and disconnected from the mains voltage.
 1. Empty the bath tank or cooling machine completely.
 2. Disconnect all power cables and, if necessary, data cables from the circulator and from other connected devices.
 3. If present, disconnect the circulator combination from a connected external application.
 4. Remove the circulator from the bath tank or cooling machine.
 5. Give the devices to an authorized disposal company.
- ✎ Disposed of the device in household waste, or similar facilities for the collection of domestic waste, is not permissible.
- ✓ The circulator combination is disposed of properly.

11 EC Declaration of Conformity

EG-Konformitätserklärung nach EG Maschinenrichtlinie 2006/42/EG, Anhang II A EC-Declaration of Conformity to EC Machinery Directive 2006/42/EC, Annex II A

Hersteller / Manufacturer:

JULABO GmbH
Gerhard-Juchheim-Strasse 1
77960 Seelbach / Germany
Tel: +49 7823 51-0



Hiermit erklären wir, dass das nachfolgend bezeichnete Produkt
We hereby declare, that the following product

Produkt / Product: Thermostat / Circulator

Typ / Type: DYNEO DD

Serien-Nr. / Serial-No.: siehe Typenschild / see type label

aufgrund seiner Konzipierung und Bauart in der von uns in Verkehr gebrachten Ausführung den grundlegenden Sicherheits- und Gesundheitsanforderungen der nachfolgend aufgeführten EG-Richtlinien entspricht.
due to the design and construction, as assembled and marketed by our Company – complies with fundamental safety and health requirements according to the following EC-Directives.

Maschinenrichtlinie 2006/42/EG; Machinery Directive 2006/42/EC
EMV-Richtlinie 2014/30/EU; EMC-Directive 2014/30/EU
RoHS-Richtlinie 2011/65/EU; RoHS-Directive 2011/65/EU

Angewandte harmonisierte Normen und techn. Spezifikationen:
Applied following harmonized standards and technical specifications:

EN IEC 63000:2018

Technische Dokumentation zur Beurteilung von Elektro- und Elektronikgeräten hinsichtlich der Beschränkung gefährlicher Stoffe
Technical documentation for the assessment of electrical and electronic products with respect to the restriction of hazardous substances

EN ISO 12100 : 2010

Sicherheit von Maschinen - Allgemeine Gestaltungsleitsätze - Risikobeurteilung und Risikominderung (ISO 12100:2010)
Safety of machinery - General principles for design - Risk assessment and risk reduction (ISO 12100:2010)

EN 61010-1 : 2010 / A1 : 2019 / AC : 2019-04, EN 61010-1 : 2010 / A1:2019

Sicherheitsbestimmungen für elektrische Mess-, Steuer-, Regel- und Laborgeräte, Teil 1: Allgemeine Anforderungen
Safety requirements for electrical equipment for measurement, control, and laboratory use, Part 1: General requirements

EN IEC 61010-2-010:2020

Sicherheitsbestimmungen für elektrische Mess-, Steuer-, Regel- und Laborgeräte Teil 2-010: Besondere Anforderungen an Laborgeräte für das Erhitzen von Stoffen
Safety requirements for electrical equipment for measurement, control, and laboratory use, Part 2-010: Particular requirements for laboratory equipment for the heating of materials

EN 61326-1 : 2013

Elektrische Mess-, Steuer-, Regel- und Laborgeräte- EMV-Anforderungen- Teil 1: Allgemeine Anforderungen
Electrical equipment for measurement, control, and laboratory use - EMC requirements - Part 1: General requirements

Bevollmächtigter für die Zusammenstellung der technischen Unterlagen:

Authorized representative in charge of administering technical documentation:

HR. Torsten Kauschke, im Haus / on the manufacturer's premises as defined above

Die Konformitätserklärung wurde ausgestellt

The declaration of conformity was issued and valid of

Seelbach, 16.05.2023

i.V. Bernd Rother, Senior Expert Products & Innovation

12 UK Declaration of Conformity

UK Office: JULABO UK Ltd., Unit 7, Casterton Road Business Park,
Old Great North Road, Little Casterton, Stamford, PE9 4EJ, United Kingdom,
Tel.: +44 1733 265892

UKCA-Declaration of Conformity

Manufacturer:

JULABO GmbH
Gerhard-Juchheim-Strasse 1
77960 Seelbach / Germany
Tel: +49 7823 51-0



This declaration is issued under the sole responsibility of the product manufacturer

Product: Circulator

Type: DYNEO DD

Serial-No.: see type label

The object of the declaration described above is in conformity with the relevant UK Statutory Instruments and their amendments:

Supply of Machinery (Safety) Regulations 2008
Electromagnetic Compatibility Regulations 2016
The Restriction of the Use of Certain Hazardous Substances in Electrical and Electronic Equipment Regulations 2012

Applied following harmonized standards and technical specifications:

EN IEC 63000:2018

Technical documentation for the assessment of electrical and electronic products with respect to the restriction of hazardous substances

EN ISO 12100 : 2010

Safety of machinery - General principles for design - Risk assessment and risk reduction (ISO 12100:2010)

EN 61010-1 : 2010 / A1 : 2019 / AC : 2019-04, EN 61010-1 : 2010 / A1:2019

Safety requirements for electrical equipment for measurement, control, and laboratory use, Part 1: General requirements

EN IEC 61010-2-010:2020

Safety requirements for electrical equipment for measurement, control, and laboratory use, Part 2-010: Particular requirements for laboratory equipment for the heating of materials

EN 61326-1 : 2013

Electrical equipment for measurement, control, and laboratory use - EMC requirements - Part 1: General requirements

Authorized representative in charge of administering technical documentation:

JULABO UK Ltd., Mr. Gary Etherington, Unit 7, Casterton Road Business Park, Little Casterton, Stamford PE9 4EJ
United Kingdom, Telephone: +44 1733 265892

The declaration of conformity was issued and valid of

Seelbach, 16.05.2023

i.V. Bernd Rother, Senior Expert Products & Innovation

13 Appendix

13.1 Interface commands

Interface commands allow the device to be remote controlled. Parameters can be retrieved and the current status can be queried. To do this, the device must be connected to the master computer via a digital interface. Interface commands are entered using a terminal program.

Interface commands are divided into IN commands and OUT commands.

- IN commands: Retrieve parameters
Command structure: Command + ↵

E.g. Retrieve the setpoint temperature:
IN_SP_00↵

E.g. Response of the device:
55.5 ↵LF

- OUT commands: Set parameters (only in remote control mode)
Command structure: Command + _ + Parameter ↵

E.g. Set the setpoint temperature to 55.5 °C:
OUT_SP_00_55.5↵

13.1.1 IN commands

IN commands retrieve device parameters.

Process values	System response
in_pv_00	Actual value
in_pv_01	Current variable (%)
In_pv_02	Current temperature of the external Pt100 temperature sensor
in_pv_03	Current temperature of the temperature safety sensor
in_pv_04	Current setting of the high temperature safety function
in_pv_06	Current pressure. EPROG input must be set to pressure
in_pv_07	Current flow. EPROG input must be set to flow
in_pv_16	Current bath fluid filling level (%)

Setpoints and warning limits	System response
in_sp_00	Set setpoint temperature
in_sp_03	Set high temperature warning limit
in_sp_04	Set low temperature warning limit
in_sp_05	Set working temperature via EPROG
in_sp_06	Setpoint temperature set via watchdog function
in_sp_07	Set pump stage (1 ... 4)
in_sp_10	Set actuating variable specification via serial interface
in_sp_11	Set temperature unit 0 = °C 1 = °F
in_sp_12	Set pressure unit: 0 = bar 1 = psi
in_sp_13	Set flow unit: 0 = l/min 1 = gpm
in_sp_27	Set pump setting
in_sp_28	High temperature alarm limit
in_sp_29	Low temperature alarm limit

Device modes	System response
in_mode_01	Return value 0. The value 0 stands for the control temperature setpoint as only one temperature setpoint can be set (downward compatibility for older devices)
in_mode_03	Operating mode setting for the EPROG input: 0 = 0...10 V 1 = 4...20 mA
in_mode_04	Operating mode setting for the temperature control: 0 = Internal 1 = External
in_mode_05	Operating mode set for the temperature control system: 0 = Stop 1 = Start

in_mode_08	Controller dynamics set with internal temperature control: 0 = Aperiodic 1 = Standard
in_mode_11	Actuating variable source: 0 = Circulator 1 = Serial 2 = Analog (EPROG)

IN PAR	System response
in_par_00	Set sensor difference between working temperature sensor and safety temperature sensor
in_par_01	Set time constant of the external bath TE
in_par_02	Set internal gradient value SI
in_par_03	Set time constant of the internal bath TI
in_par_04	Set optimization parameter CoSpeed
in_par_05	Ration of cooling/heating capacity pk to ph
in_par_06	Set control parameter Xp of the internal controller
in_par_07	Set control parameter Tn of the internal controller
in_par_08	Set control parameter Tv of the internal controller
in_par_09	Set control parameter Xp of the cascade-controller
in_par_10	Set control parameter Xpu of the subordinate controller (cascade temperature control)
in_par_11	Set control parameter Tn of the cascade-controller
in_par_12	Set control parameter Tv of the cascade-controller
in_par_13	Set maximum permissible internal temperature InternMax in cascade temperature control
in_par_14	Set minimum permissible internal temperature InternMin for cascade temperature control
in_par_15	Set band limit upper in cascade temperature control
in_par_16	Set band limit lower in cascade temperature control

Auxiliary parameters	System response
in_hil_00	Set actuating variable limit for cooling capacity (%)
in_hil_01	Set actuating variable limit for heating capacity (%)

13.1.2 OUT commands

OUT commands set device parameters. Remote control mode must be active.

Parameter settings	Parameter	Setting
out_sp_00	xxx.xx	Setting for the setpoint temperature
out_sp_03	xxx.xx	Setting for the high temperature
out_sp_04	xxx.xx	Setting for the low temperature
out_sp_06	xxx.xx	Setpoint temperature setting via watchdog function
out_sp_07*	x	Set pump to preset levels 1...5
out_sp_10	xxx.xx	Setting for the actuating variable via the serial interface
out_sp_11	x	Setting the temperature units: 0 = °C 1 = °F
out_sp_27	xxx	Pump capacity in %
out_sp_28	xxx.xx	High temperature alarm limit setting
out_sp_29	xxx.xx	Low temperature alarm limit setting

* Do not use for reprogramming, use out_sp_27 instead. Pump stage 4 has an output pressure of approx. 450 mbar.

Device modes	Parameter	Setting
out_mode_01	x	Setting 0 (for reasons of downwards compatibility the parameters 1 or 2 can also be used. Within the device it has no effect)
out_mode_03	x	Setting of the operating mode EPROG: 0 = 0-10 V 1 = 0-20 mA
out_mode_04	x	Setting of the temperature control: 0 = Internal control 1 = External control
out_mode_05	x	Start/stop command of the device in remote control mode: 0 = Stop tempering 1 = Start tempering

out_mode_08	x	Setting of the internal control dynamic: 0 = Aperiodic 1 = Standard
out_mode_11	x	Actuating variable source: 0 = Thermostat 1 = Serial 2 = Analog (EPROG)

System parameter	Parameter	Setting
out_par_04	xxx	Setting the Cospeed control parameter for internal control
out_par_06	xxx	Setting of the control parameter XP for internal control
out_par_07	xxx	Setting of the control parameter TN for internal control
out_par_08	xxx	Setting of the control parameter TV for internal control
out_par_09	xxx	Setting of the control parameter XP of the subordinate controller (cascade temperature control)
out_par_10	xxx	Setting of the control parameter XPU of the subordinate controller (cascade temperature control)
out_par_11	xxx	Setting of the control parameter TN of the subordinate controller (cascade temperature control)
out_par_12	xxx	Setting of the control parameter TV of the subordinate controller (cascade temperature control)
out_par_13	xxx	Setting of the maximum permissible internal temperature InternMax in cascade temperature control
out_par_14	xxx	Setting of the minimum required temperature InternMin in cascade temperature control
out_par_15	xxx	Setting of the band limit upper in cascade temperature control
out_par_16	xxx	Setting of the band limit lower in cascade temperature control

Auxiliary parameters	Parameter	Setting
out_hil_00	-xxx	Setting of the actuating variable limit for cooling capacity (0-100%)
out_hil_01	xxx	Setting of the actuating variable limit for heating capacity (0-100%)

13.1.3 Status commands

Status commands are used to query the current status of the device.

Status commands	System response
version	Current firmware version
status	Return of status, error, warning, alarm

13.1.4 Status messages

Possible status messages from the device for a status query.

Status message	Explanation
00 MANUAL STOP	Device in standby mode manual operation
01 MANUAL START	Device in manual mode
02 REMOTE STOP	Device in standby mode, remote control operation
03 REMOTE START	Device in remote control mode
-08 INVALID COMMAND	Device did not recognize the last received command
-09 COMMAND NOT ALLOWED IN CURRENT OPERATING MODE	Last received command is not permissible in the operating mode
-10 VALUE TOO SMALL	The last set value is too small
-11 VALUE TOO LARGE	The last set value is too large
-13 VALUE EXCEEDS TEMPERATURE LIMITS	The value is not within the set temperature limits

13.2 Alarms and Warnings

If the device is connected to a network and remotely controlled, a status query via interface command will output any pending alarms or warnings as text. Alarm and warning messages are described in the table.

If a displayed error code is not described in the table or the error is still pending after switching off and on again, please contact Technical Service.

The listed error codes can occur depending on the device type and version.

-01	The unit is being operated with a bath fluid level that is too low.	<ul style="list-style-type: none"> • Top up the bath fluid. • Check the temperature control hoses for damage and replace if necessary.
-03	The measured temperature is over the set high temperature limit.	<ul style="list-style-type: none"> • Increase "high temperature" temperature limit or decrease temperature setpoint.
-04	The measured temperature is below the set low temperature limit.	<ul style="list-style-type: none"> • Reduce "low temperature" temperature limit or increase temperature setpoint.
-05	The cable for the working temperature sensor has broken or short-circuited.	<ul style="list-style-type: none"> • Contact Technical Service.
-06	The temperature difference between the working temperature sensor and the safety temperature sensor is too large.	<ul style="list-style-type: none"> • Increase circulation. • Check the viscosity of the tempering fluid. • If the fault has not been remedied, contact Technical Service.
-14	The set protective temperature has been exceeded.	<ul style="list-style-type: none"> • Check working temperature range of the application. • Increase the value of the protective temperature or decrease the setpoint temperature until it is lower than the set protective temperature.
-15	The line of the external temperature sensor has short circuited or been interrupted.	<ul style="list-style-type: none"> • Check electrical connection to external temperature sensor.

-38	The setpoint value is set to external temperature sensor, but no signal is available.	<ul style="list-style-type: none">• Check whether an external temperature sensor is connected or whether the electrical connection is interrupted.• If necessary, adjust the setpoint value.
-40	The early warning system for low liquid level reports a critical fluid level.	<ul style="list-style-type: none">• Top up the bath fluid.
-60	Internal read/write error.	<ul style="list-style-type: none">• Switch off the unit at the mains switch, wait 4 seconds and then switch the unit on again.
-61	CAN bus error	<ul style="list-style-type: none">• Check CAN bus cable for damage and replace as necessary. Switch the unit on again. If the fault has not been remedied, contact Technical Service.• Alternatively: Deactivate the refrigeration unit. The circulator operates as a heater thermostat.
-62	CAN bus error	<ul style="list-style-type: none">• Switch off unit at mains switch, wait 4 seconds, then switch on unit again.
-63	Watchdog function has responded.	<ul style="list-style-type: none">• Switch off the unit at the mains switch, wait 4 seconds and then switch the unit on again.
-70	Units with incompatible voltage/frequency variants connected to each other or units incorrectly configured.	<ul style="list-style-type: none">• Check the permissible operating voltage of the units and their configuration.
-72	Configuration between circulator and connected refrigeration unit failed.	<ul style="list-style-type: none">• Switch off the unit at the mains switch, wait 4 seconds and then switch the unit on again.
-83	Excessive power consumption via USB interface.	<ul style="list-style-type: none">• Check inserted USB stick for defects and replace as necessary. The USB-A interface is not suitable for consumers with a higher required current than the maximum permissible current.
-108	The alarm latch of the protective equipment is still active.	<ul style="list-style-type: none">• Switch off the unit at the mains switch, wait 4 seconds and then switch the unit on again.

-116	The alarm latch of the protective equipment is still active.	<ul style="list-style-type: none">• Switch off the unit at the mains switch, wait 4 seconds and then switch the unit on again.
-427	Pressure sensor detects excessive condensation pressure.	<ul style="list-style-type: none">• Check ambient temperature and reduce if necessary.• Check condenser for soiling and clean as necessary.• Switch off the unit at the mains switch, wait 4 seconds and then switch the unit on again.• For water-cooled units: Check cooling water temperature and supply.• If the fault has not been remedied, contact Technical Service.
-431	The maximum permissible current consumption at the compressor has been exceeded.	<ul style="list-style-type: none">• Check mains voltage for nominal voltage.• If the fault has not been remedied, contact Technical Service.
-1109	Viscosity of the bath fluid too high or the circulation rate too low.	<ul style="list-style-type: none">• Check the temperature of the bath fluid to ensure it is within the desired temperature range.
-1427	Pressure sensor detects excessive compensation pressure.	<ul style="list-style-type: none">• Check ambient temperature and reduce if necessary.• Check condenser for soiling and clean as necessary.• Switch off the unit at the mains switch, wait 4 seconds and then switch the unit on again.• For water-cooled units: Check cooling water temperature and supply.• If the fault has not been remedied, contact Technical Service.

-1431	The minimum permissible current consumption at the compressor has been fallen short of.	<ul style="list-style-type: none"> • Check mains voltage for nominal voltage. The specified voltage tolerance of the unit must not be exceeded. • Check the mains cable of the refrigeration unit for damage and replace if necessary. • Check ambient temperature and reduce if necessary. • Check CAN bus cable for damage and replace as necessary. • If the fault has not been remedied, contact Technical Service.
-2426	Evaporation temperature has fallen below the warning threshold.	<ul style="list-style-type: none"> • Check pump setting • Check hose cross-section of connection to application • Check that connection to application is clear • Check suitability of bath fluid

