

THE *Clifton* RANGE

**Stirred Digital Baths NE4-D and NE4-D/CT Series
Circulator Digital Baths NE4-P and NE4-HT Series**

This series of water baths features a low liquid level float switch. If the liquid drops below the recommended level heating and stirring is automatically switched OFF and a "FILL" message appears on display - top up liquid level for heating and stirring to resume.

IMPORTANT: ALWAYS FILL the water bath before connecting to the power supply.

CONTENTS

About this Manual	3
General Notes	3
Amendments	3
Symbols	3
Location	4
Unpacking	4
Safety	4
Power Supply Lead and Connection to Electrical Supply	4
Assembly NE4-D/CT models	5
Front and Rear Views - NE4D and NE4-D/CT	6
Front and Rear Views - NE4P and NE4-HT	7
Liquid Level	8
Suitable Liquids	8
NE4-P and NE4-HT Series Connecting Circulated Supply	8
Operating Instructions	9
- Switching On and Off	9
- Heating Control Modes	9
Control Panel	9
-Keyboard Description	9
- LED Indicators	9
Operating Instructions	10
- Setting Temperature	10
- Setting Time	10
- Timer Operation	10
Power Interrupt	11
Explanation of Temperature Control Terms	11
Under and Over-temperature Alarms	12
Safety experiment protector	12
Low Liquid level Float switch - all models - "FiLL" message	12
Periodical check	12
General Cleaning	13
Cleaning external painted surfaces with Anti-bacterial finish	13
Cleaning the stainless steel tank	13
Descaling the stainless steel tank	14
Decontamination of Equipment	14
Virucidal Disinfectant	14
Disinfectant/Sterilant	14
3 Year Warranty	15
Out of Warranty	15
End of Life	16
Portable Appliance Testing	16
Accessories	16
Fitting Accessories	17
Declaration of Conformity	
Final Inspection and Electrical Safety Test Report	Enclosed

ABOUT THIS MANUAL

This user Manual contains instructions which must be followed in order that the product is operated correctly.

GENERAL NOTES

1. Fill the tank prior to connection to power supply.
2. Connect only to a power supply with the corresponding voltage to that specified on the rating label positioned on the rear of the unit.
3. Ensure the power supply has a safety earth (ground) terminal.
4. Ensure the mains switch and power supply connector are accessible during use.
5. The mains supply cord fitted to this products is a heat resistant type and should be replaced by an equivalent type.
6. Do not block ventilation slots during use.
7. Always follow good laboratory practice by ensuring substances being heated present no risk of a hazard (explosion, implosion or release of toxic or flammable gases) or that these have been addressed. When heating substances where liberation of gases occurs suitable extraction should be used.
8. Use only liquids specified in this Instruction Manual within their specified temperature range. If the alarm lamp is illuminated the liquid temperature may be above its recommended maximum.
9. Use caution when topping up or draining the tank as the liquid in the tank may be very hot or cold.
10. Drain before moving the bath.
11. In the event of the over or under temperature alarm being illuminated do not touch the liquid as it may be very hot or cold. Use caution when refilling as a hot heating element can create scalding steam.
12. Always use a lid or layer of polypropylene spheres when operating at temperatures above 60°C. Take care when lifting the lid. Steam and hot vapours can cause scalding.
13. Always use the display or a thermometer to check the temperature - do not touch liquid.
14. If this product is not used in accordance with these instructions, then basic safety protection afforded by the water bath may be affected.
15. Check the operation of the over temperature device regularly NE4-HT models only.
16. If pumping to an external device ensure connecting pipe or hoses are suitable for the liquid and operating temperature. Ensure connections are secure.
17. Before using any cleaning or decontamination method except those recommended, check with your distributor that the proposed method will not damage the equipment.

AMENDMENTS

Issue 2	September	1992	MK2 Thermostirrer, revised instruction book.
Issue 3	June	1993	Digital display version introduced.
Issue 4	April	1995	Revised range DC and D merged.
Issue 5	May	1995	EMC approved.
Issue 6	May	1996	Address update.
Issue 7	July	1996	NE4-MT added to range.
Issue 8	June	1997	Bridge assy modified and SSR.
Issue 9	September	1997	NE4-25 added and pump ver included.
Issue10	December	1997	NE4's common bridge assy.
Issue 11	January	1998	Adaptor plate fitted making common fitting point.
Issue 12	August	1998	Multi-lingual instruction book.
Issue 13	September	2001	Addition NE4-D/CT range+layout updates.
Issue 15	August	2002	Improvements D+T, cover revision.
Issue 16	January	2004	Product Improvement PID controller: time and temperature control
Issue 17	November	2004	Product Improvement: Liquid Level
Issue 18	December	2004	Amendment to service dagram
Issue 19	March	2006	WEEE and Product improvement: Opt feature
Issue 20	November	2006	Anti-bacterial paint finish
Issue 21	June	2008	Improvement with n ew "FiLL" message feature.
Issue 22	June	2010	K30 2010 models.
Issue 23	January	2012	Updates.
Issue 24	January	2013	Addition of P.OFF to manual.
Issue 25	May	2013	NE4-D/CT range tank update.

SYMBOLS



HOT SURFACES

Paragraphs marked by this symbol indicate that a potential hazard to your personal safety exists from heated surfaces or other appendages on the outside or inside of the equipment.



CAUTION

This icon accompanies text and/or other international symbols dealing with potential damage to equipment. When present, it indicates that there is a potential danger of equipment damage may occur if information stated within the "CAUTION" paragraph is not adhered to or procedures are executed incorrectly.



PROTECTIVE EARTH OR GROUND TERMINAL

Protective earth conductor terminal.

LOCATION

The product must be placed on a smooth, level and sturdy work surface, preferably near a sink or drain for emptying. Use in a ventilated room. Suitable for use in ambient temperatures 5°C to 40°C with a maximum humidity 80% (temperature 31°C) decreasing to 50% (temperature 40°C). The product is designed for laboratory use.

UNPACKING

Remove the product from its packaging. Any damage please notify your dealer immediately. Retain the packaging over the warranty period.

NE4-8D, NE4-14D, NE4-22D,
NE4-28D

Box contains a digital thermostirrer mounted on a stainless steel bridge unit fitted to the selected size of stainless steel, stainless steel shelf, power lead and an instruction manual.

NE4-14D/CT, NE4-22D/CT

Box contains a digital thermostirrer mounted on a stainless steel bridge unit. A clear tank stainless steel shelf, clamping plate with screws, power lead and an instruction manual.

NE4-38D and NE4-56D

Box contains a digital thermostirrer mounted on a stainless steel bridge unit, 38 or 56 litre stainless steel tank, stainless steel shelf, power lead and an instruction manual. Fit the thermostirrer onto the tank and screw fit into place.

NE4-25D

Contents consist of an NE4-D thermostirrer mounted on a stainless steel bridge unit, deep chambered bath, stainless steel shelf, black nylon propellor, fasteners for securing the thermostirrer to the tank, power lead and an instruction book.

NE4-8P, NE4-14P, NE4-22P
NE4-28P

Box contains a digital thermocirculator mounted on a stainless steel bridge unit to fit the selected size of stainless steel tank, stainless steel shelf, power lead and an instruction manual.

NE4-D, NE4-P and NE4-HT

When purchased as a separate item an accessory NE4-MB mounting bracket is required. This allows a thermostirrer/thermocirculator to be fitted to any tank or vessel with a maximum wall thickness of 30mm.

SAFETY



Do not touch any electrical contacts or open any closure panels.

RISK OF ELECTRICAL SHOCK!

NE4-D, NE4-D/CT and NE4-P are Class 1 (IEC519 - Part 2) = low liquid level protection, reference to over temperature condition providing product over temperature protection.

NE4-HT Class 2 = Adjustable over temperature protection device and low liquid level protection.

POWER SUPPLY LEAD AND CONNECTION TO ELECTRICAL SUPPLY

Fit the power lead by plugging it into rear of the Thermostirrer/Thermocirculator and then to mains supply.



Before connecting the product to the electrical supply, check the information on the rating label is compatible.

IF IN DOUBT CONSULT AN ELECTRICIAN. THE PRODUCT MUST BE EARTHED!

Where the mains supply or plug connection differs refer to local regulations or qualified electrician.

ASSEMBLY NE4-D/CT models

1. Place digital thermostirrer mounted on stainless steel bridge onto right hand end of the clear tank.

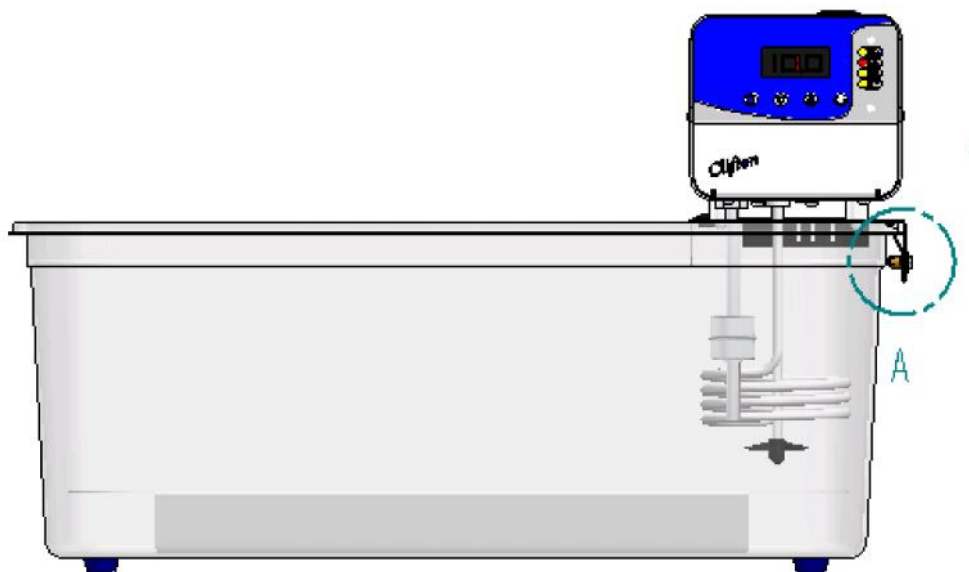

2. Place clamping plate inbetween the tank rim and stainless steel bridge - marked as "A" above.

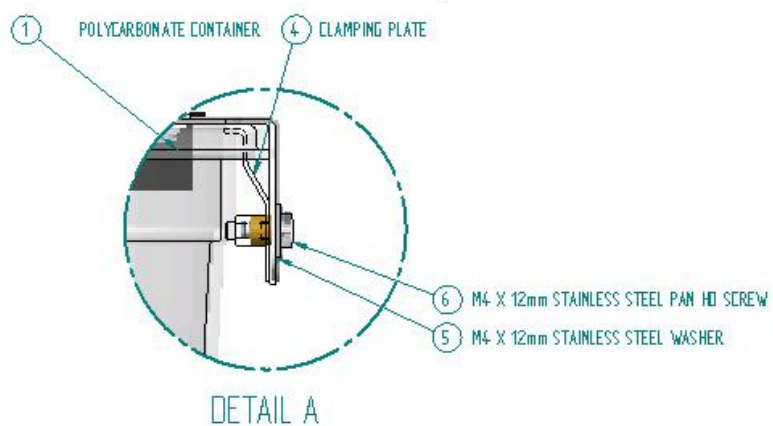

3. Fit screws into the bridge and clamping plate and tighten to secure the thermostirrer to the tank.
4. Place the stainless steel shelf in bottom of the tank.

NE4-D AND NE4-D/CT SERIES STIRRED DIGITAL PID BATHS

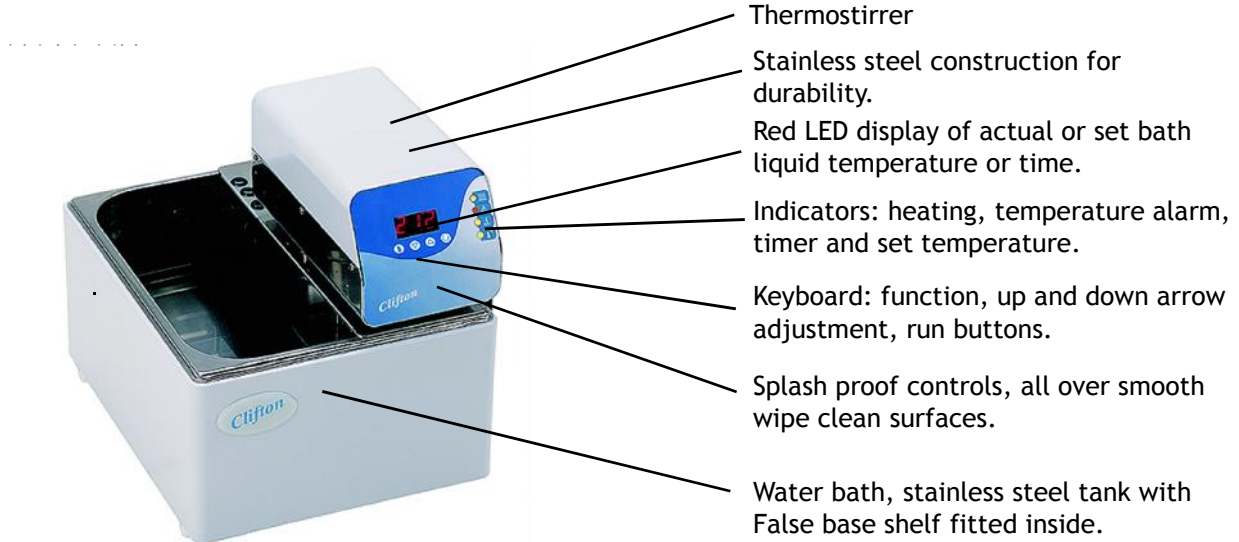

TANK VIEW

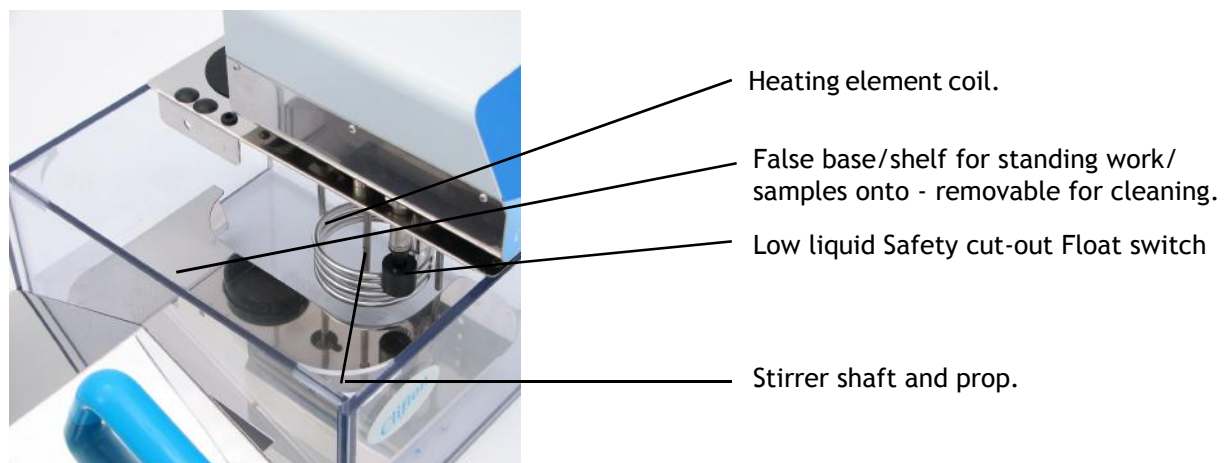

REAR VIEW

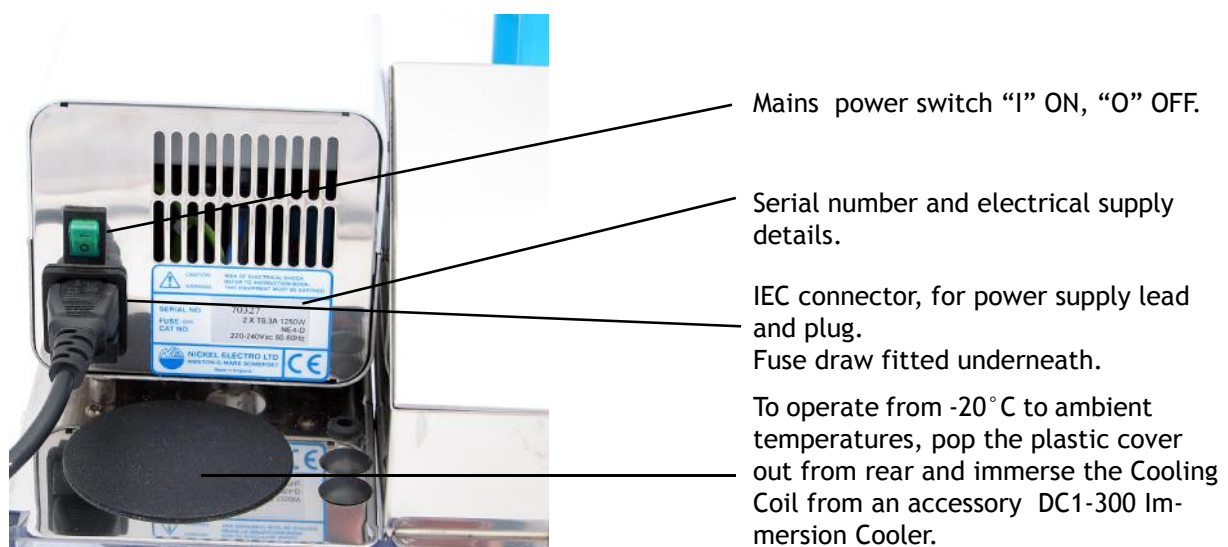

NE4-P AND NE4-HT SERIES CIRCULATOR DIGITAL PID BATHS

FRONT VIEW



- Thermocirculator.
- Stainless steel construction for durability.
- Red LED display of actual or set bath liquid temperature or time.
- Indicators: heating, temperature alarm, timer and set temperature.
- Keyboard: function, up and down arrow adjustment, run buttons.
- Splash proof controls, all over smooth wipe clean surfaces.
- Water bath, stainless steel tank with False base shelf fitted inside.

TANK VIEW

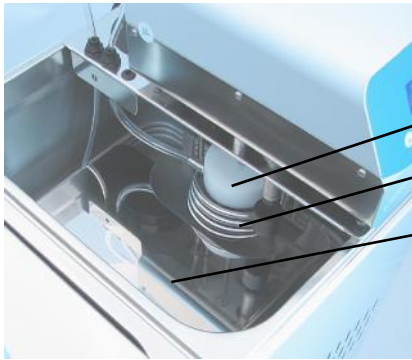

- Circulation pump - white.
- Heating element coil.
- False base/shelf.

REAR VIEW

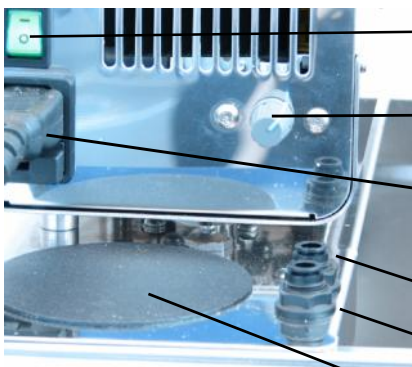

- Mains power switch "I" ON, "O" OFF.
- NE4-HT only - Safety Experiment Protector, can be set just above working temperature, protecting work or samples.
- IEC connector, for power supply lead and plug. Fuse draw fitted underneath.
- External Liquid Circulation, inlet and outlet ports, 'push fit and lock' fittings.
- OUTLET port - circulation
- INLET port - circulation
- To operate the Circulator from -20°C to ambient temperatures, pop the plastic cover out from rear and immerse the Cooling Coil from an accessory DC1-300 Immersion Cooler.

LIQUID LEVEL

8, 14, 22 Litre Baths	Minimum - must cover the top of the false base by 70mm Maximum - must not exceed the ridge in the tank.
28 + 56 Litre Baths	Minimum - must cover the top of the false base by 130mm. Maximum - must not exceed the ridge in the tank.
38 Litre Bath	Minimum - must cover the top of the false base by 130mm. Maximum - must cover the top of the false base by 190mm.
NE4-25D	Minimum - minimum level mark on tank.



When filling or emptying the bath disconnect the unit from the mains electrical supply.

SUITABLE LIQUIDS

Operating temperatures and recommended liquid options:

- 20°C to Ambient **100% Heat transfer liquid.** The LB range is formulated for temperatures from -45°C to 90°C and provides complete protection from freezing and algae growth and safeguards against corrosion. See accessories for the full range available.
100% car antifreeze (ethylene glycol).

Ambient to 99°C **Distilled water.**
Virkon dissolved in distilled water. Proven efficacy against bacteria, viruses, spores and fungi in a variety of independent tests using different protocols.
Heat transfer liquid. The LB range is formulated for temperatures from -45°C to 90°C and provides complete protection from freezing and algae growth and safe guards against corrosion. See accessories for the full range available.

99°C to 130°C For use above 99°C we recommend [NE4-HT series]:
Silicone oils [up to 10 centistokes].
Synthetic thermal liquids.



Above 60°C or below room temperature it is recommended that to achieve optimum performance the bath should be covered with SL4 lid or polypropylene spheres.

NE4-P AND NE4-HT SERIES CONNECTING CIRCULATED SUPPLY

This range of water baths are designed for external circulation of temperature controlled water in a closed circuit.

1. Turn unit off.
2. Inlet and Outlet 'push and lock' connectors are located on the rear of the bridge unit behind the thermocirculator. These are fitted with a factory fitted link which needs to be removed to fit the desired pipes/hoses.
2. Depress the collar on the 'push and lock' connectors to release the factory fitted link.
3. Push the desired pipes/hoses into the 'push and lock' connectors. Please note 6mm diameter hose is suitable. The pipe/hose will automatically be locked in place for secure external circulation.
4. To check the pipe/hoses for leakage prior to normal operation we suggest the following:
 - Fill the tank with water/oil.
 - Switch unit on.
 - Any leaks will now become apparent and the pipe/hose should be replaced.
 - Switch off and refit replacement hose. Please see page 11 for accessories hoses.

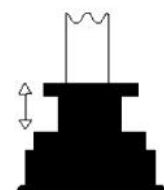
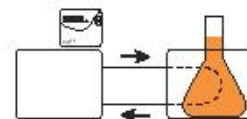

OPERATING INSTRUCTIONS

SWITCHING ON AND OFF

Switching ON - the unit may be turned ON (I) at the mains switch located at the rear. When ON (I) the switch is illuminated and unit performs a self test where all segments of the 4 digit LED display and indicators illuminate.

Switching OFF - the unit may be turned OFF(O) at the mains switch located at the rear. All temperature and time values remain in memory.

HEATING CONTROL MODES

The Clifton NE4 range feature an advanced PID temperature control.

CONTROL PANEL



KEY PAD DESCRIPTION



FUNCTION

- Press once "SP1" is displayed, temperature setting.
- Press twice "t" is displayed, timer setting.



DOWN ARROW

- Used to decrease a value. Hold continuously to scroll.
- When pressed for more than 1.5 seconds, "SP1" is displayed.



UP ARROW

- Used to increase a value. Hold continuously to scroll.



RUN

- When pressed for more than 1.5 seconds will activate/deactivate timer function.
- Used to turn off buzzer.

LED INDICATORS



HEATING INDICATOR

When LED is illuminated bath is being heated.



OVER AND UNDER TEMPERATURE ALARM INDICATOR

LED is illuminated when bath temperature is either 4°C above or 4°C below set temperature.



TIMER INDICATOR

- Continuous illumination indicates timer is set.
- Flashing illumination indicates timer is running back/counting down.



SET TEMPERATURE INDICATOR

- Continuous illumination indicates set temperature value is shown on display.

OPERATING INSTRUCTIONS

SETTING TEMPERATURE

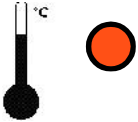
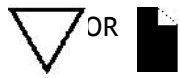

1. Press and hold the DOWN arrow for more than 1.5 seconds or press the FUNCTION button to display "SP1" the set temperature.

The 'set temperature' indicator will illuminate.

2. Use UP and DOWN arrow keys to select required temperature.

3. After setting temperature the display flashes between "SP1" and set temperature and will automatically revert to show actual liquid temperature.

Heater indicator will illuminate.

4. The over or under temperature alarm is automatically set 4°C above and 4°C below set temperature. **If the actual temperature rises or falls beyond this value the audible alarm and indicator are automatically activated.**

5. The Clifton water bath is now set and will heat and control the liquid to set temperature.

SETTING TIME



1. Press FUNCTION button until "t" appears on the display. It will then alternate between showing "t" and time - displayed as h:mm.

2. Press either UP or DOWN arrow to select desired number of hours.minutes.
- Minimum time setting is 0 hours and 01 minutes - displayed as 00.01
- Maximum time setting is 9 hours and 59 minutes - displayed as 9.59

3. Once the desired time is entered press the function button to confirm. Display reverts to actual liquid temperature.

TIMER OPERATION

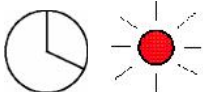
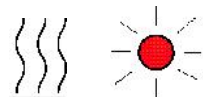

1. To start the timer press the RUN button for more than 1.5 seconds. The Timer automatically starts once bath temperature is at set temperature.

2. Heating indicator will illuminate continuously while liquid temperature is being raised to set point.

3. Heating indicator will flash when set temperature has been reached and is being maintained.

4. The timer indicator starts to flash showing the timer is running.

5. To view time remaining, press UP ARROW button until 't' appears and time remaining is displayed as h:mm.

6. An audible beeping and "End" message indicates timed period has finished. Press RUN button to deactivate buzzer and clear "End" message.

POWER INTERRUPT DURING TIMER MODE



If power is interrupted during timer mode, the display shows P.OFF when resumed. To clear, press and hold the RUN button until display reverts to actual temperature. Timer mode will then continue. To deactivate timer, press and hold RUN button.

EXPLANATION OF TEMPERATURE CONTROL TERMS

Temperature Calibration

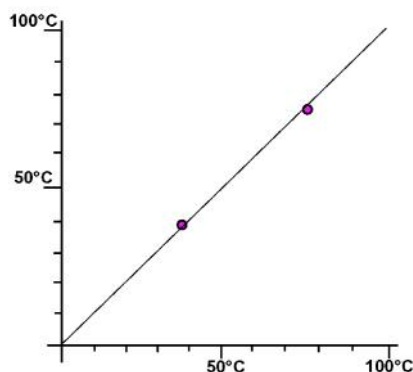

Verify the performance of the temperature control system digital display units undergo a factory calibration procedure which calculates the temperature values over the operating range of the equipment from 2 reference calibration points.

Accuracy

We do not provide, claim or assure any form of accuracy. Accuracy is defined as "the ability of a measurement to match the actual value of the quantity being measured". For accuracy we recommend using a calibrated reference probe at the actual set point temperature and where necessary, adjust the set point accordingly.

Sensitivity

For an explanation of sensitivity consider a unstirred digital water bath, the PID temperature control system measures and displays the actual temperature of the water and then compares it with the 'set point' temperature. It automatically calculates and adjusts the required quantity of heat into the bath to make the measured temperature equal to the set temperature. As with any process there is a time delay between measuring the temperature and the heat entering the water, which causes minor fluctuations in the temperature of the bath.

Heat is also distributed in an unstirred bath by convection and conduction and there are heat losses from the surface of the liquid which can cause temperature losses. These losses and heat distribution produce small fluctuations in temperature across the water in the bath.

These small temperature fluctuations at any one point are defined as "sensitivity" and vary between an upper and lower limit, however occasionally a larger variation can be observed. Sensitivity as stated in DIN 58966 is the temperature difference between the upper and lower temperature level over 100 cycles after removing the largest 25% of readings.

We determine sensitivity by recording the actual upper and lower temperatures of the bath using temperature loggers and is stated as plus or minus one half of the measured value.

Uniformity

Uniformity is calculated by measuring the temperature in opposing ends of the water bath and is the difference between the mean temperatures at these two points and stated as plus or minus half this value.

UNDER TEMPERATURE ALARM - AUTOMATICALLY SET

The under temperature alarm is automatically set 4°C below either 'Set Point 1' or 'Set Point 2'. When in alarm condition the 'over and under temperature' alarm indicator illuminates and actual bath temperature is shown. Please note if an accessory DC1-300 dip cooler is fitted cooling will continue. Once water temperature has risen above alarm setting then indicator clears and actual bath temperature is displayed.



Always investigate the cause of the Under Temperature Alarm.

OVER TEMPERATURE ALARM - AUTOMATICALLY SET

The over temperature alarm is automatically set 4°C above either 'Set Point 1' or 'Set Point 2'. When in alarm condition the 'over and under temperature' alarm indicator illuminates and actual bath temperature is shown. All heating/cooling is switched off. Please note if an accessory DC1-300 dip cooler is fitted cooling will continue. Once water temperature has fallen below alarm setting then indicator clears and actual bath temperature is displayed. When in alarm condition the motor and heater are switched off on NE4-P and NE4-HT. NE4-D models motor remains on but heater is switched off.



Always investigate the cause of the Over Temperature Alarm.

SAFETY EXPERIMENT PROTECTOR - HT RANGE ONLY

To set the safety device:

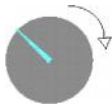

1. Safety device knob (located on the rear) is turned fully clockwise.



2. Set the temperature on the temperature controller at which temperature you require the device to operate, using instructions for set point 1 (see page 6). Allow the liquid to reach this temperature and settle.

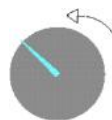

3. Slowly turn the knob back anticlockwise until it clicks.



4. Adjust the temperature on the temperature controller to the actual required operating temperature - value less than set in 2 above. When in alarm condition heater is switched off and the motor remains on.

LOW LIQUID LEVEL FLOAT SWITCH - ALL MODELS - "FiLL" MESSAGE DISPLAYED

The bath features a low liquid level alarm - the display will show "FiLL" in this condition. Heating will be switched off if the liquid level falls below the recommended level. The stirring action will continue. To reset the Low liquid level warning - top up liquid level



Use caution when refilling the tank as hot elements can spit and create scalding steam.

PERIODICAL CHECK

The low liquid level float switch should be checked periodically by lowering the level of liquid in the tank and a "FiLL" message should appear. In the event that this does not occur please contact our service department. The Safety Experiment Protector featured on the NE4-HT should be routinely checked for correct operation where used. Follow set up instructions as described above.

CLEANING

GENERAL



Important - please follow these instructions to avoid possible damage to the unit, otherwise affecting its performance and warranty. Always disconnect the product from the electrical supply before cleaning.

CLEANING EXTERNAL PAINTED SURFACES FEATURING “ANTI-BACTERIAL PAINT FINISH”

The water bath should be cleaned at regular intervals wiping external surfaces with a cloth or sponge soaked in warm soapy water with a mild detergent. All surfaces should be cleaned using a soft cloth or sponge.



Do not under any circumstances use strong solvents or solutions containing Chlorinated Hydrocarbons, Esters, Ketones or abrasive cleaners or polish on the paint finish otherwise it damages the built in anti-bacterial properties.

Painted surfaces and controls on Clifton NE4 range features an “Anti-bacterial paint finish” identified with this authenticating logo on the unit. This “Anti-bacterial finish” inhibits the growth of bacteria. It has been tested by independent specialist test houses such as the Law Laboratories (in the UK) using internationally recognized test methods and proven to be effective versus a wide range of bacteria species including Escherichia coli and Staphylococcus aureus (MRSA).

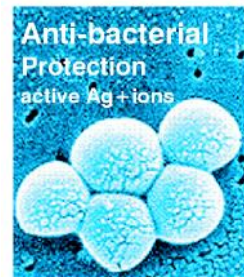

We recognise hygienic surfaces are part of a controlled approach to a cleaner working environment. Within its formulation an active ingredient with proven anti-bacterial properties is bound into the finish. The efficacy of the finish applied to the Clifton range is maintained over its lifetime, as the anti-bacterial agent is integral within the finish.

In a laboratory environment it makes this one less source of contamination, contributing to essential clean working practices. A benefit of such a finish can lead to a reduction in cleaning schedules because surfaces are more protected and improves protection between cleaning. Unlike detergents “Anti-bacterial finish” does not offer an instantaneous action, but is intended for long-term general protection against bacterial growth.

Moisture on the painted surface is necessary for the bacterium to absorb the agent and be affected by it. The coating is therefore less active in very dry conditions, but dependent upon relative humidity, moisture in the atmosphere maintains activity. Areas where moisture is trapped are also areas that normally are difficult to clean and where bacteria proliferate but these areas are most active for the anti-bacterial coating improving the defence against bacterial growth.

Cleaning the Stainless Steel Tank

The stainless steel crevice free tank with smooth corners should provide years of valuable service and is resistant to chloride containing solutions it is however important to avoid high concentrations of halogens - especially chloride. With such a high quality and resistant tank it may show symptoms of these halogens as rust, which are deposits from external sources in the water supply.

We recommend always empty the bath of liquid after use and wipe out the internal faces of the tank with a non-abrasive cloth and allow to dry. Any deposits can be removed with nitric acid (10%) on a cloth. **WEAR PROTECTIVE EQUIPMENT!**

It is also recommended to use an accessory lid to prevent contaminants landing in bath liquids.

DESCALING THE STAINLESS STEEL TANK

Descal the stainless steel tank regularly to maintain it in as new condition ensuring the corrosion resistance and normal operating conditions are maintained throughout its working life. Descal by adding 1 litre of vinegar to water and gently heating to 50°C for an hour, empty and brush the lime away.

Rinse thoroughly afterwards.

DECONTAMINATION OF EQUIPMENT

Clifton laboratory equipment can be decontaminated after spillage or contact with potentially HIV and Hepatitis infected blood samples during analysis using following recommended rapid disinfectants.

VIRUCIDAL DISINFECTANT

We recommend Virkon tablets for the safe and rapid disinfection of equipment in a wide variety of situations available from your distributor or contact Day-Impex Ltd. for more details. Telephone: 44+(0)1787 223232 or <http://www.day-impex.co.uk>

The ultimate high level surface disinfectant, dissolve VIRKON in water, providing a safe working solution with a faint lemon odor. It has proven efficacy against bacteria (including mycobacteria), viruses, spores and fungi in a variety of independent tests using different protocols. Presents no serious long term health risks to staff - obviating the need for costly ventilation equipment and health monitoring. Also provides high level disinfection of laboratory equipment and instruments where autoclaving is neither practical nor necessary. For more detailed information relating to how Virkon should be used with access to test reports www.relyon.dupont.com



Is Virkon solution corrosive? Virkon solution requires only 10 minutes contact time to be effective so long-term exposure is not necessary and therefore will not corrode most materials. Care should be taken with Stainless steel water bath tanks, these surfaces should not be affected however, it is important that generally you do not leave Virkon solution in contact with metal surfaces "FOR LONGER THAN IS NECESSARY".

Virkon is Registered in accordance with the requirements of the Medical Devices Directive, (93/42/EEC) as a Medical Device.

DISINFECTANT/STERILANT

We recommend PeraSafe a powder product for the safe and rapid chemical sterilant of equipment in a wide variety of situations available from your distributor or contact Day-Impex Ltd for more details. Telephone: 44+(0)1787 223232 or <http://www.day-impex.co.uk>

PeraSafe has a proven safety profile for end-users with none of the undesirable properties of skin sensitisation, toxic fumes or unpleasant odours that are associated with aldehyde solutions.

Leading UK and USA microbiologists have proven PeraSafe to be active against viruses, mycobacteria and fungi. It is microbiologically superior to glutaraldehyde, destroying sporing bacteria in one minute. It has also been independently proven that PeraSafe sterilises in just 10 minutes.



For more detailed information relating to how PeraSafe should be used with access to test reports www.relyon.dupont.com

3 YEAR WARRANTY

Our service engineers are fully trained in the assembly, calibration and servicing of all Clifton instrumentation. Products can be returned to our comprehensively equipped service centre where a fast and efficient turnaround is guaranteed:

Service Department, Nickel Electro Limited, Oldmixon Crescent, Weston-super-Mare, North Somerset BS24 9BL, UK. Tel +44 (0)1934 626691 Fax +44 (0)1934 630300.

OUT OF WARRANTY

Our Service Department has comprehensive stock of chargeable spare parts maintaining working life of equipment or units can be returned for quotation before repairs are undertaken.

END OF LIFE



This symbol indicates that this product should not be disposed of with your waste. Instead, dispose waste electrical equipment by handing it over to a designated collection point for the recycling of waste electrical and electronic equipment. The separate collection and recycling of your waste equipment at the time of disposal will help to conserve natural resources and ensure that it is recycled in a manner that protects human health and the environment. For more information about where you can drop off your waste equipment for recycling, in UK please contact Service Department, rest Europe contact your Distributor.

Health & Safety, unless in receipt of a Decontamination Notice or Report the unit cannot be returned or accepted for disposal.

Clifton electrical and electronic equipment has been designed for recycling and takes into account the dismantling and recovery its components and materials. Clifton products are easily recycled with majority of the product constructed from stainless or mild steels, which can readily be re-used or recycled.

In excess of 78% of this product range can be easily re-cycled economically.

PORTABLE APPLIANCE TESTING

When conducting testing, ensure it is conducted by a qualified person.



DO NOT PAT TEST THE BATH UNLESS IT CONTAINS WATER.

THIS EQUIPMENT MUST NOT BE FLASH TESTED!

ACCESSORIES FOR NE4 SERIES

Stainless Steel Gable Lids

- SL4-8 Stainless Steel Gable Lid to suit 8 Litre Baths
- SL4-14 Stainless Steel Gable Lid to suit 14 Litre Baths
- SL4-22 Stainless Steel Gable Lid to suit 22 and 28 Litre Baths
- SL4-38 Stainless Steel Gable Lid to suit 38 Litre Baths



Stainless Steel Flat Lids

- LD4-8 Flat One Piece Stainless Steel Lid to suit 8 Litre Capacity Bath
- LD4-14 Flat One Piece Stainless Steel Lid to suit 14 Litre Capacity Bath
- LD4-22 Flat One Piece Stainless Steel Lid to suit 22 and 28 Litre Capacity Bath
- LD4-38 Flat One Piece Stainless Steel Lid to suit 38 Litre Capacity Bath



Stainless Steel Raised Shelves

- RS4-14 Stainless Steel Raised Shelf to suit 14 Litre Baths
- RS4-22 Stainless Steel Raised Shelf to suit 22 and 28 Litre Baths

Immersion Cooler

- DC1-300 Immersion Dip Cooler - cooling liquids down to -20°C
- DC2-300 Immersion Dip Cooler - cooling liquids down to -20°C



Stainless Steel Test Tube Racks - Dimensions 270 x 70 x 138mm (L x W x H))

- 6870 Stainless Steel Test Tube Rack 26 Hole x 17mm Diameter
- 6871 Stainless Steel Test Tube Rack 16 Holes x 26mm Diameter
- 6872 Stainless Steel Test Tube Rack 36 Holes x 13mm Diameter
- 6873 Stainless Steel Test Tube Rack 18 Holes x 19mm Diameter/suitable for 1.5ml microtubes
- 6875 Stainless Steel Test Tube Rack 50 Holes x 32mm Diameter
22/28 Litre = 1 Rack, 38 Litre = 2 Racks and 56 Litre = 4 Racks
- 6900 Stainless Steel Test Tube Rack 12 Holes x 32mm Diameter
Note: 8 Litre = 1 Rack, 14 Litre = 3 Racks, 22 and 28 Litre = 5 Racks
38 Litre = 7 Racks and 56 Litre = 10 Racks



Miscellaneous

- LB-2.5 2.5 Litres - Lab Bath 4590 - Heat transfer fluid - Temperature range -15° to +90°C
- LB-5.0 5 Litres - Lab Bath 4590 - Heat transfer fluid - Temperature range -15° to +90°C
- TC-1 Thermometer Clip Complete With Bent Stem Spirit Filled Thermometer
- BX0616 Draining Syphon
- NE4-MB Mounting Bracket allows Thermostirrers or Thermocirculators to be mounted on any type of separate tank.
- HS-1 Push Fit Insulated Hoses 1m length.
- HS-2 Push Fit Insulated Hoses 2m length.
- BP0368 Polypropylene Spheres
- CAL Calibration Record



For more information on Accessories www.nickel-electro.co.uk



EC Declaration of Conformity

We herewith confirm the following product

NE4 Stirred Waterbath Range

Conforms with the requirements outlined by following European Directives.

Low Voltage Directive (73/23/EEC)
EMC Directive (89/336/EEC)

We confirm the declaration

NICKEL-ELECTRO LTD

Manufacturers of laboratory, medical and clinical equipment.

Oldmixon Crescent, Weston-super-Mare,
North Somerset, BS24 9BL, United Kingdom.

Tel: +44 (0)1934 626691

Fax: +44 (0)1934 630300

Email: clifton@nickel-electro.co.uk

www.nickel-electro.co.uk



Conforms with the requirements of following Standards

BS EN 61010:1

BS EN 61010:2.010

Safety requirements for electrical equipment for measurement, control and laboratory use.

BS EN 61326

Electrical equipment for measurement control and laboratory use - EMC requirements.

Nickel-Electro Ltd is also registered ISO9001 reference No. Q09820





NICKEL-ELECTRO Ltd.

Manufacturers of laboratory, medical and clinical equipment.

Oldmixon Crescent, Weston-super-Mare,
North Somerset, BS24 9BL, United Kingdom.

Tel: +44 (0)1934 626691
Fax: +44 (0)1934 630300

Email: clifton@nickel-electro.co.uk
www.nickel-electro.co.uk