

GR SERIES

Analytical Balances

INSTRUCTION MANUAL

GR-120

GR-200

GR-300

GR-202

 is a hazard alert mark.

NOTE

This manual and/or the GR series balances may be changed at any time to improve the product without notice.

© 2001 A&D Company Ltd. All rights reserved.

No part of this publication may be reproduced, transmitted, transcribed, or translated into any language in any form by any means without the written permission of A&D Company, Ltd.

The contents of this manual and the specifications of the instrument covered by this manual are subject to change for improvement without notice.

Product names and company names mentioned in this manual are trademarks or registered trademarks of their respective companies in Japan or other countries and regions.



Contents

1.	Introduction	5
1.1.	Features	5
1.2.	Compliance with FCC Rules	5
2.	Caution	6
2.1.	Precautions for Installing the Balance	6
2.2.	Cautions during Use (To Get Best Performance)	7
2.3.	Take Care of Your Balance	8
2.4.	Power Supply	8
3.	Unpacking Your Balance	9
3.1.	Installing Your Balance	10
3.2.	Display Symbols and Key Operation	10
4.	Weighing Units	11
5.	Weighing	12
5.1.	Basic Operation (Gram Mode)	12
5.2.	Counting Mode (PCS)	13
5.3.	Percent Mode (%)	13
6.	Response Adjustment	14
6.1.	Automatic Response Adjustment	14
6.2.	Manual Response Adjustment	15
7.	Calibration	15
7.1.	Automatic Self Calibration	17
7.2.	Calibration Using the Internal Weight	17
7.3.	Calibration Test Using the Internal Weight	18
7.4.	Calibration Using an External Weight	19
7.5.	Calibration Test Using an External Weight	20
7.6.	Correcting the Internal Weight Value	21
8.	Function Switch and Initialization	22
8.1.	Permission or Prohibition	22
8.2.	Initializing the Balance	23
9.	Function Table	24
9.1.	Display and Keys of the Function Table	24
9.2.	Details of the Function Table	25
9.3.	Explanation of Item "Environment, Display"	27
9.4.	Explanation of Item "Data output mode"	28
9.5.	Explanation of Item "Data format"	29
9.6.	Examples of Data Format	31
10.	ID Number and GLP Report	33
10.1.	Main Objectives	33
10.2.	Setting the ID Number	33
10.3.	GLP Output	34
11.	Data Memory Function	39
11.1.	Use and the Method of Storing Data	39
11.2.	Preparation of the Function Table	40
11.3.	Enabling data memory function	40

11.4.	Output of Data from Memory	40
11.5.	Deleting All Data at One Time.....	41
12.	Underhook	41
13.	Specific Gravity (Density) Measurement	42
14.	Input and Output Interface	46
14.1.	RS-232C Interface	46
14.2.	External Contact Input	47
15.	Connection to Equipment.....	48
15.1.	Connection to AD-8127 Printer	48
15.2.	Connection to AD-8121B Printer.....	48
15.3.	Connection to Computer	50
16.	Commands.....	52
16.1.	Command List.....	52
16.2.	Commands to Request Weighing Data	53
16.3.	Commands to Control the Balance.....	54
16.4.	Commands to Request Memory Data	55
16.5.	Acknowledge Code and Error Codes	56
16.6.	Control using CTS and RTS	56
16.7.	Related Settings.....	56
16.8.	Command Examples.....	57
17.	Maintenance	60
17.1.	Treatment of the Balance.....	60
17.2.	Error codes	60
17.3.	Other Display	61
18.	Specifications	62
18.1.	External Dimensions	63
18.2.	Optional Accessories	64



1. Introduction

THANK YOU FOR YOUR A&D PURCHASE

This manual will tell you in simple language how this balance works and how to get the most out of it in terms of performance.



1.1. Features

- Built-in Calibration Weight (internal weight), used to calibrate and verify the calibration of your balance.
- Automatic Self Calibration, using the built-in weight, adapting to changes in temperature.
- Automatic Response Adjustment, adapting to vibration and drafts in the environment.
- Data Memory Function, storing 200 weighing data.
- Interval Memory Mode, storing weighing data periodically.
- Good Laboratory Practices (GLP) data output using a serial interface.
- Under Hook, for measuring specific gravity and magnetic substances.
- The balance is equipped with the specific gravity measuring mode to calculate the specific gravity (density) of a solid.
- Multiple Weighing Units, with most of the common units used around the world.
- RS-232C serial interface, for transmitting data and controlling your balance.
- Windows communication tools software (WinCT) to allow easy communication with a computer using Windows. The current version of the WinCT can be downloaded from the A&D website.
- Door Control Lever, a front mounted door control can easily open and close one of the side doors if connected using the door joint.



1.2. Compliance with FCC Rules

Please note that this equipment generates, uses and can radiate radio frequency energy. This equipment has been tested and has been found to comply with the limits of a Class A computing device pursuant to Subpart J of Part 15 of FCC rules. These rules are designed to provide reasonable protection against interference when equipment is operated in a commercial environment. If this unit is operated in a residential area it might cause some interference and under these circumstances the user would be required to take, at his own expense, whatever measures are necessary to eliminate the interference.

(FCC = Federal Communications Commission in the U.S.A.)



2. Caution



2.1. Precautions for Installing the Balance

To ensure that you get the most from your balance, please try to follow these conditions as closely as possible:

- The best operating temperature is about 20°C / 68°F at about 50% Relative Humidity.
- Try to ensure a stable power source when using the AC adapter.
- Please warm-up the balance for at least one hour. Plug-in the AC adapter as usual.
- The weighing room should be free of dust.
- The weighing table should be solid and free from vibration, drafts (such as frequently opening doors or windows) and as level as possible.
- Keep the balance level by using the bubble spirit level.
- Don't install the balance near heaters or air conditioners.
- Don't install the balance in direct sunlight.
- Don't use the balance near other equipment which produces magnetic fields.
- Corners of rooms are best as they are less prone to vibrations.
- Calibrate the balance before using and after moving it to another location.



Do not place or use the balance where there is flammable or corrosive gas present.

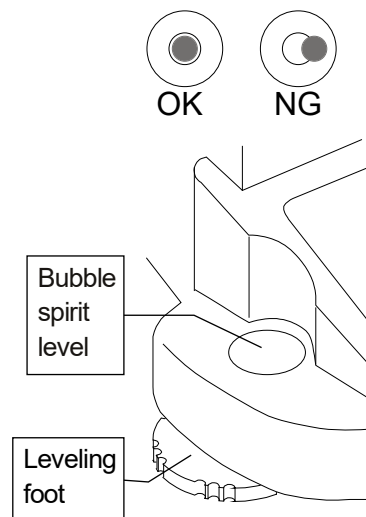



2.2. Cautions during Use (To Get Best Performance)

For precise and accurate weighing, please take notice of the following.

- Weighing errors may occur due to the influence of static electricity. Note that if the ambient humidity drops below 45%RH, insulators such as plastics are liable to have static electricity. Ground the balance and perform the following as needed.
 - Eliminate the static electricity using the optional AD-1683A.
 - Increase the relative humidity at the place where the balance is installed.
 - Weigh the sample in a conductive metal container or the like.
 - Wipe off charged materials such as plastic with a damp cloth to suppress static electricity.
- Influence of magnetism may cause weighing errors. When measuring magnetic materials (iron, etc.), keep the sample away from the balance main body by means such as underhook weighing.
- Weighing errors may occur if there is a difference between the ambient temperature and temperature of the sample (and the container). For example, when the room temperature is 20°C, convection occurs around a Petri dish or watch glass that is 40°C and the balance displays a value lighter than the actual weight. Before weighing the sample and the container, try to acclimatize them to the ambient temperature. Use tweezers when handling the sample.
- Perform the weighing operation carefully and quickly. If measurement takes a long time, error-inducing factors will increase due to changes in temperature and humidity in the weighing chamber, air turbulence or reaction/humidity absorption by the sample. It is advisable to use long tweezers to avoid inserting your hands into the weighing chamber.
- For weighing with 0.01 mg readability using the GR-202, it is advisable to install the fine range breeze break ring in place of the breeze break ring. (Refer to “3. Unpacking your balance”.) By installing it, the influence of air flow can be minimized.
- When placing a sample on the weighing pan, do not drop it, or do not place a sample greater than the balance weighing capacity. Place the sample in the center of the weighing pan.
- When pressing keys, do not press with a sharp object such as a pen. Instead, press the center of the key with your finger.
- Be sure to press the **RE-ZERO** key before weighing in order to eliminate measurement errors.
- Measurement results include error from air buoyancy. The buoyancy of air varies depending on the sample volume, atmospheric pressure, temperature, and humidity. Correct the buoyancy for the most precise measurement.
- Prevent foreign substances such as powder, liquid, and metal pieces from entering the balance.

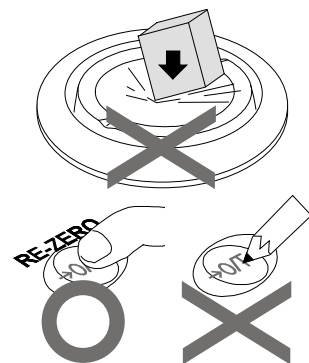
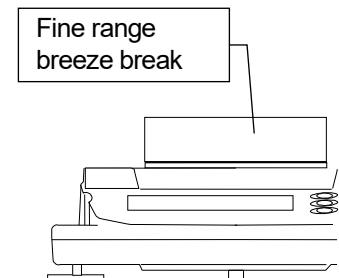
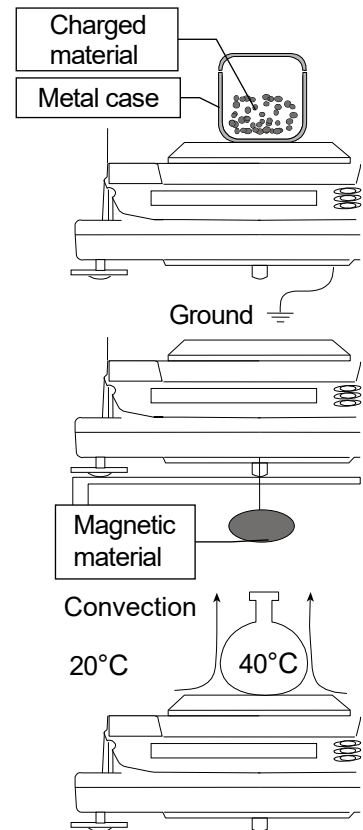



2.3. Take Care of Your Balance

- Don't disassemble the balance. Contact your local A&D dealer if your balance needs service or repair.
- Don't use solvents to clean the balance. For best cleaning, wipe with a dry lint free cloth or a lint free cloth that is moistened with warm water and a mild detergent.
- When you transport the balance, hold it as shown in the right illustration. Never lift the balance using the weighing chamber frame.
- Keep magnetic substance away from the balance.
- Avoid mechanical shock to your balance.
- Avoid dust and water so that the balance weighs correctly. Protect the internal parts from liquid spills and excessive dust.
- Remove and clean the floor plate of the weighing chamber.
- Use the special shipping box supplied for transportation.

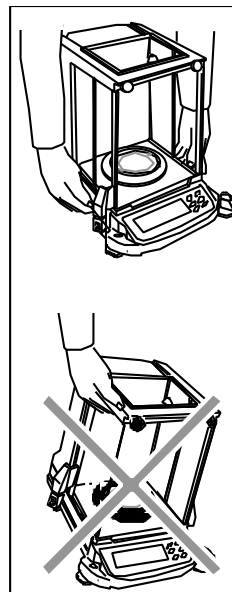

2.4. Power Supply

- Do not remove the AC adapter while the internal mass is in motion, for example, right after the AC adapter is connected, or during calibration using the internal mass.
If the AC adapter is removed under the conditions described above, the internal mass will be left unsecured, that may cause mechanical damage when the balance is moved.
Before removing the AC adapter, press the **ON:OFF** key and confirm that zero is displayed in weighing mode.
- When the AC adapter is connected, the balance is in the standby mode if the standby indicator is on (see "3.2. Display Symbols and Key Operation "). This is a normal state and does not harm the balance. We recommend that you plug in your balance for at least an hour before use so it can warm up.



3. Unpacking Your Balance

Unpack the balance carefully and keep the packing material if you want to transport the balance again in the future. In the carton you should find this manual plus:

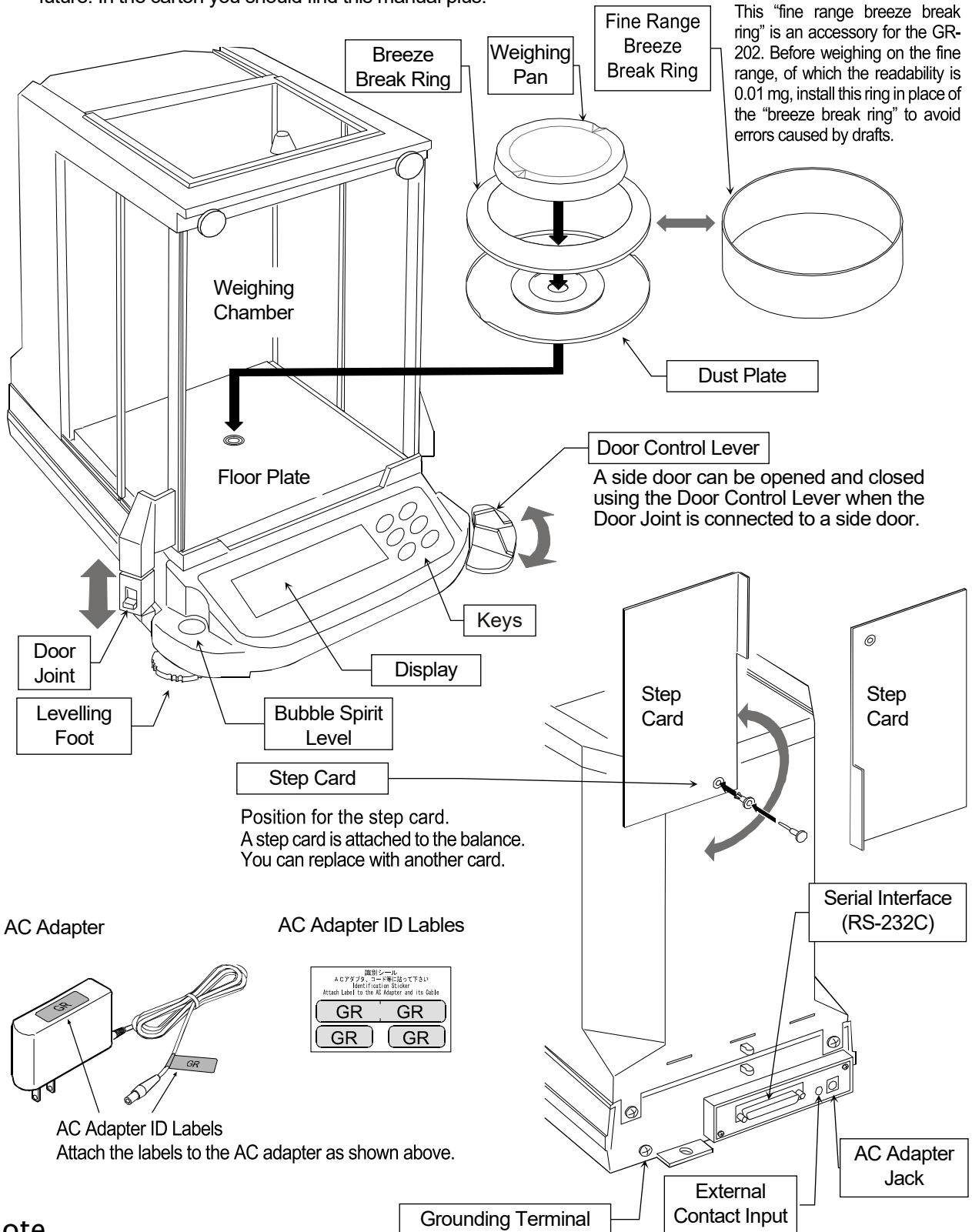

Note

- Please confirm that the AC adapter type is correct for your local voltage and receptable type.
- Please use the dedicated AC adapter specified for the balance.
- If you use the wrong AD adapter, the balance and other equipment may not operate properly.



3.1. Installing Your Balance

- Step 1 Consider the section "2. Caution" for installing your balance.
- Step 2 Assemble the "Dust Plate", "Breeze Break Ring / Fine Range Breeze Break Ring" and "Weighing Pan" on your balance. There is a reference illustration on the previous page.
- Step 3 Adjust the level of the balance using the leveling feet.
- Step 4 Connect the AC adapter to the balance. Warm up the balance for at least one hour with nothing on the weighing pan.



3.2. Display Symbols and Key Operation

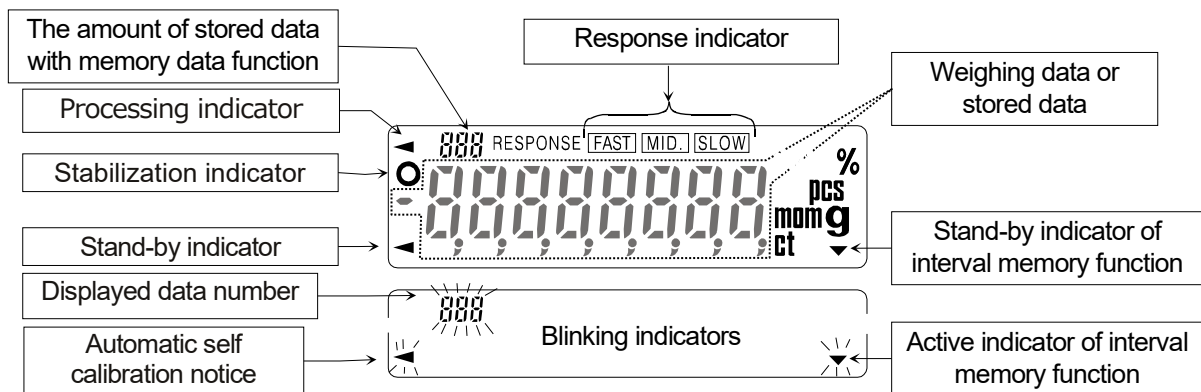

There are two types of key operations: "press and release" and "press and hold". The function of each key changes depending on how the key is pressed. Do not press and hold a key unless necessary.



Key	Press (press and release) the key	Press and hold the key
ON:OFF 	Display ON / OFF key. The stand-by indicator is displayed, when the balance is turned off with this key. Weighing data is displayed, when the balance is turned on with this key.	
RANGE 	□ Readability of weighing data is changed.	The function table menu is displayed. Refer to section "9. Function Table".
MODE 	Units are changed (selected from the function table). Refer to section "4. Weighing Units".	Response adjustment is performed.
CAL 	This key performs calibration of the balance using the internal weight.	Other items of the calibration menu are displayed.
PRINT 	Weighing data is stored in the balance (Factory setting) or is output to the RS-232C interface. This key functions according to the function table.	Data memory menu or GLP menu is displayed. This key functions according to the function table. Factory setting is "not used".
RE-ZERO 	The key sets the display to zero. This key returns a weighing value to the center of zero when the weighing pan is empty, and can also tare (cancel) the weight of container and/or sample. Please use this key before each weighing to cancel possible error.	



4. Weighing Units

The most common unit of weight used around the world is grams, but there is often a need to shift to an alternative unit specific to the country where the balance is used or to select modes such as counting or percent.

The unit can be selected by the function table. The units are as follows (if some are missing, please refer to your dealer):

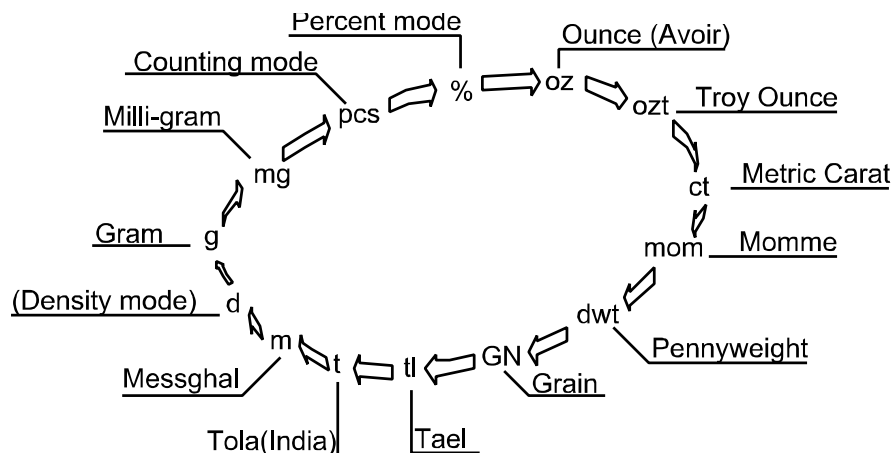

If a mode (or unit) of weight has been turned off, the sequence will be missing that mode or unit. There are also the various Tael that can be included if necessary. (Tael is selected as a unit from four units installed at the factory)

Note

If the law in your area permits, you may use all of the units, or at this software level you can disable the weighing units you don't regularly use. Also, some dealers may initially turn OFF units which are not regularly used, but you may want to turn them back on.

Conversion table

Abbrev.	Name	Conversion
mg	Milli-gram	0.001 g
oz	Ounce (Avoir)	28.349523125 g
ozt	Troy Ounce	31.1034768 g
ct	Metric Carat	0.2 g
mom	Momme	3.75 g
dwt	Pennyweight	1.55517384 g
GN	Grain (UK)	0.06479891 g
TL	Tael (HK general, Sing.)	37.7994 g
TL	Tael (HK, jewelry)	37.429 g
TL	Tael (Taiwan)	37.5 g
TL	Tael (China)	31.25 g
t	Tola (India)	11.6638038 g
mes	Messghal	4.6875 g

Operation of unit selection

The unit can be selected in the function table. The sequence of displaying the unit can be arranged so as to fit the frequency of use in the function table. According to the sequence of displaying unit, the units can be changed with the **MODE** key at the weighing mode.

Selecting a unit and arranging the sequence of display

- Step 1 Press and hold the **RANGE** key to **bASFnC** of the function table.
- Step 2 Press the **RANGE** key several times to display **Unit**.
- Step 3 Press the **PRINT** key to enter into unit selection.
- Step 4 The unit can be selected using the following keys.
The unit display sequence is in the order of pressing the **RE-ZERO** key.
MODE key: The key to sequentially display the units.
RE-ZERO key: The key to select a unit. The indicator is displayed at unit selected.
- Step 5 Press the **PRINT** key to store the units. Then the balance displays next menu **id** of the function table.
- Step 6 Press the **CAL** key to exit the function table. Then the balance returns to the weighing mode.



5. Weighing

Cautions for the weighing operation

- Operate your balance gently.
- Press the **RE-ZERO** key to prevent possible error before placing material on the pan (weighing material) each time.
- Shorten the operation time as much as possible. (Opening and closing door, placing and removing material)
- Temperature changes during measurement may cause weighing error.
- Use a pair of tweezers (pincette) to avoid a temperature change that is due to having your hand in the weighing chamber.
- Calibrate your balance periodically to maintain weighing accuracy. Refer to section "7. Calibration".
- Electrified material or magnetic body may cause a weighing error.
- Do not press keys with a sharp instrument (such as a pencil or ball point pen).
- Do not drop things on the pan, or place a weight on the pan that is beyond the weighing range of the balance.
- Keep the area clean and dry.
- Consider section "2. Caution" for weighing operation.



5.1. Basic Operation (Gram Mode)

- Step 1 Calibrate your balance before use. (Refer to section "7. Calibration")
- Step 2 Place a container on the weighing pan, if necessary.
Press the **RE-ZERO** key to cancel net weight. The balance displays zero.
Container: A vessel placed on the pan, but not to be included in the weighing data.
- Step 3 Place material on the pan or in the container.
- Step 4 Wait for the stabilization indicator to be displayed and read the value.
- Step 5 Remove the material and container from the pan.



5.2. Counting Mode (PCS)

Selecting the counting mode

- Step 1 Select the unit "pcs" using the **MODE** key. If the counting mode can not be selected, refer to section "4. Weighing Units". (pcs : pieces)

Storing a unit weight

- Step 2 Press the **RANGE** key to enter the sampling mode.
- Step 3 If you want to select the number of items to be used for the sample, press the **RANGE** key (several times). It may be set to 10, 25, 50 or 100.
- Step 4 Place a container on the weighing pan, if necessary. Press **RE-ZERO** key to cancel this weight. ex. **25 pcs** is displayed in the case of 25 items.
- Step 5 Place items on the pan. This number of items is the same quantity as the number displayed (10, 25, 50 or 100).
- Step 6 Wait for the stabilization indicator to come on. Press the **PRINT** key to calculate the unit weight and store it.

Counting items

- Step 7 You are now able to count the items by placing them on the pan.

Counting mode using the ACAI function

ACAI™ (Automatic Counting Accuracy Improvement™) is a function that improves the accuracy of the unit weight.

- Step 8 If you add a few more items, the ACAI indicator turns on. (The ACAI indicator turns off if in overload)
- Step 9 The balance re-calculates the unit weight while the ACAI indicator is blinking. Wait and do not touch the items on the pan until the ACAI indicator turns off automatically.
- Step 10 You are now able to count items with a more accurate unit weight.
- Step 11 If you add a few more items, proceed to step 8.
The balance re-calculates a more accurate unit weight.



5.3. Percent Mode (%)

Selecting the unit of percent mode

- Step 1 Select the unit **%** using the **MODE** key. If the percent mode can not be selected, refer to section "4. Weighing Units". (%: percent)

Storing 100% weight

- Step 2 Press the **RANGE** key to enter the sampling mode.
- Step 3 Place a container on the weighing pan, if necessary.
Press the **RE-ZERO** key to cancel the container weight and possible error.
The balance displays **100.0**.
- Step 4 Place the item of 100% weight on the pan or in the container.
- Step 5 Press the **PRINT** key to store this 100% weight.
- Step 6 Remove the item from the pan.

Reading percentage

Step 7 You are now able to read the percentage based on the stored 100% weight.



6. Response Adjustment

This function stabilizes the weight value, reducing the influence on weighing that is caused by drafts and/or vibration at the place where the balance is installed. This function adjusts by automatically analyzing the environment or by hand-operation. The function has three stages as follows:

Indicator	Function table	Summaries
FAST	[Cond 0]	Fast response, Sensitive value
MID.	[Cond 1]	
SLOW	[Cond 2]	Slow response, Stable value

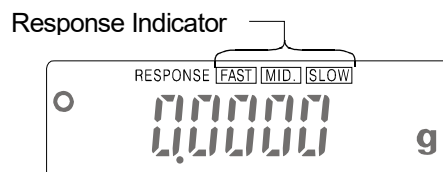

Note

- If the automatic response adjustment is too awkward, perform "Manual Response Adjustment".
- The response adjustment can be changed at "Condition (Cond)" of "Environment & Display (bRSFnC)" in the function table. Refer to "9. Function Table".



6.1. Automatic Response Adjustment

This way automatically updates the response adjustment by analyzing the influence of the environment on the weight data.

Operation

Step 1 Press and hold the **MODE** key until **RESPONSE** is displayed, and then release the key.

Step 2 The balance analyzes the influence and updates the response adjustment. If you want to cancel this update, press the **CAL** key.

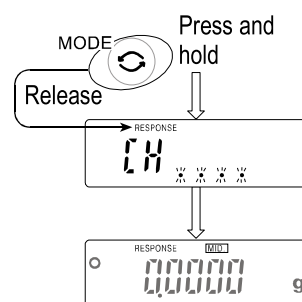

Caution

- Do not allow vibration or drafts to affect the balance.

Step 3 The balance returns to the weighing mode automatically and displays the updated response indicator.



6.2. Manual Response Adjustment

This way updates the response adjustment manually.

Operation

- Step 1 Press and hold the **MODE** key until **RESPONSE** is displayed. Press the **MODE** key immediately.
- Step 2 Select a stage of the response adjustment using the **MODE** key. Either **FAST** or **MID** or **SLOW** can be selected.
- Step 3 The balance automatically returns to the weighing mode after a few seconds of inactivity.

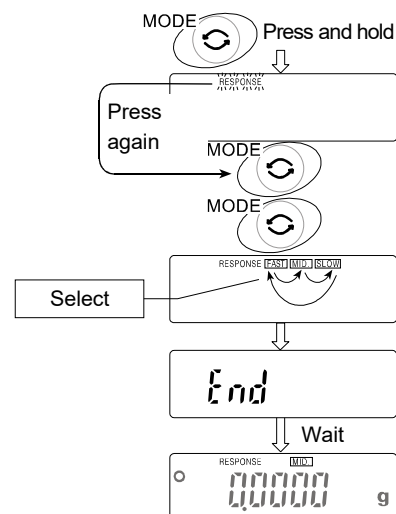

7. Calibration

The GR series has the following modes concerning calibration and calibration test.

- Automatic Self Calibration
- Calibration using the internal weight
- Calibration using an external weight
- Calibration test using the internal weight
- Calibration test using an external weight
- Correction of the internal weight value

Note

- Calibration is controlled by the parameters of "Permission or prohibition". Refer to section "8. Function Switch and Initialization".
- The weight which can be used for calibration is called "the calibration weight". The weight which can be used for calibration test is called "the target weight". The weight which you have is called "the external weight".

Caution

- This calibration achieves the adjustment for accurate weighing. It is necessary to perform calibration in the following case.
 - When the balance is installed for the first time.
 - When the balance has been moved.
 - When the ambient environment has changed.
 - For periodical calibration.
- Prevent vibration, drafts, and ambient temperature changes from the influence for the balance during calibration.
-  This indicator means "the balance is measuring calibration data". Do not allow vibration or drafts to affect the balance while this indicator is displayed.

- The data for GLP (Good Laboratory Practice) can be output using the RS-232C interface, when the "GLP output (*info*)" of "Data output (*data*)" is set to "1" or "2". Refer to section "9. Function Table".

Caution using an External Weight

- The accuracy of an external weight can influence the accuracy of weighing.

Product	Usable external weight	Adjustable range
GR-120	100 g, 50 g	+15.9 mg – -15.0 mg
GR-200	200 g, 100 g	
GR-300	200 g, 300 g	
GR-202	200 g, 100 g	



7.1. Automatic Self Calibration

This function automatically calibrates the balance, when the balance detects an ambient temperature change.



When the balance detects a change in ambient temperature, this indicator blinks and automatic self calibration is required. If the balance is not used for several minutes with this indicator blinking, the balance performs automatic self calibration. The environment will affect the time that the indicator blinks.



This display means "the balance is measuring calibration data". Do not allow vibration or drafts to affect the balance while this indicator is displayed.

Advice

You can use the balance while the indicator blinks. But, it is recommended that to maintain the best accuracy, stop using the balance and confirm that there is nothing on the pan when the indicator starts blinking.

Caution

- Do not place anything on the weighing pan during automatic calibration.

Control of Automatic Self Calibration

Automatic self calibration is controlled by a parameter in "Permission or prohibition". Refer to section "8. Function Switch and Initialization".



7.2. Calibration Using the Internal Weight

This function calibrates the balance using the internal weight.

- Step 1 Connect the AC adapter and warm up the balance for at least one hour with nothing on the weighing pan.
- Step 2 Press the **CAL** key to start calibration.
- Step 3 The balance displays **CAL in** and performs calibration. Prevent vibration and drafts from affecting the balance.
- Step 4 If the "GLP output (*inFd*)" of the "Function Table" is set to "1" or "2", "Calibration Report" is output from RS-232C interface.
- Step 5 The balance will automatically return to the weighing mode after calibration.
- Step 6 Test the accuracy of weighing using the calibration test function or by using a certified test weight.

Control of this Calibration

Calibration using the internal weight is controlled by a parameter in "Permission or prohibition". Refer to section "8. Function Switch and Initialization".



7.3. Calibration Test Using the Internal Weight

This function tests the balance accuracy using the internal weight.

Operation

- Step 1 Connect the AC adapter and warm up the balance for at least one hour with nothing on the pan.
- Step 2 Press and hold the **CAL** until displaying **[[[n]** and then release the key.
- Step 3 The balance measures the zero point.
Prevent vibration and drafts to affect the balance.
- Step 4 The measured zero point data is displayed.
- Step 5 Ready for the internal weight measurement.
- Step 6 The balance measures the internal weight.
Prevent vibration and drafts to affect the balance.
- Step 7 The internal weight data is displayed.
- Step 8 The balance informs you when the calibration test is finished. If the "GLP output ([n]F0)" of the "Function Table" is set to "1" or "2", "Calibration Test Report" is output by the RS-232C interface.
- Step 9 The balance will automatically return to the weighing mode after the calibration test is finished.

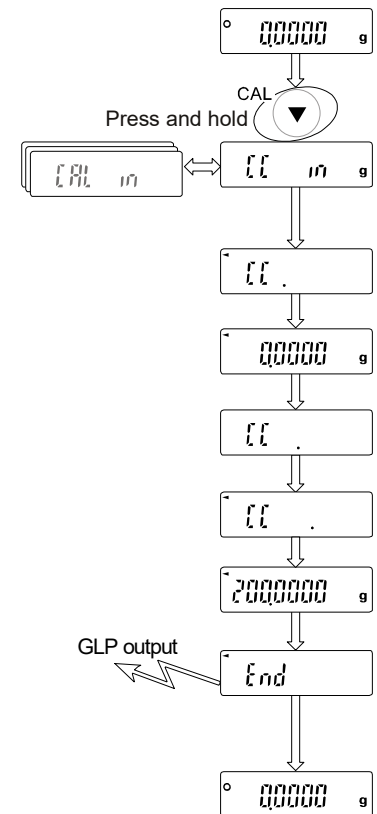



7.4. Calibration Using an External Weight

This function calibrates the balance using an external weight. The weight to be used for calibration is called "the calibration weight". The weight which you have is called "the external weight".

Operation

Step 1 Connect the AC adapter and warm up the balance for at least one hour with nothing on the pan.

Step 2 Press and hold the **CAL** key until displaying **CAL out** and then release the key

Step 3 The balance displays **CAL 0**.

- If you want to change the calibration weight value, proceed to step 4.
- If you use the stored calibration weight value in the balance, proceed to step 5.

Step 4 Press the **RANGE** key and adjust the calibration weight value using the following keys.

RE-ZERO key...The key to set the value of the digit selected.

RANGE key.....The key to select the digit to change value.

PRINT key.....The key to store a new weight value and return to step 3.

Even if the AC adapter is removed, the data is maintained in non-volatile memory.

CAL key.....The key to cancel this change and return to step 3.

Product	Usable weight	Adjustable range
GR-120	100 g, 50 g	+15.9 mg – -15.0 mg
GR-200	200 g, 100 g	
GR-300	200 g, 300 g	
GR-202	200 g, 100 g	

Note □ Digits cyclically change using the **RE-ZERO** key.
ex. 0 mg→+15 mg→-15 mg→0 mg

Step 5 Confirm that there is nothing on the pan and press the **PRINT** key. The balance measures the zeropoint. Prevent vibration and drafts from affecting the balance.

Step 6 Place the displayed calibration weight on the pan and press the **PRINT** key. The balance displays the measured calibration weight. Prevent vibration and drafts from affecting the balance.

Step 7 Remove the weight from the pan after the balance displays **End**.

Step 8 If the "GLP output (*Inf*)" of the "Function Table " is set to " *1* " or " *2* ", "Calibration Test Report" is output by the RS-232C interface.

Step 9 The balance will automatically return to the weighing mode after calibration.

Step 10 Test the accuracy of weighing using the calibration test function with a certified test weight.

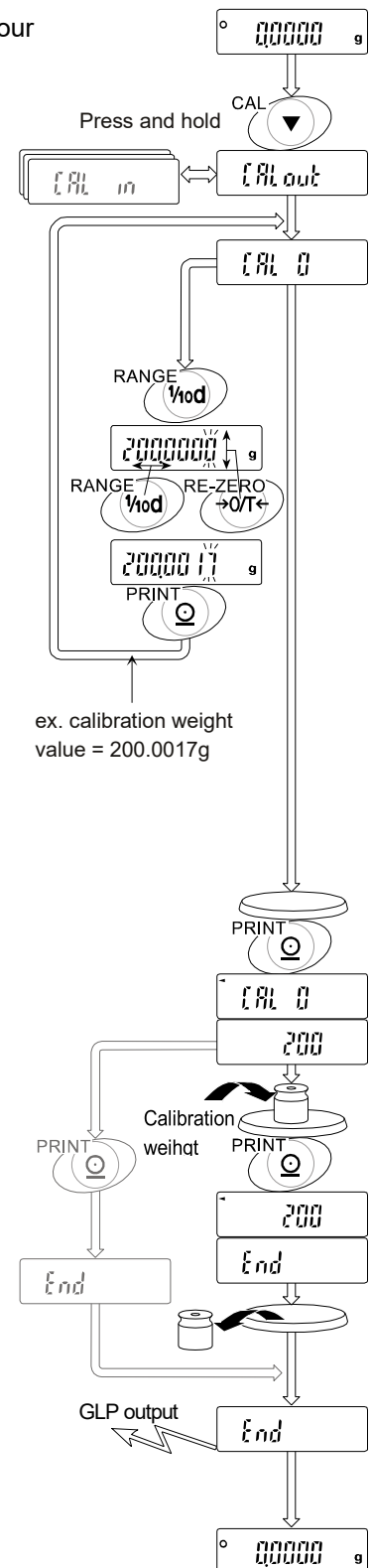

Control of this Calibration

Calibration using an external weight is controlled by a parameter in "Permission or prohibition". Refer to section "8. Function Switch and Initialization".



7.5. Calibration Test Using an External Weight

This function tests the balance for the accuracy using an external weight. A weight which is used for the calibration test is called "the target weight". The weight which you have is called "the external weight".

Operation

Step 1 Connect the AC adapter and warm up the balance for at least one hour with nothing on the pan.

Step 2 Press and hold the **CAL** key until displaying **CAL out** and then release the key.

Step 3 The balance displays **[[0]]**.

- If you want to change the target weight value, proceed to step 4.
- If you use the stored target weight value in the balance, proceed to step 5.

Step 4 Press the **RANGE** key and adjust the calibration weight value using the following keys.

RE-ZERO key...The key to set the value of the digit selected.

RANGE key.....The key to select the digit to change value.

PRINT key.....The key to store a new weight value and return to step 3.

Even if the AC adapter is removed, the data is maintained in non-volatile memory.

CAL key.....The key to cancel this change and return to step 3.

Product	Usable weight	Adjustable range
GR-120	100 g, 50 g	+15.9 mg – -15.0 mg
GR-200	200 g, 100 g	
GR-300	200 g, 300 g	
GR-202	200 g, 100 g	

Note □ Digits cyclically change using the RE-ZERO key.
ex. 0 mg→+15 mg→-15 mg→0 mg

Step 5 Confirm that there is nothing on the pan and press the **PRINT** key. The balance measures the zeropoint and displays it. Prevent vibration and drafts from affecting the balance.

Step 6 Place the displayed target weight on the pan and press the **PRINT** key. The balance displays the measured target weight and displays it. Prevent vibration and drafts from affecting the balance.

Step 7 Remove the weight from the pan after the balance displays **End**.

Step 8 If the "GLP output (*INF0*)" of the "Function Table " is set to "1" or "2", "Calibration Test Report" is output by the RS-232C interface.

Step 9 The balance will automatically return to the weighing mode after calibration.

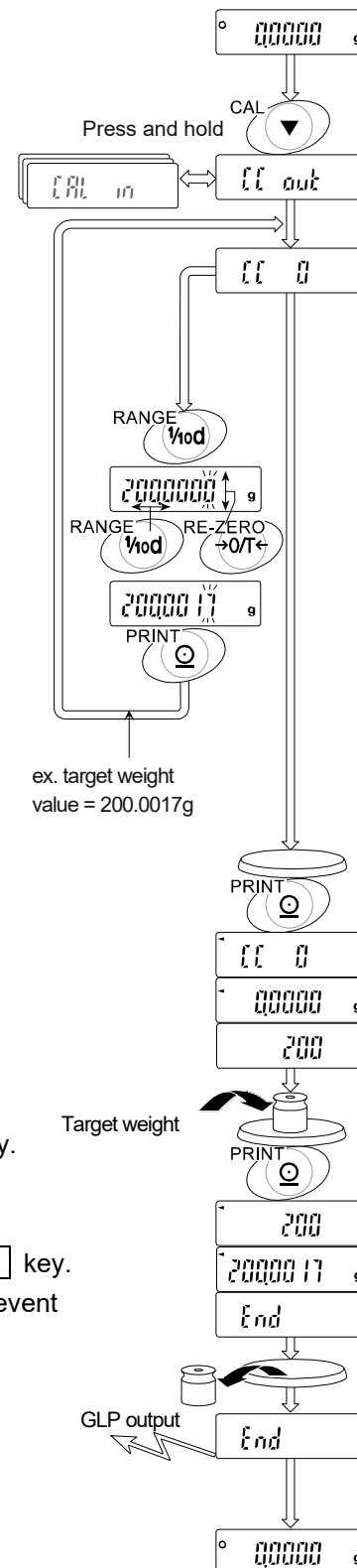



7.6. Correcting the Internal Weight Value

The balance can correct the internal mass value within the range shown below. This function corrects the internal mass value to conform to an external weight. The corrected mass value is maintained in non-volatile memory even if the AC adapter is removed.

Model	Target	Range
GR-120	100.0000 g	±1.5 mg
GR-200	200.0000 g	
GR-300		
GR-202		

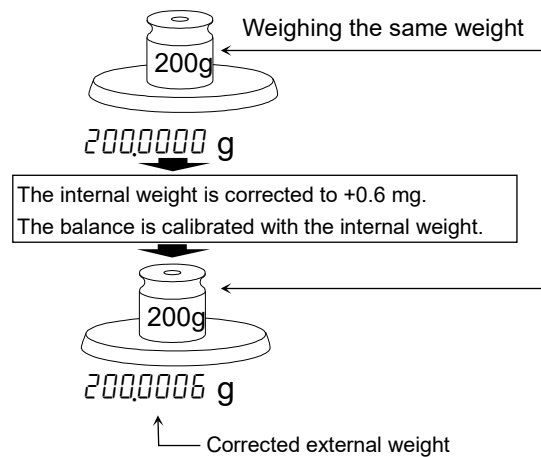

Operation

- Step 1 Turn off the display using the **ON:OFF** key.
- Step 2 Press the **ON:OFF** key while the **RANGE** key and **PRINT** key are pressed and held. Then the balance displays **P5**.
- Step 3 Press the **PRINT** key. Then the balance displays the switches.
- Step 4 Set the following switches to "1".
 - RANGE** keyThe key to select the switch to change the setting.
 - RE-ZERO** keyThe key to select the setting of the switch.

$\bar{R} - 1 \times \times \times 1$

 - ← Switch for the function
 - ← Switch for the internal weight
- Step 5 Press the **PRINT** key to store the new setting. The balance will return to the weighing mode.
- Step 6 Press and hold the **RANGE** key to enter the function table and release the key when **bR5FnC** is displayed.
- Step 7 Press the **RANGE** key several times to display **LS in**.
- Step 8 Press the **PRINT** key to enter into the procedure for correcting the internal weight value.
- Step 8 Correct the internal weight value using the following keys.
 - RE-ZERO** keyThe value is selected. (+1.5 mg – -1.5 mg)
 - PRINT** keyThe new value is stored and **id** is displayed
 - CAL** keyThis correction is canceled and **id** is displayed.
- Step 9 Press the **CAL** key. The balance will return to the weighing mode.
- Step 10 Press the **CAL** key to calibrate the balance.

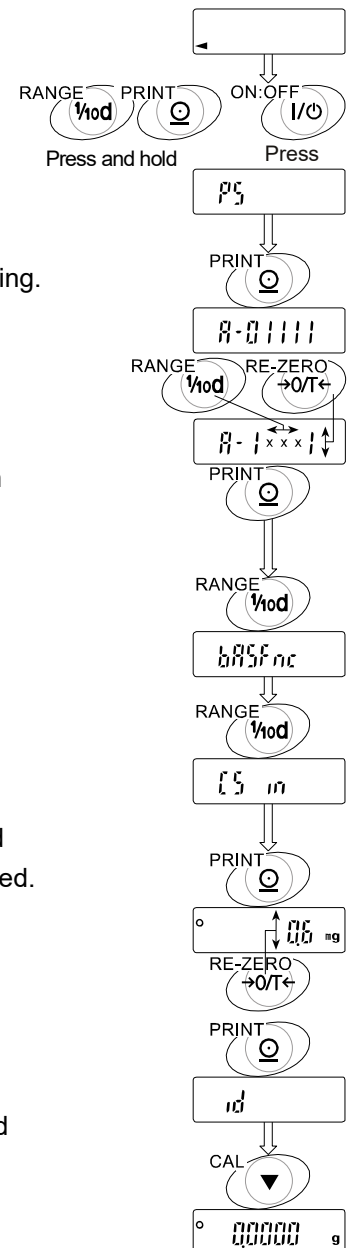

Control of the Correction

Correction of the internal weight value is controlled by the parameters in "Permission or prohibition". Refer to section "8. Function Switch and Initialization"



8. Function Switch and Initialization



8.1. Permission or Prohibition

The balance stores parameters that must not be changed carelessly (ex. Calibration data for precision weighing, Data for adapting to environment, Control data for RS-232C interface, etc.). There are five switches for the purpose of preserving these parameters. Each switch can select either "permission" or "prohibition". The "prohibition" protects careless operation.

Switches

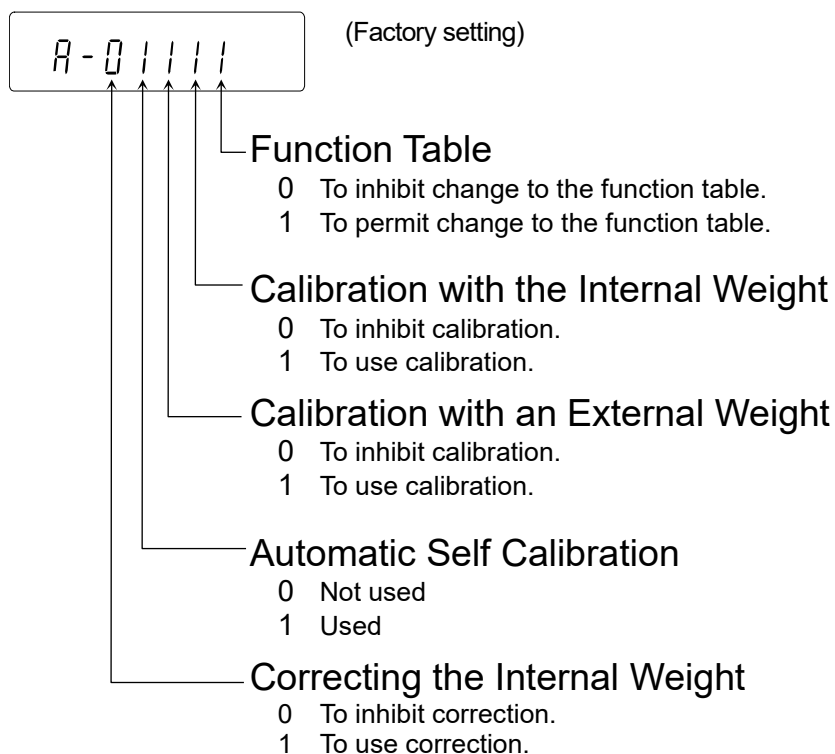

Operation

- Step 1 Turn off the display using the **ON:OFF** key.
- Step 2 Press the **ON:OFF** key while the **RANGE** key and **PRINT** key are pressed and held. Then the balance displays **P5**.
- Step 3 Press the **PRINT** key. Then the balance displays the switch settings.
- Step 4 Set the switches using the following keys.
- RANGE** key The key to select the switch to change the setting.
 - RE-ZERO** key The key to change the setting of the switch.
 - PRINT** key The key to store the new setting.
 - CAL** key The key to cancel this operation.



8.2. Initializing the Balance

This function returns the following parameters to factory settings.

- Calibration data.
- Function table.
- The 100% weight
- The data that is stored in the balance using data memory function.
- External calibration weight and target weight.
- Switch settings for "Permission or prohibition".

Operation

Step 1 Turn off the display.

Step 2 Press the **ON:OFF** key while the **RANGE** key and **PRINT** key are pressed and held. Then the balance display **P5**.

Step 3 Press the **RANGE** key to display **ELr**.

Step 4 Press the **PRINT** key. (If you want to cancel this operation, press the **CAL** key)

Step 5 Press the **RE-ZERO** key.

Step 6 Press the **PRINT** key to initialize the balance. The balance will automatically return to weighing mode.

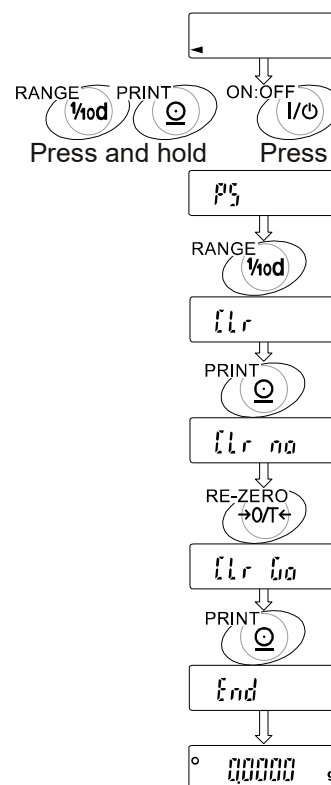



9. Function Table

The operation of the "Function Table" is to read or rewrite the parameters that are stored in the balance. These parameters are stored until the next change, even if the AC adapter is removed.

The function table menu consists of two layers. The first layer is the "Class" and second layer is the "Item". Each Item stores a parameter. The effective parameter is the last parameter that is displayed in the sequence. New parameters operate upon the balance after pressing the **PRINT** key.

Structure and Sequence of the Function Table

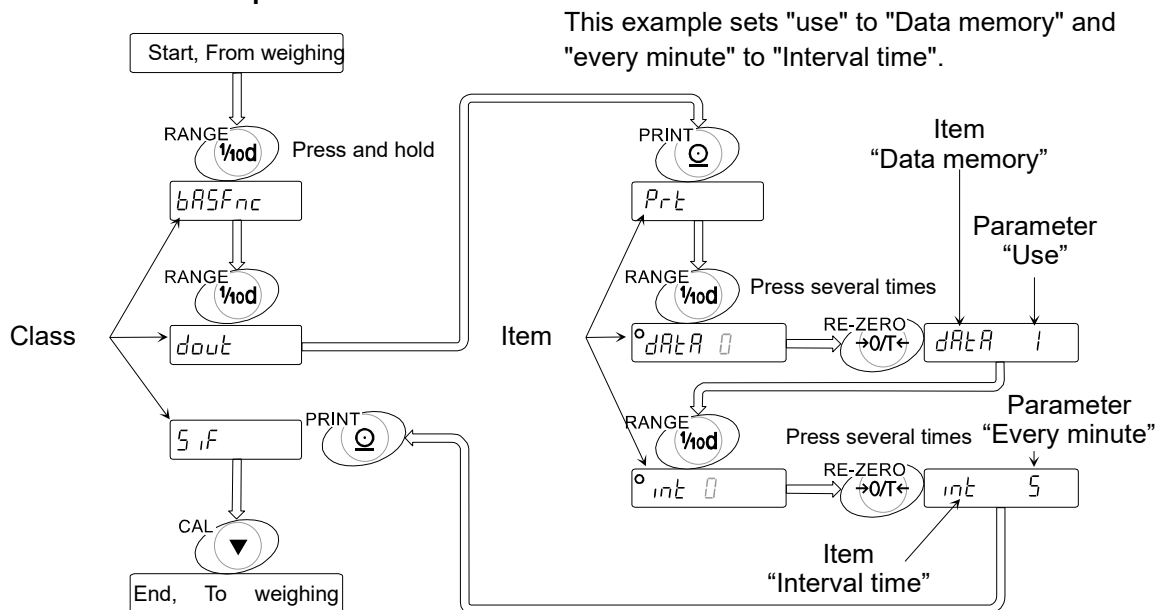

Caution

- The balance may not work effectively when a combination of parameters and environment are not proper. Confirm the parameter before changing it.

Control of this Function Table

- The function table is controlled by a parameter in "Permission or prohibition". Refer to section "8. Function Switch and Initialization".



9.1. Display and Keys of the Function Table



The "0" symbol is displayed at a selected parameter.



When the key is pressed and held in weighing mode, the balance enters the "function table mode". The key to change the class or item in the function table mode.

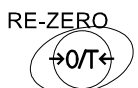

The key to select the parameter, when the balance displays an item.

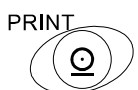

The key to move to an item from the class, when the balance displays a class. The key to store new parameters and display the next class, when the balance displays an item.



The key to cancel new parameters and display the next class, when the balance displays an item. The key to exit the function table mode, when the balance displays a class.



9.2. Details of the Function Table

Class	Item	Parameter	Summaries		
<i>bR5Fnc</i> Environment, Display	<i>Cond</i> Condition	0	Fast response, Sensitive value	Common data of "Response adjustment".	
		1	↕		
	2	Slow response and stable value			
	<i>St-b</i> Stability band width	0	Stable when within ±1 digit	↕	The stability indicator lights when the display fluctuation is within the range per second.
		1	Stable when within ±3 digit		
	<i>trc</i> Zero tracking	0		OFF	The function to keep zero display by tracking zero-drift.
		1	ON		
<i>SPd</i> Display update rate	0	Normal, 5 times/second	The period to refresh the display.		
	1	Fast, 10 times/second			
<i>Pnt</i> Decimal point	0	Point (.)	The form of decimal point.		
	1	Comma (,)			
<i>P-on</i> Automatic start	0	OFF	Connecting adaptor, the display turns on without key operation.		
	1	ON			
<i>dout</i> Data output	<i>Prt</i> Data output mode	0	Key mode	Data is output or stored with PRINT key and stability indicator.	
		1	Auto-print mode A (Standard value is zero)	Data is output or stored when the display value is stable and meets the conditions of <i>RP-P</i> , <i>RP-b</i> and standard value.	
		2	Auto-print mode B (Standard value is last stable value)	In case of <i>dRtR</i> 0, data is output continuously. In case of <i>dRtR</i> 1, data memory function is used.	
		3	Stream mode / Interval memory mode		
	<i>RP-P</i> Auto-print polarity for mode A or B	0	Plus polarity	Display value ≥ Standard value	
		1	Minus polarity	Standard value > Display value	
		2	Both polarities (Absolute value)	Display value ≥ Standard value or Standard value > Display value	
	<i>RP-b</i> Auto-print difference for mode A or B	0	10 digit	Difference between standard value and display value	
		1	100 digit		
		2	1000 digit		
	<i>dRtR</i> Data memory function	0	Not used	Relation: <i>Prt</i> , <i>int</i> , <i>d-no</i>	
		1	Use		
	<i>int</i> Interval time for Data memory function	0	Every Measurement	Interval time is selected on <i>Prt</i> 3, <i>dRtR</i> 1	
1		Every 2 seconds			
2		Every 5 seconds			
3		Every 10 seconds			
4		Every 30 seconds			
5		Every 1 minute			
6		Every 2 minutes			
7		Every 5 minutes			
8	Every 10 minutes				
<i>d-no</i> Data number output	0	No output	Refer to section "11. Data Memory Function".		
	1	Output			
<i>PUSE</i> Data pause	0	No pause	Selection of output interval.		
	1	Pause (1.6 seconds)			

Note: "Digit" is the unit of readability.

▪ Factory setting.

Class	Item	Parameter	Summaries	
<i>dout</i> Data output	<i>AE-F</i> Auto feed	0	Not used	Selection of paper feed after printing.
		1	Use	
	<i>info</i> GLP output	0	No output	The GLP data output.
		1	AD-8121 format	
		2	Data format	
	<i>Ar-d</i> Zero after output	0	Not used	Function to automatically re-zero after data output.
1		Use		
<i>SIF</i> Serial Interface	<i>bPS</i> baud rate	0	600 bps	
		1	1200 bps	
		2	2400 bps	
		3	4800 bps	
		4	9600 bps	
	<i>btPr</i> Length, Parity bit	0	7 bits, even parity check	
		1	7 bits, odd parity check	
		2	8 bits, no parity check	
	<i>CrLF</i> Terminator	0	CR LF	CR: ASCII code 0Dh LF: ASCII code 0Ah
		1	CR	
	<i>tYPE</i> Data format	0	A&D standard format	Refer "9.5. Explanation of Item "Data format"".
		1	DP format	
		2	KF format	
		3	MT format	
<i>t-UP</i> Receive time	0	No limit	Waiting time during a command.	
	1	For one second		
<i>ErCd</i> <AK> and error code	0	No output	AK: ASCII code 06h	
	1	Output		
<i>cts</i> CTS control	0	Not used	Keep the RTS line (active) high while the computer receives data. CTS low will be set if it is busy.	
	1	Using CTS and RTS		
<i>dS Fnc</i> Density function	<i>Ldin</i> Liquid density input	0	Water temperature	Available only when density mode is selected.
		1	Liquid density	
<i>Unit</i> Unit	Refer to section "4. Weighing Units"			
<i>CS in</i> Correction of internal weight	Refer to section "7. Calibration"			
<i>id</i> ID number	Refer to section "10. ID Number and GLP Report "			

- Factory setting.

Caution

- When the baud rate is set to 2400bps or less, the output rate is slower than the display update rate and the balance may not transmit the data completely (and transmits it intermittently).



9.3. Explanation of Item "Environment, Display"

Condition (Cond)

$\text{Cond } 0$

This parameter is for sensitive response to the fluctuation of a weight value.



Use for target weighing of powder, weighing of a very light sample or weighing requiring quick response.

$\text{Cond } 2$

This parameter is for stable weighing with slow response.

Use to prevent a weight value from drifting depended on the balance location.

Stability band width (St-b)

This item controls the width to regard a weight value as a stable value.

When the fluctuation per second is less than this parameter, the balance displays the stability indicator and outputs or stores the data. This parameter influences the "Auto-print mode"

$\text{St-b } 0$

This parameter is for sensitive response of the stability indicator.



Use for exact weighing.

$\text{St-b } 2$

This parameter ignores slight fluctuation of a weight value.

Use to prevent the weight value from drifting.

Zero tracking (Trc)

This function traces zero point drift and keeps a zero display automatically, when the weighing value drifts due to changes in the environment.

$\text{Trc } 0$

The tracking function is not being used.



Use for weighing of a very light sample.

$\text{Trc } 1$

The tracking function is used.

Display update rate (SPd)

The display update rate influences "Baud rate", "Data pause" and "Stream mode".

Decimal point (Pnt)

The decimal point form can be selected.

Automatic start (P-on)

When the AC adapter is connected, weighing is automatically started without key operation. Use for a built-in balance in a system. Warm-up for at least one hour is necessary for accurate weighing.



9.4. Explanation of Item "Data output mode"

The **PRINT** key can be used at any time for transmitting data.

Key Mode

When you press the **PRINT** key and the display value is stable, the balance outputs the weighing data and the display blinks one time.

Required setting *dout* *Prt 0* Print key mode

Auto-Print Mode A

When the display value is stable and meets the conditions of "Auto-print polarity", "Auto-print band" and standard value (of zero point), the balance outputs the weighing data. If you press the **PRINT** key, the balance outputs the data and the display blinks one time.

Required setting *dout* *Prt 1* Auto-print mode A
 dout *RP-P* Auto-print polarity
 dout *RP-b* Auto-print band

Example "The *Rr-d 1* (zero after output) is set. A sample is placed and removed for weighing each time."

Auto-Print Mode B

When the display value is stable and meets the conditions of "Auto-print polarity", "Auto-print band" and standard value (of last stable value), the balance outputs the weighing data. If you press the **PRINT** key, the balance outputs the data and the display blinks one time.

Required setting *dout* *Prt 2* Auto-print mode B
 dout *RP-P* Auto-print polarity
 dout *RP-b* Auto-print band

Example "Transmitting the data of each operation."

Stream Mode

The balance outputs the weighing data continuously.

Required setting *dout* *Prt 3* Stream mode
 dout *dMEm 0* Data memory function is not used.
 bRSFnc *SPd* Display update rate
 SrF *bPS* Baud rate

Example "Monitoring data on a computer"

Caution

- When the baud rate is set to 2400bps or less, the display update rate is faster than the output rate and the balance may not transmit the data completely (and transmits it intermittently).

Interval Memory Mode

This is the data memory function mode. Weighing data is periodically stored in the balance. The interval memory mode can not be used, while stream mode is used.

Required setting *dout* *Prt 3* Interval memory mode
 dout *dMEm 1* Data memory function is used.
 dout *int* Interval time

Example "Periodical weighing without computer command and outputting all of the data to a computer at one time"



9.5. Explanation of Item "Data format"

A&D standard format

5 IF TYPE 0

This format is used when the peripheral equipment is capable of receiving A&D format. If an AD-8121 is used, set the printer to mode 1 or 2.

- This format consists of fifteen characters (excluding the terminator).
- A header of two characters indicates the status of the stability.
- The plus sign is placed before the data, when the data is zero or positive.
- The weight data uses leading zeros.
- The unit has three characters.

S	T	,	+	0	0	0	.	1	2	7	8			g	C _R	L _F
---	---	---	---	---	---	---	---	---	---	---	---	--	--	---	----------------	----------------

Header
Data
Unit
Terminator

S	T	Stable header
---	---	---------------

Q	T	Stable header for counting mode
---	---	---------------------------------

U	S	Unstable header
---	---	-----------------

O	L	Overload header
---	---	-----------------

D.P. (Dump print) format

5 IF TYPE 1

This format is used when the peripheral equipment can not process the A&D format. If an AD-8121 is used, set the printer to mode 3.

- This format consists of sixteen characters (excluding the terminator).
- A header of two characters indicates the status of the stability without overload.
- The polarity sign is placed before data, if not zero or overloaded.
- The weight data has spaces in place of the leading zeros.
- The unit has three characters.

W	T					+	0	.	1	2	7	8			g	C _R	L _F
---	---	--	--	--	--	---	---	---	---	---	---	---	--	--	---	----------------	----------------

Header
Data
Unit
Terminator

W	T	Stable header
---	---	---------------

Q	T	Stable header for counting mode
---	---	---------------------------------

U	S	Unstable header
---	---	-----------------

KF format

5 IF TYPE 2

This is the Karl-Fischer moisture meter format, and is used when the peripheral equipment can only communicate using this format.

- This format consists of fourteen characters (excluding the terminator).
- This format has no header characters.
- The polarity sign is first, if not zero or overloaded.
- The weight data uses spaces in place of leading zeros.
- This format outputs the unit "g" only for a stable value.

+				0	.	1	2	7	8		g			C _R	L _F
---	--	--	--	---	---	---	---	---	---	--	---	--	--	----------------	----------------

Data
Unit
Terminator

	g			Stable value
--	---	--	--	--------------

				Unstable value
--	--	--	--	----------------

MT format

SIF TYPE 3

- This format has a two character header.
- The polarity sign is used only for negative data.
- The weight data uses spaces in place of the leading zeros.
- The character length of this format changes dependent upon the unit.

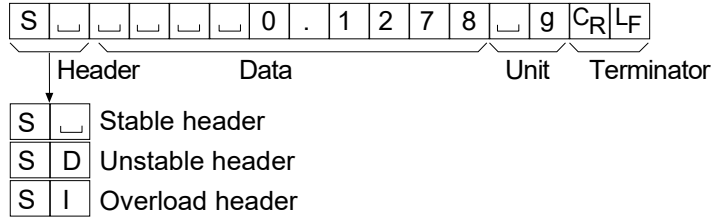

NU (numerical) format

SIF TYPE 4

- This format has only numerical data.
- This format consists of nine characters (excluding the terminator).
- The polarity sign is first.
- The weight data uses leading zeros.

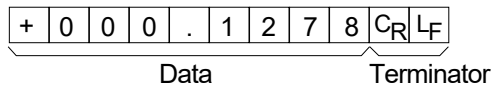

Data number format

dout d-no 1

This data number format is output just before data is transmitted to the RS-232C interface.

- This format consists of six characters (excluding the terminator).

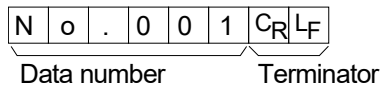



9.6. Examples of Data Format

Stable

0.1278 g

A&D	S	T	,	+	0	0	0	.	1	2	7	8	␣	␣	g	C _R	L _F	
DP	W	T	␣	␣	␣	␣	␣	+	0	.	1	2	7	8	␣	␣	g	C _R L _F
KF	+	␣	␣	␣	0	.	1	2	7	8	␣	g	␣	␣	C _R	L _F		
MT	S	␣	␣	␣	␣	␣	0	.	1	2	7	8	␣	g	C _R	L _F		
NU	+	0	0	0	.	1	2	7	8	C _R	L _F							

Unstable

-18.3690 g

A&D	U	S	,	-	0	1	8	.	3	6	9	0	␣	␣	g	C _R	L _F
DP	U	S	␣	␣	␣	-	1	8	.	3	6	9	0	␣	␣	g	C _R L _F
KF	-	␣	␣	1	8	.	3	6	9	0	␣	␣	␣	␣	C _R	L _F	
MT	S	D	␣	␣	-	1	8	.	3	6	9	0	␣	g	C _R	L _F	
NU	-	0	1	8	.	3	6	9	0	C _R	L _F						

Overload

(Positive error)

E g

A&D	O	L	,	+	9	9	9	9	9	9	9	E	+	1	9	C _R	L _F
DP	␣	␣	␣	␣	␣	␣	␣	␣	E	␣	␣	␣	␣	␣	␣	C _R	L _F
KF	␣	␣	␣	␣	␣	␣	H	␣	␣	␣	␣	␣	␣	␣	C _R	L _F	
MT	S	I	+	C _R	L _F												
NU	+	9	9	9	9	9	9	9	9	9	C _R	L _F					

Overload

(Negative error)

-E g

A&D	O	L	,	-	9	9	9	9	9	9	E	+	1	9	C _R	L _F	
DP	␣	␣	␣	␣	␣	␣	␣	-	E	␣	␣	␣	␣	␣	␣	C _R	L _F
KF	␣	␣	␣	␣	␣	␣	L	␣	␣	␣	␣	␣	␣	␣	C _R	L _F	
MT	S	I	-	C _R	L _F												
NU	-	9	9	9	9	9	9	9	9	9	C _R	L _F					

Data number

N	o	.	0	0	1	C _R	L _F										
S	T	,	+	0	0	0	.	1	2	7	8	␣	␣	g	C _R	L _F	

␣ Space, ASCII 20h

C_R Carriage Return, ASCII 0Dh

L_F Line Feed, ASCII 0Ah

Units	Symbol	A&D	D.P.	KF	MT
Gram mode	g	□ □ g	□ □ g	□ g □ □	□ g
Milligram mode	mg	□ m g	□ m g	□ m g □	□ m g
Counting mode	pcs	□ P C	□ P C	□ p c s	□ P C S
Percent mode	%	□ □ %	□ □ %	□ % □ □	□ %
Ounce (Avoir)	oz	□ o z	□ o z	□ o z □	□ o z
Troy Ounce	ozt	o z t	o z t	□ o z t	□ o z t
Metric Carat	ct	□ c t	□ c t	□ c t □	□ c t
Momme	mom	m o m	m o m	□ m o m	□ m o
Pennyweight	dwt	d w t	d w t	□ d w t	□ d w t
Grain	GN	□ G N	□ G N	□ g r □	□ G N
Tael (HK general, Sing.)	tl	□ T L	□ T L	□ t l s	□ t l
Tael (HK, jewelry)	tl	□ T L	□ T L	□ t l h	□ t l
Tael (China)	tl	□ T L	□ T L	□ t l t	□ t l
Tael (Taiwan)	tl	□ T L	□ T L	□ t l c	□ t l
Tola (India)	t	□ □ t	□ □ t	□ t o l	□ t
Messghal	m	m e s	m e s	□ M S □	□ m
Density		□ D S	□ D S	□ D S □	□ D S

□ Space, ASCII 20h



10. ID Number and GLP Report



10.1. Main Objectives

- The ID number is used to identify the balance when Good Laboratory Practice (GLP) is used.
- The ID number is output on the "Calibration Report", "Calibration Test Report" and "Title block".
- The GLP output format is selected at the "GLP output (*inF0*)" of the "Function Table".
- The balance can output the following reports for GLP.
 - "Calibration Report" of the calibration using the internal weight.
 - "Calibration Report" of the calibration using an external weight.
 - "Calibration Test Report" of the calibration using the internal weight.
 - "Calibration Test Report" of the calibration using an external weight.
 - "Title block" and "End block" for weighing data.



10.2. Setting the ID Number

Step 1 Press and hold the **RANGE** key to display `bA5FnC`.

Step 2 Press the **RANGE** key several times to display `id`.

Step 3 Press the **PRINT** key. You can set the ID number using the following keys.

RANGE key The key to increment the digit.

RE-ZERO key The key to select the character of the digit. Refer to the following table for the "Display Character Set".

CAL key The key to cancel the new ID number and display `bA5FnC`.

PRINT key The key to store the new ID number and display `bA5FnC`.

Display Character Set

0	1	2	3	4	5	6	7	8	9	-	_	A	B	C	D	E	F	G	H	I	J	K	L	M	N	O	P	Q	R	S	T	U	V	W	X	Y	Z
0	1	2	3	4	5	6	7	8	9	-	_	A	B	C	d	E	F	G	H	I	J	K	L	ñ	n	o	P	q	r	S	t	U	ü	ü	ü	ü	ü

_ Space

Step 4 With `bA5FnC` displayed, press the **CAL** key to return to the weighing mode.



10.3.GLP Output

Set the following parameters to output the report.

- If the report is printed, set the "GLP output (*info*)" to "1". The AD-8121B printer is used in this explanation. Refer to "15.2. Connection to AD-8121B Printer". The AD-8121B uses MODE 3.
- The report is output to the RS-232C interface of a computer, set the "GLP output (*info*)" to "2".

Calibration report using the internal weight

Key operation

- Step 1 Press the **CAL** key to display **CAL in**. The balance calibrates automatically.
- Step 2 If the calibration report is output, **GLP** is displayed and the GLP data is output.
- Step 3 The balance returns to the normal weighing mode automatically.

AD-8121B format

info 1

```

                A & D
MODEL          GR-200
S/N           12345678
ID            ABCDEFGH
DATE          2005/01/01
TIME          09:54:28
CALIBRATED(INT.)
SIGNATURE
-----

```

← Manufacturer →
 ← Model →
 ← Serial number →
 ← ID →
 ← Date →
 ← Time →
 ← Calibration type →
 ← Signature →

Data format

info 2

```

                A & D <TERM>
MODEL          GR-200 <TERM>
S/N           12345678 <TERM>
ID            ABCDEFGH <TERM>
DATE          <TERM>
TIME          <TERM>
CALIBRATED (INT.) <TERM>
SIGNATURE <TERM>
----- <TERM>

```

- ␣ : Space, ASCII 20h
- <TERM> : Terminator, CR LF or CR
- CR : Carriage return, ASCII 0Dh
- LF : Line feed, ASCII 0Ah

Example of GR-200

Calibration test report using the internal weight

Key operation

- Step 1 Press and hold the **CAL** key until displaying **[[[in]**. Release the key.
- Step 2 The balance displays **[[[]** and performs the calibration test automatically.
- Step 3 The zero point is measured and this value is displayed.
- Step 4 The internal weight is measured and this value is displayed.
- Step 5 If the calibration test report is output, **[GLP]** is displayed and the GLP data is output.
- Step 6 The balance returns to the weighing mode automatically.

Command operation

- Step 1 Transmit the TST command to the balance.
- Step 2 The balance performs the calibration test automatically.
- Step 3 If the calibration test report is output, the GLP data is output.
- Step 4 The balance returns to the weighing mode automatically.

AD-8121B format

info 1

```

      A & D
MODEL  GR-200
S/N    12345678
ID     ABCDEFGH
DATE   2005/01/01
TIME   09:54:28
CAL.TEST(INT.)
ACTUAL
      0.0000 g
      +200.0002 g
TARGET
      +200.0000 g
SIGNATURE
-----

```

Data format

info 2

```

.....A&D<TERM>
MODEL.....GR-200<TERM>
S/N.....12345678<TERM>
ID.....ABCDEFGH<TERM>
DATE<TERM>
<TERM>
TIME<TERM>
<TERM>
CAL.TEST(INT.)<TERM>
ACTUAL<TERM>
.....0.0000...g<TERM>
....+200.0002...g<TERM>
TARGET<TERM>
....+200.0000...g<TERM>
SIGNATURE<TERM>
<TERM>
<TERM>
-----<TERM>
<TERM>
<TERM>

```

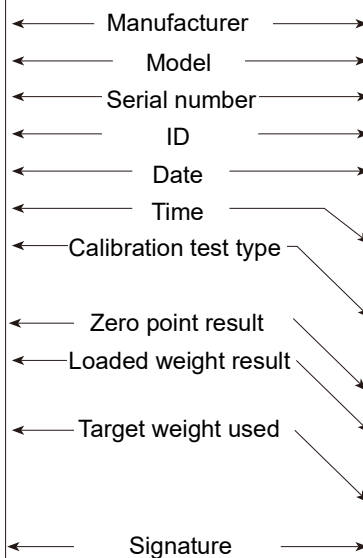

- : Space, ASCII 20h
- <TERM> : Terminator, CR LF or CR
- CR : Carriage return, ASCII 0Dh
- LF : Line feed, ASCII 0Ah

Example of GR-200

Calibration Report using an external weight

Key operation

- Step 1 Press and hold the **CAL** key until displaying **[CALout]**. Release the key.
- Step 2 The balance displays **[CAL 0]**.
 If you want to change the calibration weight value, proceed to step 3.
 If you use the stored calibration weight value in the balance, proceed to step 4.
- Step 3 Press the RANGE key and adjust calibration weight using the following keys.
- RANGE** key The key to select the digit to change value.
 - RE-ZERO** key The key to set the value of the digit selected.
 - PRINT** key The key to store a new weight value and return to step 2.
 - CAL** key The key to cancel this change and return to step 2.
- Step 4 Press the **PRINT** key. The zero point is measured and this value is displayed.
- Step 5 Place the calibration weight on the pan and press the **PRINT** key. The weight is measured and this value is displayed.
- Step 6 Remove the weight after **[End]** is displayed.
- Step 7 If the calibration report is output, **[GLP]** is displayed and the GLP data is output.
- Step 8 The balance returns to the weighing mode automatically.

AD-8121B format

info 1

```

      A & D
MODEL   GR-200
S/N     12345678
ID      ABCDEFGH
DATE    2005/01/01
TIME    09:54:28
CALIBRATED(EXT.)
CAL.WEIGHT
      +200.0000 g
SIGNATURE
-----
    
```

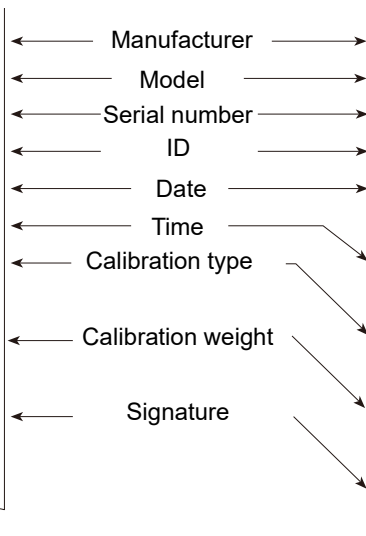

Data format

info 2

```

.....A.&D<TERM>
MODEL.....GR-200<TERM>
S/N.....12345678<TERM>
ID.....ABCDEFGH<TERM>
DATE<TERM>
<TERM>
TIME<TERM>
<TERM>
CALIBRATED(EXT.)<TERM>
CAL.WEIGHT<TERM>
....+200.0000..g<TERM>
SIGNATURE<TERM>
<TERM>
-----<TERM>
<TERM>
<TERM>
    
```

- ␣ : Space, ASCII 20h
- <TERM> : Terminator, CR LF or CR
- CR : Carriage return, ASCII 0Dh
- LF : Line feed, ASCII 0Ah

Example of GR-200

Calibration Test Report using an external weight

Key operation

- Step 1 Press and hold the **CAL** key until displaying **[[out]]**. Release the key.
- Step 2 The balance displays **[[0]]**.
 If you want to change the target weight value, proceed to step 3.
 If you use the stored target weight value in the balance, proceed to step 4.
- Step 3 Press the **RANGE** key and adjust target weight using the following keys.
RANGE key The key to select the digit to change value.
RE-ZERO key The key to set the value of the digit selected.
PRINT key The key to store a new weight value and return to step 2.
CAL key The key to cancel this change and return to step 2.
- Step 4 Press the **PRINT** key. The zero point is measured and this value is displayed.
- Step 5 Place the calibration weight on the pan and press the **PRINT** key. The weight is measured and this value is displayed.
- Step 6 Remove the weight after **End** is displayed.
- Step 7 If the calibration test report is output, **GLP** is displayed and the GLP data is output.
- Step 8 The balance returns to the weighing mode automatically.

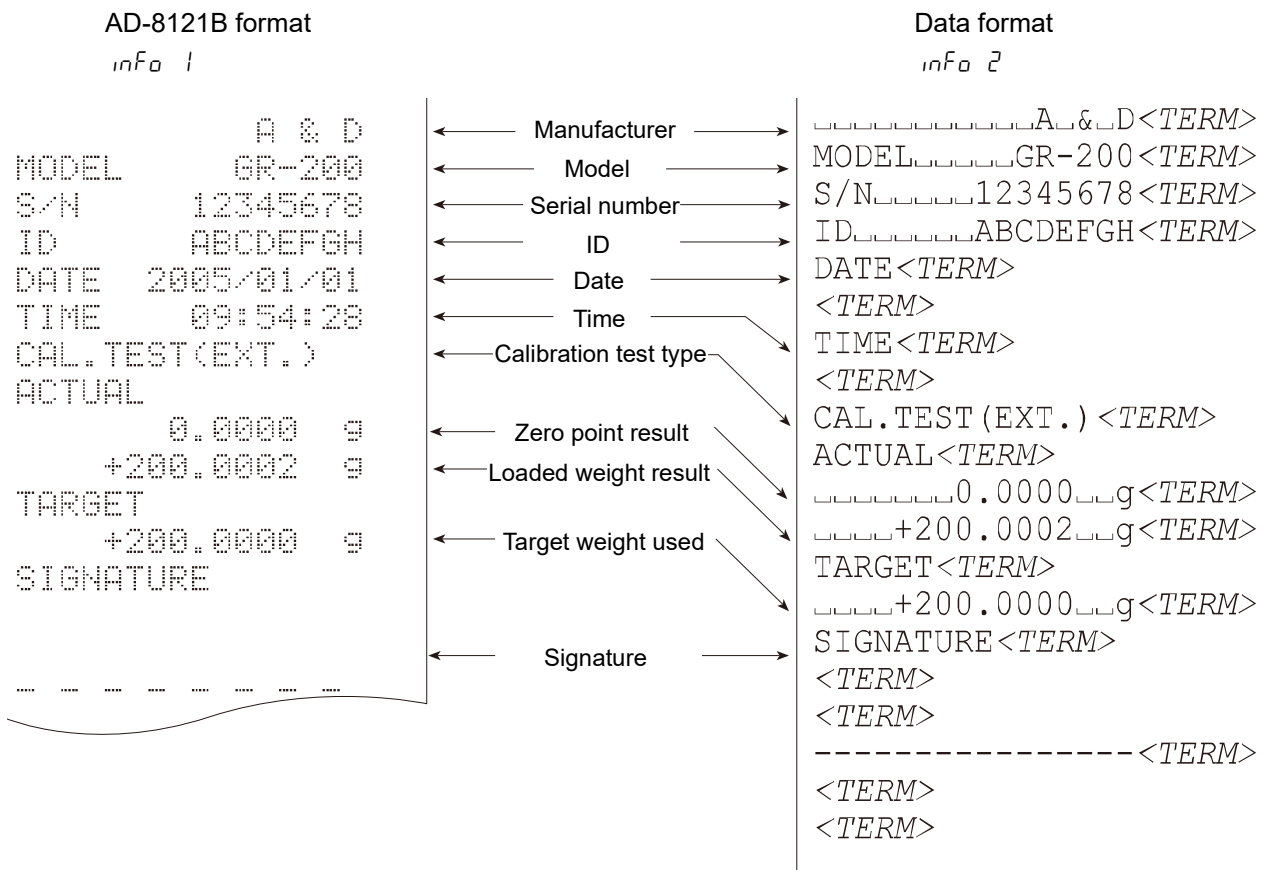

- : Space, ASCII 20h
- <TERM> : Terminator, CR LF or CR
- CR : Carriage return, ASCII 0Dh
- LF : Line feed, ASCII 0Ah

Example of GR-200

Title Block and End Block

Use

When a weight value is recorded as the GLP data, the GLP report can put the weighing value between "Title block" and "End block".

Caution

- If data memory function is used, the "Title block" and "End block" cannot be output. Use MODE 3 of the AD-8121.

Key operation

Step 1 Press and hold the **PRINT** key to display **Start** and release the key. The "Title block" is output.

Step 2 The weighing data is output.

Step 3 Press and hold the **PRINT** key to display **RecEnd** and release the key. The "End block" is output. The "Title block" and "End block" are output alternately by pressing the **PRINT** key.

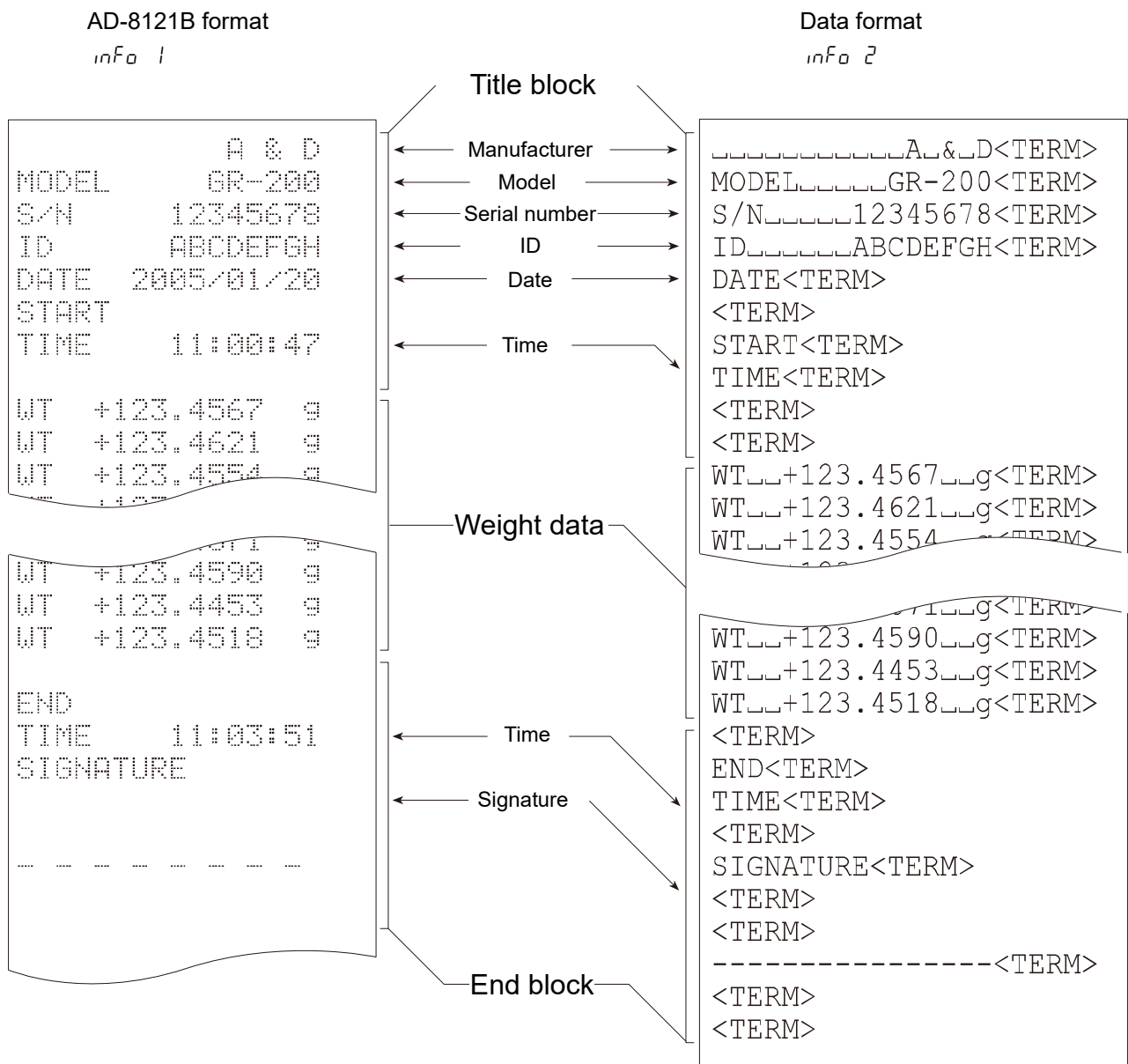

- : Space, ASCII 20h
- <TERM> : Terminator, CR LF or CR
- CR : Carriage return, ASCII 0Dh
- LF : Line feed, ASCII 0Ah



11. Data Memory Function



11.1. Use and the Method of Storing Data

- The data memory function can store 200 sets of weighing data. If the power switch is turned off, AC power is interrupted or the AC adapter is removed, the data is maintained in non-volatile memory.
- It is not necessary that the printer or computer be continually connected to the balance, because the balance stores the weight data in memory.
- There are four types of operating modes to store the data.

Key Mode When you press the **PRINT** key and the display value is stable, the balance stores the weighing data.

Auto-Print Mode A When the display value is stable and meets the conditions of "Auto-print polarity", "Auto-print band" and standard value (of zero point), the balance stores the weighing data.

Auto-Print Mode B When the display value is stable and meets the conditions of "Auto-print polarity", "Auto-print band" and standard value (of last stable value), the balance stores the weighing data.

Interval Memory Mode Weighing data is periodically stored in the balance. This mode can be started or stopped using the **PRINT** key.

- The data number can be appended just before the weighing data. (This is the serial number of the data in memory.)

Symbols

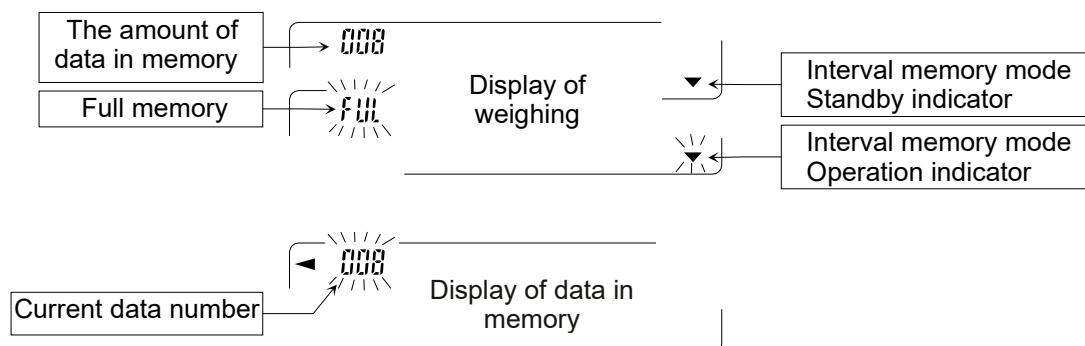

Caution

- When weighing data is being placed in memory, the data can be not output to the RS-232C interface.
- The "FUL" means full memory. More data can be not stored until deletion of the stored data.
- Automatic self calibration can not be used while the interval memory mode is working.
- The following commands can not be used during data storage.
 - Q Query command for weighing data.
 - S Request command for stable weighing data.
 - SI Query command for weighing data.
 - SIR Request command for continuous weighing data.



11.2.Preparation of the Function Table

Mode	Item	Data output mode	Auto-print polarity	Data memory function	Interval time
Key mode		<i>Pr</i> t 0	-	<i>dAtA</i> 1	-
Auto-Print Mode A		<i>Pr</i> t 1	<i>AP-P</i> 0 - 2		
Auto-Print Mode B		<i>Pr</i> t 2	<i>AP-b</i> 0 - 2		
Interval Memory Mode		<i>Pr</i> t 3	-		<i>int</i> 0 - 8

Not used data number	<i>d-no</i> 0
Use data number	<i>d-no</i> 1

Note

- The data memory function does not work with *dAtA* 0.



11.3.Enabling data memory function

- Step 1 Press and hold the **RANGE** key until **bASFnC** of the function table is displayed.
- Step 2 Press the **RANGE** key several times to display **dout**.
- Step 3 Press the **PRINT** key.
- Step 4 Press the **RANGE** key three times to display **dAtA 0**.
- Step 5 Press the **RE-ZERO** key to change **dAtA 0** to **dAtA 1**.
- Step 6 Press the **PRINT** key to save a new parameter.
- Step 7 Press the **CAL** key to return to the weighing mode.



11.4.Output of Data from Memory

Displaying and Transmitting the Data

- Step 1 Press and hold the **PRINT** key until displaying **rECALL** and release the key.
- Step 2 Press the **PRINT** key to enter the mode. Use the following keys.
 - RE-ZERO** key The key to proceed to the next data.
 - MODE** key The key to go back to the previous data.
 - PRINT** key The key to transmit the current data to the RS-232C interface.
 - RANGE** key While holding down the **RANGE** key, press the **CAL** key to delete the current data..
 - CAL** key The key to exit the **rECALL** mode.
- Step 3 Press the **CAL** key. The balance returns to weighing mode.

Transmitting All data at One Time

- Step 1 Setup the RS-232C interface using " **SIF** " of the function table. Refer to "9. Function Table" and "15. Introduction".
- Step 2 Press and hold the **PRINT** key until displaying **rECALL** and release the key.
- Step 3 Press the **RANGE** key to display **dout**.
- Step 4 Press the **PRINT** key to enter this mode.
- Step 5 Press the **RE-ZERO** key. Then the balance displays **dout 00**.
- Step 6 Press the **PRINT** key to transmit all data to RS-232C interface.
- Step 7 The balance displays **LEAr** after the finish.
- Step 8 Press the **CAL** key to return to weighing mode.

The Data Number

When the "Data number output (d-no)" is set to "1" and the data that is stored in the balance memory is to be output, the "Data number" can be appended just before each data. This format consists of six characters (excluding the terminator).

N	o	.	0	0	1	C _R	L _F									
S	T	,	+	0	0	0	.	1	2	7	8	□	□	g	C _R	L _F



11.5. Deleting All Data at One Time

- Step 1 Press and hold the **PRINT** key until displaying **rECALL** and release the key.
- Step 2 Press the **RANGE** key several times to display **CLER**.
- Step 3 Press the **PRINT** key to enter this mode.
- Step 4 Press the **RE-ZERO** key. Then the balance displays **CLr 00**.
- Step 5 Press the **PRINT** key to delete all data.
- Step 6 The balance displays **rECALL** after the finish.
- Step 7 Press the **CAL** key to return to weighing mode.



12. Underhook

The underhook can be used for weighing large items, magnetic material or density measurement. The built-in underhook is behind the plastic cap on the under-side of the balance.

Caution

- When not using the underhook, attach the plastic cap to prevent dust from getting into the balance.
- The underhook can only be used to support items within the weight range of the balance. Do not overload it.
- Operate the underhook gently.

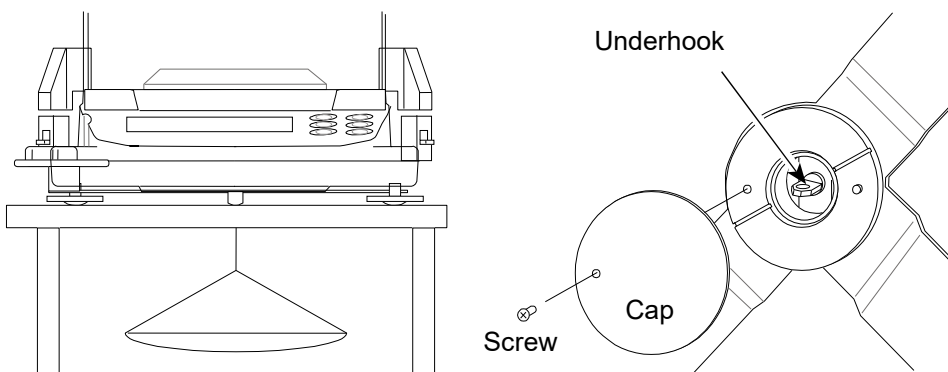



13. Specific Gravity (Density) Measurement

GR series balances are equipped with the specific gravity measuring mode. It calculates the density of a solid according to the weight of the sample in air and weight in liquid.

- The specific gravity measuring mode is not ready for use upon receiving the balance. To use the mode, change the function table and activate the specific gravity measuring mode.
- Two ways to set the density of a liquid are available:
by entering the water temperature and by entering the density directly.

Formula to obtain the density

The density can be obtained by the following formula.

$$\rho = \frac{A}{A - B} \times \rho_0$$

- ρ: Density of sample
- A: Density of sample in air
- B: Weight of sample in liquid
- ρ₀: Density of liquid

(1) Changing the function table

1 Setting the specific gravity measuring mode

The specific gravity measuring mode is available as one of the units. To use the mode, select it in the function table. For how to select the specific gravity measuring mode, see “Selecting a unit and arranging the sequence of display” in “4. Weighing Units” (Select Unit d)

2 Selecting the way to set the density of a liquid

Select the liquid density method from the function table below. The function table is available only when the specific gravity measuring mode is selected. For how to select, see “9. Function Table”.

Class	Item	Parameter	Summaries
dS Fnc Specific gravity measuring mode	L d in Liquid density	▪ 0	Enter the water temperature.
			Enter the density directly.

- Factory setting

(2) Setting the density of a liquid

(3) 1 Press the MODE key as necessary to select the specific gravity measuring mode.

When the processing indicator (upper left ◀) flashes with the unit “g” displayed, it indicates that the specific gravity measuring mode is selected.



2 In the specific gravity measuring mode, press and hold the MODE key to enter the mode to set the liquid density.

Note

- In the normal weighing mode, the same procedure will activate the automatic response adjustment. This function is not available in the specific gravity measuring mode.

(4) Entering the water temperature (L d in 0)

In the specific gravity measuring mode, press and hold the **MODE** key until the water temperature currently set (unit: °C, factory setting: 25°C) is displayed. Use the following keys to change the value.



- RE-ZERO** key Increases the temperature by one degree. (0-99°C)
- MODE** key..... Decreases the temperature by one degree. (0-99°C)
- PRINT** key..... Saves the change, displays **End** and returns to the specific gravity measuring mode.
- CAL** key..... Returns to the specific gravity measuring mode without saving the change.

The relation between the water temperature and density.

°C	+0	+1	+2	+3	+4	+5	+6	+7	+8	+9
0	0.99984	0.99990	0.99994	0.99996	0.99997	0.99996	0.99994	0.99990	0.99985	0.99978
10	0.99970	0.99961	0.99949	0.99938	0.99924	0.99910	0.99894	0.99877	0.99860	0.99841
20	0.99820	0.99799	0.99777	0.99754	0.99730	0.99704	0.99678	0.99651	0.99623	0.99594
30	0.99565	0.99534	0.99503	0.99470	0.99437	0.99403	0.99368	0.99333	0.99297	0.99259
40	0.99222	0.99183	0.99144	0.99104	0.99063	0.99021	0.98979	0.98936	0.98893	0.98849
50	0.98804	0.98758	0.98712	0.98665	0.98618	0.98570	0.98521	0.98471	0.98422	0.98371
60	0.98320	0.98268	0.98216	0.98163	0.98110	0.98055	0.98001	0.97946	0.97890	0.97834
70	0.97777	0.97720	0.97662	0.97603	0.97544	0.97485	0.97425	0.97364	0.97303	0.97242
80	0.97180	0.97117	0.97054	0.96991	0.96927	0.96862	0.96797	0.96731	0.96665	0.96600
90	0.96532	0.96465	0.96397	0.96328	0.96259	0.96190	0.96120	0.96050	0.95979	0.95906

(5) Entering the density directly (L d in 1)

In the specific gravity measuring mode, press and hold the **MODE** key until the density currently set (unit: g/cm³, factory setting: 1.0000g/cm³) is displayed. Use the following keys to change the value.

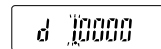

- RE-ZERO** (+) key.. Changes the numerical value of the digit selected.
- RE-ZERO** (-) key... Changes the numerical value of the digit selected.
- RANGE** key..... Selects the digit to change the value.
- PRINT** key..... Saves the change, displays **End** and returns to the specific gravity measuring mode.
- CAL** key..... Returns to the specific gravity measuring mode without saving the change.

Note

- The range to set the density is 0.0000–1.9999 g/cm³. (Displayed up to four decimal places)

(6) Measuring the density

In the density measurement, the balance displays the weight of the sample in air, the weight in liquid and then the density.

- Measuring the weight of the sample in air.

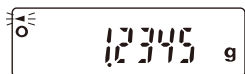

The processing indicator flashes with the unit “g” displayed.

- Measuring the weight of the sample in liquid.

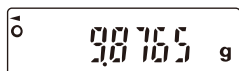

The processing indicator illuminates with the unit “g” displayed.

- Displaying the density.



The processing indicator illuminates with no unit displayed.

To switch between the above three, use the **RANGE** key.

(7) Measuring procedure

Step 1 Confirm that the balance is in the mode to measure the weight of the sample in air. (“g” displayed and processing indicator “◀” flashing)

Step 2 Confirm that the balance indicates zero. If it does not indicate zero, press the **RE-ZERO** key to reset the displayed value to zero.

Step 3 Place the sample on the upper pan (in air). When the value displayed on the balance becomes stable, press the **RANGE** key to confirm the value (the weight of sample in air). The balance enters the mode to measure the weight of sample in liquid (“g” displayed and processing indicator “◀” illuminating).

Note: If a negative value or E (error) is displayed, the **RANGE** key is disabled.

Step 4 Place the sample on the lower pan (in liquid). When the value displayed on the balance becomes stable, press the **RANGE** key to confirm the value (the weight of sample in liquid). The balance enters the mode to display the density (“g” not illuminated).

Note: If E (error) is displayed, the **RANGE** key is disabled.

Step 5 To output or save the density, press the **PRINT** key. The unit for outputting the density is “DS”. To measure the density of another sample, press the **RANGE** key to return to the mode to measure the weight in air and repeat the procedure described above.

Note: If the liquid temperature or the type of liquid is changed during measurement, reset the value of the liquid density as necessary. For details, see “(2) Setting the density of a liquid”.

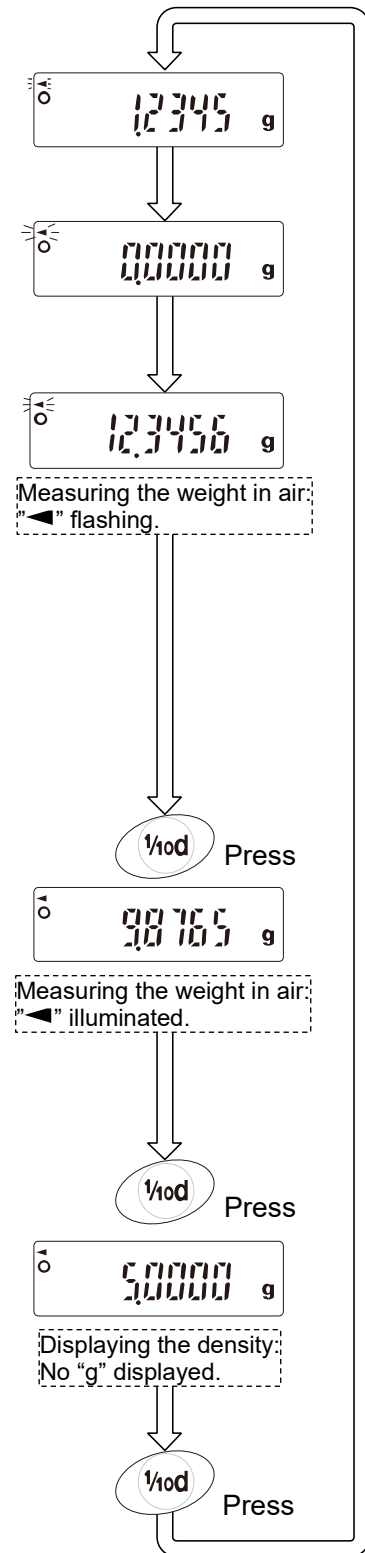



14. Input and Output Interface



14.1.RS-232C Interface

Transmission system: EIA RS-232C
 Transmission form: Asynchronous, bi-directional, half duplex
 Data format: Baud rate: 600, 1200, 2400, 4800, 9600 bps
 Data: 7 or 8 bits
 Parity: Even, Odd (7 bits), None (8 bits)
 Stop bit: 1 bit
 Code: ASCII

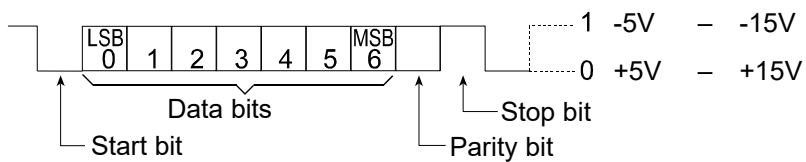

Pin connections

Pin No.	Signal name	Direction	Description
1	FG	-	Frame ground
2	RXD	Input	Receive data
3	TXD	Output	Transmit data
4	RTS	Input	Ready to send
5	CTS	Output	Clear to send
6	DSR	Output	Data set ready
7	SG	-	Signal ground
8-25	N.C.	-	-

Circuits

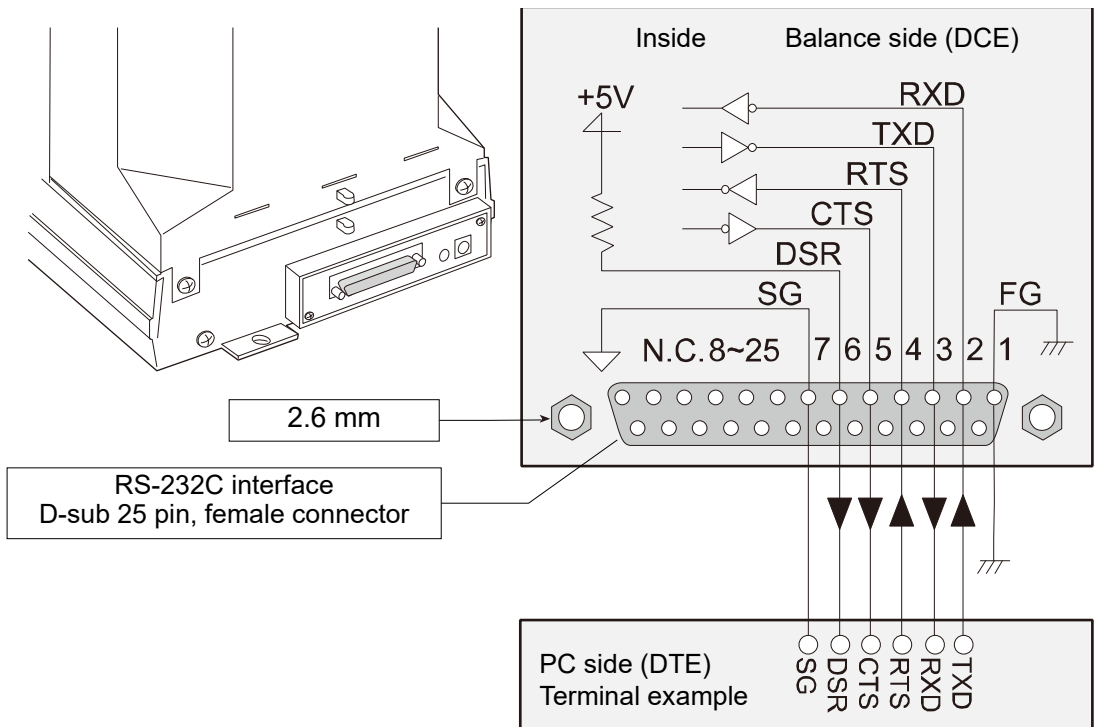



14.2.External Contact Input

External contact input terminal

Compatible plug: $\phi 3.5$ mm 3-pole stereo plug
MP-013LC or the equivalent

Appearance diagram

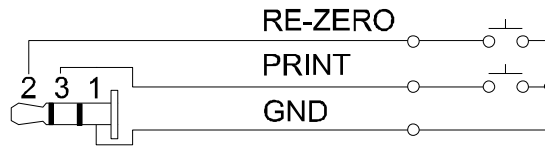
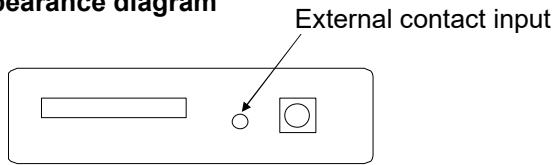

Example of external contact input terminal

External contact input circuit

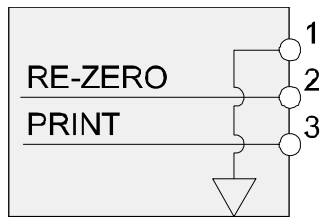

Pin assignments

Pin No.	Description
1	GND
2	RE-ZERO External contact input
3	PRINT External contact input

When pin 1 and pin 3 or pin 1 and pin 2 are shorted 100 ms or longer, the switch can operate the balance in the same way as the balance **PRINT** key or the **RE-ZERO** key, respectively.

□ AX-SW137-PRINT or AX-SW137-REZERO (optional foot switches sold separately) can be used.



15. Connection to Equipment



15.1. Connection to AD-8127 Printer

When connecting an AD-8127 printer to the balance for printing weighing data, configure the printer and the balance as follows.

Printer

Example of use	AD-8127 Printing mode settings
For printing the weighing data of the balance using the balance's PRINT key or auto print mode.	EXT.KEY
For printing weighing data of the balance using the printer's print key or interval printing mode. For printing in chart printing mode of the printer.	MANUAL AUTO TIMER CHART
For printing the statistical calculation results of the balance. For printing the GLP output of the balance.	DUMP

- To change the settings of the AD-8127 printer, refer to the AD-8127 instruction manual.

Balance

Example of use	Balance <i>PrE</i> Data output mode	Balance <i>PYPPE</i> Data format
For printing the weighing data of the balance using the balance's PRINT key or auto print mode.	0, 1, 2	0
For printing weighing data of the balance using the printer's print key or interval printing mode. For printing in chart printing mode of the printer.	3	0
For printing the GLP output of the balance.	0, 1, 2	1

- To change the settings of the balance, refer to "9. Function Table".



15.2. Connection to AD-8121B Printer

When connecting an AD-8121B printer to the balance for printing weighing data, configure the printer and the balance as follows.

Class	Item	Default	AD-8121B MODE 1	AD-8121B MODE 2	AD-8121B MODE 3
<i>dout</i> Data output	<i>PrE</i> Data output mode	0	0, 1, 2	3	0, 1, 2
	<i>RP-P</i> Auto-print polarity	0	* 1	No setting required	* 1
	<i>RP-b</i> Auto-print difference	1			
	<i>d-no</i> Data number output	0	0	0	0, 1
	<i>PUSE</i> Data pause	0	0	0	0, 1
	<i>At-F</i> Auto feed	0	0	0	0, 1

SIF Serial interface	bPS Baud rate	2	2	2	2
	bLPr Length, Parity bit	0	0	0	0
	rLF Terminator	0	0	0	0
	tYPE Data format	0	0	0	1
	tS CTS, RTS control	0	0	0	0

* 1 Set when the data output mode is auto print mode (PrL 1 or PrL 2).

Note

- For print samples, "10. ID Number and GLP Report".
- AD-8121B settings

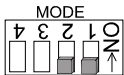
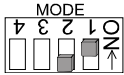
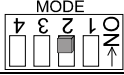
Mode	AD-8121B DIP switch	Description
MODE 1		Prints when data is received Standard mode, statistical calculation mode
MODE 2		Printed by DATA key and built-in timer Standard mode, interval mode, chart mode
MODE 3		Prints when data is received Dump printing mode

The DIP switch 3 is for unstable data:

- ON To print unstable data.
- OFF Not to print unstable data.

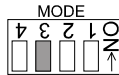

The DIP switch 4 is for data input specification:

- ON To input via current loop.
- OFF To input via RS-232C.

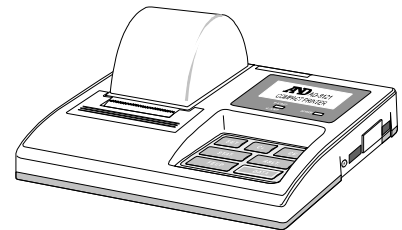
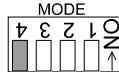



15.3. Connection to Computer

The GR series balance is of the DCE type (Data Communication Equipment), which can be connected to a personal computer using the RS-232C interface. Before connection, read the personal computer manual thoroughly. Use a standard DCE cable for connection (cable type: straightthrough). To connect to a computer that does not have a serial port, we recommend using an optional USB converter (AX-USB-25P).

Using Windows Communication Tools Software (WinCT)

When Windows is used as an operating system in a personal computer, the WinCT software can be used to transmit the weighing data to the personal computer. The current version of the WinCT can be downloaded from the A&D website. Confirm the windows version supported by this software when downloading. Refer to the WinCT instruction manual on the A&D website. The WinCT software has three communication methods: "RsCom" , "RsKey" and "RsWeight".

"RsCom"

- Can transmit commands to control the balance.
- Can make a bi-directional communication between the balance and a personal computer using the RS-232C interface.
- Can display or store the data using a text file format. Can also print the data using a printer connected to the personal computer.
- When several ports of a personal computer have balances connected, can communicate with each balance simultaneously.
- Can share a personal computer with other application software.
- Can receive the balance GLP report.

"RsKey"

- Can transmit the weighing data output from the balance directly to other application software such as Microsoft Excel.
- Can be used with most application software.
- Can receive the balance GLP report.

"RsWeight"

- Can retrieve the weight data from the balance and display the data as a graph in real time.
- Can calculate and display the maximum, minimum, average, standard deviation and coefficient of variation.

Using the WinCT software, the balance can do the following:

- Analyzing the weighing data and the statistics input by "RsKey"
The weighing data can be input directly into an Excel worksheet. Then, Excel can analyze the data to obtain total, average, standard deviation, maximum and minimum values, and display them in a graph.
- Controlling the balance using commands from a personal computer
By using "RsCom", the personal computer sends commands such as "re-zero" or "send weighing data" to the balance and controls the balance.
- Printing the balance GLP report using your printer
The balance GLP report can be printed using a printer connected to the personal computer.
- Receiving weighing data at a certain interval
The weighing data can be received at a certain interval and data characteristic with elapsed time can be obtained.

- Using the balance memory function
The data can be stored in the balance's memory. Of the data stored, the weighing data and calibration data can be transmitted to a personal computer at one time.
- Using a personal computer as an external indicator
With the "RsKey" test mode function, a personal computer can be used as an external weight indicator for the balance. (To do this, set the balance data output mode to stream mode.)



16. Commands



16.1.Command List

Commands to request weighing data

C	Cancel command for the SIR command.
Q	Query command for weighing data.
S	Request command for stable weighing data.
SI	Query command for weighing data.
SIR	Request command for continuous weighing data.

Commands to control the balance

CAL	Calibration command.
MCL	Command to delete all stored data.
MD:nnn	Command to delete data of data number nnn.
OFF	Display OFF command.
ON	Display ON command.
P	Same as the ON:OFF key, Display ON/OFF command.
PRT	Same as the PRINT key.
R	Same as the RE-ZERO key, RE-ZERO command.
RNG	Same as the RANGE key, Range command.
TST	Calibration test command.
U	Same as the MODE key, Unit command.

Commands to request stored data

?MA	Output command to transmit all memory data.
?MQnnn	Request command to transmit data of data number nnn.
?MX	Query command for last data number.

nnn: numerical value of three figures



16.2.Commands to Request Weighing Data

C Cancel command for the SIR command

The balance will stop sending data in stream mode.

Command

C	C _R	L _F
---	----------------	----------------

Reply (Output is stopped)

Q Query command for weighing data

The balance will respond with the weighing data immediately.

Command

Q	C _R	L _F
---	----------------	----------------

Reply

U	S	,	+	0	0	0	.	1	2	7	8	┐	┐	g	C _R	L _F
---	---	---	---	---	---	---	---	---	---	---	---	---	---	---	----------------	----------------

S Request command for stable weighing data

The balance display will blink when the data is transmitted.

Command

S	C _R	L _F
---	----------------	----------------

Reply

S	T	,	+	0	0	0	.	1	2	7	8	┐	┐	g	C _R	L _F
---	---	---	---	---	---	---	---	---	---	---	---	---	---	---	----------------	----------------

SIR Request command for continuous weighing data

The balance sends the data in stream mode.

Command

S	I	R	C _R	L _F
---	---	---	----------------	----------------

Reply

S	T	,	+	0	0	0	.	1	2	7	9	┐	┐	g	C _R	L _F
S	T	,	+	0	0	0	.	1	2	7	8	┐	┐	g	C _R	L _F
S	T	,	+	0	0	0	.	1	2	7	7	┐	┐	g	C _R	L _F

⋮

Caution

- When the baud rate is set to 2400bps or less, the display update rate is faster than the output rate and the balance may not transmit the data completely (and transmits it intermittently).



16.3. Commands to Control the Balance

- CAL Calibration command
Balance performs calibration using the internal weight.
Command

C	A	L	C _R	L _F
---	---	---	----------------	----------------

Reply (Balance is calibrated)
- MCL Command to delete all stored data.
Command

M	C	L	C _R	L _F
---	---	---	----------------	----------------

Reply (<AK> code is replied)
- MD:nnn Command to delete data of data number nnn.
Command

M	D	:	0	2	1	C _R	L _F
---	---	---	---	---	---	----------------	----------------

Reply (<AK> code is replied)
- OFF Display OFF command
If the balance is ON, it will turn OFF. If the balance is already off, nothing will happen.
Command

O	F	F	C _R	L _F
---	---	---	----------------	----------------

Reply (Balance turns off)
- ON Display ON command If the balance is OFF, it will turn ON.
Command

O	N	C _R	L _F
---	---	----------------	----------------

Reply (Balance turns on)
- P Same as the

ON:OFF

 key, Display ON/OFF command.
The balance turns on (or turns off). The command works as the

ON:OFF

 key.
Command

P	C _R	L _F
---	----------------	----------------

Reply (Balance turns on or off alternately)
- PRT Same as the

PRINT

 key, Print command. The command works as the

PRINT

 key.
Command

P	R	T	C _R	L _F
---	---	---	----------------	----------------

Reply (Data is output once)
- R Same as the RE-ZERO key, RE-ZERO command.
The balance will display zero. The command works as the

RE-ZERO

 key.
Command

R	C _R	L _F
---	----------------	----------------

Reply (Zero is displayed)
- RNG Same as the

RANGE

 key, Range command.
The range can be changed. The command works as the

RANGE

 key.
Command

R	N	G	C _R	L _F
---	---	---	----------------	----------------

Reply (Sample weight is stored in the balance)

- TST Calibration test command
 The balance performs the calibration test using the internal weight.
 Command

T	S	T	C _R	L _F
---	---	---	----------------	----------------

 Reply (Calibration test is performed)
- U Same as the

MODE

 key, Unit command.
 The unit can be changed. The command works as the

MODE

 key.
 Command

U	C _R	L _F
---	----------------	----------------

 Reply (Unit is changed)



16.4. Commands to Request Memory Data

- ?MA Output command to transmit all memory data.
 Command

?	M	A	C _R	L _F
---	---	---	----------------	----------------

 Reply (when the data number is used)

N	o	.	0	0	1	C _R	L _F									
S	T	,	+	0	0	0	.	1	2	7	8	□	□	g	C _R	L _F
N	o	.	0	0	2	C _R	L _F									
S	T	,	+	0	0	0	.	1	2	8	8	□	□	g	C _R	L _F
N	o	.	0	0	3	C _R	L _F									
S	T	,	+	0	0	0	.	1	2	9	8	□	□	g	C _R	L _F

 ⋮
- ?MQnnn Request command to transmit data of data number nnn.
 Command

?	M	Q	0	2	2	C _R	L _F
---	---	---	---	---	---	----------------	----------------

 Reply (when the data number is not used)

S	T	,	+	0	0	0	.	1	2	9	8	□	□	g	C _R	L _F
---	---	---	---	---	---	---	---	---	---	---	---	---	---	---	----------------	----------------
- ?MX Query command for last data number.
 Command

?	M	X	C _R	L _F
---	---	---	----------------	----------------

 Reply

N	o	.	1	2	6	C _R	L _F
---	---	---	---	---	---	----------------	----------------



16.5. Acknowledge Code and Error Codes

This is an explanation of *ErrCd* of the function list
<AK> (06h) ----Acknowledge in ASCII code.

In the Case of *ErrCd* 0

- The balance does not output <AK> code or the error code.

In the Case of *ErrCd* 1

- When the balance received a command requesting data and cannot process it, the balance transmits an error code (EC, Exx). When the balance is able to process a command requesting data, the balance outputs the data.
- When the balance receives a command to control the balance and can not process it, the balance transmits an error code (EC, Exx). When the balance receives a command to control the balance and can process it, the balance transmits <AK> (06h) code.
- There are some commands that transmit plural <AK> (06h) code from the balance. See "Command Examples"

CAL command (Calibration command)

ON command (ON command)

P command (ON:OFF command)

R command (RE-ZERO command)

TST command (Calibration test)

- When a communication error has occurred due to external noise, or a parity error has occurred due to transmission error, the balance transmits an error code. In this case, send the command once more.



16.6. Control using CTS and RTS

This is an explanation of *ErrS* of the function list.

In the Case of *ErrS* 0

Regardless of whether the balance can receive a command or not, the balance keeps the CTS line to HI. The balance outputs data regardless of the condition of the RTS line.

In the Case of *ErrS* 1

The CTS line is kept HI normally. When the balance can not receive the next command (ex. processing last command), the balance sets CTS line to LO. The balance confirms the level of the RTS line when data can be output. If the RTS level is HI, the balance outputs data. If the RTS level is LO, data is not output (It cancels data output).



16.7. Related Settings

The balance has internal settings related to RS-232C output, "data output (*dout*)" and "serial interface (*SIF*)." Set according to usage.



16.8.Command Examples

This example is set to "ErCd 1" of "SIF" so as to output the <AK> code.

ON command (to turn on the display)

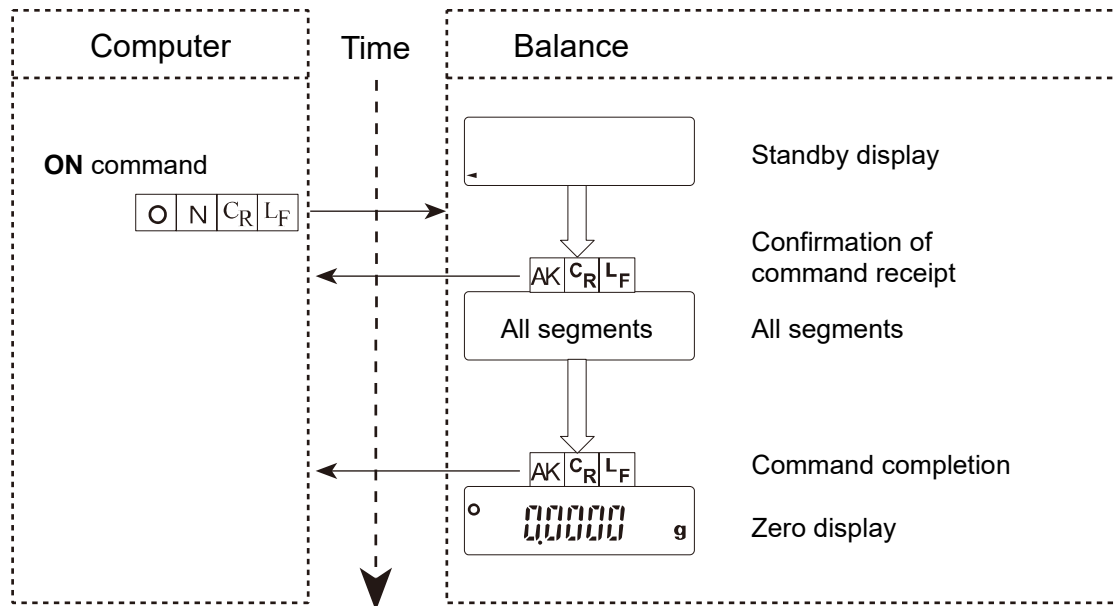

R command (to zero the display)

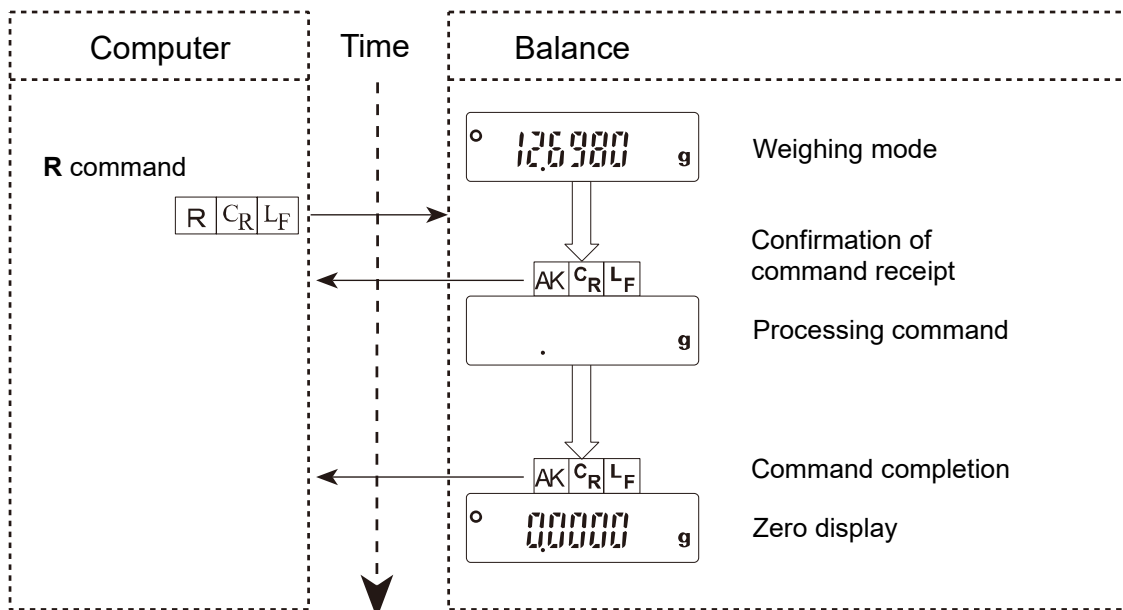

CAL command (to calibrate the balance)

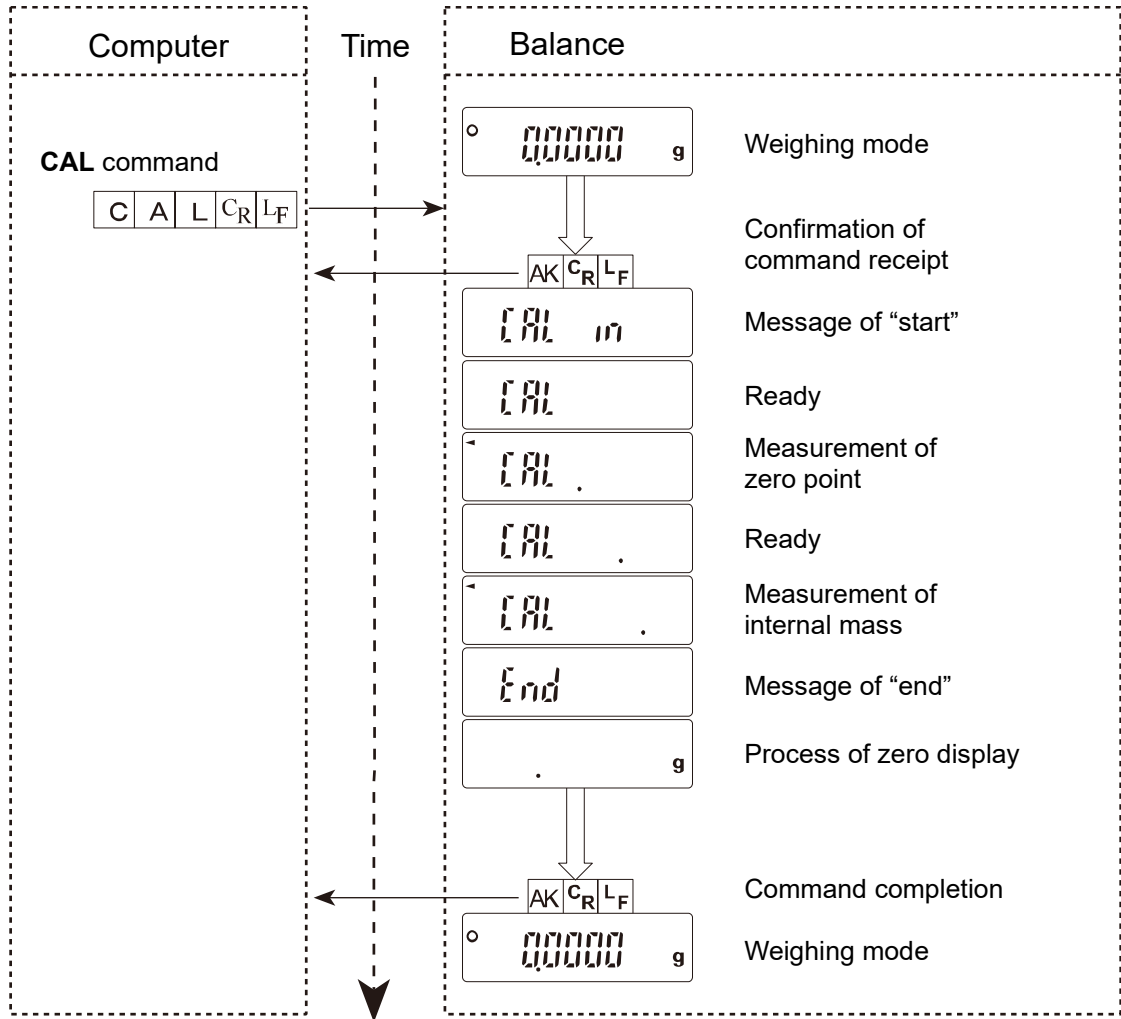

Error code and command cancellation

Example: When the R command is received, but the balance cannot process it and an error code is output. This example is set to "ErCd 1" of "SIF".

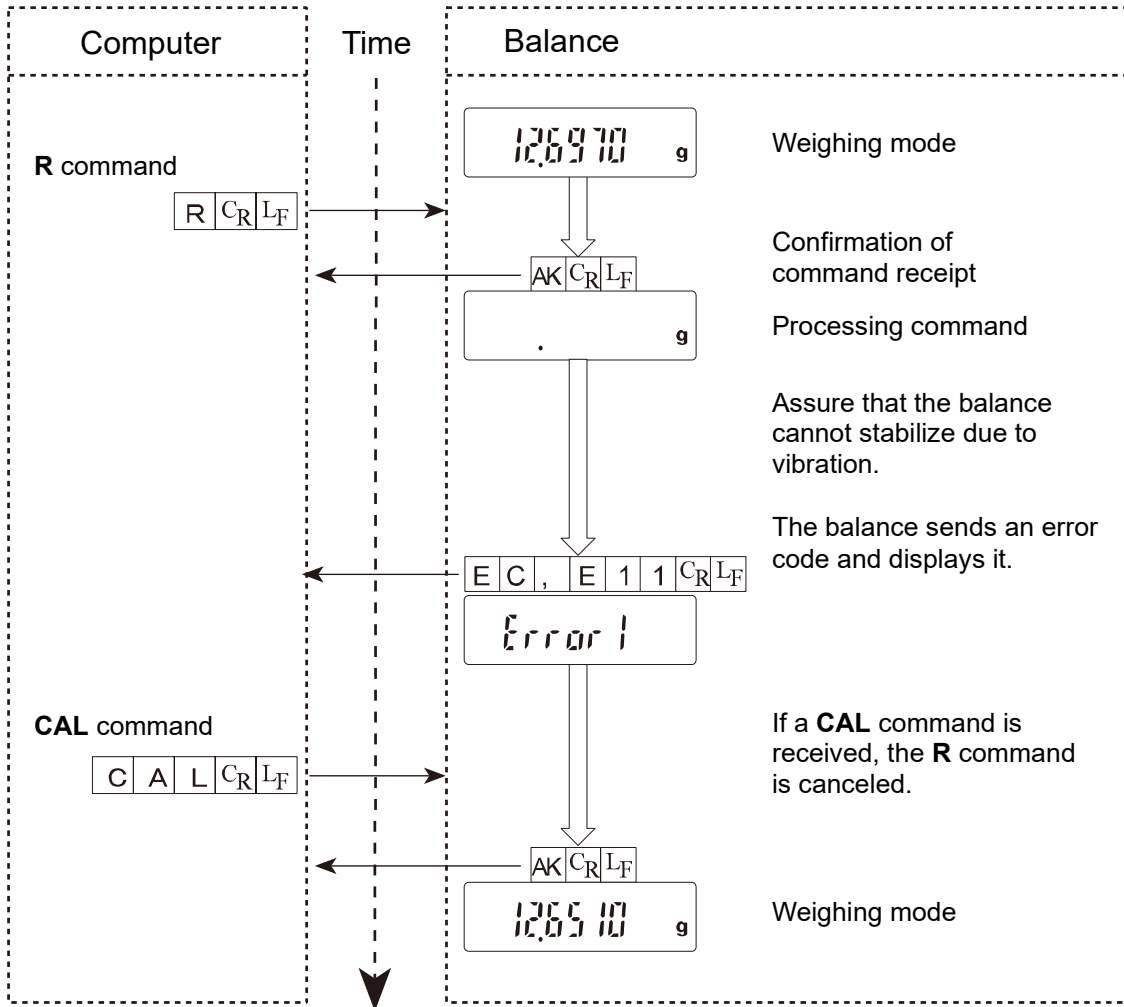



17. Maintenance









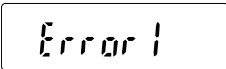

17.1. Treatment of the Balance

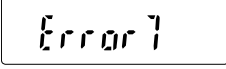
- Do not disassemble the balance. Contact your local A&D dealer if your balance needs service or repair.
- Please use the original shipping box for transportation.
- Do not use organic solvents to clean the balance. Use a warm lint free cloth that is damp, along with a detergent for cleaning.
- The "Floor Plate of the Weighing Chamber" can be removed and cleaned.
- Consider section "2. Caution".

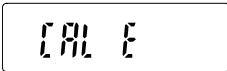
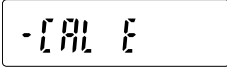
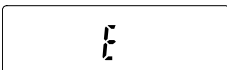
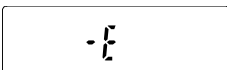
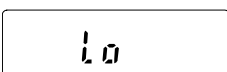
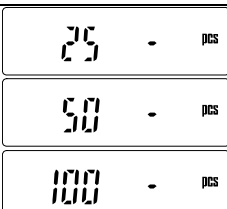

17.2. Error codes

Display	Error code	Description of the error
	EC,E00	Communications error A protocol error occurred in communications. Confirm the format, baud rate and parity.
	EC,E01	Undefined command error An undefined command was received. Confirm command.
	EC,E02	Not ready A received command cannot be processed. Adjust the delay time to transmit the command. ex. The balance received a Q command, but not in the weighing mode. ex. The balance received a Q command while processing a RE-ZERO command.
	EC,E03	Time over error If <i>t-UP 1</i> of the function list is set, the balance did not receive the next character of a command within the time limit of one second. Confirm communication.
	EC,E04	Excess characters error The balance received excessive characters in a command. Confirm command.
	EC,E06	Format error A command includes incorrect data. Confirm command. ex. Data is numerically incorrect.
	EC,E07	Range error for a parameter The received data exceeds the range that the balance can accept. Confirm parameter range of command
	EC,E11	Stability error The balance cannot stabilize due to an environmental problem. Press the CAL key to return to the weighing mode. Prevent vibration, drafts, temperature changes, static electricity and magnetic fields. Read "2.1. Precautions for Installing the Balance" and "2.2. Cautions during use (To get best performance)" and be well informed on how to use the balance.
	EC,E16	Internal weight error This is a calibration error. Confirm that there is nothing on the pan and retry the calibration or calibration test.
	EC,E17	Internal weight error This is a calibration error. Retry the calibration or calibration test.

Display	Error code	Description of the error
	EC,E20	Calibration error The calibration weight is too heavy. Press the CAL key to return to the weighing mode.
	EC,E21	Calibration error The calibration weight is too light. Press the CAL key to return to the weighing mode.
		Over load This is a warning that a weight beyond the balance capacity has been placed on the pan. Remove the weight from the pan.
		Weighing pan Error This is a warning that the weight value is too light. Confirm that the weighing pan and the pan support are properly installed.
		Unit weight, 100% weight error The unit weight of the sample is very light in the counting mode, or the 100% sample is too light in percent mode. The balance can not calculate it. Increase the unit weight or 100% weight.
		Unit weight information This is advice regarding the sample number that is needed to set the unit weight. When the unit weight is computed and the sample number is too few, the required number is displayed for counting accuracy. Count and place the samples on the pan. Press the PRINT key to store the correct value.
		ARA Zero error The ARA (Automatic Response Adjustment) cannot be performed, because there is something on the pan. Remove all matter from the pan. Press the CAL key to return to the weighing mode.
		ARA Unstable error The ARA (Automatic Response Adjustment) cannot be performed because of unstable weighing value. Correct the environment for the balance. Press the CAL key to return to the weighing mode.
		Low battery (low voltage) error The voltage supplied to the balance is low. Check if the correct AC adapter is used.
	(blinking)	Full memory The memory data has reached 200 items. When data is deleted, new data can be stored.
		Memory data error The memory data is lost. Clear all memory data.



17.3. Other Display



When this indicator (◀) blinks, automatic self calibration is required. The indicator blinks when the balance detects changes in ambient temperature. If the balance is not used for several minutes with this indicator blinking, the balance performs automatic self calibration. The blinking period depends on the operating environment.

Advise

- The balance can be used while this indicator is blinking. We recommend that you perform automatic self calibration for precision weighing.



18. Specifications

	GR-120	GR-200	GR-300	GR-202
Weighing capacity	120 g	210 g	310 g	210 g/42 g
Readability	0.1 mg	0.1 mg	0.1 mg	0.1 mg/0.01 mg
Repeatability (Standard deviation)	0.1 mg	0.1 mg	0.2 mg	0.1 mg/0.02 mg
Linearity	±0.2 mg	±0.2 mg	±0.3 mg	±0.2 mg/0.03 mg
Stabilization time (approx.)	3.5 sec	3.5 sec	3.5 sec	3.5 sec/8 sec
Sensitivity drift (10°C – 30°C)	±2 ppm/°C (when automatic self calibration is not used)			
Ambient temperature	5°C – 40°C (41°F – 104°F), 85%RH or less (no condensation)			
Min. unit weight	0.1 mg			
Min. 100% weight	0.01 g			
Interface	RS-232C			
Calibration weight	Built-in weight			
External calibration weight	100 g 50 g	200 g 100 g	200 g 300 g	200 g 100 g
Weighing pan	φ85 mm			
Weighing chamber	178(W) x 160(D) x 233(H) mm			
External dimensions	249(W) x 330(D) x 327(H) mm			
Power consumption	Approx. 30VA (supplied to AC adapter)			
Current consumption	DC12V, approx 0.3A (excluding the AC adapter and options)			
AC adapter, Power supply	Please confirm that the AC adapter is correct for your receptacle type and voltage [factory preset].			
Net weight	Approx. 6.0 kg			



18.1.External Dimensions

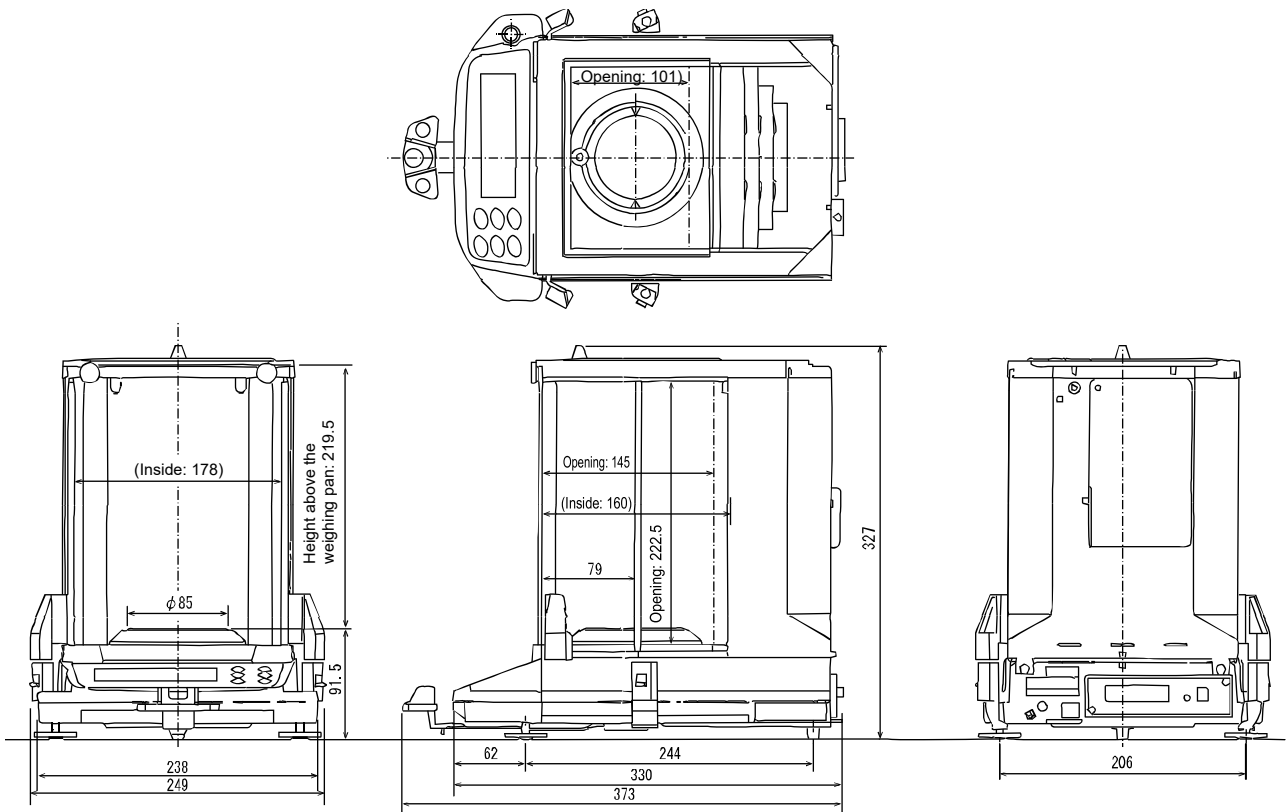

Unit: mm



18.2.Optional Accessories

List of accessories (sold separately)

AD-8127: Multi printer

- Small dot impact printer that connects to the balance via the RS-232C interface.
- Statistical calculation mode, calendar/clock function, interval printing mode, chart printing mode, dump printing mode.

AD-1687: Weighing environment logger

- A data logger equipped with 4 sensors for temperature, humidity, barometric pressure and vibration that can measure and store environmental data. When connected to the RS-232C interface of the balance, the AD-1687 can store environmental data along with weighing data. Therefore, it is possible to store data in an environment where a computer cannot be used. Special software is not required to read the data.

AD-1688: Data logger

- When connected to the RS-232C interface of the balance, the AD-1688 can store the data in an environment where a personal computer cannot be used.

AD-8526: Ethernet converter

- This converter can be used to connect the RS-232C interface of the balance to the Ethernet (LAN) port of a computer. This allows management of the balance weighing data with a computer connected to a network.
- WinCT can be downloaded from our website <https://www.aandd.jp>.

AD-8527: Quick USB adapter

- Transmits the weighing data directly to software applications such as Excel and Word. IP65 compliant.

AD-8920A: Remote display

- A remote display for displaying the weighing data transmitted by the balance using either RS-232C or current loop.

AD-8922A: Remote controller

- Connected to the RS-232C interface, display ON/OFF, calibration, data output, readability switching, unit switching, rezero, etc. can be operated remotely from the balance.

AX-USB-25P: USB converter

- Can use serial communication software such as WinCT on a personal computer without COM ports. Enables bi-directional communication between the personal computer and the balance when a USB driver is installed.

AD-1671: Anti-vibration table

- With a weight of approx. 27 kg and shock-absorbing rubber, it reduces vibrations from the floor and is effective for stable weighing display on the balance.

AD-1672: Tabletop breeze break

- Protects the balance from wind from sources such as air conditioning or people passing by, thereby reducing balance weighing errors. The transparent panel assembly consists of antistatic plastic material that protects the balance from static electricity.

AD-1683A: Ionizer (Static eliminator)

- Prevents error which can be caused when weighing samples are electrically charged.
- Its direct-current system and plentiful ion content enable weighing without breeze, which is ideally suited for precisely measuring powder and such.
- The built-in IR Sensor enables removal of static electricity in a touchless way.

AD-1684A: Electrostatic field meter

- Measures the amount of the static charge on the sample, tare or peripheral equipment and displays the result. If those are found to be charged, discharge them using an ionizer such as AD-1683A.

AD-1682: Rechargeable battery

- Allows use of the balance in a place where AC power is not available.

AD-1689: Tweezers for calibration weight

- A pair of tweezers ideally suited for holding calibration weights of 1 g to 500 g.
- Total length 210mm. With tweezer tip caps.

AX-SW137-PRINT : Foot switch print function with a plug

- The foot switch has the same function as the **PRINT** key.

AX-SW137-REZERO : Foot switch rezero function with a plug

- The foot switch has the same function as the **RE-ZERO** key.



A&D Company, Limited

3-23-14 Higashi-Ikebukuro, Toshima-ku, Tokyo 170-0013, JAPAN
Telephone: [81] (3) 5391-6132 Fax: [81] (3) 5391-1566

A&D ENGINEERING, INC.

47747 Warm Springs Blvd, Fremont, California 94539, U.S.A.
Tel: [1] (800) 726-3364 Weighing Support:[1] (888) 726-5931 Inspection Support:[1] (855) 332-8815

A&D INSTRUMENTS LIMITED

Unit 24/26 Blacklands Way, Abingdon Business Park, Abingdon, Oxfordshire OX14 1DY United Kingdom
Telephone: [44] (1235) 550420 Fax: [44] (1235) 550485

A&D AUSTRALASIA PTY LTD

32 Dew Street, Thebarton, South Australia 5031, AUSTRALIA
Telephone: [61] (8) 8301-8100 Fax: [61] (8) 8352-7409

A&D KOREA Limited

한국에이.엔.디(주)
서울특별시 영등포구 국제금융로6길33 (여의도동) 맨하탄빌딩 817 우편 번호 07331
(817, Manhattan Bldg., 33. Gukjegeumyung-ro 6-gil, Yeongdeungpo-gu, Seoul, 07331 Korea)
전화: [82] (2) 780-4101 팩스: [82] (2) 782-4264

OOO A&D RUS

ООО "ЭЙ энд ДИ РУС"

Почтовый адрес:121357, Российская Федерация, г.Москва, ул. Вереysкая, дом 17
Юридический адрес: 117545, Российская Федерация, г. Москва, ул. Дорожная, д.3, корп.6, комн. 86
(121357, Russian Federation, Moscow, Vereyskaya Street 17)
тел.: [7] (495) 937-33-44 факс: [7] (495) 937-55-66

A&D Instruments India Private Limited

ऐ&डी इन्स्ट्रुमेंट्स इण्डिया प्रा० लिमिटेड

509, उद्योग विहार , फेस -5, गुडगांव - 122016, हरियाणा , भारत
(509, Udyog Vihar, Phase-V, Gurgaon - 122016, Haryana, India)
फोन : [91] (124) 4715555 फैक्स : [91] (124) 4715599

A&D SCIENTECH TAIWAN LIMITED. A&D台灣分公司 艾安得股份有限公司

台灣台北市中正區青島東路5號4樓
(4F No.5 Ching Tao East Road, Taipei Taiwan R.O.C.)
Tel : [886](02) 2322-4722 Fax : [886](02) 2392-1794

A&D INSTRUMENTS (THAILAND) LIMITED

บริษัท เอ แอนด์ ดี อินสตรูमेंท์ (ไทยแลนด์) จำกัด

168/16 หมู่ที่ 1 ตำบลรังสิต อำเภอธัญบุรี จังหวัดปทุมธานี 12110 ประเทศไทย
(168/16 Moo 1, Rangsit, Thanyaburi, Pathumthani 12110 Thailand)
Tel : [66] 20038911