



Thermo Scientific SL 8 Series

Instruction Manual

50143237-j • 2022-11

Contents

Preface	6
Intended Use	6
Signal Words and Symbols	6
Symbols used on Centrifuge and Accessories	6
Symbols used in the Instruction Manual	7
Safety Instructions	7
<hr/>	
1. Transport and Set Up	10
1. 1. Unpacking	10
Items Supplied	10
1. 2. Location	10
1. 3. Transporting	11
Handling Benchtop Centrifuges	11
1. 4. Mains Connection	12
<hr/>	
2. Operation	13
2. 1. Control Panel	13
2. 2. Power on / off the Centrifuge	14
2. 2. 1. To power on the centrifuge	14
2. 2. 2. To power off the centrifuge	14
2. 3. Open / Close the Centrifuge Door	14
2. 3. 1. To open the centrifuge door	14
2. 3. 2. To close the centrifuge door	14
2. 4. How to Operate a Rotor	15
2. 4. 1. How to install a rotor	15
2. 4. 2. How to remove a rotor	15
2. 5. Load the Rotor	16
2. 5. 1. Balance Loading	16
RCF Value Explained	18
2. 6. Entering Centrifugation Parameters	19
2. 6. 1. Acceleration / Deceleration Profiles	19
2. 6. 2. Selecting Speed / RCF	19
2. 6. 3. Setting the Running Time	19
2. 6. 4. Continuous Operation	20
2. 6. 5. Selecting the Temperature	20
2. 6. 6. Prewarming or Precooling the Centrifuge	20
2. 7. Programs	21
2. 7. 1. Saving a Program	21
2. 7. 2. Loading a Program	21
2. 7. 3. Programs Only Mode	21
2. 8. Centrifugation	21
Starting Centrifugation	22
Stopping Centrifugation	22
2. 9. Short-term Centrifugation	22
2. 10. Aerosol-tight Applications	23
2. 10. 1. Basic Principles	23

2. 10. 2. Fill Level	23
2. 10. 3. Aerosol-Tight Rotor Lids.....	23
2. 10. 4. Aerosol-Tight Rotor Buckets	24
2. 10. 5. Checking Aerosol Tightness.....	24
Quick Test.....	24
3. System Menu.....	26
Flowchart System Menu	26
4. Maintenance and Care	27
4. 1. Cleaning Intervals.....	27
4. 2. Basics	27
4. 2. 1. Rotor and Accessories Inspection	27
4. 2. 2. Cycles of Rotors and Buckets	28
4. 3. Cleaning	28
Cleaning the Filter Mat.....	29
4. 4. Disinfection.....	29
4. 5. Decontamination	29
4. 6. Autoclaving	30
4. 7. Service.....	30
4. 8. Lifetime	30
4. 9. Shipping.....	30
4. 10. Storage	31
4. 11. Disposal.....	31
5. Troubleshooting.....	32
5. 1. Mechanical Emergency Lid Release	32
5. 2. Ice Formation	33
5. 3. Troubleshooting by Guide	33
5. 3. 1. Information for the Customer Service	34
6. Technical Specifications.....	35
6. 1. List of Centrifuges	35
6. 2. List of Rotors	35
6. 3. Technical Data	36
Thermo Scientific SL 8.....	36
Thermo Scientific SL 8R.....	37
6. 3. 1. Directives and Standards	38
6. 3. 2. Mains Supply	39
6. 3. 3. Refrigerants.....	39
7. Rotor Specifications	40
7. 1. TX-150	40
7. 1. 1. Items Supplied	40
7. 1. 2. Technical Data	40
7. 1. 3. Rotor Performance Data.....	40
7. 1. 4. Accessories.....	42
7. 1. 5. Biocontainment Certificate.....	43
7. 2. TX-100S.....	44

7. 2. 1. Items Supplied	44
7. 2. 2. Technical Data	44
7. 2. 3. Rotor Performance Data.	44
7. 2. 4. Accessories.	45
7. 2. 5. Biocontainment Certificate.	45
7. 3. TX-100	46
7. 3. 1. Items Supplied	46
7. 3. 2. Technical Data	46
7. 3. 3. Rotor Performance Data.	46
7. 3. 4. Accessories.	47
7. 4. M10	48
7. 4. 1. Items Supplied	48
7. 4. 2. Technical Data	48
7. 4. 3. Rotor Performance Data.	48
7. 4. 4. Accessories.	49
7. 4. 5. Biocontainment Certificate.	50
7. 5. MT-12.	51
7. 5. 1. Items Supplied	51
7. 5. 2. Technical Data	51
7. 5. 3. Rotor Performance Data.	51
7. 5. 4. Accessories.	52
7. 6. HIGHConic III	53
7. 6. 1. Items Supplied	53
7. 6. 2. Technical Data	53
7. 6. 3. Rotor Performance Data.	53
7. 6. 4. Accessories.	54
7. 6. 5. Biocontainment Certificate.	55
7. 7. CLINIConic	56
7. 7. 1. Items Supplied	56
7. 7. 2. Technical Data	56
7. 7. 3. Rotor Performance Data.	56
7. 7. 4. Accessories.	57
7. 8. MicroClick 18 x 5	58
7. 8. 1. Items Supplied	58
7. 8. 2. Technical Data	58
7. 8. 3. Rotor Performance Data.	58
7. 8. 4. Accessories.	58
7. 8. 5. Biocontainment Certificate.	59
7. 9. MicroClick 24 x 2	60
7. 9. 1. Items Supplied	60
7. 9. 2. Technical Data	60
7. 9. 3. Rotor Performance Data.	60
7. 9. 4. Accessories.	61
7. 9. 5. Biocontainment Certificate.	61
7. 10. MicroClick 30 x 2	62
7. 10. 1. Items Supplied	62
7. 10. 2. Technical Data	62
7. 10. 3. Rotor Performance Data.	62
7. 10. 4. Accessories.	63
7. 10. 5. Biocontainment Certificate.	63

7. 11. Microliter 48 x 2	64
7. 11. 1. Items Supplied	64
7. 11. 2. Technical Data	64
7. 11. 3. Rotor Performance Data.....	64
7. 11. 4. Accessories.....	65
7. 11. 5. Biocontainment Certificate.....	65
7. 12. 8 x 8 PCR Strip	66
7. 12. 1. Items Supplied	66
7. 12. 2. Technical Data	66
7. 12. 3. Rotor Performance Data.....	66
7. 12. 4. Accessories.....	67
7. 12. 5. Biocontainment Certificate.....	67
7. 13. 8 x 50 mL Individually Sealed	68
7. 13. 1. Items Supplied	68
7. 13. 2. Technical Data	68
7. 13. 3. Rotor Performance Data.....	68
7. 13. 4. Accessories.....	69
7. 13. 5. Biocontainment Certificate.....	69
7. 14. Hematocrit Rotor	69
<hr/>	
8. Chemical Compatibility	70

Preface

Before starting to use the centrifuge, read through these instructions for use carefully and follow the instructions.

The information contained in these instructions for use is the property of Thermo Fisher Scientific; it is prohibited to copy or pass on this information without explicit approval in writing by its owner.

Failure to follow the instructions and safety information in these instructions for use will result in the expiration of the seller's warranty.

Intended Use

The centrifuge is intended for the separation of liquid human specimens, such as blood or urine, collected in IVD specimen receptacles.

The centrifuge is used in in-vitro diagnostic processes to support the collection of information regarding diseases and other physiological or pathological states, such as immunological or hematological screening (e.g. measurement of free hemoglobin).













The semi-automated centrifuge is intended to be used in medical laboratories by trained personal.

Signal Words and Symbols

Signal Word	Degree of Hazard
WARNING	Indicates a hazardous situation that, if not avoided, could result in death or serious injury.
CAUTION	Indicates a hazardous situation that, if not avoided, could result in minor or moderate injury.
NOTICE	Indicates information considered important, but not hazard-related.









Symbols used on Centrifuge and Accessories

Observe the information contained in this instruction manual to keep yourself and your environment safe.

	General hazard		Danger of cuts
	Biological hazard		Hazard caused by hot surface.
	Refer to instruction manual		Disconnect mains plug
	In vitro diagnostic medical device		Manufacturer
	Batch code		This Symbol demands to check, if the rotor is installed correct by lifting it slightly at the handle.a
	Conformity to Chinese environmental law.		Indicates conformity with Underwriter Laboratories (UL) requirements.

Symbols used in the Instruction Manual

Observe the information contained in the instruction manual to keep yourself and your environment safe.

	General hazard		Electrical hazard
	Biological hazard		Danger of cuts
	Hazard caused by flammable materials		Risk of crushing
	Hazard caused by hot surface.		Indicates information considered important, but not hazard-related.
[→ 29]	This is a cross reference. The arrow stands for “refer to” or “see”. The symbol in the middle stands for “page”. The page number is stated at the end. In this example it is page 33. Page numbers are placed at each bottom of a page.		

Safety Instructions



WARNING

Observe the safety instructions. Not following these instructions can cause damage like harm by mechanical impact, electrical shock, infection and loss of sample.

The centrifuge is to be used for its intended use only. Improper use can cause damages, contamination, and injuries with fatal consequences.

The centrifuge must be operated by trained personnel only.

It is the obligation of the operator to make sure, that the proper protective clothing is used. Mind the “Laboratory Biosafety Manual” of the World Health Organization (WHO) and the regulations in your country.

As safety zone maintain a clear radius of at least 30 cm around the centrifuge. Do not place any dangerous substances within this safety zone.

Set up in a well-ventilated environment, on a horizontally leveled and rigid surface with adequate load-bearing capacity.

Do not modify the centrifuge and its accessories in any unauthorized way.

The centrifuge housing is not to be opened by the operator.



WARNING

Risk of damage due to incorrect power supply.

Make sure that the centrifuge is plugged only into a power outlet that has been properly grounded.

Do not use a power supply cable with inadequate rating.



WARNING

Risk from handling hazardous substances.

Especially when working with corrosive samples (salt solutions, acids, bases), the accessories and the centrifuge have to be cleaned thoroughly.

Do not centrifuge explosive or flammable materials or substances.

Extreme care should be taken with highly corrosive substances that can cause damage and impair the mechanical stability of the rotor. These should only be centrifuged in fully sealed tubes.

The centrifuge is neither inert nor protected against explosion. Never use the centrifuge in an explosion-prone environment.

Do not centrifuge toxic or radioactive materials or any pathogenic micro-organisms without suitable safety precautions.

When centrifuging any hazardous materials mind the "Laboratory Biosafety Manual" of the World Health Organization (WHO) and any local regulations. When centrifuging microbiological samples from the Risk Group II (according to the "Laboratory Biosafety Manual" of the World Health Organization (WHO)), aerosol-tight biological seals have to be used. Visit the Internet page of the World Health Organization (www.who.int) for the "Laboratory Biosafety Manual". For materials in a higher risk group, extra safety measures must be taken.

If toxins or pathogenic substances have contaminated the centrifuge or its parts, appropriate disinfection measures have to be taken. [→ 29]

If a hazardous situation occurs, turn off the power supply to the centrifuge and leave the area immediately.

Make sure to use the proper accessories for your applications to avoid hazardous contamination.

In any case of severe mechanical failure, such as rotor or bottle crash, personnel should be aware that the centrifuge is not aerosol-tight. Leave the room immediately.

Contact the customer service. Aerosols need time to settle before opening the centrifuge after a crash. Ventilated centrifuges bear a higher risk of being contaminated after a crash than refrigerated centrifuges.



WARNING

Risk of contamination.

Potential contaminations will not remain in the centrifuge while the device is operated.

Take appropriate protection measures to prevent spread of contaminations.

A centrifuge is no system for containment.



WARNING

Serious injuries can occur if you touch a spinning rotor with your hands or tools.

Never open the centrifuge door until the rotor has come to a complete stop and this has been confirmed on the user interface.

The emergency door release may be used in emergencies only to recover the samples from the centrifuge, e.g. during a power failure. [→ 32]

Do not open the centrifuge, while it is running.

In any case of severe mechanical failure, such as rotor or bucket crash, the centrifuge is not aerosol-tight.

In case of rotor failure the centrifuge can be damaged. Leave the room. Inform customer service.



WARNING

Risk of injuries from defective lid spring

Make sure that the centrifuge lid can be opened completely and that it will stay in its position.

Regularly check the lid springs for their proper function.

Do not operate the centrifuge with a defective lid spring.

Let an authorized service technician replace defective lid springs.

**WARNING****The magnets built into the rotors can have a negative effect on active implants, such as cardiac pacemakers.**

The magnets are mounted on the bottom of the rotor.

Always keep a distance of 20 cm between the rotor and the active implant, as the product generates permanent magnetic fields. The magnetic field strength at a distance of 20 cm is less than 0.1 mT, so there should be no interference.

**CAUTION****Safety can be impaired by wrong loading and worn accessories.**

Use only a properly installed rotor. [→ 15]

Do not use rotors, buckets or components which show any signs of removed protective coating, corrosion or cracks. Contact customer service for further advice or inspections.

Use only with rotors which have been loaded properly.

Never overload the rotor.

Always balance the samples.

Use only rotors and components for this centrifuge which have been approved by Thermo Fisher Scientific. Exceptions to this rule are commercially available glass or plastic centrifuge lab ware, provided they have been designed to fit the rotor or the adapter cavities and are approved for the speed or the RCF value of the rotor.

Make sure the rotor is locked properly into place before operating the centrifuge.

**CAUTION****Physical harm caused by ignoring operative basics.**

Never use the centrifuge if parts of its casing are damaged or missing.

Never start the centrifuge when the centrifuge door is open.

Do not move the centrifuge while it is running.

Do not lean on the centrifuge.

Do not place anything on top of the centrifuge during a run.

Implement measures which ensure that no one can approach the centrifuge for longer than absolutely necessary while it is running.

**CAUTION****Due to air friction sample integrity may be affected.**

The temperature of the rotor may rise significantly while the centrifuge is spinning.

Ventilated units lead to a heat up of the rotor above the ambient temperature.

Refrigerated units can have a deviation from displayed and set temperature to the sample temperature.

Make sure the centrifuge temperature control capabilities meet your application specification. If necessary make a test run.

**NOTICE****To shut down the centrifuge:**

Press the STOP key to shut down the centrifuge.

Turn off the centrifuge at the power supply switch. The power supply plug must be freely accessible at all times.

Pull out the power supply plug or disconnect the power supply in an emergency.

1. Transport and Set Up

The shipping box should be inspected upon delivery. When received, carefully examine for any shipping damage before unpacking. If damage is discovered, the delivering carrier should specify and sign for the damage on your copy of the delivery receipt.

Open the box carefully making certain that all parts are accounted for before packaging materials are discarded. [→ ⓘ 10]
After unpacking, if damage is found, report it to the carrier and request a damage inspection.

Important: Failure to request an inspection of damage within a few days after receipt of shipment absolves the carrier from any liability for damage. You must call for a damage inspection.

NOTICE

It is your responsibility to make sure that the centrifuge is set up properly.

1.1. Unpacking

Use the packing list when unpacking to verify that the complete unit has been received. Do not discard packing materials until all is accounted for.

Items Supplied

Item	Quantity
Centrifuge	1
Power Supply Cable	1
Manuals print en	1
Manuals on USB	1

If any items are missing, contact Thermo Fisher Scientific.

1.2. Location

Operate the centrifuge only indoors.

The set up location must meet these requirements:

- Keep a safety zone of minimum 30 cm around the centrifuge. [→ ⓘ 11]

Persons and hazardous substances must be kept out of this safety zone while centrifuging.

Centrifuges cause vibrations. Do not store sensitive devices or dangerous objects or substances in the safety zone.

WARNING Risk of impact. The centrifuge can crush objects and persons in a radius of 30 cm while spinning. Keep a safety zone of 30 cm around the centrifuge for safe operation. Make sure that no one is in the safety zone while the centrifuge is spinning.

- The supporting structure must meet these requirements:
 - » Be stable, solid, rigid and free of resonance.
 - » Be free from grease and dust.
 - » Be applicable for horizontal set up of the centrifuge.
 - It is not allowed to put anything under the centrifuge to compensate for an uneven surface.
 - Do not operate the centrifuge on carts or stand-alone shelving that could move during operation or are inadequately sized for the centrifuge.
 - » Be able to hold the weight of the centrifuge.
- The centrifuge is not equipped with any means for leveling. The supporting structure must be suitably level to allow proper set up.

CAUTION If you do not level the centrifuge, the centrifuge can crash because of imbalance. If you move the centrifuge, you must level it again. Do not move the centrifuge with a rotor attached to the drive shaft because damage can occur to the drive. Do not put anything below the centrifuge feet to level the centrifuge.

- Do not expose the centrifuge, accessories and samples to heat and strong sunlight.

CAUTION UV rays reduce the stability of plastics. Do not subject the centrifuge, rotors and plastic accessories to direct sunlight.

- The set up location must be well ventilated at all times.
- The main switch and power supply plug must be easily accessible at all times. The grounded electrical socket should be well accessible and located outside of the safety zone.
- Do not use this device in close proximity to sources of strong electromagnetic radiation (e.g. unshielded intentional RF sources), as these can interfere with the proper operation. Before operating the device, make sure that the location is suitable with regard to possible electromagnetic radiation.

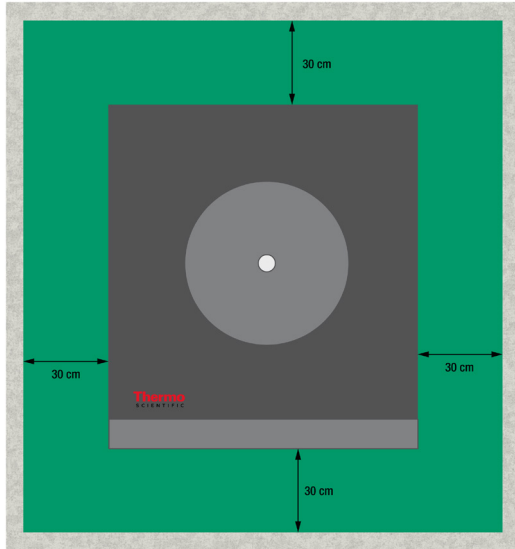

Figure 1: Safety Zone

1. 3. Transporting

Before transporting a centrifuge make sure that

- the power supply cable is unplugged and removed from the centrifuge.
- the rotor is removed.

CAUTION Damage to centrifuge or drive shaft due to movement of an installed rotor. Always remove the rotor before you transport the centrifuge.

- the centrifuge door is closed.

CAUTION Hands can be squeezed by an open centrifuge door. Always close the centrifuge door before you transport the centrifuge.

Before transporting a rotor make sure that

- all components, like adapters and buckets are removed to prevent dropping damage.

Handling Benchtop Centrifuges

- the centrifuge is lifted at both sides and not at the front or back.

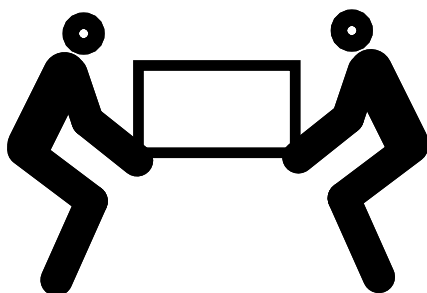
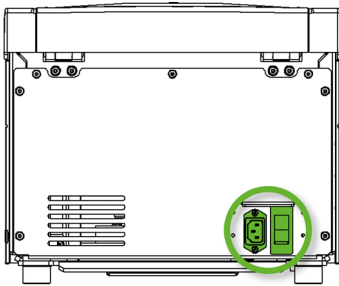

Figure 2: Lifting the Centrifuge at Both Sides

WARNING Always lift the centrifuge on both sides. Never lift the centrifuge by its front or back. The centrifuge is heavy. [→ 35] Assign a minimum of 4 persons to lift and carry a refrigerated centrifuge. Assign a minimum of 2 persons to lift and carry a ventilated centrifuge.

1. 4. Mains Connection



SL 8

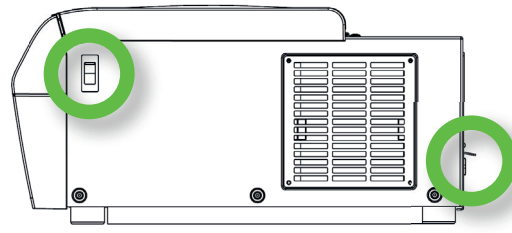

SL 8R

Figure 3: Mains Connection and Power Supply Switch

The centrifuge requires a power source that meets its specifications. Power supply cables are supplied.

WARNING Damage from wrong mains supply or power supply plug. Make sure that the centrifuge is plugged only into sockets which have been properly grounded. Do not operate the centrifuge with a damaged or an inadequately rated power supply cable.

NOTICE Electromagnetic radiation may cause interference on the display. This will not damage, restrict the function of or alter the device. To avoid interference from electromagnetic radiation, do not bring mobile devices, such as cell phones, into the direct vicinity of the device. Do not operate the device with other devices of high electrical power on a common circuit. Do not operate multiple devices on a common power strip.

To connect the centrifuge to the power supply follow this procedure:

1. Turn off the power supply switch located on the right side.
2. Make sure that the cable specification agrees with the safety standards of your country.
3. Make sure that the voltage and frequency are the same as the figures on the rating plate.

The mains plug must be freely accessible at all times.

Disconnect the centrifuge from the power source when not in use.

2. Operation

2.1. Control Panel

The control panel contains the keys and displays of the centrifuge (only the power switch is located on the right side (refrigerated model) or on the backside (ventilated model) of the device).

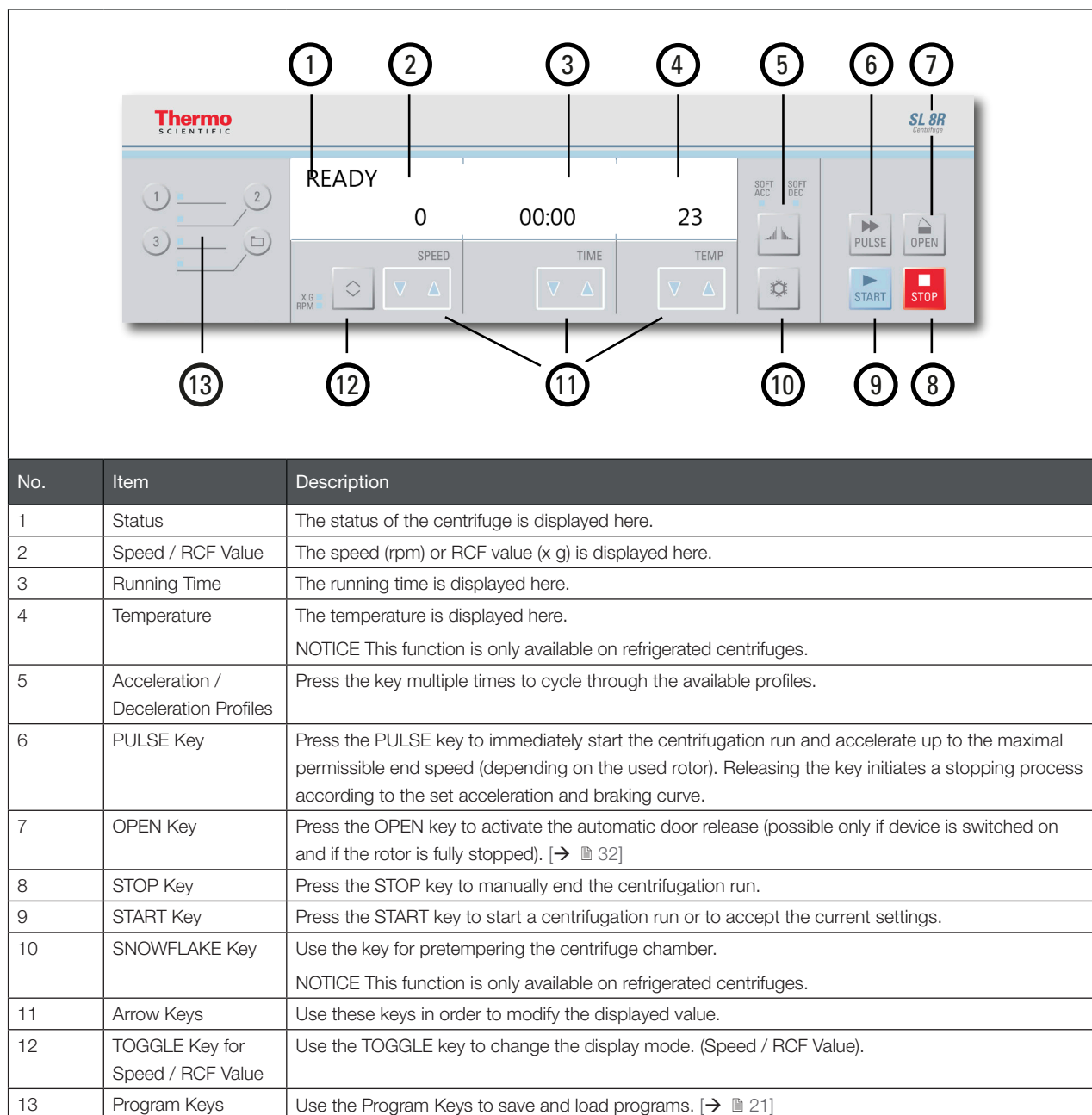

Figure 4: Control Panel Overview

2. 2. Power on / off the Centrifuge

NOTICE Only display pictures of a refrigerated centrifuge are shown. The display of a ventilated centrifuge only misses the details for temperature.

2. 2. 1. To power on the centrifuge

Push on the mains switch of the centrifuge to “1” to power it on.

The device performs a self-check of its software.

- a. When the centrifuge door is closed the display shows:

READY		
0	00:00	23

The speed and time displays read “0” and “00:00”; the current temperature inside the rotor chamber is displayed.

- b. When the centrifuge door is open the display shows:

DOOR OPEN		
8000	HOLD	10

The speed and time displays show the pre-set values ; the set temperature inside the rotor chamber is displayed.

2. 2. 2. To power off the centrifuge

Set the mains switch of the centrifuge to “0” to power it off.

2. 3. Open / Close the Centrifuge Door

2. 3. 1. To open the centrifuge door

Press the **Open** button on the control panel.

If an error occurs, i.e. during a power failure, it is possible to open the centrifuge door using the mechanical emergency lid lock. [→  32]

[Supplementary Information](#)

CAUTION Open the centrifuge only when the rotor stopped spinning. The display shows the current speed also during a failure.

Never reach into the centrifugation chamber while the rotor is spinning.

CAUTION Injuries may occur from a declining centrifuge door gas spring. If the pressure of the centrifuge door gas spring is not sufficient the centrifuge door will not stay open and can fall down. Pay attention on the functionality of the centrifuge door gas spring.

NOTICE The centrifuge door can only be opened when the centrifuge is switched on.

2. 3. 2. To close the centrifuge door

Ensure that the centrifuge platform is clear from objects.

Keep hands and objects well clear of the underside and side of the centrifuge door when closing.

Close the centrifuge door by pressing down on it lightly in the middle or on both sides of it. The centrifuge door mechanism will click and lock in place. Lids should not be slammed as excessive force may cause damage or disrupt samples.

[Supplementary Information](#)

WARNING Do not use the mechanical emergency door release as regular procedure to open the centrifuge. Use the mechanical emergency door release only if a malfunction or power failure occurs and only when you have made sure that the rotor has stopped spinning. [→  32]

CAUTION Do not reach into the gap between the centrifuge door and the housing.

NOTICE The centrifuge door should audibly click into place.

Centrifuge door gas spring

The functionality of a centrifuge door gas spring declines with the time and frequency of use. Pay attention on the functionality of the centrifuge door gas spring.

How to check the functionality of the centrifuge door gas spring:

1. Open the centrifuge door and check if the centrifuge door stays open. The centrifuge door gas spring balances the weight of the centrifuge door and keeps the centrifuge door open. If the centrifuge door does not stay open, contact the customer service.
2. Check, if the centrifuge door gas spring is damaged. If the housing of the centrifuge door gas spring is damaged, contact the customer service.

2. 4. How to Operate a Rotor

Operate the centrifuge only with rotors and accessories from the list with approved rotors. [→  35]

2. 4. 1. How to install a rotor

1. Press the **Open** button control panel to open the centrifuge door.
2. Place the rotor over the drive shaft and let it slide down slowly.
The rotor clicks into place automatically.
3. Make sure that the rotor is properly installed by lifting it slightly on the handle. If the rotor can be pulled up, then it must be reclamped to the drive shaft.
4. Make sure the rotor spins freely by turning it manually.
5. Swinging bucket rotors only: make sure that a full complement of buckets is installed before operating the rotor.
6. Rotor lid installation:

Put the rotor lid on the rotor. Make sure the rotor lid is put centered on the rotor.

- » Rotor lids with knob: Turn the rotor knob clockwise to close the rotor. Turn it counter-clockwise to open rotor.

There is no need to press the Auto-Lock key to close or open the rotor.

- » Rotor lids with Thermo Scientific ClickSeal™: the rotor lid locks with an audible click when put and locked onto the rotor. Press the ClickSeal button to unlock the rotor lid.

Before installing a rotor

- Remove any dust, foreign objects or residue from the chamber, if necessary.
- Wipe the drive shaft and the rotor hub from the bottom side of the rotor with a clean cloth.
- Inspect the Auto-Lock and O-ring; both must be clean and undamaged. [→  16]

CAUTION Do not install the rotor when the temperature difference between the shaft and the rotor lock is >20 °C. Otherwise the rotor might jam.

2. 4. 2. How to remove a rotor

1. Press the **Open** button on the control panel to open the centrifuge door.
2. Remove samples, adapters or buckets.
3. Grasp the rotor handle.
4. Press the Auto-Lock key and, at the same time, pull the rotor directly upwards and away from the drive shaft. Make sure you do not tilt the rotor while lifting it.

Supplementary Information

WARNING If the rotor cannot be properly locked in place after several attempts, then the Auto-Lock is defective and you are not permitted to operate the rotor. Check for any damage to the rotor: Damaged rotors must not be used. Keep the drive shaft area of the rotor clear of objects.

CAUTION Risk of burning on hot surfaces. When installing or removing a rotor you may accidentally touch the spindle or motor surface. The centrifuge spindle and the motor may be hot (>55 °C). Be aware of this risk and proceed carefully when you change a rotor after a run or wait until the motor has cooled down.

CAUTION Do not force the rotor onto the drive shaft. If the rotor is very light, it may be necessary to carefully press it onto the drive shaft with little force.

CAUTION Make sure that the rotor is properly locked on the drive shaft before each use by pulling at its handle.

CAUTION Unapproved or incorrectly combined rotors and accessories can cause serious damage to the centrifuge.

Use only approved rotors listed in this manual. Operate the centrifuge only with rotors and accessories from this list. [→ ⓘ 35] Make sure that all components of a rotor are safely fixed when carried.

The centrifuge is equipped with a Thermo Scientific™ Auto-Lock™ locking feature that automatically locks the rotor to the drive shaft.

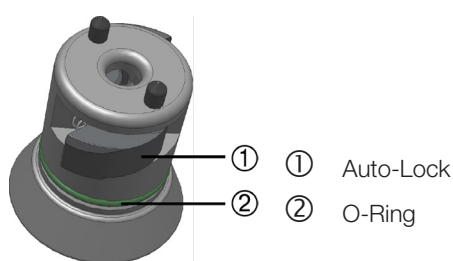

Figure 5: Auto-Lock on the drive shaft

Aerosol-tight Rotors

When using an aerosol tight lid the rotor can be removed with the lid closed. This is to protect you and the samples.

NOTICE Make sure that all components are safely fixed before you carry a rotor.

2. 5. Load the Rotor

2. 5. 1. Balance Loading

Load the compartments evenly. Balance opposite loads.

When using swinging bucket rotors mind the following in addition:

- Weigh the bucket content (adapter and tube). Make sure you do not exceed the maximum compartment load nor the weight difference limit for adjacent buckets if there is one for the rotor.
- Make sure to install all buckets if using swinging bucket rotors.
- Make sure you install an identical bucket type in opposite positions.

If in doubt, contact Thermo Fisher Scientific customer service.

Correct Loading ✓

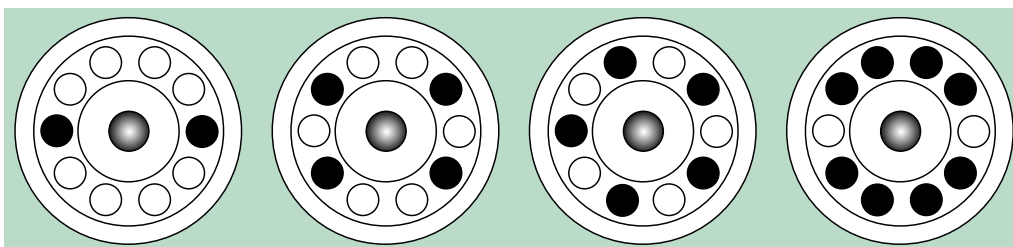

Figure 6: Correct loading examples for fixed angle rotors

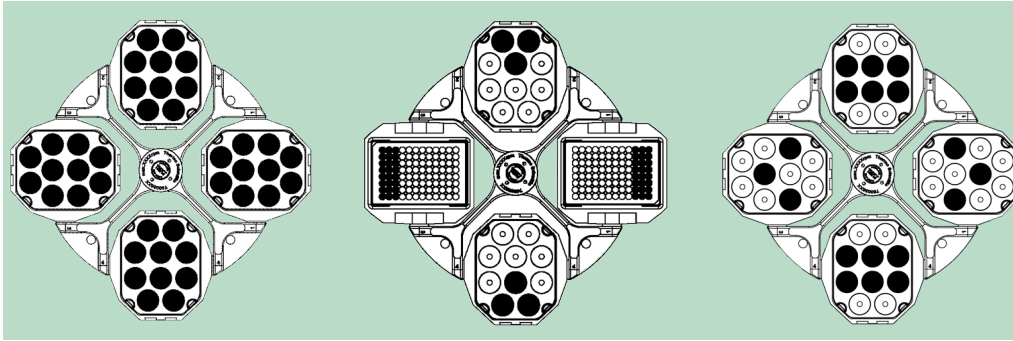

Figure 7: Correct loading examples for swinging bucket rotors

Incorrect Loading ✗

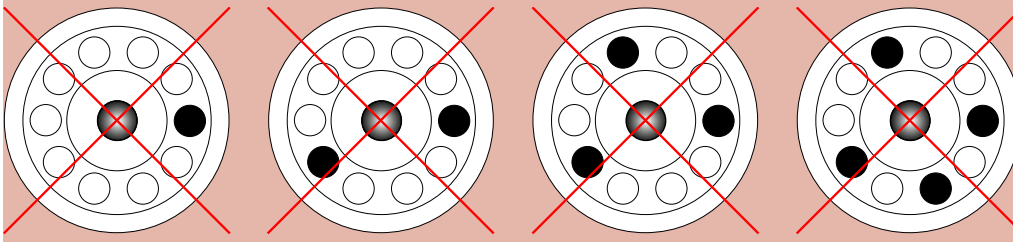

Figure 8: Incorrect loading examples for fixed angle rotors

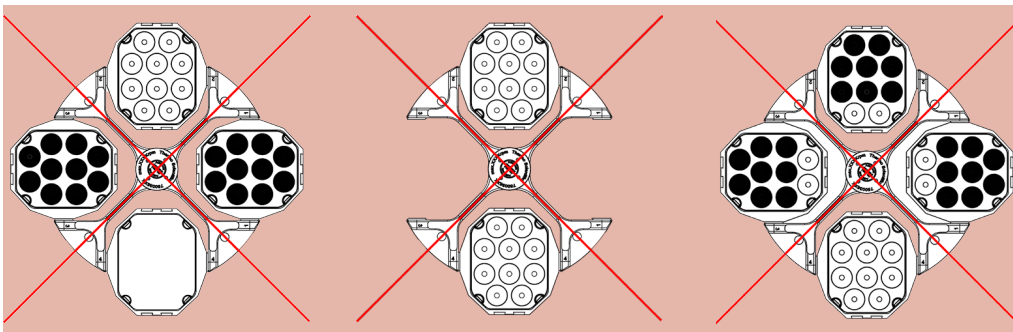

Figure 9: Incorrect loading examples for swinging bucket rotors

Before Loading a Rotor

Before loading a Rotor

1. Inspect the rotor and all accessory parts for damage, such as cracks, scratches, or traces of corrosion.
2. Inspect the centrifugation chamber, drive shaft and Auto-Lock device for damage, such as cracks, scratches, or traces of corrosion.
3. Check the suitability of the rotor and other used accessories against the Chemical Compatibility Chart. [→ 70]
4. Make sure that:
 - » tubes or bottles fit in the rotor.
 - » the tubes or bottles do not touch the rotor lid or bucket caps.
 - » buckets or microplate carrier can swing freely by moving them carefully with your hand.



CAUTION

Incorrect loading can lead to damage. Always load the rotor symmetrically to avoid imbalance, noisy spinning and possible damage. A full complement of buckets needs to be installed before operating a swinging bucket rotor.



CAUTION

When using an aerosol-tight rotor lid or bucket caps, verify that the sample tubes don't interfere with the rotor lid or bucket cap and don't compromise its sealing efficiency.

**CAUTION**

Always use identical bucket types in opposite positions. Make sure that opposite buckets are of the same weight class, if a weight class is labeled on the buckets.

**CAUTION**

Tubes may open and break during centrifugation because they do not fit properly to the cavities.

Contamination may occur.

Make sure that the length and width of the tubes are fitting into the adapter and cavities. Do not use tubes that are too short or too thick for the adapter and the cavities.

Maximum Loading

Each rotor is designed to run with its maximum load at maximum speed. The safety system of the centrifuge requires that the rotor is not overloaded.

The rotors are designed to work with substance mixtures with a density of up to 1.2 g/ml. If the admissible maximum load is exceeded, the following steps need to be taken:

- Reduce the fill level.
- Reduce the speed.

Use the following formula to calculate the maximum admissible speed for a given load:

$$n_{\text{adm}} = n_{\text{max}} \sqrt{\frac{w_{\text{max}}}{w_{\text{app}}}}$$

n_{adm} = admissible maximum application speed

n_{max} = maximum rated speed

w_{max} = maximum rated load

w_{app} = applied load

RCF Value Explained

The relative centrifugal force (RCF) is given as a multiple of the force of gravity (g). It is a unitless numerical value which is used to compare the separation or sedimentation capacity of various centrifuges, since it is independent of the type of device. Only the centrifuging radius and the speed are used for calculation:

$$\text{RCF} = 11,18 \times \left\langle \frac{n}{1000} \right\rangle^2 \times r$$

r = centrifuging radius in cm

n = rotational speed in rpm

The maximum RCF value is related to the maximum radius of the tube opening.

Remember that this value is reduced depending on the tubes, buckets and adapters used.

This can be accounted for in the calculation above if required.

Use of Tubes and Consumables

Make sure that the tubes and bottles used in the centrifuge are:

- rated to or above the selected RCF to be spun at,
- never used below their minimum fill volume and never above their maximum fill volume,
- not used above their design life (age or number of runs),
- undamaged,
- fitting well into the cavities.

Please refer to manufacturers' data sheets for further information.

2. 6. Entering Centrifugation Parameters

2. 6. 1. Acceleration / Deceleration Profiles

The centrifuge offers you 2 profiles: standard and soft. The setting is displayed above the Acceleration / Deceleration Profiles key.

Press the Acceleration / Deceleration Profiles key to cycle through and set the available profiles.

The LEDs show the chosen settings. The last selected profile is saved and will be restored after a restart of the centrifuge.

LED Light Settings	Description
OFF	Acceleration and Deceleration with max. power = Standard
SOFT ACC	Acceleration = Soft
SOFT DEC	Deceleration = Soft
SOFT ACC and SOFT DEC	Acceleration and Deceleration = Soft

Figure 10: Acceleration / Deceleration Profiles

NOTICE In case of an error the deceleration profile can be set off to prevent damage.

2. 6. 2. Selecting Speed / RCF

RPM stands for Revolutions Per Minute.

RCF stands for Relative Centrifugal Force and allows better transfer of protocols between centrifuges and rotors of differing size.

Ensure that the rpm or RCF is correctly set.

1. Press the **TOGGLE** key below the SPEED display to cycle through the RPM / RCF selection.

The LED light will indicate if “RPM“ or “RCF” is selected.

RPM / RCF can be viewed during a run by pressing the toggle button.

2. Enter the desired value by holding the arrow keys below SPEED in the corresponding direction, until the desired value shows. First RPM / RCF will change in steps of 10. Holding a key pressed will change the speed then in steps of 100 and then in steps of 1000.

Press the START key to accept or wait 4 seconds until the centrifuge automatically saves the chosen values. Moving to setting time or temperature also automatically stores the set value.

NOTICE The minimum motor speed is 300 rpm. Any extremely low RCF settings will be automatically increased to the minimum rcf at 300 rpm.

2. 6. 3. Setting the Running Time

1. Press the **TIME** arrow keys. This allows to change the set time using the arrow keys until the desired time is displayed.

First runtime will change in steps of 10 second. Holding a key pressed will change the runtime by steps of single minutes, followed by steps of 10 minutes, followed by steps of single hours and at least by steps of 10 hours. This will continue until the limit of 99 hours and 59 minutes is reached.

Enter the desired runtime in hh:mm or mm:ss.



2. Press the START key to accept or wait 4 seconds until the centrifuge automatically saves the chosen values. Moving to setting speed / RCF or temperature also automatically stores the set value.

NOTICE Avoid if possible speed ranges close to natural resonances of the system. Runs at resonance speeds may cause vibration and have an adverse effect on the quality of separation.

2. 6. 4. Continuous Operation

1. Press either **ARROW** keys until HOLD is displayed.
2. Press the **START** key to accept or wait 4 seconds until the centrifuge automatically saves the chosen values. During continuous operation, the centrifuge will continue running until you stop it manually.

2. 6. 5. Selecting the Temperature

You can select temperatures between -10 °C and +40 °C.

To set the temperature, proceed as follows:

Press the **TEMPERATURE** arrow keys. This allows to change the set temperature using the arrow keys until the desired temperature is displayed. Temperature will change in steps of single degrees Celsius.

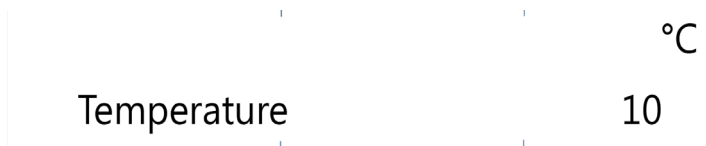

2. 6. 6. Prewarming or Precooling the Centrifuge

Ensure the rotor, buckets and accessories are correctly in place and securely attached in the chamber. For setting the pretemp value for the centrifuge proceed as follows:

1. Press the **SNOWFLAKE** key in order to open the temperature selection menu.
The display shows the message "Pre-Temp".
2. Enter the desired value by pressing the TEMP arrow keys, until the desired value shows.

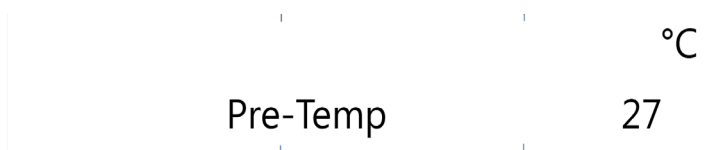

3. Press the **START** key.

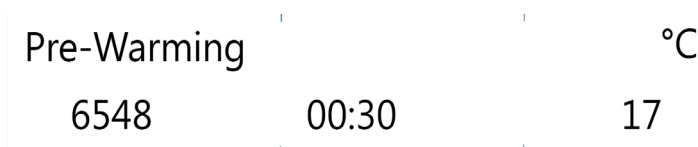

4. The centrifuge motor will run at a specific speed defined by the rotor. This improves air circulation within the centrifugation chamber, resulting in improved temperature control throughout the centrifugation chamber and rotor. According to the set values the air within the centrifugation chamber is heated or cooled to the preset temperature.
5. When the set temperature is reached, the centrifuge will beep and continue to hold the temperature.

Press the **STOP** key to end the prewarming or precooling.

The display shows the current temperature inside the centrifugation chamber.

2. 7. Programs

The centrifuge is able to save up to 99 programs. It is only possible to save a program if the centrifuge is in standstill. Loading or saving of programs is not possible if a rotor is spinning.

2. 7. 1. Saving a Program

Modify the speed, time and temperature to the desired setting.

[For Direct Access Programs 1, 2, 3](#)

Press and hold the desired program key 1,2 or 3 for 4 seconds.

[For Programs 4-99](#)

1. Press the folder key for 4 seconds. Use the SPEED arrow keys, to scroll through until the desired number is selected.
2. Press the **START** key to confirm.
3. The program can now be named using up to 12 alphanumeric characters. Use the SPEED arrow keys to scroll through the characters. Use the TIME arrow keys to move left or right.
4. Press the **START** key to confirm and save the program or wait 10 sec until the program is saved automatically.

To abort at any point press the **STOP** key.

2. 7. 2. Loading a Program

[For Direct Access Programs 1, 2, 3](#)

Press one of the direct access program keys 1, 2, 3.

[For Programs 4-99](#)

Press the folder key. Use the SPEED arrow keys to scroll through until the desired program is selected.

2. 7. 3. Programs Only Mode

When using the Programs Only mode it is only possible to load programs, start and stop centrifugation runs and open the centrifuge door. Any other functions are deactivated.

To use the Programs Only mode it needs to be activated within the user menu. [→ ⓘ 26]

2. 8. Centrifugation



WARNING

Damage to health from centrifuging explosive or flammable materials or substances. Do not centrifuge explosive or flammable materials or substances.



CAUTION

Due to air friction sample integrity may be affected.

The temperature of the rotor may rise significantly while the centrifuge is spinning. Ventilated units lead to a heat up of the rotor above the ambient temperature. Refrigerated units can have a deviation from displayed and set temperature to the sample temperature. Make sure the centrifuge temperature control capabilities meet your application specification. If necessary make a test run.

Mind the safety zone of minimum 30 cm around the centrifuge. [→ ⓘ 11] Persons and hazardous substances must be kept out of this safety zone while centrifuging.

Once the main switch has been turned on, the rotor has been properly installed, the setpoints have been set as explained in the previous section, and the centrifuge door has been closed, you are ready to start.

Starting Centrifugation

Press **START** on the control panel. The centrifuge accelerates to the preset speed with the time display active. If no action is taken, the centrifuge will decelerate until stop, then the centrifuge door should be opened and the rotor checked.

If the speed setting is higher than the maximum permissible speed or RCF-value for the particular rotor, then after starting the display will show the message “Limit” – followed by the maximum RPM or RCF-value of the inserted rotor once the centrifuge has been started. Within 10 seconds of the message it is possible to accept the highest RPM / RCF of the inserted rotor by pressing **START**. The centrifuge will then continue run for the set time and at the set temperature. If no action is taken within 10 seconds, the centrifuge will decelerate until the rotor is stopped. The speed will be automatically set to the maximum speed of the installed rotor. The message can only be reset by opening the centrifuge door.

Imbalance Indicator

The centrifuge is fitted with an imbalance detector, to ensure safety. If an imbalance is detected an error message “Imbalance load” will be displayed.

Imbalance at high speed may indicate a tube breakage or leak or rotor crash. Therefore additional care should be taken depending on the samples loaded.

The run will terminate.

Once the run is stopped, the rotor and load should be checked, ensuring that all buckets are greased and can swing free and that the tubes are balanced by following the rotor instruction manual.

For information on troubleshooting: [→ ⓘ 32]

Stopping Centrifugation

With Set Time

If the run time is preset, the centrifuge will run at the selected speed until the desired run time is reached. It will then automatically decelerate and stop. Once stopped “RUN COMPLETED” will be displayed and if selected the display will flash and the centrifuge will beep.

Access to the chamber and rotor can be gained by pressing the **OPEN** key. If selected the door will open automatically.

You can also stop the centrifuging program manually at any time by pressing the **STOP** key. The message “RUN STOPPED BY USER” will be displayed.

Continuous Operation

If you selected continuous operation, you will have to stop the centrifugation manually. Press the **STOP** key on the control panel. [→ ⓘ 20]

The centrifuge will decelerated at the set rate. The message “RUN COMPLETED” will be displayed.

After pressing the **OPEN** key, the centrifuge door will open and you can remove the centrifuged samples.

2. 9. Short-term Centrifugation

For short-term centrifuging, the centrifuge has a PULSE function.

When you press and hold **PULSE**, spinning will start and continue until you release the key.

The centrifuge accelerates to and brakes at maximum power. The pre-selected value is ignored.

NOTICE The centrifuge accelerates to maximum speed.

The run time is initially displayed in seconds. After one minute the display changes every minute.

After a short-term centrifugation run the set values are restored.

2. 10. Aerosol-tight Applications

2. 10. 1. Basic Principles

- Make sure that the sample containers are well suited for the desired centrifugation process.
- The temperature in ventilated centrifuges can reach 15 °C above room temperature.



CAUTION

Aerosol-tight rotors and tubes may only be opened in an approved safety workbench when centrifuging dangerous samples. Mind the maximum permissible load.



CAUTION

Prior to each use, the seals in the rotor need to be inspected in order to assure that they are correctly seated and are not worn or damaged. Damaged seals are to be replaced immediately. Replacement seals can be re-ordered as a spare part. [→ 40] When loading the rotor, ensure that the rotor lid closes securely. Damaged rotor covers are to be replaced immediately.

2. 10. 2. Fill Level

Do not fill the tubes beyond a safe level to prevent the sample from reaching the top of the tube during centrifugation. To be on the safe side, fill the tubes only to 2/3 of the rated level.

2. 10. 3. Aerosol-Tight Rotor Lids

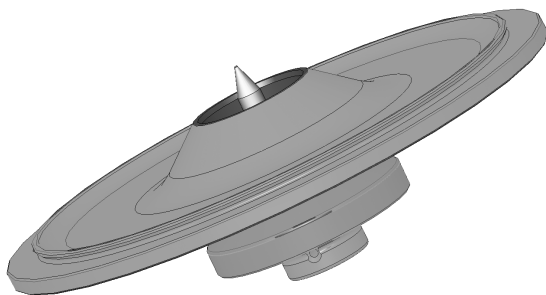

Figure 11: Lid of an aerosol-tight rotor with mandrel

Placing O-Ring

The O-ring fulfills its purpose best, when it is neither stressed nor bulked. Meaning the O-ring should be equally placed in the groove of the lid.

Place the O-ring as follows:

1. Place the O-ring above the groove.
2. Push the O-ring on two opposite places into the groove. Make sure the rest of the O-ring is equally distributed.
3. Push the mids of the loose parts into the groove.
4. Push the remaining O-ring into place.

NOTICE If the O-Ring seems to be too long or too short, take it off the lid and repeat the process.



CAUTION

When using an aerosol-tight rotor lid, verify that the sample tubes do not interfere with the rotor lid and compromise its sealing efficiency.



CAUTION

Rotors supplied with a lid for aerosol-tight applications come with a mandrel as an accessory to the Auto-Lock device. Be sure not to place the lid on this mandrel. The lid may be damaged.

2. 10. 4. Aerosol-Tight Rotor Buckets

Aerosol-tight Closure with ClickSeal

1. If necessary, grease the lid joint before closing the lid. Use rubber seal grease (76003500) for this.
2. Raise the latch.
The cap can now be easily placed on the bucket.
3. Lower the latch to close the bucket aerosol-tight; be sure the latch clicks into place.
Make sure that both sides of the latch are closing the bucket cap.

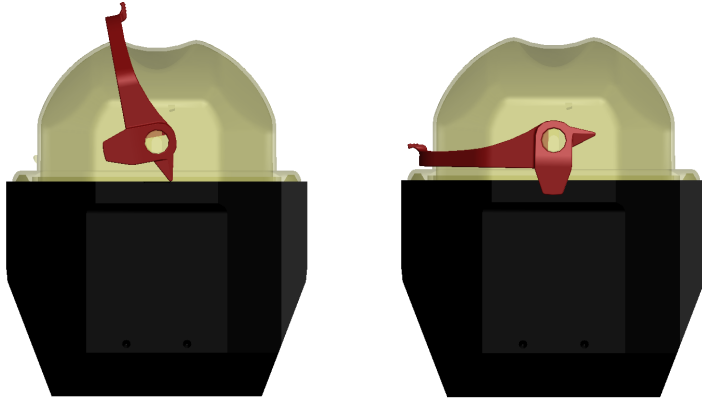

Figure 12: Bucket with open lid (left) and closed lid (right)



CAUTION

If the latch is not flipped down, the caps could be damaged during centrifugation. If the latch has not clicked into place, the bucket is not aerosol-tight. Never lift the bucket at its latch.



CAUTION

Make sure that the length of tubes used allow proper closing of the bucket cap. Otherwise the bucket will not be aerosol-tight.

2. 10. 5. Checking Aerosol Tightness

The aerosol-tightness testing of the rotors and buckets depends on the microbiological test process in accordance with the EN 61010-2-020 Appendix AA.

Whether or not a rotor is aerosol-tight depends primarily on proper handling.

Make sure that your rotor is aerosol-tight.

The careful inspection of the seals and seal surfaces for signs of wear and damage such as cracks, scratches and embrittlement is extremely important.

Aerosol-tight applications are not possible if the rotor is run without the lid.

Aerosol-tightness requires the correct operation when filling the sample vessels and closing the rotor lid.

Quick Test

As a quick test, it is possible to test the aerosol-tightness using the following process:

1. Lubricate all seals lightly.
Always use the rubber seal grease (76003500) when lubricating the seals.
2. Fill the bucket with approx. 10 ml of carbonated water.
3. Close the bucket as explained in the handling instructions.
4. Shake the bucket vigorously using your hands.

This releases the carbonic acid gas which is bound in the water, resulting in excess pressure. Do not apply pressure to the lid when doing so.

Leaks can be detected by escaping water or the sound of escaping gas.

Replace the seals if you detect any leaks. Then repeat the test.

Dry the rotor, rotor lid and the cover seal.

CAUTION Prior to each use, the seals in the rotor are to be inspected in order to assure that they are correctly seated and are not worn or damaged. Damaged seals are to be replaced immediately. Replacement seals can be re-ordered as a spare part. [→  40] When loading the rotor, ensure that the rotor lid closes securely. Damaged rotor covers are to be replaced immediately.



CAUTION

The quick test is not suited for validating the aerosol tightness of a rotor. Check the seals and sealing surfaces of the lid thoroughly.

3. System Menu

To get into the system menu, press and hold any key on the front panel turning on the centrifuge. Keep this key pressed until “ENTER USER MENU?” appears in the display. Navigate through the system menu using the TIME arrow keys.

Flowchart System Menu

The system menu can be navigated using the SPEED arrow keys. The shown entry can be changed using the TIME and TEMP arrow keys. Press the START key to save this edit and quit the system menu. Press the STOP key to quit the system menu.

Software ID and NVRAM ID information are entries within the user menu.

Values shown at some entries in the picture below are only examples.

NOTICE A total number of cycles completed on the centrifuge is counted, since installation or a new main board was installed. Cycle counts should be periodically recorded to help with the identification of the total number of runs a rotor has completed.

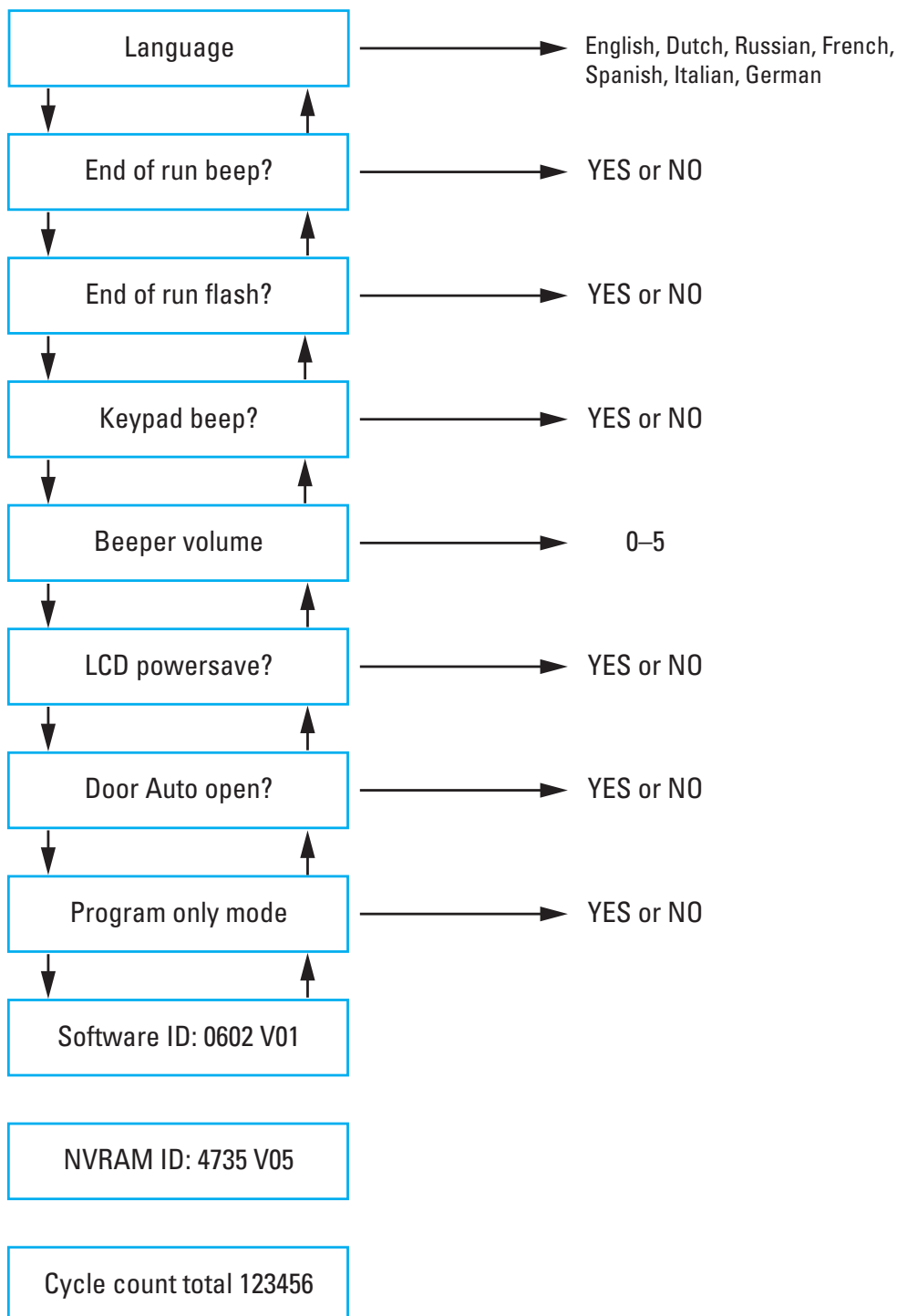

4. Maintenance and Care

4.1. Cleaning Intervals

For the sake of personal, environmental, and material protection, you must clean and if necessary disinfect the centrifuge and its accessories on a regular basis.

4.2. Basics

- Use warm water with a neutral detergent that is suitable for use with the materials. If in doubt contact the manufacturer of the cleaning agent.
- Use a soft cloth for cleaning.
- Never use caustic cleaning agents such as soap suds, phosphoric acid, bleaching solutions or scrubbing powder.
- Remove rotor and clean centrifugation chamber with a small amount of cleaning agent on a clean cloth.
- Use a soft brush without metal bristles to remove stubborn residue.
- Afterwards rinse with a small amount of distilled water and remove any remains with absorbent towels.
- Use only cleaning and disinfecting agents with a pH of 6-8.
- After thoroughly cleaning the rotors, they must be inspected for damage, wear and corrosion.
- Make sure that sealing rings are still smooth, not brittle nor otherwise damaged. Some sealing rings are not autoclavable. Replace brittle or damaged sealing rings immediately. [→ ⓘ 40]



CAUTION

Not rated procedures or agents could deteriorate the materials of the centrifuge and lead to malfunction. Refrain from using any other cleaning or decontamination procedure, if you are not entirely sure that the intended procedure is safe for the equipment. Use only cleaning agents that will not damage the equipment. In doubt contact the manufacturer of the cleaning agent. If still in doubt, contact Thermo Fisher Scientific.



CAUTION

Do not run any rotor or accessories with sign of damage. Ensure that the rotor, buckets and accessories are within their expected maximum number of cycles. It is recommended that you have rotors and accessories inspected yearly as part of your routine service to ensure safety.

4.2.1. Rotor and Accessories Inspection

After thoroughly cleaning the rotors, they must be inspected for damage, wear and corrosion.

The cycle limits of the rotors and buckets are stated on some rotors and buckets and in the technical data section of each rotor. [→ ⓘ 40]

The lifetime of rotors and buckets is dependent on the amount of mechanical load. Do not exceed their number of cycles recommended for rotors and buckets.

NOTICE Usage beyond these limits might lead to rotor failure, sample loss and damage to the centrifuge.



CAUTION

Do not run any rotor or accessories with sign of damage. Ensure that the rotor, buckets and accessories are within their expected maximum number of cycles. It is recommended that you have rotors and accessories inspected yearly as part of your routine service to ensure safety.

Metal Parts

Make sure that the protective coating is complete. It can be removed through wear and chemical attack and can lead to unseen corruptions. In case of corrosion, such as rust or white / metallic pitting, the rotor or accessories must be removed from service immediately. Particular attention should be paid to the bottom of buckets on swinging bucket rotors and tube cavities on fixed angle rotors.

Slide Coated Rotors

Rotor crosses are provided with an anti-friction and corrosion resistant finish.

The following procedure is for rotor crosses and rotor trunnion bolts:

- Regular cleaning of contact area between the rotor and buckets (rotor cross trunnions and bucket grooves) is recommended with a mild detergent (every 300-500 cycles).
- The rotor cross is coated with a special advanced lubricating and protective coating, therefore no grease is necessary.
- Contaminating particles (dirt, dust or debris) in the rotor cross and bucket grooves may lead to imbalance and cleaning will be required.
- The lubricating coating may, over extended periods or under heavy loads, become worn. If this occurs a small amount of greasing of the rotor cross trunnions will be required with bolt grease (75003786).

Plastic Parts

Check for signs of plastic crazing, fading, bruising or cracking. In case of damage the inspected item must be removed from service immediately.

O-Rings

Make sure that O-rings are still smooth, not brittle nor otherwise damaged. Some O-rings are not autoclavable.

Replace brittle or damaged O-rings immediately. [→ ⓘ 40]

4. 2. 2. Cycles of Rotors and Buckets

You have to count the cycles of the rotors and buckets using your own method. The centrifuge can not detect the change or replacement of rotors of the same type or of buckets of the same type.

The lifetime of a rotor and buckets depends on the amount of physical load. Do not use rotors and buckets that exceed the maximum number of cycles.

The maximum number of cycles for rotors and buckets is given in the rotor specifications chapter. [→ ⓘ 40] The maximum number of cycles for buckets is marked on the buckets themselves.

4. 3. Cleaning

Clean as follows:

1. Clean rotor, buckets and accessories outside of the centrifugation chamber.
2. Separate rotor, buckets, lids, tubes and sealing rings to allow thorough cleaning. If installed, remove lids from rotors, buckets and tubes. Do not disassemble accessories using tools or force.
3. Rinse rotor and all accessories with warm water and a neutral detergent that is suitable for use with the materials. If in doubt contact the manufacturer of the cleaning agent. Clean away the grease from the rotor trunnions (pivot point for swinging buckets).
4. Use a soft brush without metal bristles to remove stubborn residue.
5. Rinse rotor and all accessories with distilled water.
6. Place the rotors on a plastic grate with their cavities pointing down, to enable the cavities to fully drain and dry.
7. Dry all of the rotors and accessories after cleaning with a cloth or in a warm air cabinet at a maximum temperature of 50 °C. If drying boxes are used, the temperature must never exceed 50 °C. Higher temperatures could damage the material and shorten the lifetime of the parts.
8. Inspect the rotor and accessories for signs of damages.
9. After cleaning, treat the entire surface of aluminum parts including the cavities with corrosion protection oil (70009824).
Treat the bolts of swinging bucket rotors with bolt grease (75003786) if necessary.



CAUTION

Before using any cleaning methods, users should check with the manufacturer of the cleaning agents that the proposed method will not damage the equipment.



CAUTION

Drive and door lock can be damaged by entering liquids. Do not allow liquids, especially organic solvents, to get on the drive shaft, the drive bearings or the centrifuge door locks. Organic solvents break down the grease in the motor bearing. The drive shaft could lock up.

Cleaning the Filter Mat

It is recommended that you clean the filter mat (50141352) regularly every six weeks. Depending on the environmental conditions it may be necessary to clean it more often.

How to clean the filter mat:

Benchtop Centrifuge

1. Unscrew the ventilation grid placed on the right side of the centrifuge.
2. Remove the ventilation grid.
3. Remove the filter mat.
4. Clean the filter mat by tapping off the dust. The filter mat can be rinsed with water, if needed. Dry the filter mat before using it again.

NOTICE Moisture can damage electronics and lead to additional damages at the centrifuge. Only use dry filter mats.

5. Place the filter mat back on the capacitor.
6. Screw the ventilation grid onto the centrifuge.

4. 4. Disinfection

You are responsible that the level of disinfection is achieved according to your requirements.

After disinfection:

1. Rinse the centrifuge and all affected accessories with water.
2. Allow to fully drain and dry.
3. After disinfecting, treat the entire surface of aluminum parts including the cavities with corrosion protection oil (70009824).

Treat the bolts of swinging bucket rotors with bolt grease (75003786) if necessary.



WARNING

Do not touch infected parts. Hazardous infection is possible when touching the contaminated rotor and centrifuge parts. Infectious material can get into the centrifuge when a tube breaks or as a result of spills. In case of contamination, make sure that no one is put at risk. Disinfect the affected parts immediately.



CAUTION

Equipment can be damaged by inappropriate disinfection methods or agents. Make sure that the disinfection agent or the method will not damage the equipment. In doubt contact the manufacturer of the disinfection agent. Observe the safety precautions and handling instructions for the disinfection agents used.

4. 5. Decontamination

You are responsible that the level of decontamination is achieved according to your requirements.

After decontamination:

1. Rinse the centrifuge and all affected accessories with water.
2. Allow to fully drain and dry.
3. After decontaminating, treat the entire surface of aluminum parts including the cavities with corrosion protection oil (70009824).

Treat the bolts of swinging bucket rotors with bolt grease (75003786) if necessary.



WARNING

Do not touch contaminated parts. Exposure to radiation is possible when touching the contaminated rotor and centrifuge parts. Contaminated material can get into the centrifuge when a tube breaks or as a result of spills. In case of contamination, make sure that no one is put at risk. Decontaminate the affected parts immediately.



CAUTION

Equipment can be damaged by inappropriate decontamination methods or agents. Make sure that the decontamination agent or the method will not damage the equipment. In doubt contact the manufacturer of the decontamination agent. Observe the safety precautions and handling instructions for the decontamination agents used.

4. 6. Autoclaving

As preparation always separate rotor, buckets, lids, tubes and sealing rings to allow thorough cleaning. If installed, remove lids from rotors, buckets and tubes.

If not stated otherwise on the parts themselves, all parts can be autoclaved at 121 °C for 20 min. Only exceptions are the hematocrit rotor at 134 °C and the Microliter 48 x 2 rotor at 138 °C for 20 min. [→ ⓘ 40]

Make sure that the necessary sterility is achieved according to your requirements.

After autoclaving, treat the entire surface of aluminum parts including the cavities with corrosion protection oil (70009824).

Treat the bolts of swinging bucket rotors with bolt grease (75003786) if necessary.



CAUTION

Never exceed the permitted temperature and duration when autoclaving.

NOTICE

No chemical additives are permitted in the steam.

4. 7. Service

Thermo Fisher Scientific recommends having the centrifuge and accessories serviced once a year by an authorized service technician. The service technician checks the following:

- electrical equipment and connections
- suitability of set-up site
- centrifuge lid lock and safety system
- rotor
- fixation of rotor and drive shaft of the centrifuge
- protective casing

Before service, centrifuge and rotors should be thoroughly cleaned and decontaminated to ensure full and safe inspection can be completed.

Thermo Fisher Scientific offers inspection and service contracts for this work. Any necessary repairs are performed for free during the warranty period and afterwards for a charge. That is only valid if the centrifuge has only been maintained by an authorized Thermo Fisher Scientific service technician.

A validation of the centrifuge is recommended and can be ordered from customer service.

4. 8. Lifetime

The centrifuge is specified for a lifetime of 10 years. Decommissioning the centrifuge is suggested when this limit is reached.

The lifetime of rotors is based on cycles and specified individually for each rotor. [→ ⓘ 40] Other accessories are not limited by a specific lifetime and need only be replaced when damaged or worn.

4. 9. Shipping

Before shipping the centrifuge:

- The centrifuge must be clean and decontaminated.
- You must confirm the decontamination with a decontamination certificate.



WARNING

Before shipping the centrifuge and accessories you must clean and, if necessary, disinfect or decontaminate the full system. If you are not sure, consult with Thermo Fisher Scientific customer service.

4. 10. Storage

- Before storing the centrifuge and the accessories it must be clean and if necessary disinfected and decontaminated. Centrifuge, rotors, buckets and accessories have to be fully dry before storage.
- Keep the centrifuge in a clean, dry and dust-free location.
- Do not store the centrifuge in direct sunlight.



WARNING

When you remove the centrifuge and accessories from use, clean and if necessary disinfect or decontaminate the full system. If you are not sure speak to the Thermo Fisher Scientific customer service.

4. 11. Disposal

For the disposal of the centrifuge mind the regulations in your country. Contact the Thermo Fisher Scientific Customer Service for the disposal of the centrifuge. For contact information check the backpage of this manual or visit www.thermofisher.com/centrifuge

For the countries of the European Union the disposal is regulated by the European Union's Waste Electrical & Electronic Equipment (WEEE) Directive 2012/19/EC.

Mind the information on transport and shipping. [→ ⓘ 11] [→ ⓘ 30]



WARNING

When removing the centrifuge and accessories from use for disposal you have to clean and if necessary disinfect or decontaminate the entire system. In doubt contact the Thermo Fisher Scientific customer service.

5. Troubleshooting

5.1. Mechanical Emergency Lid Release

During a power failure, you will not be able to open the centrifuge lid with the regular electric lid release. A mechanical override is provided to allow sample recovery in the case of an emergency. However, this should be used only in emergencies and after the rotor has come to a complete stop.

Always wait until the rotor has come to a stop without braking. The brake does not work when there is no power. The braking process lasts much longer than usual.

Proceed as follows:

1. Wait until the rotor has stopped. This can take several minutes. Use the view port for visual confirmation.
2. Pull out the power supply plug.
3. Pull the release cord.
 - a. SL 8

On the right side of the housing is one white plastic plug which can be removed from the plate with a small flat screwdriver. Once the plug is removed it will expose the release cord.

Pull the release cord attached to it to trigger the mechanical door release. The centrifuge door will open and the samples can be removed.

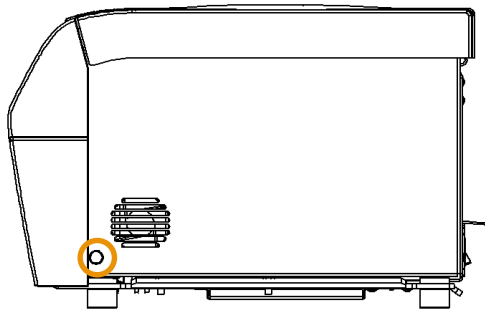

Figure 13: Position of release cord at ventilated benchtop centrifuges

- b. SL 8R

On the bottom of the housing is one white plastic plug which can be removed from the plate with a small flat screwdriver. It is located below the front side of the centrifuge. Once the plug is removed it will expose the release cord.

Pull the release cord attached to it to trigger the mechanical door release. The centrifuge door will open and the samples can be removed.

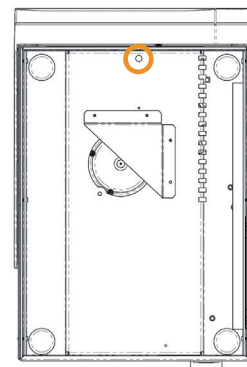
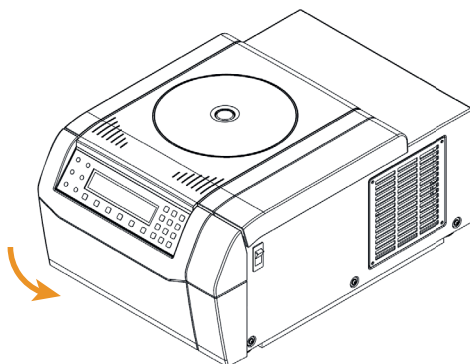



Figure 14: Position of release cord at refrigerated benchtop centrifuges

4. Push the release cord back into the centrifuge and mount the plug.
5. Reconnect the centrifuge once the power has been restored.
6. Switch on the centrifuge. Press the **OPEN** key to have the centrifuge door locks operative again.

 WARNING	<p>Serious injuries can occur if you touch a spinning rotor with your hands or tools. A rotor can still be spinning after a power failure occurs. Do not open the centrifuge before the rotor has stopped spinning. Do not touch a spinning rotor. Never use your hands or tools to stop a spinning rotor.</p>
--	--

5.2. Ice Formation

Warm humid air in combination with a cold centrifugation chamber can lead to formation of ice. To remove the ice from the centrifugation chamber, proceed as follows:



1. Open the centrifuge lid.
2. Remove the rotor. [→  15]
3. Let the ice melt.

NOTICE Do not use any sharp tools, aggressive liquids or fire to fasten the melting process. If necessary use warm water to speed up the melting process.

4. Remove the water from the centrifugation chamber.

5.3. Troubleshooting by Guide

NOTICE	<p>If an error message shows that is not listed in this table, a service technician must be contacted.</p>
---------------	--

Error	Description	Solutions
E-002; E-005; E-008; E-010; E-011; E-012; E-015; E-016; E-034; E-036; E-041; E-048; E-050; E-051; E-052; E-053; E-054; E-072; E-077; E-101; E-104	Read Manual	Restart the centrifuge. If the error message still shows, contact a service technician.
E-031	Temp High!	CAUTION Hot metal parts! Check, if the centrifuge is accessible. Be sure, that the room temperature is within the limits. Let the centrifuge cool down for 15 minutes. Be sure there is no condensed water in the rotor chamber. If the error message still shows, contact a service technician.
E-017; E-020; E-021; E-022; E-023; E-078; E-079; E-080; E-081	Read Manual	Wait until the rotor has stopped. Check, if the rotor is qualified for the centrifuge. [→  35] Check, if the bottom of the rotor is damaged and if the rotor is placed on the Auto-Lock correctly. If the error message still shows, contact a service technician.
E-019	Rotor Unknown	Restart the centrifuge. Check, if the rotor is qualified for the centrifuge. [→  35] If the error message still shows, contact a service technician.

Error	Description	Solutions
E-025; E-027	Read Manual	Check, if the centrifuge door is blocked. Restart the centrifuge. If the error message still shows, contact a service technician.
E-029; E-045	Read Manual	Check, if a rotor is installed. Check, if the rotor is qualified for the centrifuge. [→ ⓘ 35] Restart the centrifuge. If the error message still shows, contact a service technician.
E-030	Power Failure	Check the power supply of the centrifuge. Make sure not to operate too many devices at one power source. Let the centrifuge cool down for 15 minutes. If the error message still shows, contact a service technician.
E-098	Imbalance Load	Check the load placed in the rotor. Check that the rotor cross bolts are greased well. Restart the centrifuge. If the error message still shows, contact a service technician.
E-060	Temp Low!	CAUTION Icy metal parts! Restart the centrifuge. If the error message still shows, contact a service technician.
E-046	Door Open!	Restart the centrifuge. If the error message still shows, contact a service technician.
E-099	Set Speed Too High	The installed rotor is not rated for the programmed speed. Check the programmed speed.

Table 1: Troubleshooting

5.3.1. Information for the Customer Service

If you need to contact customer service, please provide the order no. and the serial no. of your centrifuge. This information can be found on the nameplate at the back near the inlet for the power supply cable.

In addition the customer service also needs the Software ID and the NVRAM ID. Both are available in the system menu.

6. Technical Specifications

6.1. List of Centrifuges

Article No.	Centrifuge
75007220	SL 8, 120 V \pm 10 %, 60 Hz
75007221	SL 8, 220–230 V \pm 10 %, 50 / 60 Hz
75007223	SL 8R, 120 V \pm 10 %, 60 Hz
75007224	SL 8R, 220–230 V \pm 10 %, 50 / 60 Hz

Table 2: List of Centrifuges

6.2. List of Rotors

Article No.	Description
75005701	TX-150 swinging bucket rotor
75005702	TX-150 round buckets
75005703	TX-150 50mL conical buckets
75005704	TX-100S clinical swinging bucket rotor with sealed carriers
75005705	TX-100 clinical swinging bucket rotor with carriers
75005706	M10 microplate swinging bucket rotor
75005723	M10 buckets
75005721	M10 sealed buckets
75005600	MT-12 microtube swinging bucket rotor
75005709	HIGHConic III fixed angle rotor
75003623	CLINIConic fixed angle rotor
75005715	MicroClick 24 x 2 microtube rotor
75005719	MicroClick 30 x 2 microtube rotor
75003602	Microliter 48 x 2 sealed rotor
75005720	8 x 8 PCR Strip rotor
75005733	Hematocrit rotor
75003694	8 x 50 mL Individually Sealed rotor
75005765	MicroClick 18 x 5 microtube rotor

Table 3: Rotors

6.3. Technical Data



Thermo Scientific SL 8	
Speed Range (depending on the rotor)	300–16 000 rpm
RCF Value at max. Speed	24 328 x g
Running Time	99 h 59 min 50 sec, hold
Noise Level at max. Speed	< 58 dB (A) with a TX-150 rotor; < 61 dB (A) with a MicroClick 24x2 rotor; 1 m in front of the unit at 1.6 m height
Maximum Kinetic Energy	8.12 kNm
Average Heat Dissipation	0.31 kW/h
Environmental Conditions	
For Storage and Shipping	Temperature: -10 °C to 50 °C Humidity: 15 % to 85 %
For Operation	Use in interior spaces Altitudes of up to 2 000 m above sea level Temperature: 2 °C to 35 °C Max. relative humidity 80% up to 31 °C; decreasing linearly to 50% relative humidity at 40 °C
Pollution Degree	2
Overvoltage Category	II
IP	20
Dimensions	
Height (open door / closed door)	60.0 cm (23.6 in) / 31.0 cm (12.2 in)
Width	37.0 cm (14.6 in)
Depth	49.0 cm (19.3 in)
Weight (without rotor)	
	35 kg (77 lbs)

Table 4: Technical Data SL 8

Thermo Scientific SL 8R



Speed Range (depending on the rotor)	300–17 850 rpm
RCF Value at max. Speed	30279 x g
Running Time	99 h 59 min 50 sec, hold
Noise Level at max. Speed	< 56 dB (A) with a TX-150 rotor 1 m in front of the unit at 1.6 m height
Maximum Kinetic Energy	10.1 kNm
Average Heat Dissipation	0.35 kW/h

Environmental Conditions

For Storage and Shipping	Temperature: -10 °C to 50 °C Humidity: 15 % to 85 %
For Operation	Use in interior spaces Altitudes of up to 3000 m above sea level Temperature: 2 °C to 35 °C Max. relative humidity 80% up to 31 °C; decreasing linearly to 50% relative humidity at 40 °C
Pollution Degree	2
Overvoltage Category	II
IP	20

Dimensions

Height (open door / closed door)	70.0 cm (27.6 in) / 32.0 cm (12.6 in)
Width	46.0 cm (18.1 in)
Depth	67.0 cm (26.4 in)

Weight (without rotor)	74 kg (163 lbs)
-------------------------------	-----------------

Table 5: Technical Data SL 8R

6.3.1. Directives and Standards

Region	Directive	Standards
Europe 220-230 V, 50 / 60 Hz 230 V, 50 / 60 Hz	<u>(EU) 2017/746</u> In Vitro Diagnostics Medical Devices <u>2006/42/EC</u> Machinery Directive <u>2014/35/EU</u> Low Voltage (Protective Goals) <u>2014/30/EC</u> Electromagnetic Compatibility (EMC) <u>2011/65/EC RoHS</u> and all applicable amendments and additions Directive on the Restriction of the use of certain Hazardous Substances in electrical and electronic equipment	EN 61010-1 EN 61010-2-020 EN 61010-2-011 EN 61010-2-101 EN 61326-2-6 EN 61326-1 Class B EN ISO 14971 ISO 13485
North America 220-230 V, 50 / 60 Hz 120 V, 60 Hz	<u>FDA listed</u> Product code JQC centrifuges for clinical use Device class 1	ANSI/UL 61010-1 UL 61010-2-020 UL 61010-2-011 UL 61010-2-101 FCC Part 15 EN ISO 14971 ISO 13485
Japan 100 V, 50 / 60 Hz		IEC 61010-1 IEC 61010-2-020 IEC 61010-2-011 IEC 61010-2-101
China 230 V, 50 / 60 Hz 208-240 V, 50 / 60 Hz	<u>CFDA listed</u>	IEC 61326-2-6 IEC 61326-1 Class B EN ISO 14971 ISO 13485

Table 6: Directives and Standards

NOTICE: This equipment has been tested and found to comply with the limits for a Class B digital device, pursuant to part 15 of the FCC Rules. These limits are designed to provide reasonable protection against harmful interference in a residential installation. This equipment generates, uses and can radiate radio frequency energy and, if not installed and used in accordance with the instructions, may cause harmful interference to radio communications. However, there is no guarantee that interference will not occur in a particular installation. If this equipment does cause harmful interference to radio or television reception, which can be determined by turning the equipment off and on, the user is encouraged to try to correct the interference by one or more of the following measures:

- » Reorient or relocate the receiving antenna.
- » Increase the separation between the equipment and receiver.
- » Connect the equipment into an outlet on a circuit different from that to which the receiver is connected.
- » Consult the dealer or an experienced radio/TV technician for help.

6. 3. 2. Mains Supply

Article No.	Centrifuge	Voltage	Frequency	Rated Current	Power Consumption	Equipment Fuse	Building Fuse
75007220	SL 8	120 V ±10 %	60 Hz	5 A	310 W	10 AT	15 AT
75007221	SL 8	220–230 V ±10 %	50 / 60 Hz	2 A	310 W	5 AT	16 AT
75007223	SL 8R	120 V ±10 %	60 Hz	8 A	700 W	15 AT	15 AT
75007224	SL 8R	220–230 V ±10 %	50 / 60 Hz	4 A	750 W	15 AT	16 AT

Table 7: Mains Supply

6. 3. 3. Refrigerants

Article No.	Centrifuge	Refrigerant	Quantity	Low and high side max. pressure	GWP	CO2e
75007223	SL 8R	R-134a	0.265 kg	10 / 26 bar	1 430	0.38 t
75007224	SL 8R	R-134a	0.315 kg	10 / 21 bar	1 430	0.45 t

Contains fluorinated greenhouse gases in a hermetically sealed system.

Table 8: Refrigerants

7. Rotor Specifications

7.1. TX-150



7.1.1. Items Supplied

Item	Article No.	Quantity
TX-150 Rotor	75005701	1
Bolt Grease	75003786	1

Table 9: Items Supplied TX-150 Rotor

7.1.2. Technical Data

With Round Buckets

Weight (empty)	2.9 kg
Maximum Permissible Load	4 x 190 g
Maximum Number of Cycles	50 000
Radius (max. / min.)	14.4 cm / 5.1 cm
Angle	90°
Max. Autoclaving Temperature	121 °C
Aerosol-tight	Yes



Table 10: General Technical Data TX-150 Rotor with round buckets

With Conical Buckets

Weight (empty)	2.9 kg
Maximum Permissible Load	4 x 150 g
Maximum Number of Cycles	50 000
Radius (max. / min.)	14.4 cm / 4.5 cm
Angle	90°
Max. Autoclaving Temperature	121 °C
Aerosol-tight	No



Table 11: General Technical Data TX-150 Rotor with conical buckets

7.1.3. Rotor Performance Data

Ventilated Centrifuges – TX-150 Rotor with round buckets			
Voltage	230 V	120 V	100 V
Maximum Speed	4500 rpm	4500 rpm	4500 rpm
Maximum RCF-Value	3260 x g	3260 x g	3260 x g
K-Factor at max speed	12968	12968	12968
Acceleration / Braking Time	25 s / 30 s	20 s / 30 s	20 s / 30 s

Ventilated Centrifuges – TX-150 Rotor with round buckets			
Voltage	230 V	120 V	100 V
Sample Heating at max speed, 23 °C ambient temperature, 60 min running time	5 °C	5 °C	5 °C

Refrigerated Centrifuges – TX-150 Rotor with round buckets			
Voltage	230 V	120 V	100 V
Maximum Speed	4500 rpm	4500 rpm	4500 rpm
Maximum RCF-Value	3260 x g	3260 x g	3260 x g
K-Factor at n_{max}	12968	12968	12968
Acceleration / Braking Time	20 s / 30 s	20 s / 30 s	25 s / 30 s
Maximum Speed at 4 °C	50 Hz: 4500 rpm 60 Hz: 4500 rpm	60 Hz: 4500 rpm	50 Hz: 4500 rpm 60 Hz: 4500 rpm
Sample Temperature at max. Speed, Ambient Temperature of 23 °C, Run Time 90 min	50 Hz: < 4 °C 60 Hz: < 4 °C	60 Hz: < 4 °C	50 Hz: < 4 °C 60 Hz: < 4 °C

Ventilated Centrifuges – TX-150 Rotor with conical buckets			
Voltage	230 V	120 V	100 V
Maximum Speed	4500 rpm	4500 rpm	4500 rpm
Maximum RCF-Value	3260 x g	3260 x g	3260 x g
K-Factor at max speed	14532	14532	14532
Acceleration / Braking Time	25 s / 30 s	20 s / 30 s	20 s / 30 s
Sample Heating at max speed, 23 °C ambient temperature, 60 min running time	7 °C	7 °C	7 °C

Refrigerated Centrifuges – TX-150 Rotor with conical buckets			
Voltage	230 V	120 V	100 V
Maximum Speed	4500 rpm	4500 rpm	4500 rpm
Maximum RCF-Value	3260 x g	3260 x g	3260 x g
K-Factor at n_{max}	14532	14532	14532
Acceleration / Braking Time	20 s / 30 s	20 s / 30 s	25 s / 30 s
Maximum Speed at 4 °C	50 Hz: 4500 rpm 60 Hz: 4500 rpm	60 Hz: 4500 rpm	50 Hz: 4500 rpm 60 Hz: 4500 rpm
Sample Temperature at max. Speed, Ambient Temperature of 23 °C, Run Time 90 min	50 Hz: < 4 °C 60 Hz: < 4 °C	60 Hz: < 4 °C	50 Hz: < 4 °C 60 Hz: < 4 °C

Table 12: TX-150 Rotor Performance Data

7.1.4. Accessories

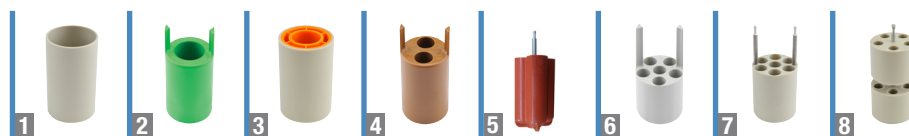

Article No.	Description	Rotor Capacity (places x volume, mL)	Max Tube Dimensions (Ø x L, mm)
75005703	50 mL Conical Buckets (unsealed, no adapter needed) (set of 4)	8 x 50	29.5 x 120
75005702	Round Buckets (set of 4)	4 x 145	50 x 100
75005707	Click Seal Biocontainment Lids for Round Buckets (set of 4)		
75005724	Replacement O-rings for Lids (set of 4)		
Adapters for 50 mL Conical Buckets (sets of 2)			
75005808	15 mL Conical Tube	8 x 15	17 x 123
Adapters for Round Buckets (sets of 4)			
Direct fit	145 mL Bottle (75005734)	4 x 145	50 x 100
1	75005735	100 mL Round Bottom Open-Top Tube	4 x 100
2	75005736	50 mL Conical or Skirted Tube	4 x 50
3	75005744	30 mL Sterilin™ Universal Container	4 x 30
4	75005737	15 mL Conical Tube	8 x 15
4	75005737	11 mL IVF Tube	8 x 11
5	75003504	13 mL Urine Tube	16 x 13
5	75003504	12 mL Blood Collection Tube (Greiner™)	16 x 12
5	75003504	10 mL Blood Collection or 15 mL Corex™/Kimble™ Tube	16 x 15
6	75005739	5/7 mL Blood Collection Tube	24 x 5/7
7	75005740	3/5 mL Blood Collection Tube or Cryotube	28 x 3/5
8	75005743	1.5/2 mL Microtube (or Microtainer™ tube)	40 x 2
Rotor Packages			
75005760	Cell Culture Package TX-150 Rotor (75005701), Round Buckets (75005702), Adapters for 50 mL Conical Tubes (75005736)	4 x 50	29.5 x 120
75005761	High Capacity Cell Culture Package TX-150 Rotor (75005701), Conical Buckets (75005703), Adapters for 15 mL Conical Tubes (75005808)	8 x 50	18 x 124
75005762	Clinical Rotor Package TX-150 Rotor (75005701), Round Buckets (75005702), ClickSeal Biocontainment Lids (75005707), Adapters for Blood Collection Tubes: 5/7 mL (75005739) and 10 mL (75005738)	24 x 5/7	18 x 124

Table 13: Accessories TX-150 Rotor

7. 1. 5. Biocontainment Certificate

Health Protection Agency
 Microbiology Services
 Porton Down
 Salisbury
 Wiltshire
 SP4 0JG



Certificate of Containment Testing

Containment Testing of 75005702 Bucket and 75005707 Cap in a Swing-out Rotor in a Thermo Scientific Centrifuge



Report No. 194-12 E

Report Prepared For: Thermo Fisher Scientific

Issue Date: 31st October 2012

Test Summary

A 75005702 bucket and 75005707 cap in a swing-out rotor was containment tested in a Thermo Scientific centrifuge at 4,500 rpm, using Annex AA of IEC 61010-2-020:2006 (2nd Ed.). The sealed rotor was shown to contain all contents.

<p>Report Written By</p>  <p>Name: Ms Anna Moy Title: Biosafety Scientist</p>	<p>Report Authorised By</p>  <p>Name: Mrs Sara Speight Title: Senior Biosafety Scientist</p>
--	---

Thermo Scientific is a trademark of Thermo Fisher Scientific and is registered with the USPTO.

7.2. TX-100S



7.2.1. Items Supplied

Item	Article No.	Quantity
TX-100S Rotor	75005704	1
Bolt Grease	75003786	1

Table 14: Items Supplied TX-100S Rotor

7.2.2. Technical Data

Weight (empty)	3.1 kg
Maximum Permissible Load	8 x 25 g
Maximum Number of Cycles	50 000
Radius (max. / min.)	14.4 cm / 4.4 cm
Angle	90°
Max. Autoclaving Temperature	121 °C
Aerosol-tight	Yes

Table 15: General Technical Data TX-100S Rotor

7.2.3. Rotor Performance Data

Ventilated Centrifuges – TX-100S Rotor			
Voltage	230 V	120 V	100 V
Maximum Speed	4 500 rpm	4 500 rpm	4 500 rpm
Maximum RCF-Value	3 260 x g	3 260 x g	3 260 x g
K-Factor at max speed	14 813	14 813	14 813
Acceleration / Braking Time	25 s / 30 s	20 s / 30 s	20 s / 30 s
Sample Heating at max speed, 23 °C ambient temperature, 60 min running time	7 °C	7 °C	7 °C

Refrigerated Centrifuges – TX-100S Rotor			
Voltage	230 V	120 V	100 V
Maximum Speed	4 500 rpm	4 500 rpm	4 500 rpm
Maximum RCF-Value	3 260 x g	3 260 x g	3 260 x g
K-Factor at n_{max}	14 813	14 813	14 813
Acceleration / Braking Time	20 s / 30 s	20 s / 30 s	25 s / 30 s
Maximum Speed at 4 °C	50 Hz: 4 500 rpm 60 Hz: 4 500 rpm	60 Hz: 4 500 rpm	50 Hz: 4 500 rpm 60 Hz: 4 500 rpm
Sample Temperature at max. Speed, Ambient Temperature of 23 °C, Run Time 90 min	50 Hz: < 4 °C 60 Hz: < 4 °C	60 Hz: < 4 °C	50 Hz: < 4 °C 60 Hz: < 4 °C

Table 16: TX-100S Rotor Performance Data

7. 2. 4. Accessories

Article No.	Description	Rotor Capacity (places x volume, mL)	Max Tube Dimensions (Ø x L, mm)
Adapters for TX-100S Clinical Rotor (each)			
Direct fit	10 mL Blood Collection Tube	16/8 x 10	16 x 100
11172596	5/7 mL BD Hemogard™/BD Vacutainer™ Tube	16/8 x 5/7	13 x 110
11172595	5 mL BD Hemogard Tube	16/8 x 5	13 x 75
11172287	3 mL Blood Collection Tube	16/8 x 3	11 x 70
11172288	1.5/2 mL Microtube (or Microtainer™ tube)	16/8 x 1.5/2	10 x 41

Table 17: Accessories TX-100S Rotor

7. 2. 5. Biocontainment Certificate

Health Protection Agency
Microbiology Services
Porton Down
Salisbury
Wiltshire
SP4 0JG



Certificate of Containment Testing

Containment Testing of 50110911 Tube and 50110924 Cap in a Swing-out Rotor in a Thermo Scientific Centrifuge



Report No. 194-12 F

Report Prepared For: Thermo Fisher Scientific

Issue Date: 31st October 2012

Test Summary

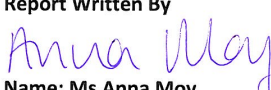
A 50110911 tube and 50110924 cap in a swing-out rotor was containment tested in a Thermo Scientific centrifuge at 4,500 rpm, using Annex AA of IEC 61010-2-020:2006 (2nd Ed.). The sealed rotor was shown to contain all contents.

Report Written By  Name: Ms Anna Moy Title: Biosafety Scientist	Report Authorised By  Name: Mrs Sara Speight Title: Senior Biosafety Scientist
--	---

Thermo Scientific is a trademark of Thermo Fisher Scientific and is registered with the USPTO.

7.3. TX-100



7.3.1. Items Supplied

Item	Article No.	Quantity
TX-100 Rotor	75005705	1
Bolt Grease	75003786	1

Table 18: Items Supplied TX-100 Rotor

7.3.2. Technical Data

Weight (empty)	3.3 kg
Maximum Permissible Load	16 x 25 g
Maximum Number of Cycles	50 000
Radius (max. / min.)	14.4 cm / 4.6 cm
Angle	90°
Max. Autoclaving Temperature	121 °C
Aerosol-tight	No

Table 19: General Technical Data TX-100 Rotor

7.3.3. Rotor Performance Data

Ventilated Centrifuges – TX-100 Rotor			
Voltage	230 V	120 V	100 V
Maximum Speed	4 500 rpm	4 500 rpm	4 500 rpm
Maximum RCF-Value	3 260 x g	3 260 x g	3 260 x g
K-Factor at max speed	14 258	14 258	14 258
Acceleration / Braking Time	25 s / 30 s	20 s / 30 s	20 s / 30 s
Sample Heating at max speed, 23 °C ambient temperature, 60 min running time	7 °C	7 °C	7 °C

Refrigerated Centrifuges – TX-100 Rotor			
Voltage	230 V	120 V	100 V
Maximum Speed	4 500 rpm	4 500 rpm	4 500 rpm
Maximum RCF-Value	3 260 x g	3 260 x g	3 260 x g
K-Factor at n_{max}	14 258	14 258	14 258
Acceleration / Braking Time	20 s / 30 s	20 s / 30 s	25 s / 30 s
Maximum Speed at 4 °C	50 Hz: 4 500 rpm 60 Hz: 4 500 rpm	60 Hz: 4 500 rpm	50 Hz: 4 500 rpm 60 Hz: 4 500 rpm
Sample Temperature at max. Speed, Ambient Temperature of 23 °C, Run Time 90 min	50 Hz: < 4 °C 60 Hz: < 4 °C	60 Hz: < 4 °C	50 Hz: < 4 °C 60 Hz: < 4 °C

Table 20: TX-100 Rotor Performance Data

7.3.4. Accessories

Article No.	Description	Rotor Capacity (places x volume, mL)	Max Tube Dimensions (Ø x L, mm)
Adapters for TX-100 Rotor (each)			
Direct fit	13 mL Urine Tube	16/8 x 13	17 x 110
Direct fit	10 mL Blood Collection Tube	16/8 x 10	16 x 100
75008817	Sterilin Urine Tube	16/8 x 13	16 x 110
75008818	Sarstedt Blood Tube	16/8 x 10	16 x 75
11172596	5/7 mL BD Hemogard™/BD Vacutainer™ Tube	16/8 x 5/7	13 x 110
11172595	5 mL BD Hemogard Tube	16/8 x 5	13 x 75
11172287	3 mL Blood Collection Tube	16/8 x 3	11 x 70
11172288	1.5/2 mL Microtube (or Microtainer™ tube)	16/8 x 1.5/2	10 x 41

Table 21: Accessories TX-100 Rotor

7. 4. M10

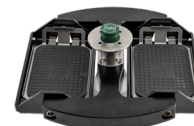

7. 4. 1. Items Supplied

Item	Article No.	Quantity
M10 Rotor	75005706	1
Bolt Grease	75003786	1
Rubber Seal Grease	76003500	1

Table 22: Items Supplied M10 Rotor

7. 4. 2. Technical Data

With Standard Carriers

Weight (empty)	2.9 kg
Maximum Permissible Load	2 x 125 g
Maximum Number of Cycles	30 000
Radius (max. / min.)	11.9 cm / 8.0 cm
Angle	90°
Max. Autoclaving Temperature	121 °C
Aerosol-tight	No



Table 23: General Technical Data M10 Rotor with Standard Carriers

With Biocontainment Carriers

Weight (empty)	2.9 kg
Maximum Permissible Load	2 x 300 g
Maximum Number of Cycles	30 000
Radius (max. / min.)	11.9 cm / 6.3 cm
Angle	90°
Max. Autoclaving Temperature	121 °C
Aerosol-tight	Yes



Table 24: General Technical Data M10 Rotor with Biocontainment Carriers

7. 4. 3. Rotor Performance Data

Ventilated Centrifuges – M10 Rotor with Standard Carriers			
Voltage	230 V	120 V	100 V
Maximum Speed	4400 rpm	4400 rpm	4400 rpm
Maximum RCF-Value	2576 x g	2576 x g	2576 x g
K-Factor at max speed	5 189	5 189	5 189
Acceleration / Braking Time	25 s / 30 s	20 s / 30 s	25 s / 30 s
Sample Heating at max speed, 23 °C ambient temperature, 60 min running time	5 °C	5 °C	5 °C

Refrigerated Centrifuges – M10 Rotor with Standard Carriers			
Voltage	230 V	120 V	100 V
Maximum Speed	4400 rpm	4400 rpm	4400 rpm
Maximum RCF-Value	2576 x g	2576 x g	2576 x g
K-Factor at n_{max}	5 189	5 189	5 189
Acceleration / Braking Time	25 s / 25 s	20 s / 25 s	30 s / 25 s
Maximum Speed at 4 °C	50 Hz: 4 400 rpm 60 Hz: 4 400 rpm	60 Hz: 4 400 rpm	50 Hz: 4 400 rpm 60 Hz: 4 400 rpm
Sample Temperature at max. Speed, Ambient Temperature of 23 °C, Run Time 90 min	50 Hz: < 4 °C 60 Hz: < 4 °C	60 Hz: < 4 °C	50 Hz: < 4 °C 60 Hz: < 4 °C

Refrigerated Centrifuges – M10 Rotor with Biocontainment Carriers			
Voltage	230 V	120 V	100 V
Maximum Speed	4400 rpm	4400 rpm	4400 rpm
Maximum RCF-Value	2576 x g	2576 x g	2576 x g
K-Factor at n_{max}	8311	8311	8311
Acceleration / Braking Time	25 s / 25 s	20 s / 25 s	30 s / 25 s
Maximum Speed at 4 °C	50 Hz: 4 400 rpm 60 Hz: 4 400 rpm	60 Hz: 4 400 rpm	50 Hz: 4 400 rpm 60 Hz: 4 400 rpm
Sample Temperature at max. Speed, Ambient Temperature of 23 °C, Run Time 90 min	50 Hz: < 4 °C 60 Hz: < 4 °C	60 Hz: < 4 °C	50 Hz: < 4 °C 60 Hz: < 4 °C

Table 25: M10 Rotor Performance Data

7.4.4. Accessories

Article No.	Description	Rotor Capacity (places x volume, mL)	Max Tube Dimensions (Ø x L, mm)
75005723	Unsealed Buckets (set of 2)	4 Standard or 2 Midi-Deepwell	Height < 33 mm
75005721	Sealed Buckets (set of 2)	4 Standard or 2 Midi-Deepwell	Height < 33 mm

Table 26: Accessories M10 Rotor

7. 4. 5. Biocontainment Certificate



Public Health
England

Public Health England
Microbiology Services
Porton Down
Salisbury
Wiltshire
SP4 OJG

Certificate of Containment Testing

Containment Testing of Thermo Scientific M10 Swinging Bucket (75005721) and Sealing Caps (75005722) in a M10 rotor (75005706) in a Thermo Scientific Centrifuge

Report No. 76/13

Report Prepared For: Thermo Fisher Scientific

Issue Date: 13th February 2014

Test Summary

A Thermo Scientific M10 Swinging Bucket (75005721), Sealing Caps (75005722) and M10 rotor (75005706) were containment tested in a Thermo Scientific centrifuge at 4,400 rpm, using Annex AA of IEC 61010-2-020:2006 (2nd Ed.). The sealed buckets were shown to contain all contents.

Report Written By

Name: Miss Anna Moy
Title: Biosafety Scientist

Report Authorised By

Name: Mrs Sara Speight
Title: Senior Biosafety Scientist

Please be aware that the use of the Royal Coat of Arms is highly restricted and cannot be copied. Please do not put the PHE logo on your website or use our name to endorse your products. Any reference to PHE needs to be approved by us before it can be used.

7.5. MT-12

7.5.1. Items Supplied

Item	Article No.	Quantity
MT-12 Rotor	75005600	1

Table 27: Items Supplied MT-12 Rotor



7.5.2. Technical Data

Weight (empty)	1.8 kg
Maximum Permissible Load	12 x 4 g
Maximum Number of Cycles	50000
Radius (max. / min.)	8.7 cm / 4.6 cm
Angle	90°
Max. Autoclaving Temperature	121 °C
Aerosol-tight	No

Table 28: General Technical Data MT-12 Rotor

7.5.3. Rotor Performance Data

Ventilated Centrifuges – MT-12 Rotor			
Voltage	230 V	120 V	100 V
Maximum Speed	13000 rpm	13000 rpm	13000 rpm
Maximum RCF-Value	16438 x g	16438 x g	16438 x g
K-Factor at max speed	954	954	954
Acceleration / Braking Time	45 s / 50 s	30 s / 45 s	35 s / 45 s
Sample Heating at max speed, 23 °C ambient temperature, 60 min running time	7 °C	7 °C	7 °C

Refrigerated Centrifuges – MT-12 Rotor			
Voltage	230 V	120 V	100 V
Maximum Speed	13000 rpm	13000 rpm	13000 rpm
Maximum RCF-Value	16438 x g	16438 x g	16438 x g
K-Factor at n_{max}	954	954	954
Acceleration / Braking Time	40 s / 50 s	40 s / 50 s	45 s / 50 s
Maximum Speed at 4 °C	50 Hz: 13000 rpm 60 Hz: 13000 rpm	60 Hz: 13000 rpm	50 Hz: 13000 rpm 60 Hz: 13000 rpm
Sample Temperature at max. Speed, Ambient Temperature of 23 °C, Run Time 90 min	50 Hz: 4 °C 60 Hz: < 4 °C	60 Hz: < 4 °C	50 Hz: < 4 °C 60 Hz: < 4 °C

Table 29: MT-12 Rotor Performance Data

7.5.4. Accessories

Article No.	Description	Rotor Capacity (places x volume, mL)	Max Tube Dimensions (Ø x L, mm)
75005730	Replacement ClickSeal Biocontainment Lid (each)		
75005726	Replacement Sealings (set of 2 with grease)		

Table 30: Accessories MT-12 Rotor

7. 6. HIGHConic III



7. 6. 1. Items Supplied

Item	Article No.	Quantity
HIGHConic II Rotor	75005709	1
Sealing Set	75005726	1
Rubber Seal Grease	76003500	1

Table 31: Items Supplied HIGHConic III Rotor

7. 6. 2. Technical Data

Weight (empty)	2.7 kg
Maximum Permissible Load	6 x 75 g
Maximum Number of Cycles	50 000
Radius (max. / min.)	12.0 cm / 5.7 cm
Angle	45°
Max. Autoclaving Temperature	121 °C
Aerosol-tight	Yes

Table 32: General Technical Data HIGHConic III Rotor

7. 6. 3. Rotor Performance Data

Ventilated Centrifuges – HIGHConic III Rotor			
Voltage	230 V	120 V	100 V
Maximum Speed	8 700 rpm	8 700 rpm	8 700 rpm
Maximum RCF-Value	10 155 x g	10 155 x g	10 155 x g
K-Factor at max speed	2 488	2 488	2 488
Acceleration / Braking Time	45 s / 50 s	35 s / 50 s	40 s / 50 s
Sample Heating at max speed, 23 °C ambient temperature, 60 min running time	14 °C	14 °C	14 °C

Refrigerated Centrifuges – HIGHConic III Rotor			
Voltage	230 V	120 V	100 V
Maximum Speed	9 500 rpm	9 500 rpm	9 500 rpm
Maximum RCF-Value	12 108 x g	12 108 x g	12 108 x g
K-Factor at n_{max}	2 087	2 087	2 087
Acceleration / Braking Time	40 s / 45 s	45 s / 45 s	55 s / 45 s
Maximum Speed at 4 °C	50 Hz: 8 700 rpm 60 Hz: 8 700 rpm	60 Hz: 8 700 rpm	50 Hz: 8 700 rpm 60 Hz: 8 700 rpm

Refrigerated Centrifuges – HIGHConic III Rotor			
Voltage	230 V	120 V	100 V
Sample Temperature at max. Speed, Ambient Temperature of 23 °C, Run Time 90 min	50 Hz: < 4 °C 60 Hz: < 4 °C	60 Hz: < 4 °C	50 Hz: < 4 °C 60 Hz: < 4 °C

Table 33: HIGHConic III Rotor Performance Data

7. 6. 4. Accessories

Article No.	Description	Rotor Capacity (places x volume, mL)	Max Tube Dimensions (Ø x L, mm)
75005731	Replacement Lid (each)		
75003058	Replacement Sealings (set of 2 with grease)		
Adapters for HIGHConic III Rotor (set of 2)			
Direct fit	50 mL Round Bottom Tube	6 x 50	30 x 115
75005802	38 mL Round Bottom Tube	6 x 38	25.5 x 110
75005803	16 mL Round Bottom Tube	6 x 16	18 x 123
75005808	15 mL Conical Tube	6 x 15	17 x 123
75005804	12 mL Round Bottom Tube	6 x 12	16 x 95
75005805	6.5 mL Round Bottom Tube	6 x 6.5	13.5 x 114
75005770	5 mL Conical Microtube	6 x 5	17 x 100
75005806	3.5 mL Round Bottom Tube	12 x 3.5	11 x 100
75005807	1.5/2 mL Microtube	12 x 2	11 x 40

Table 34: Accessories HIGHConic III Rotor

7. 6. 5. Biocontainment Certificate

Health Protection Agency
 Microbiology Services
 Porton Down
 Salisbury
 Wiltshire
 SP4 0JG



Certificate of Containment Testing

Containment Testing of Rotor 75005709 HIGHConic III 6x50 in a Thermo Scientific Centrifuge

Report No. 194-12 D

Report Prepared For: Thermo Fisher Scientific
Issue Date: 30th October 2012

Test Summary

A 75005709 HIGHConic III 6x50 rotor was containment tested in a Thermo Scientific centrifuge at 10,000 rpm, using Annex AA of IEC 61010-2-20:2006 (2nd Ed.). The sealed rotor was shown to contain all contents.

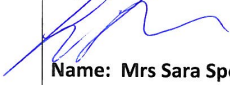
Report Written By  Name: Ms Anna Moy Title: Biosafety Scientist	Report Authorised By  Name: Mrs Sara Speight Title: Senior Biosafety Scientist
--	---

Thermo Scientific is a trademark of Thermo Fisher Scientific and is registered with the USPTO.

7.7. CLINIConic



7.7.1. Items Supplied

Item	Article No.	Quantity
CLINIConic Rotor	75003623	1

Table 35: Items Supplied CLINIConic Rotor

7.7.2. Technical Data

Weight (empty)	4.7 kg
Maximum Permissible Load	30 x 30 g
Maximum Number of Cycles	50000
Radius (max. / min.)	14.4 cm / 8.5 cm
Angle	37°
Max. Autoclaving Temperature	121 °C
Aerosol-tight	No

Table 36: General Technical Data CLINIConic Rotor

7.7.3. Rotor Performance Data

Ventilated Centrifuges – CLINIConic Rotor			
Voltage	230 V	120 V	100 V
Maximum Speed	4 400 rpm	4 400 rpm	4 400 rpm
Maximum RCF-Value	3 030 x g	3 030 x g	3 030 x g
K-Factor at max speed	6 521	6 521	6 521
Acceleration / Braking Time	30 s / 30 s	25 s / 30 s	30 s / 30 s
Sample Heating at max speed, 23 °C ambient temperature, 60 min running time	14 °C	14 °C	14 °C

Refrigerated Centrifuges – CLINIConic Rotor			
Voltage	230 V	120 V	100 V
Maximum Speed	4 400 rpm	4 400 rpm	4 400 rpm
Maximum RCF-Value	3 030 x g	3 030 x g	3 030 x g
K-Factor at n_{max}	6 521	6 521	6 521
Acceleration / Braking Time	25 s / 30 s	25 s / 30 s	30 s / 30 s
Maximum Speed at 4 °C	50 Hz: 4 400 rpm 60 Hz: 4 400 rpm	60 Hz: 4 400 rpm	50 Hz: 4 400 rpm 60 Hz: 4 400 rpm
Sample Temperature at max. Speed, Ambient Temperature of 23 °C, Run Time 90 min	50 Hz: < 4 °C 60 Hz: < 4 °C	60 Hz: < 4 °C	50 Hz: < 4 °C 60 Hz: < 4 °C

Table 37: CLINIConic Rotor Performance Data

7.7.4. Accessories

Article No.	Description	Rotor Capacity (places x volume, mL)	Max Tube Dimensions (Ø x L, mm)
Adapters for CLINiConic Rotor (each)			
Direct fit	15 mL Round/Conical Bottom Tube	30 x 15	16.5 x 131
75008817	10 mL Round Bottom Tube	30 x 10	16.5 x 95
11172596	5/7 mL BD Hemogard / BD Vacutainer Tube	30 x 5/7	13 x 106
11172595	5 mL BD Hemogard Tube	30 x 5	13 x 75

Table 38: Accessories CLINiConic Rotor

7. 8. MicroClick 18 x 5



7. 8. 1. Items Supplied

Item	Article No.	Quantity
MicroClick 18 x 5 Rotor	75005765	1
Sealing Set	75005726	1
Rubber Seal Grease	76003500	1

Table 39: Items Supplied MicroClick 18 x 5 Rotor

7. 8. 2. Technical Data

Weight (empty)	1.7 kg
Maximum Permissible Load	18 x 9 g
Maximum Number of Cycles	50 000
Radius (max. / min.)	10.2 cm / 7.0 cm
Angle	45°
Max. Autoclaving Temperature	121 °C
Aerosol-tight	Yes

Table 40: General Technical Data MicroClick 18 x 5 Rotor

7. 8. 3. Rotor Performance Data

Refrigerated Centrifuges – MicroClick 18 x 5 Rotor			
Voltage	230 V	120 V	100 V
Maximum Speed	14 000 rpm	14 000 rpm	14 000 rpm
Maximum RCF-Value	22 351 x g	22 351 x g	22 351 x g
K-Factor at n_{max}	486	486	486
Acceleration / Braking Time	55 s / 55 s	50 s / 55 s	65 s / 55 s
Maximum Speed at 4 °C	50 Hz: 12 400 rpm 60 Hz: 13 000 rpm	60 Hz: 13 500 rpm	50 Hz: 13 700 rpm 60 Hz: 14 000 rpm
Sample Temperature at max. Speed, Ambient Temperature of 23 °C, Run Time 90 min	50 Hz: < 4 °C 60 Hz: < 4 °C	60 Hz: < 4 °C	50 Hz: < 4 °C 60 Hz: < 4 °C

Table 41: MicroClick 18 x 5 Rotor Performance Data

7. 8. 4. Accessories

Article No.	Description	Rotor Capacity (places x volume, mL)	Max Tube Dimensions (Ø x L, mm)
75005730	Replacement ClickSeal Biocontainment Lid (each)		
75005726	Replacement Sealing Rings (set of 2 with grease)		
Adapters for MicroClick 18 x 5 Rotor (set of 2)			
75005756	1.5/2 mL Microtube	18 x 1.5/2	11 x 45

Table 42: Accessories MicroClick 18 x 5 Rotor

7. 8. 5. Biocontainment Certificate



Public Health England
Microbiology Services
Porton Down
Salisbury
Wiltshire
SP4 OJG

Certificate of Containment Testing

Containment Testing of Thermo Scientific Rotor MicroClick 18x5 (75005765) in a Thermo Scientific Centrifuge

Report No. 102/13

Report Prepared For: Thermo Fisher Scientific
Issue Date: 13th February 2014

Test Summary

A Thermo Scientific MicroClick 18x5 rotor (75005765) was containment tested in a Thermo Scientific centrifuge at 15,000 rpm, using Annex AA of IEC 61010-2-020:2006 (2nd Ed.). The sealed rotor was shown to contain all contents.

Report Written By

Name: Miss Anna Moy
Title: Biosafety Scientist

Report Authorised By

Name: Mrs Sara Speight
Title: Senior Biosafety Scientist

Please be aware that the use of the Royal Coat of Arms is highly restricted and cannot be copied. Please do not put the PHE logo on your website or use our name to endorse your products. Any reference to PHE needs to be approved by us before it can be used.

7.9. MicroClick 24 x 2



7.9.1. Items Supplied

Item	Article No.	Quantity
MicroClick 24 x 2 Rotor	75005715	1
Sealing Set	75003405	1
Rubber Seal Grease	76003500	1

Table 43: Items Supplied MicroClick 24 x 2 Rotor

7.9.2. Technical Data

Weight (empty)	1.2 kg
Maximum Permissible Load	24 x 4 g
Maximum Number of Cycles	50 000
Radius (max. / min.)	8.5 cm / 5.1 cm
Angle	45°
Max. Autoclaving Temperature	121 °C

Table 44: General Technical Data MicroClick 24 x 2 Rotor

7.9.3. Rotor Performance Data

Ventilated Centrifuges – MicroClick 24 x 2 Rotor			
Voltage	230 V	120 V	100 V
Maximum Speed	16 000 rpm	16 000 rpm	16 000 rpm
Maximum RCF-Value	24 328 x g	24 328 x g	24 328 x g
K-Factor at max speed	505	505	505
Acceleration / Braking Time	30 s / 45 s	30 s / 45 s	35 s / 45 s
Sample Heating at max speed, 23 °C ambient temperature, 60 min running time	18 °C	18 °C	18 °C
Aerosol-tight	Yes	Yes	Yes

Refrigerated Centrifuges – MicroClick 24 x 2 Rotor			
Voltage	230 V	120 V	100 V
Maximum Speed	17 850 rpm	17 850 rpm	17 850 rpm
Maximum RCF-Value	30 279 x g	30 279 x g	30 279 x g
K-Factor at n_{max}	406	406	406
Acceleration / Braking Time	35 s / 45 s	30 s / 50 s	40 s / 50 s
Maximum Speed at 4 °C	50 Hz: 15 200 rpm 60 Hz: 16 800 rpm	60 Hz: 17 400 rpm	50 Hz: 17 500 rpm 60 Hz: 17 500 rpm
Sample Temperature at max. Speed, Ambient Temperature of 23 °C, Run Time 90 min	50 Hz: < 4 °C 60 Hz: < 4 °C	60 Hz: < 4 °C	50 Hz: < 4 °C 60 Hz: < 4 °C
Aerosol-tight	Yes	Yes	Yes

Table 45: MicroClick 24 x 2 Rotor Performance Data

7.9.4. Accessories

Article No.	Description	Rotor Capacity (places x volume, mL)	Max Tube Dimensions (Ø x L, mm)
75005725	Replacement ClickSeal Biocontainment Lid (each)		
75003405	Replacement Sealing for Lid (each)		
Adapters for MicroClick 24 x 2 Rotor (sets of 30)			
75005752	0.2 mL PCR Tube	24 x 0.2	6.5 x 20
75005753	0.5 mL Microtube	24 x 0.5	8 x 44
75005754	0.25 mL Microtube	24 x 0.25	6 x 46

Table 46: Accessories MicroClick 24 x 2 Rotor

7.9.5. Biocontainment Certificate

Health Protection Agency
Microbiology Services
Porton Down
Salisbury
Wiltshire
SP4 0JG



Certificate of Containment Testing

Containment Testing of Rotor 75005715 MicroClick 24x2 in a Thermo Scientific Centrifuge

Report No. 194-12 A

Report Prepared For: Thermo Fisher Scientific

Issue Date: 30th October 2012

Test Summary

A 75005715 MicroClick 24x2 rotor was containment tested in a Thermo Scientific centrifuge at 18,000 rpm, using Annex AA of IEC 61010-2-20:2006 (2nd Ed.). The sealed rotor was shown to contain all contents.

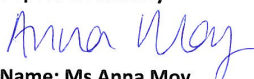
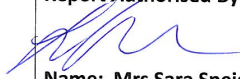
Report Written By  Name: Ms Anna Moy Title: Biosafety Scientist	Report Authorised By  Name: Mrs Sara Speight Title: Senior Biosafety Scientist
--	---

Thermo Scientific is a trademark of Thermo Fisher Scientific and is registered with the USPTO.

7. 10. MicroClick 30 x 2



7. 10. 1. Items Supplied

Item	Article No.	Quantity
MicroClick 30 x 2 Rotor	75005719	1
Sealing Set	75005726	1
Rubber Seal Grease	76003500	1

Table 47: Items Supplied MicroClick 30 x 2 Rotor

7. 10. 2. Technical Data

Weight (empty)	1.5 kg
Maximum Permissible Load	30 x 4 g
Maximum Number of Cycles	50 000
Radius (max. / min.)	9.9 cm / 6.4 cm
Angle	45°
Max. Autoclaving Temperature	121 °C
Aerosol-tight	Yes

Table 48: General Technical Data MicroClick 30 x 2 Rotor

7. 10. 3. Rotor Performance Data

Ventilated Centrifuges – MicroClick 30 x 2 Rotor			
Voltage	230 V	120 V	100 V
Maximum Speed	14 000 rpm	14 000 rpm	14 000 rpm
Maximum RCF-Value	21 694 x g	21 694 x g	21 694 x g
K-Factor at max speed	563	563	563
Acceleration / Braking Time	40 s / 50 s	30 s / 50 s	40 s / 50 s
Sample Heating at max speed, 23 °C ambient temperature, 60 min running time	24 °C	24 °C	24 °C

Refrigerated Centrifuges – MicroClick 30 x 2 Rotor			
Voltage	230 V	120 V	100 V
Maximum Speed	14 000 rpm	14 000 rpm	14 000 rpm
Maximum RCF-Value	21 694 x g	21 694 x g	21 694 x g
K-Factor at n_{max}	563	563	563
Acceleration / Braking Time	40 s / 50 s	40 s / 50 s	50 s / 50 s
Maximum Speed at 4 °C	50 Hz: 13 000 rpm 60 Hz: 13 500 rpm	60 Hz: 14 000 rpm	50 Hz: 14 000 rpm 60 Hz: 14 000 rpm
Sample Temperature at max. Speed, Ambient Temperature of 23 °C, Run Time 90 min	50 Hz: < 4 °C 60 Hz: < 4 °C	60 Hz: < 4 °C	50 Hz: < 4 °C 60 Hz: < 4 °C

Table 49: MicroClick 30 x 2 Rotor Performance Data

7. 10. 4. Accessories

Article No.	Description	Rotor Capacity (places x volume, mL)	Max Tube Dimensions (Ø x L, mm)
75005730	Replacement ClickSeal Biocontainment Lid (each)		
75005726	Replacement Sealing for Lid (each)		
Adapters for MicroClick 30 x 2 Rotor (sets of 30)			
75005752	0.2 mL PCR Tube	30 x 0.2	6.5 x 20
75005753	0.5 mL Microtube	30 x 0.5	8 x 44
75005754	0.25 mL Microtube	30 x 0.25	6 x 46

Table 50: Accessories MicroClick 30 x 2 Rotor

7. 10. 5. Biocontainment Certificate

Health Protection Agency
Microbiology Services
Porton Down
Salisbury
Wiltshire
SP4 0JG



Certificate of Containment Testing

Containment Testing of Rotor 75005719 MicroClick 30x2 in a Thermo Scientific Centrifuge



Report No. 194-12 B

Report Prepared For: Thermo Fisher Scientific

Issue Date: 30th October 2012

Test Summary

A 75005719 MicroClick 30x2 rotor was containment tested in a Thermo Scientific centrifuge at 15,000 rpm, using Annex AA of IEC 61010-2-20:2006 (2nd Ed.). The sealed rotor was shown to contain all contents.

Report Written By  Name: Ms Anna Moy Title: Biosafety Scientist	Report Authorised By  Name: Mrs Sara Speight Title: Senior Biosafety Scientist
--	---

Thermo Scientific is a trademark of Thermo Fisher Scientific and is registered with the USPTO.

7. 11. Microliter 48 x 2



7. 11. 1. Items Supplied

Item	Article No.	Quantity
Microliter 48 x 2 Rotor incl. Rotor Lid	75003602	1
Rubber Seal Grease	76003500	1

Table 51: Items Supplied Microliter 48x 2 Rotor

7. 11. 2. Technical Data

Weight (empty)	2.4 kg
Maximum Permissible Load	48 x 4 g
Maximum Number of Cycles	50 000
Radius (max. / min.)	9.8 cm / 5.9 cm
Angle	45°
Max. Autoclaving Temperature	138 °C
Aerosol-tight	Yes

Table 52: General Technical Data Microliter 48 x 2 Rotor

7. 11. 3. Rotor Performance Data

Ventilated Centrifuges – Microliter 48 x 2 Rotor			
Voltage	230 V	120 V	100 V
Maximum Speed	11 800 rpm	11 800 rpm	11 800 rpm
Maximum RCF-Value	15 256 x g	15 256 x g	15 256 x g
K-Factor at max speed	922	922	922
Acceleration / Braking Time	45 s / 65 s	45 s / 65 s	55 s / 65 s
Sample Heating at max speed, 23 °C ambient temperature, 60 min running time	15 °C	15 °C	15 °C

Refrigerated Centrifuges – Microliter 48 x 2 Rotor			
Voltage	230 V	120 V	100 V
Maximum Speed	12 900 rpm	12 900 rpm	12 900 rpm
Maximum RCF-Value	18 233 x g	18 233 x g	18 233 x g
K-Factor at n_{max}	771	771	771
Acceleration / Braking Time	50 s / 65 s	55 s / 60 s	60 s / 60 s
Maximum Speed at 4 °C	50 Hz: 12 900 rpm 60 Hz: 12 900 rpm	60 Hz: 12 900 rpm	50 Hz: 12 900 rpm 60 Hz: 12 900 rpm
Sample Temperature at max. Speed, Ambient Temperature of 23 °C, Run Time 90 min	50 Hz: < 4 °C 60 Hz: < 4 °C	60 Hz: < 4 °C	50 Hz: < 4 °C 60 Hz: < 4 °C

Table 53: Microliter 48 x 2 Rotor Performance Data

7.12. 8 x 8 PCR Strip



7.12.1. Items Supplied

Item	Article No.	Quantity
8 x 8 PCR Strip Rotor	75005720	1
Sealing Set	75005726	1
Rubber Seal Grease	76003500	1

Table 55: Items Supplied TX-100S Rotor

7.12.2. Technical Data

Weight (empty)	1.4 kg
Maximum Permissible Load	64 x 0.5 g
Maximum Number of Cycles	50 000
Radius (max. / min.)	7.1 cm / 4.4 cm
Angle	45°
Max. Autoclaving Temperature	121 °C
Aerosol-tight	Yes

Table 56: General Technical Data 8 x 8 PCR Strip Rotor

7.12.3. Rotor Performance Data

Ventilated Centrifuges – 8 x 8 PCR Strip Rotor			
Voltage	230 V	120 V	100 V
Maximum Speed	15 000 rpm	15 000 rpm	15 000 rpm
Maximum RCF-Value	17 860 x g	17 860 x g	17 860 x g
K-Factor at max speed	538	538	538
Acceleration / Braking Time	30 s / 40 s	25 s / 40 s	30 s / 40 s
Sample Heating at max speed, 23 °C ambient temperature, 60 min running time	12 °C	12 °C	12 °C

Refrigerated Centrifuges – 8 x 8 PCR Strip Rotor			
Voltage	230 V	120 V	100 V
Maximum Speed	15 000 rpm	15 000 rpm	15 000 rpm
Maximum RCF-Value	17 860 x g	17 860 x g	17 860 x g
K-Factor at n_{max}	538	538	538
Acceleration / Braking Time	30 s / 45 s	25 s / 45 s	30 s / 45 s
Maximum Speed at 4 °C	50 Hz: 15 000 rpm 60 Hz: 15 000 rpm	60 Hz: 15 000 rpm	50 Hz: 15 000 rpm 60 Hz: 15 000 rpm

Refrigerated Centrifuges – 8 x 8 PCR Strip Rotor			
Voltage	230 V	120 V	100 V
Sample Temperature at max. Speed, Ambient Temperature of 23 °C, Run Time 90 min	50 Hz: < 4 °C 60 Hz: < 4 °C	60 Hz: < 4 °C	50 Hz: < 4 °C 60 Hz: < 4 °C

Table 57: 8 x 8 PCR Strip Rotor Performance Data

7. 12. 4. Accessories

Article No.	Description	Rotor Capacity (places x volume, mL)	Max Tube Dimensions (Ø x L, mm)
75005730	Replacement ClickSeal Biocontainment Lid (each)		
75005726	Replacement Sealing for Lid (each)		

Table 58: Accessories 8 x 8 PCR Strip Rotor

7. 12. 5. Biocontainment Certificate

Health Protection Agency
Microbiology Services
Porton Down
Salisbury
Wiltshire
SP4 0JG



Certificate of Containment Testing

Containment Testing of Rotor 75005720 MicroClick PCR 8x8 in a Thermo Scientific Centrifuge



Report No. 194-12 C

Report Prepared For: Thermo Fisher Scientific

Issue Date: 30th October 2012

Test Summary

A 75005720 MicroClick PCR 8x8 rotor was containment tested in a Thermo Scientific centrifuge at 15,000 rpm, using Annex AA of IEC 61010-2-20:2006 (2nd Ed.). The sealed rotor was shown to contain all contents.

Report Written By  Name: Ms Anna Moy Title: Biosafety Scientist	Report Authorised By  Name: Mrs Sara Speight Title: Senior Biosafety Scientist
--	---

Thermo Scientific is a trademark of Thermo Fisher Scientific and is registered with the USPTO.

7.13. 8 x 50 mL Individually Sealed



7.13.1. Items Supplied

Item	Article No.	Quantity
8 x 50 mL Individually Sealed Rotor	75003694	1

Table 59: Items Supplied TX-100S Rotor

7.13.2. Technical Data

Weight (empty)	3.3 kg
Maximum Permissible Load	8 x 189 g
Maximum Number of Cycles	50 000
Radius (max. / min.)	14.3 cm / 6.9 cm
Angle	45°
Max. Autoclaving Temperature	121 °C

Table 60: General Technical Data 8 x 50 Individually Sealed Rotor

7.13.3. Rotor Performance Data

Refrigerated Centrifuges – 8 x 50 Individually Sealed Rotor			
Voltage	230 V	120 V	100 V
Maximum Speed	5 600 rpm	5 600 rpm	5 600 rpm
Maximum RCF-Value	5 014 x g	5 014 x g	5 014 x g
K-Factor at n_{max}	5 879	5 879	5 879
Acceleration / Braking Time	35 s / 40 s	30 s / 40 s	35 s / 40 s
Maximum Speed at 4 °C	50 Hz: 5 600 rpm 60 Hz: 5 600 rpm	60 Hz: 5 600 rpm	50 Hz: 5 600 rpm 60 Hz: 5 600 rpm
Sample Temperature at max. Speed, Ambient Temperature of 23 °C, Run Time 90 min	50 Hz: < 4 °C 60 Hz: < 4 °C	60 Hz: < 4 °C	50 Hz: < 4 °C 60 Hz: < 4 °C
Aerosol-tight	Yes	Yes	Yes

Table 61: 8 x 50 Individually Sealed Rotor Performance Data

7.13.4. Accessories

Article No.	Description	Rotor Capacity (places x volume, mL)	Max Tube Dimensions (Ø x L, mm)
75003011	Replacement Biocontainment Lids (set of 2)		
75003789	Replacement O-ring Kit		
Adapters for 8 x 50 Individually Sealed Rotor (each)			
Direct fit	50 mL Round Bottom Tube	6 x 50	30 x 115
75005802	38 mL Round Bottom Tube	6 x 38	25.5 x 110
75005803	16 mL Round Bottom Tube	6 x 16	18 x 123
75005808	15 mL Conical Tube	6 x 15	17 x 123
75005804	12 mL Round Bottom Tube	6 x 12	16 x 95
75005805	6.5 mL Round Bottom Tube	6 x 6.5	13.5 x 114
75005770	5 mL Conical Microtube	6 x 5	17 x 100
75005806	3.5 mL Round Bottom Tube	12 x 3.5	11 x 100
75005807	1.5/2 mL Microtube	12 x 2	11 x 40

Table 62: Accessories 8 x 50 Individually Sealed Rotor

7.13.5. Biocontainment Certificate

Centre of Emergency Preparedness and Response
Health Protection Agency
Porton Down
Salisbury
Wiltshire SP4 0JG
United Kingdom



Certificate of Containment Testing

**Containment testing of
Thermo Scientific Vessel 75003787**

Report No. 77- 08 B

Report prepared for: Thermo Fisher
Issue Date: 1st June 2009

Test Summary

A Thermo Scientific vessel 75003787 with aerosol tight lid (Max rcf 7177 x g) was supplied by Thermo Fisher and containment tested at max rcf 7177 x g using the method described in Annex AA of EN 61010-2-020. The vessel was shown to contain a spill when tested in triplicate.

Report Written By 

Report Authorised By 

7.14. Hematocrit Rotor

For more information on the hematocrit rotor refer to the separate rotor manual.

MATERIAL	Chemical Compatibility																					
	FERRIC CHLORIDE	ACETIC ACID (GLACIAL)	ACETIC ACID (5%)	ACETIC ACID (60%)	ETHYL ACETATE	ETHYL ALCOHOL (50%)	ETHYL ALCOHOL (95%)	ETHYLENE DICHLORIDE	ETHYLENE GLYCOL	ETHYLENE OXIDE VAPOR	FICOLL-HYPAAQUE™	HYDROFLUORIC ACID (10%)	HYDROFLUORIC ACID (50%)	HYDROCHLORIC ACID (CONC.)	FORMALDEHYDE (40%)	GLUTARALDEHYDE	GLYCEROL	GUANIDINE HYDROCHLORIDE	HAEMO-SOL™	HEXANE	ISOBUTYL ALCOHOL	
Viton™	S	U	M	U	U	U	U	S	S	U	S	S	/	M	/	U	S	S	S	S	S	S
Tygon™	/	/	S	M	U	U	M	U	M	S	S	S	/	/	/	M	U	S	S	S	U	/
Titanium	S	S	S	S	S	S	S	S	S	S	S	S	S	U	U	U	S	S	S	S	S	S
Stainless Steel	U	U	M	U	M	M	U	/	M	S	M	U	U	U	U	M	S	S	U	S	S	/
Silicone Rubber	M	U	S	M	M	S	S	U	S	U	S	U	U	U	S	S	S	S	S	U	S	S
Rulon A™, Teflon™	/	S	S	S	S	S	S	S	S	S	S	S	S	/	/	S	S	S	S	S	S	S
Polyvinyl Chloride	/	U	M	M	U	S	S	U	S	U	S	M	M	U	S	/	S	S	S	M	S	S
Polysulfone	/	M	S	S	U	S	M	/	S	S	S	S	S	/	M	S	S	S	S	S	/	S
Polypropylene	S	U	S	M	S	S	S	U	S	S	S	S	S	S	S	S	S	S	S	S	S	S
Polyethylene	S	S	S	S	S	S	S	U	S	S	S	S	S	/	S	S	S	S	S	U	S	S
Polythermide	/	M	S	M	/	S	S	U	S	/	S	S	U	U	U	U	/	/	/	S	S	S
Polyester, Glass Thermoset	/	U	S	S	U	S	/	U	S	/	/	U	U	U	S	/	S	/	/	S	M	S
Polycarbonate	/	U	S	U	U	U	U	U	U	M	S	U	U	U	S	S	S	/	/	U	S	S
Polyallomer	S	U	S	M	M	S	S	U	S	S	S	S	S	M	U	S	S	S	S	M	S	S
PET ¹ , Polyclear™, Clear Crimp™	/	U	M	U	U	U	U	U	/	/	/	U	U	U	M	S	S	S	S	U	U	U
Nylon	S	U	S	U	S	S	S	S	S	/	S	S	S	U	U	S	S	S	S	S	S	S
Noryl™	/	S	S	S	U	S	S	U	S	/	S	U	U	M	S	S	S	S	S	U	/	/
Neoprene	M	U	S	M	S	S	S	U	S	U	S	U	U	U	S	S	S	S	S	S	U	U
Glass	/	S	S	S	S	S	S	/	S	S	/	/	/	/	S	S	S	S	S	S	/	/
EPDM rubber	S	M	S	/	M	S	S	M	S	/	/	/	M	M	/	S	S	/	/	/	S	S
Delrin™	M	U	M	U	M	M	M	S	S	/	S	U	U	U	S	S	S	S	S	S	S	S
Composite Carbon Fiber/Epoxy	/	S	S	S	S	S	S	/	S	U	S	/	/	U	S	/	S	S	/	S	/	/
Polyurethane Rotor Paint	/	S	S	S	S	S	S	/	S	/	S	/	/	/	S	/	S	S	/	S	/	/
Cellulose Acetate Butyrate	/	U	S	U	U	S	U	U	S	/	/	U	U	U	S	S	/	/	/	S	U	/
Buna N	S	U	M	U	U	S	S	U	S	U	S	U	U	U	M	S	S	/	S	S	M	/
Anodic Coating for Aluminum	U	S	S	S	M	S	S	/	S	/	S	U	U	U	M	S	S	U	S	S	/	/
Aluminium	U	S	S	S	M	S	S	S	S	/	S	U	U	U	M	S	S	U	S	S	/	/
S	Satisfactory																					
M	Moderate attack, may be satisfactory for use in centrifuge depending on length of exposure, speed involved, etc.; suggest testing under actual conditions of use																					
U	Unsatisfactory, not recommended																					
/	Performance unknown; suggest testing, using sample to avoid loss of valuable material																					

MATERIAL	Chemical Compatibility																					
	ISOPROPYL ALCOHOL	IODOACETIC ACID	POTASSIUM BROMIDE	POTASSIUM CARBONATE	POTASSIUM CHLORIDE	POTASSIUM HYDROXIDE (5%)	POTASSIUM HYDROXIDE (CONC.)	POTASSIUM PERMANGANATE	CALCIUM CHLORIDE	CALCIUM HYPOCHLORITE	KEROSENE	SODIUM CHLORIDE (10%)	SODIUM CHLORIDE (SAT'D)	CARBON TETRACHLORIDE	AQUA REGIA	SOLUTION 555 (20%)	MAGNESIUM CHLORIDE	MERCAPTOACETIC ACID	METHYL ALCOHOL	METHYLENE CHLORIDE	METHYL ETHYL KETONE	
Viton™	S	M	S	S	S	U	U	U	S	S	U	S	S	S	M	S	S	S	S	U	U	U
Tygon™	M	M	S	S	S	S	/	U	S	S	/	U	/	S	/	S	S	S	M	S	U	U
Titanium	M	S	S	S	S	M	U	U	S	S	S	M	U	S	M	U	S	S	S	U	S	S
Stainless Steel	M	S	M	S	U	U	U	M	M	U	S	S	M	/	S	M	S	S	M	M	M	S
Silicone Rubber	S	M	S	S	S	M	/	S	S	M	U	S	S	M	/	S	S	U	S	S	S	S
Rulon A™, Teflon™	S	S	S	S	S	S	U	S	S	S	S	/	/	M	/	S	S	S	S	S	S	S
Polyvinyl Chloride	S	S	S	S	S	S	M	U	S	M	S	S	S	M	/	/	S	M	S	U	U	U
Polysulfone	S	S	/	S	S	S	/	S	S	S	M	S	/	S	S	S	S	S	U	U	U	U
Polypropylene	S	S	S	S	S	S	M	M	S	S	M	S	S	M	U	S	S	U	S	U	S	S
Polyethylene	S	S	S	S	S	S	S	S	S	S	M	S	S	M	U	S	S	U	S	M	S	S
Polythermide	S	M	S	S	S	S	U	/	/	/	/	/	S	U	/	S	S	S	U	U	U	U
Polyester, Glass Thermoset	M	/	S	S	/	S	U	M	S	S	S	S	S	U	/	/	/	M	U	U	U	U
Polycarbonate	U	S	S	U	S	U	U	S	M	M	M	S	S	U	U	S	S	U	U	U	U	U
Polyallomer	S	S	S	S	S	S	M	S	S	S	M	S	S	M	U	S	S	U	S	U	U	S
PET ¹ , Polyclear™, Clear Crimp™	U	M	S	S	S	/	U	S	S	/	U	S	S	U	U	S	S	U	U	U	U	U
Nylon	S	S	S	S	S	S	/	U	S	S	S	S	S	U	/	S	S	U	S	S	S	S
Noryl™	S	S	S	S	S	S	S	S	S	/	U	/	/	U	/	S	S	S	U	U	U	U
Neoprene	U	M	S	S	S	S	S	S	S	M	M	/	/	U	/	S	M	S	U	U	U	U
Glass	S	S	S	S	S	S	M	S	S	/	S	/	/	S	/	S	S	S	S	S	S	S
EPDM rubber	S	/	/	/	S	/	/	/	S	S	U	S	/	U	/	/	S	/	S	U	S	S
Delrin™	S	S	S	S	S	M	M	S	S	M	S	S	M	U	U	S	S	M	S	S	M	M
Composite Carbon Fiber/Epoxy	S	S	S	S	S	S	/	S	S	M	S	S	S	U	/	/	S	M	S	S	S	S
Polyurethane Rotor Paint	S	S	S	S	S	S	/	S	S	S	S	S	S	/	/	/	S	S	S	M	S	S
Cellulose Acetate Butyrate	U	/	/	S	/	S	U	/	S	/	S	U	S	U	U	/	/	U	U	U	U	U
Buna N	M	M	S	S	S	S	M	S	U	S	S	S	M	U	U	S	S	U	U	U	U	U
Anodic Coating for Aluminum	M	S	U	U	U	U	U	U	/	/	/	/	U	/	S	S	S	S	U	U	U	S
Aluminium	M	S	U	M	U	U	U	M	M	M	S	S	U	U	U	M	U	U	U	U	U	S
S	Satisfactory																					
M	Moderate attack, may be satisfactory for use in centrifuge depending on length of exposure, speed involved, etc.; suggest testing under actual conditions of use																					
U	Unsatisfactory, not recommended																					
/	Performance unknown; suggest testing, using sample to avoid loss of valuable material																					

MATERIAL	Chemical Compatibility																					
	PERCHLORIC ACID (70%)	PHENOL (5%)	PHENOL (50%)	PHOSPHORIC ACID (10%)	PHOSPHORIC ACID (CONC.)	PHYSIOLOGIC MEDIA (SERUM, URINE)	PICRIC ACID	PYRIDINE (60%)	RUBIDIUM BROMIDE	RUBIDIUM CHLORIDE	SUCROSE	SUCROSE, ALKALINE	SULFOSALICYLIC ACID	NITRIC ACID (10%)	NITRIC ACID (50%)	NITRIC ACID (95%)	HYDROCHLORIC ACID (10%)	HYDROCHLORIC ACID (60%)	SULFURIC ACID (10%)	SULFURIC ACID (50%)	SULFURIC ACID (CONC.)	
Viton™	S	S	S	S	S	S	S	S	U	S	S	S	S	S	S	S	S	M	S	S	S	S
Tygon™	U	M	M	S	/	S	M	U	S	S	S	S	S	S	M	/	S	M	S	M	S	/
Titanium	S	M	U	U	U	S	S	U	S	S	S	S	S	S	S	S	M	U	U	U	U	U
Stainless Steel	U	M	U	M	M	S	M	U	M	M	S	M	U	S	S	S	U	U	U	U	U	U
Silicone Rubber	U	U	U	U	U	S	U	S	S	S	S	S	S	M	U	U	S	M	U	U	U	U
Rulon A™, Teflon™	S	S	S	S	S	S	S	S	S	S	S	S	S	S	S	S	S	S	S	S	S	S
Polyvynil Chloride	M	U	U	S	M	S	U	U	S	S	S	S	S	S	S	U	S	M	S	S	S	M
Polysulfone	U	U	U	S	S	S	S	M	S	S	S	S	/	S	S	U	S	S	S	S	S	U
Polypropylene	M	S	M	S	M	S	S	S	S	S	S	S	S	S	M	M	S	S	S	S	S	S
Polyethylene	M	M	U	S	S	S	S	U	S	S	S	S	S	S	M	U	S	S	S	S	S	M
Polythermide	U	S	S	S	S	S	S	/	/	/	S	S	S	S	M	U	S	S	S	M	U	U
Polyester, Glass Thermoset	U	M	U	S	S	S	U	U	/	/	S	S	/	S	U	U	S	U	S	U	U	U
Polycarbonate	U	U	U	S	M	S	S	U	S	S	S	U	S	S	M	U	S	U	S	U	U	U
Polyallomer	M	S	U	S	M	S	S	M	S	S	S	S	S	S	M	M	S	M	S	S	S	S
PET ¹ , Polyclear™, Clear Crimp™	U	U	U	/	U	S	S	U	S	S	S	S	S	/	U	U	U	U	S	U	U	U
Nylon	U	U	U	U	U	S	U	U	S	S	S	S	U	U	U	U	U	U	U	U	U	U
Noryl™	M	M	M	S	S	S	S	S	S	S	S	S	S	S	U	S	S	M	M	M	M	M
Neoprene	U	U	U	S	M	S	M	S	S	S	S	S	S	U	U	U	S	M	S	S	/	/
Glass	S	S	S	S	/	S	S	U	S	S	S	S	S	S	S	/	S	S	S	S	/	/
EPDM rubber	/	/	/	S	S	/	S	/	/	/	S	/	/	/	/	/	/	/	/	/	/	M
Delrin™	U	M	M	U	U	S	S	U	S	S	S	S	S	U	U	U	U	U	U	U	U	U
Composite Carbon Fiber/Epoxy	U	M	U	S	/	/	M	U	S	S	S	S	S	U	U	U	S	U	U	U	U	U
Polyurethane Rotor Paint	/	S	S	S	/	/	S	S	S	S	S	S	S	S	S	/	S	S	S	S	/	/
Cellulose Acetate Butyrate	/	/	/	S	M	S	/	U	/	/	/	/	S	S	M	U	S	U	U	U	U	U
Buna N	U	U	U	M	M	S	U	U	S	S	S	S	S	U	U	U	M	U	U	U	U	U
Anodic Coating for Aluminum	U	S	S	U	U	S	S	S	S	S	S	U	S	S	S	/	U	U	U	U	U	U
Aluminium	U	U	U	U	U	M	S	U	M	M	M	U	U	U	U	U	U	M	M	M	M	M
CHEMICAL	PERCHLORIC ACID (70%)	PHENOL (5%)	PHENOL (50%)	PHOSPHORIC ACID (10%)	PHOSPHORIC ACID (CONC.)	PHYSIOLOGIC MEDIA (SERUM, URINE)	PICRIC ACID	PYRIDINE (60%)	RUBIDIUM BROMIDE	RUBIDIUM CHLORIDE	SUCROSE	SUCROSE, ALKALINE	SULFOSALICYLIC ACID	NITRIC ACID (10%)	NITRIC ACID (50%)	NITRIC ACID (95%)	HYDROCHLORIC ACID (10%)	HYDROCHLORIC ACID (60%)	SULFURIC ACID (10%)	SULFURIC ACID (50%)	SULFURIC ACID (CONC.)	
S	Satisfactory																					
M	Moderate attack, may be satisfactory for use in centrifuge depending on length of exposure, speed involved, etc.; suggest testing under actual conditions of use																					
U	Unsatisfactory, not recommended																					
/	Performance unknown; suggest testing, using sample to avoid loss of valuable material																					

Index

A

Aerosol-tight Applications 23
Autoclaving 30

C

Care 27
Centrifugation 21
Chemical Compatibility 70
Clamps 38
Cleaning 28
Cleaning Intervals 27
CLINIConic 56
Control Panel 13

D

Directives 38
Disinfection 29
Disposal 31

E

Entering Centrifugation Parameters 19

H

Hematocrit Rotor 69
HIGHConic III 53
How to install a rotor 15
How to Operate a Rotor 15
How to remove a rotor 15

I

Ice Formation 33
Incorrect Loading 17
8 x 50 mL Individually Sealed 68
Information for the Customer Service 34
Intended Use 6
Items Supplied 10

L

List of Centrifuges 35
List of Rotors 35
Load the Rotor 16
Location 10

M

M10 48
Mains Connection 12
Mains Supply 39
Maintenance 27
Maximum Loading 18
Mechanical Emergency Lid Release 32
MicroClick 18 x 5 58
MicroClick 24 x 2 60
MicroClick 30 x 2 62

Microliter 48 x 2 64
MT-12 51

O

Open / Close the Centrifuge Lid 14
Operation 13

P

8 x 8 PCR Strip 66
Power on / off 14

R

Refrigerants 39
Rotor Specifications 40

S

Safety Instructions 7
Service 30
Shipping 30
Short-term Centrifugation 22
Standards 38
Storage 13

T

Technical Data 36
Technical Specifications 35
Transport and Set Up 10
Troubleshooting 32
Troubleshooting by Guide 33
TX-100 46
TX-100S 44
TX-150 40

U

Unpacking 10



en



Thermo Electron LED GmbH
Zweigniederlassung Osterode
Am Kalkberg, 37520 Osterode am Harz
Germany



Thermo Scientific SL 8
Thermo Scientific SL 8R



50143237 is the original instruction manual.

thermofisher.com

© 2014–2022 Thermo Fisher Scientific Inc. All rights reserved.

All trademarks are the property of Thermo Fisher Scientific Inc. and its subsidiaries unless otherwise indicated. Not all products are available in all countries. Please consult your local sales representative for details.

Shown pictures within the manual are examples and may differ considering the set parameters and language.

Australia
+61 39757 4300

Austria
+43 1 801 40 0

Belgium
+32 53 73 42 41

China
+800 810 5118
or +400 650 5118

France
+33 2 2803 2180

Germany national toll free 0800 1 536 376

Germany international

+49 6184 90 6000

India
+91 22 6716 2200

Italy
+39 02 95059 552

Japan
+81 3 5826 1616

Netherlands
+31 76 579 55 55

New Zealand
+64 9 980 6700

Nordic/Baltic/CIS countries
+358 10 329 2200

Russia
+7 812 703 42 15

Spain/Portugal
+34 93 223 09 18

Switzerland
+41 44 454 12 12

UK/Ireland
+44 870 609 9203

USA/Canada
+1 866 984 3766

Other Asian Countries
+852 2885 4613

Countries not listed
+49 6184 90 6000